

TRF0208-SP Radiation-Hardness-Assured (RHA), Near-DC to 11GHz, Fully Differential RF Amplifier

1 Features

- Standard microcircuit drawing (SMD), 5962-24202
- Radiation:
 - Total ionizing dose (TID)
 - Radiation hardness assurance (RHA) up to 100krad (Si) TID
 - Enhanced low dose rate sensitivity (ELDRS) free process
 - High dose rate radiation lot acceptance testing (HDR RLAT) up to 100krad (Si) TID
 - Single event effects (SEE)
 - Single event latch-up (SEL) immune to linear energy transfer (LET) of 75MeV-cm²/mg
 - Single event transient (SET) characterized to LET of 75MeV-cm²/mg
- Space-grade QMLP
 - Lead-free construction
 - Extended temperature range: –55°C to +125°C
- Excellent performance driving RF ADCs
- Fixed power gain of 16dB in single-ended-to-differential mode
- Bandwidth: 11GHz, 3dB
- Gain flatness: 8GHz, 1dB
- OIP3: 36dBm (2GHz), 32dBm (6GHz)
- P1dB: 14.5dBm (2GHz), 11dBm (6GHz)
- NF: 6.8dB (2GHz), 6.8dB (6GHz)
- Gain and phase imbalance: ±0.3dB and ±3°
- Power-down feature
- Single-supply operation: 3.3V
- Active current: 138mA

2 Applications

- RF sampling or GSPS ADC driver
- [Aerospace and defense](#)

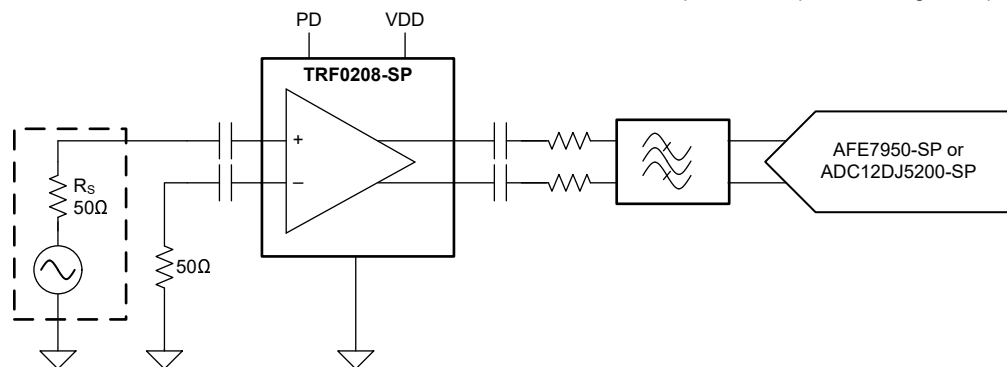

TRF0208-SP Driving a High-Speed ADC

- [Phased array radar](#)
- [Communications payload](#)
- [Radar imaging payload](#)

3 Description

The TRF0208-SP is a very high performance fully differential amplifier (FDA) optimized for radio frequency (RF) applications. This device is excellent for ac-coupled applications that require a single-ended to differential conversion when driving an analog-to-digital converter (ADC) such as the high-performance [AFE7950-SP](#) or [ADC12DJ5200-SP](#). The on-chip matching components simplify printed circuit board (PCB) implementation and provide the highest performance over the usable bandwidth. The device is fabricated using TI's advanced complementary BiCMOS process, and available in a space-saving WQFN-FCRLF package.

The TRF0208-SP operates on a single-rail supply and consumes about 138mA of active current. A power-down feature is available for power savings.

Device Information

PART NUMBER ⁽¹⁾	GRADE	BODY SIZE ⁽²⁾
5962R2420201PXE ⁽³⁾	Flight-grade QMLP-RHA	2.00mm × 2.00mm Mass = 7.558mg
TRF0208RPVTSP/EM	Engineering samples ⁽⁴⁾	

- (1) For more information, see [Section 10](#).
- (2) The body size (length × width) is a nominal value and does not include pins. Mass is a nominal value.
- (3) Product preview.
- (4) These units are intended for engineering evaluation only. These samples are processed to a non-compliant flow. These units are not for qualification, production, radiation testing, or flight use. Parts are not warranted for performance over the full MIL specified temperature range, or operating life.



Table of Contents

1 Features	1	7 Application and Implementation	16
2 Applications	1	7.1 Application Information.....	16
3 Description	1	7.2 Typical Applications.....	18
4 Pin Configuration and Functions	3	7.3 Power Supply Recommendations.....	21
5 Specifications	4	7.4 Layout.....	21
5.1 Absolute Maximum Ratings.....	4	8 Device and Documentation Support	22
5.2 ESD Ratings.....	4	8.1 Device Support.....	22
5.3 Recommended Operating Conditions.....	4	8.2 Documentation Support	22
5.4 Thermal Information.....	4	8.3 Receiving Notification of Documentation Updates....	22
5.5 Electrical Characteristics.....	5	8.4 Support Resources.....	22
5.6 Typical Characteristics.....	7	8.5 Trademarks.....	22
6 Detailed Description	14	8.6 Electrostatic Discharge Caution.....	22
6.1 Overview.....	14	8.7 Glossary.....	22
6.2 Functional Block Diagram.....	14	9 Revision History	22
6.3 Feature Description.....	15	10 Mechanical, Packaging, and Orderable Information	22
6.4 Device Functional Modes.....	15		

4 Pin Configuration and Functions

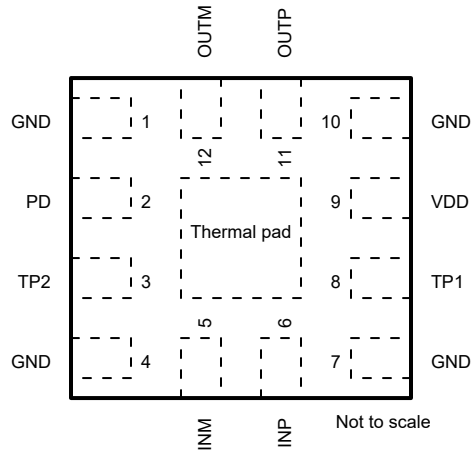

**Figure 4-1. RPV Package,
12-Pin WQFN-FCRLF
(Top View)**

Table 4-1. Pin Functions

PIN		TYPE ⁽¹⁾	DESCRIPTION
NAME	NO.		
GND	1, 4, 7, 10	GND	Ground
INM	5	I	Differential signal input, negative
INP	6	I	Differential signal input, positive
OUTM	12	O	Differential signal output, negative
OUTP	11	O	Differential signal output, positive
PD	2	I	Power-down signal. Supports 1.8V and 3.3V logic. 0 = Chip enabled 1 = Power down
TP1	8	—	Test pin. Short to ground.
TP2	3	—	Test pin. Short to ground.
VDD	9	P	3.3V supply
Thermal pad	Pad	—	Thermal pad. Connect to ground on board.

(1) I = input, O = output, P = power, GND = ground

5 Specifications

5.1 Absolute Maximum Ratings

over operating free-air temperature range (unless otherwise noted)⁽¹⁾

		MIN	MAX	UNIT
V _{DD}	Supply voltage	−0.3	3.7	V
INP, INM	Input pin power		20 ⁽²⁾	dBm
V _{PD}	Power-down pin voltage	−0.3	3.7 ⁽³⁾	V
T _J	Junction temperature		150	°C
T _{stg}	Storage temperature	−65	150	°C

- (1) Operation outside the *Absolute Maximum Ratings* may cause permanent device damage. *Absolute Maximum Ratings* do not imply functional operation of the device at these or any other conditions beyond those listed under *Recommended Operating Conditions*. If used outside the *Recommended Operating Conditions* but within the *Absolute Maximum Ratings*, the device may not be fully functional, and this may affect device reliability, functionality, performance, and shorten the device lifetime.
- (2) When V_{DD} = 0V, maximum value is 0dBm.
- (3) When V_{DD} = 0V, maximum value is 0.3V

5.2 ESD Ratings

			VALUE	UNIT
V _(ESD)	Electrostatic discharge	Human body model (HBM), per ANSI/ESDA/JEDEC JS-001, all pins ⁽¹⁾	±1000	V
		Charged device model (CDM), per ANSI/ESDA/JEDEC JS-002, all pins ⁽²⁾	±250	

- (1) JEDEC document JEP155 states that 500V HBM allows safe manufacturing with a standard ESD control process.
- (2) JEDEC document JEP157 states that 250V CDM allows safe manufacturing with a standard ESD control process.

5.3 Recommended Operating Conditions

over operating free-air temperature range (unless otherwise noted)

		MIN	NOM	MAX	UNIT
V _{DD}	Supply voltage	3.2	3.3	3.45	V
T _A	Ambient free-air temperature	−55	25		°C
T _J	Junction temperature			125	°C

5.4 Thermal Information

THERMAL METRIC ⁽¹⁾		TRF0208-SP		UNIT
		RPV (WQFN-FCRLF)		
		12 PINS		
R _{θJA}	Junction-to-ambient thermal resistance	66.9		°C/W
R _{θJC(top)}	Junction-to-case (top) thermal resistance	64.3		°C/W
R _{θJB}	Junction-to-board thermal resistance	17.4		°C/W
Ψ _{JT}	Junction-to-top characterization parameter	1.7		°C/W
Ψ _{JB}	Junction-to-board characterization parameter	17.2		°C/W
R _{θJC(bot)}	Junction-to-case (bottom) thermal resistance	9.0		°C/W

- (1) For more information about traditional and new thermal metrics, see the [Semiconductor and IC Package Thermal Metrics](#) application report.

5.5 Electrical Characteristics

at $T_A = 25^\circ\text{C}$, $V_{DD} = 3.3\text{V}$, 50Ω single-ended input, and 100Ω differential output (unless otherwise noted)

PARAMETER		TEST CONDITIONS	MIN	TYP	MAX	UNIT
AC PERFORMANCE						
SSBW	Small-signal 3dB bandwidth	$V_O = 0.1V_{PP}$		11		GHz
LSBW	Large-signal 3dB bandwidth	$V_O = 1V_{PP}$		11		GHz
1dB BW	Bandwidth for 1dB flatness			8		GHz
S21	Power gain	$f = 2\text{GHz}$		16		dB
S11	Input return loss	$f = 10\text{MHz to } 8\text{GHz}$		-10		dB
S12	Reverse isolation	$f = 2\text{GHz}$		-35		dB
Imb _{GAIN}	Gain imbalance	$f = 10\text{MHz to } 8\text{GHz}$		± 0.3		dB
Imb _{PHASE}	Phase imbalance	$f = 10\text{MHz to } 8\text{GHz}$		± 3		degrees
CMRR	Common-mode rejection ratio ⁽¹⁾	$f = 2\text{GHz}$		-45		dB
HD2	Second-order harmonic distortion	$f = 0.5\text{GHz}, P_O = 3\text{dBm}$		-70		dBc
		$f = 2\text{GHz}, P_O = 3\text{dBm}$		-65		
		$f = 6\text{GHz}, P_O = 3\text{dBm}$		-52		
		$f = 8\text{GHz}, P_O = 3\text{dBm}$		-50		
HD3	Third-order harmonic distortion	$f = 0.5\text{GHz}, P_O = 3\text{dBm}$		-68		dBc
		$f = 2\text{GHz}, P_O = 3\text{dBm}$		-63		
		$f = 6\text{GHz}, P_O = 3\text{dBm}$		-54		
		$f = 8\text{GHz}, P_O = 3\text{dBm}$		-60		
IMD2	Second-order intermodulation distortion	$f = 0.5\text{GHz}, P_O = -4\text{dBm per tone (10MHz spacing)}$		-72		dBc
		$f = 2\text{GHz}, P_O = -4\text{dBm per tone (10MHz spacing)}$		-64		
		$f = 6\text{GHz}, P_O = -4\text{dBm per tone (10MHz spacing)}$		-54		
		$f = 8\text{GHz}, P_O = -4\text{dBm per tone (10MHz spacing)}$		-48		
IMD3	Third-order intermodulation distortion	$f = 0.5\text{GHz}, P_O = -4\text{dBm per tone (10MHz spacing)}$		-77		dBc
		$f = 2\text{GHz}, P_O = -4\text{dBm per tone (10MHz spacing)}$		-80		
		$f = 6\text{GHz}, P_O = -4\text{dBm per tone (10MHz spacing)}$		-70		
		$f = 8\text{GHz}, P_O = -4\text{dBm per tone (10MHz spacing)}$		-48		
OP1dB	Output 1dB compression point	$f = 0.5\text{GHz}$		11		dBm
		$f = 2\text{GHz}$		14.5		
		$f = 6\text{GHz}$		11		
		$f = 8\text{GHz}$		7.5		
OIP2	Output second-order intercept point	$f = 0.5\text{GHz}, P_O = -4\text{dBm per tone (10MHz spacing)}$		68		dBm
		$f = 2\text{GHz}, P_O = -4\text{dBm per tone (10MHz spacing)}$		60		
		$f = 6\text{GHz}, P_O = -4\text{dBm per tone (10MHz spacing)}$		50		
		$f = 8\text{GHz}, P_O = -4\text{dBm per tone (10MHz spacing)}$		45		

5.5 Electrical Characteristics (continued)

at $T_A = 25^\circ\text{C}$, $V_{DD} = 3.3\text{V}$, 50Ω single-ended input, and 100Ω differential output (unless otherwise noted)

PARAMETER		TEST CONDITIONS	MIN	TYP	MAX	UNIT
OIP3	Output third-order intercept point	$f = 0.5\text{GHz}$, $P_o = -4\text{dBm}$ per tone (10MHz spacing)		34		dBm
		$f = 2\text{GHz}$, $P_o = -4\text{dBm}$ per tone (10MHz spacing)		36		
		$f = 4\text{GHz}$, $P_o = -4\text{dBm}$ per tone (10MHz spacing)		35		
		$f = 6\text{GHz}$, $P_o = -4\text{dBm}$ per tone (10MHz spacing)		32		
		$f = 8\text{GHz}$, $P_o = -4\text{dBm}$ per tone (10MHz spacing)		21		
NF	Noise Figure	$f = 0.5\text{GHz}$		6.5		dB
		$f = 2\text{GHz}$		6.8		
		$f = 6\text{GHz}$		6.8		
		$f = 8\text{GHz}$		8.5		
IMPEDANCE						
Z_{O-DIFF}	Differential output impedance	$f = \text{dc}$ (internal to the device)		3		Ω
Z_{IN}	Single-ended input impedance	INM pin terminated with 50Ω		50		Ω
TRANSIENT						
V_{OMAX}	Maximum output voltage (differential)			2		V_{PP}
V_{OSAT}	Output saturated voltage level (differential)	$f = 2\text{GHz}$		3.9		V_{PP}
t_{REC}	Overdrive recovery time	Using a $-0.5V_P$ input pulse of 2ns duration		0.2		ns
POWER SUPPLY						
I_{QA}	Active current	Current on V_{DD} pin, PD = 0		138		mA
I_{QPD}	Power-down quiescent current	Current on V_{DD} pin, PD = 1		7		mA
ENABLE						
V_{PDHIGH}	PD pin logic high		1.45			V
V_{PDLLOW}	PD pin logic low				0.8	V
I_{PDBIAS}	PD bias current (current on PD pin)	PD = high (1.8V logic)		50	100	μA
		PD = high (3.3V logic)		200	250	
C_{PD}	PD pin capacitance			2		pF
t_{ON}	Turn-on time	50% V_{PD} to 90% RF		200		ns
t_{OFF}	Turn-off time	50% V_{PD} to 10% RF		50		ns

(1) Calculated using the formula $(S_{21}-S_{31})/(S_{21}+S_{31})$. Port-1: INP, Port-2: OUTP, Port-3: OUTM.

5.6 Typical Characteristics

at $T_A = 25^\circ\text{C}$, temperature curves specify ambient temperature, $V_{DD} = 3.3\text{V}$, 50Ω single-ended input, and 100Ω differential output (unless otherwise noted)

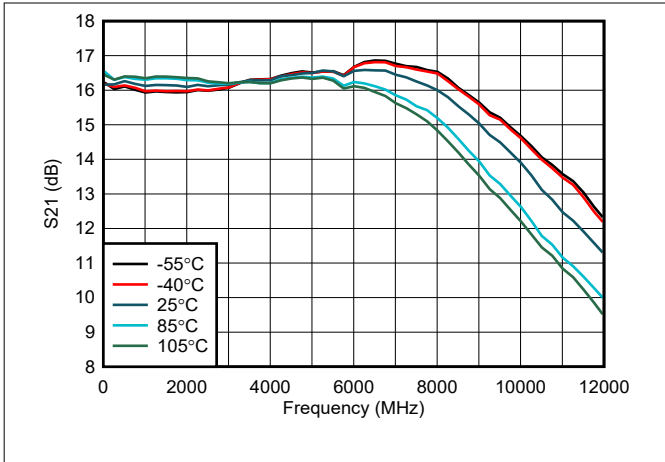

Figure 5-1. Power Gain Across Temperature

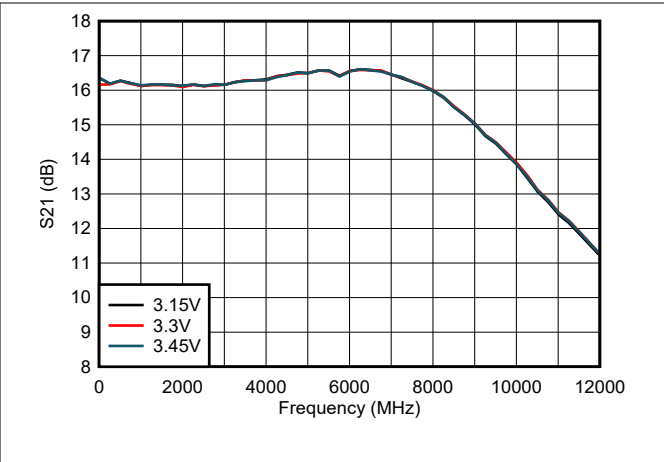

Figure 5-2. Power Gain Across V_{DD}

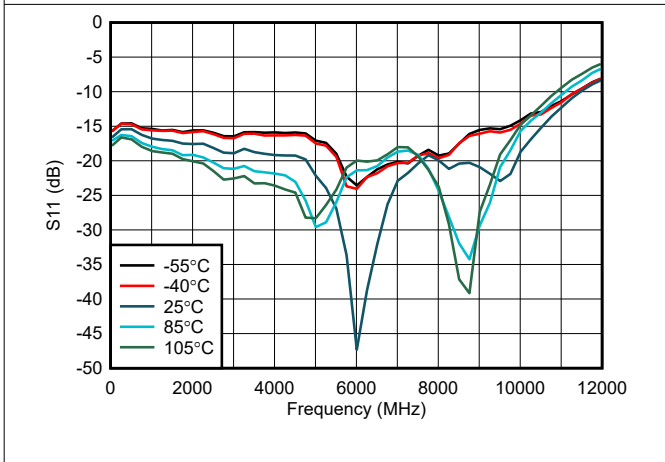

Figure 5-3. Return Loss Across Temperature

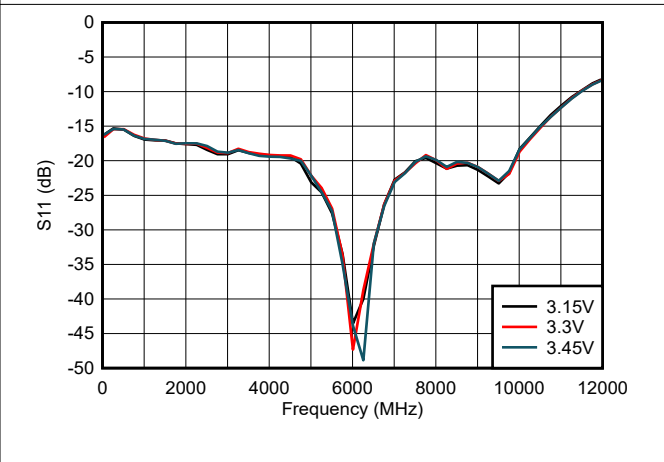

Figure 5-4. Return Loss Across V_{DD}

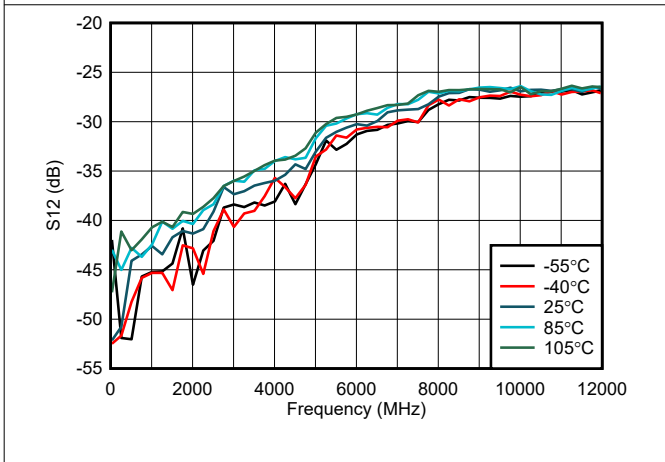

Figure 5-5. Reverse Isolation Across Temperature

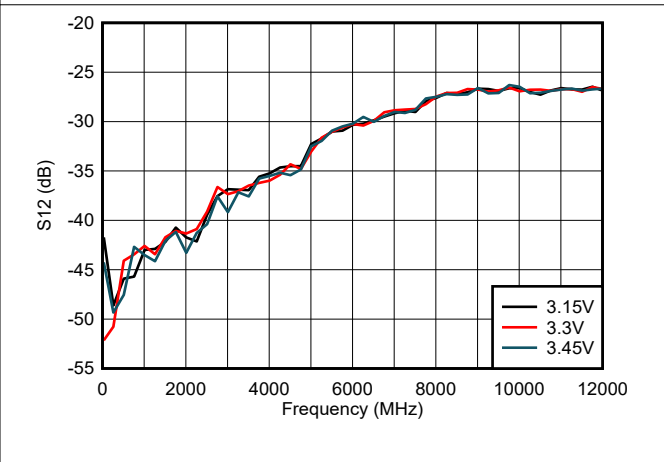
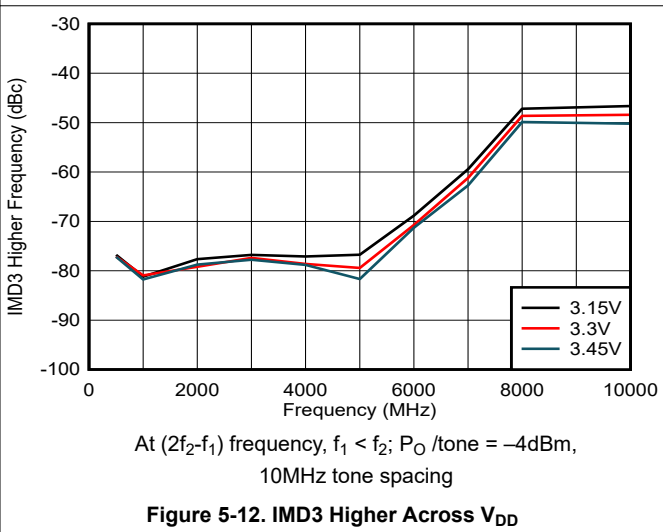
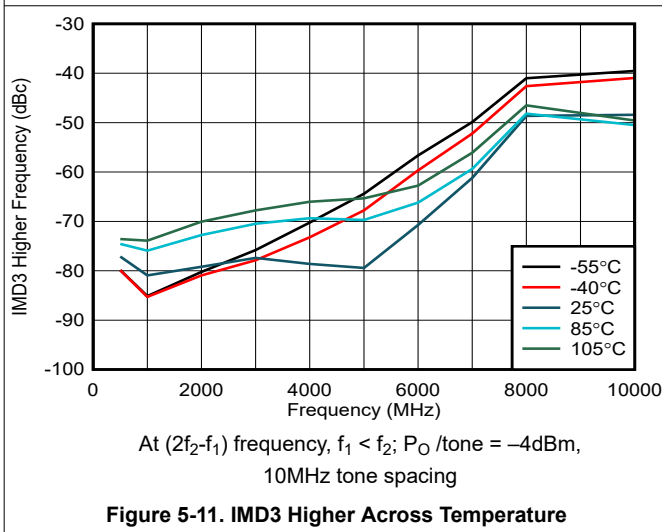
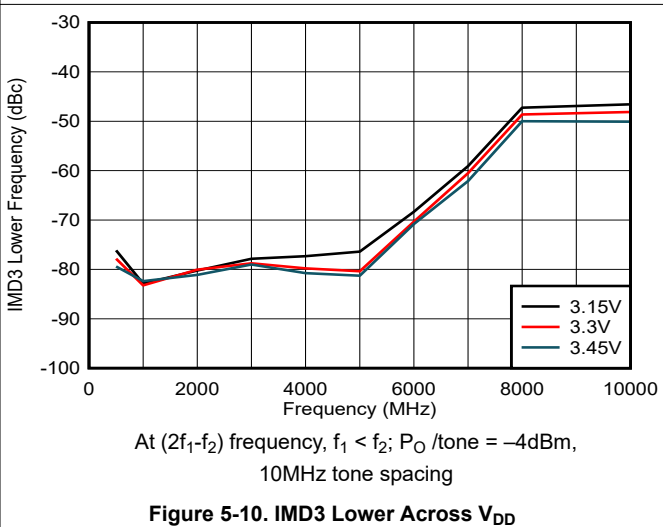
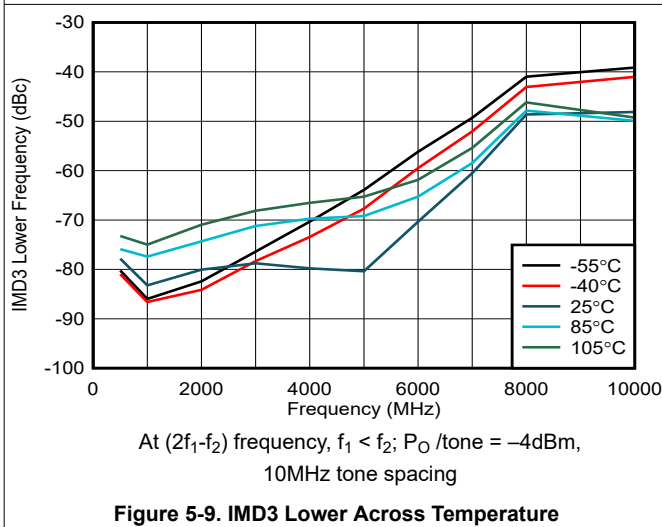
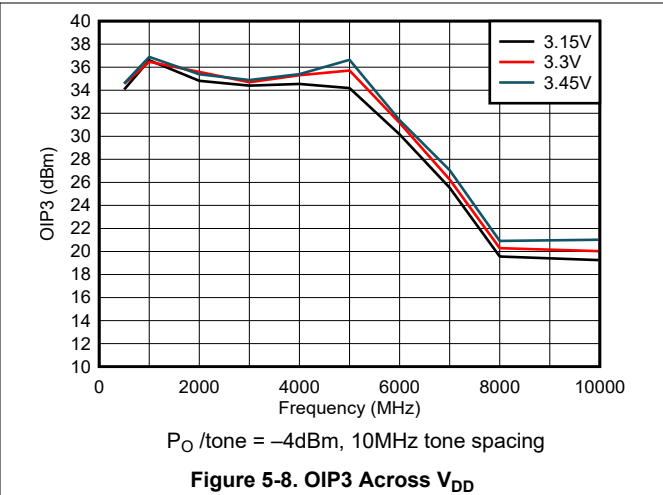
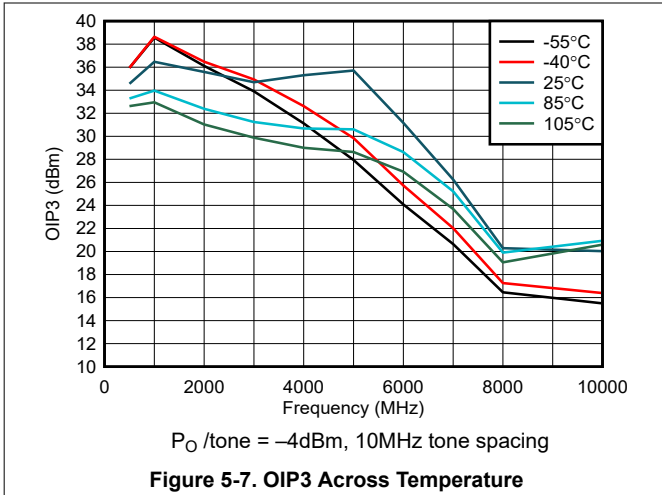

Figure 5-6. Reverse Isolation Across V_{DD}

5.6 Typical Characteristics (continued)

at $T_A = 25^\circ\text{C}$, temperature curves specify ambient temperature, $V_{DD} = 3.3\text{V}$, 50Ω single-ended input, and 100Ω differential output (unless otherwise noted)



5.6 Typical Characteristics (continued)

at $T_A = 25^\circ\text{C}$, temperature curves specify ambient temperature, $V_{DD} = 3.3\text{V}$, 50Ω single-ended input, and 100Ω differential output (unless otherwise noted)

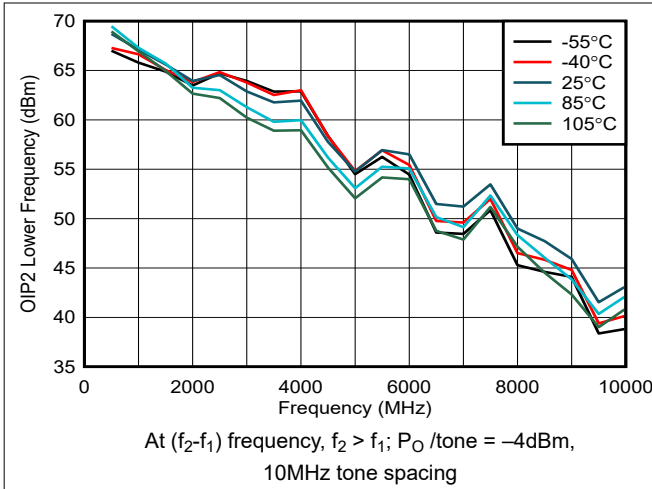

Figure 5-13. OIP2 Lower Across Temperature

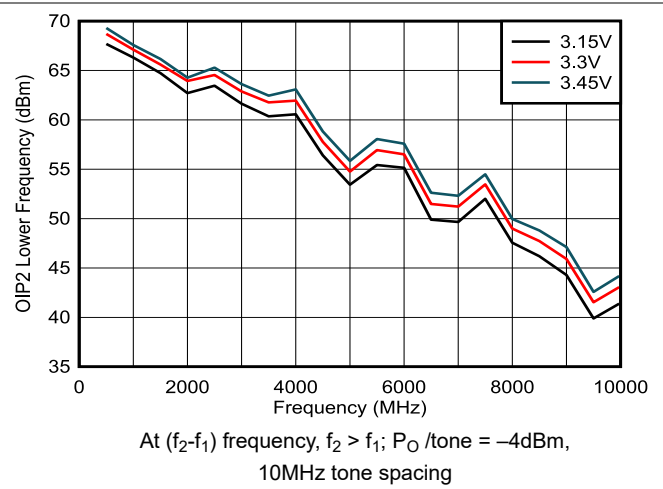

Figure 5-14. OIP2 Lower Across V_{DD}

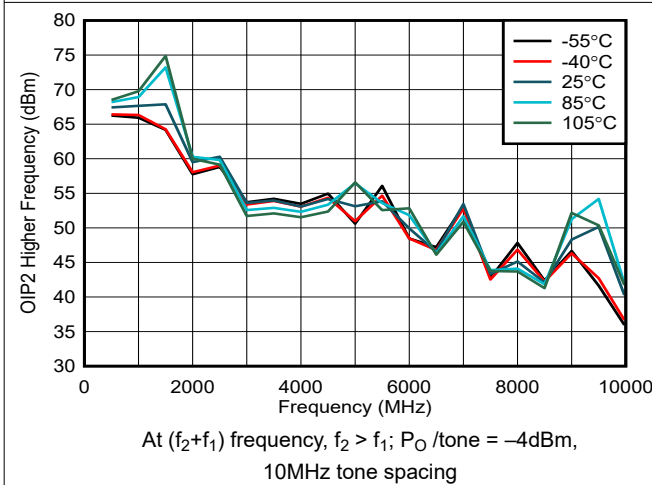

Figure 5-15. OIP2 Higher Across Temperature

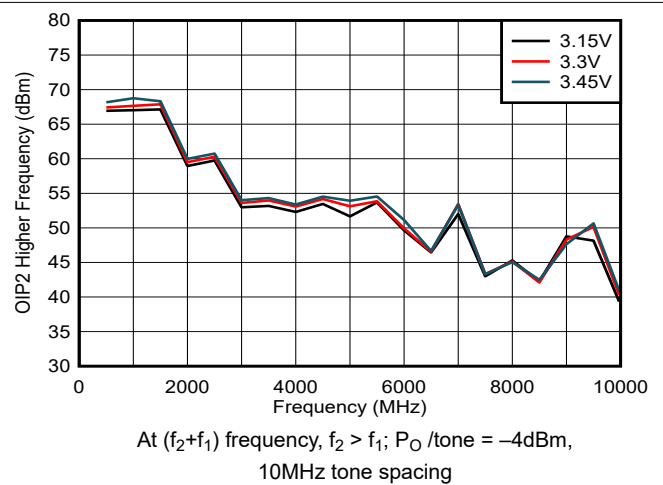

Figure 5-16. OIP2 Higher Across V_{DD}

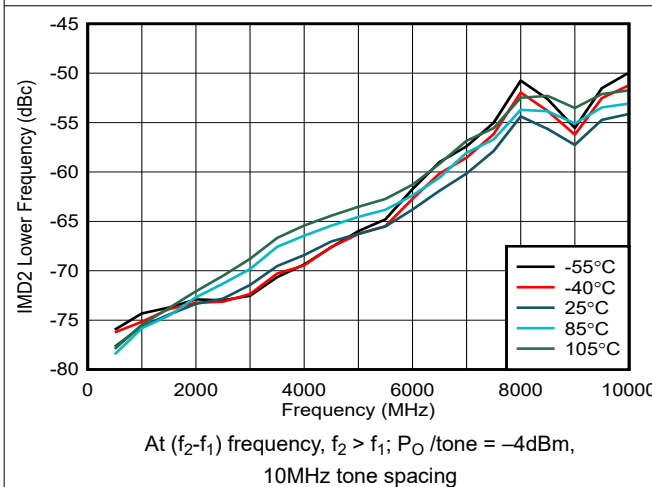

Figure 5-17. IMD2 Lower Across Temperature

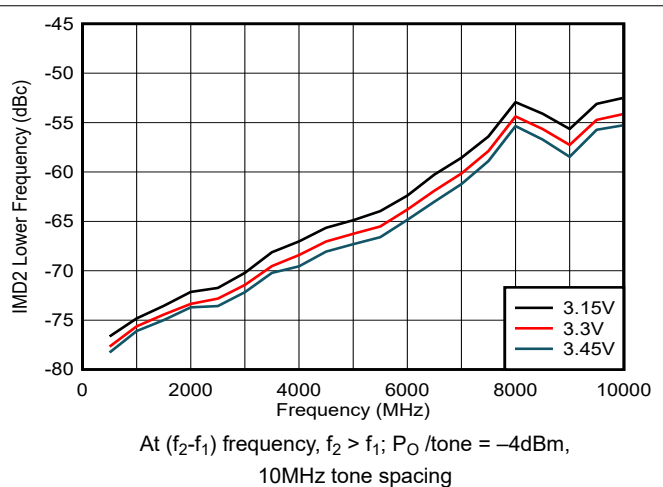

Figure 5-18. IMD2 Lower Across V_{DD}

5.6 Typical Characteristics (continued)

at $T_A = 25^\circ\text{C}$, temperature curves specify ambient temperature, $V_{DD} = 3.3\text{V}$, 50Ω single-ended input, and 100Ω differential output (unless otherwise noted)

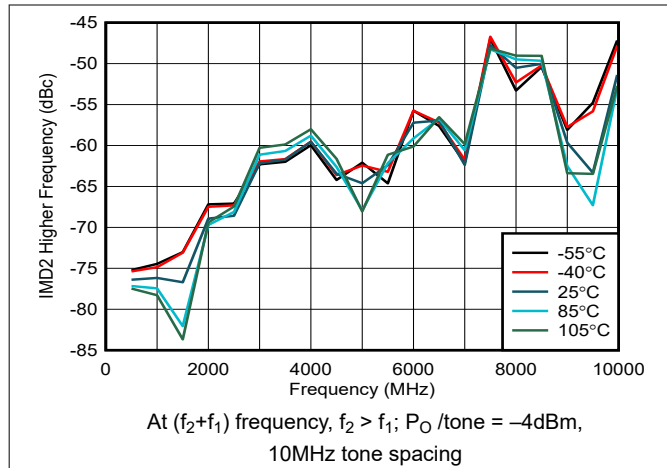

Figure 5-19. IMD2 Higher Across Temperature

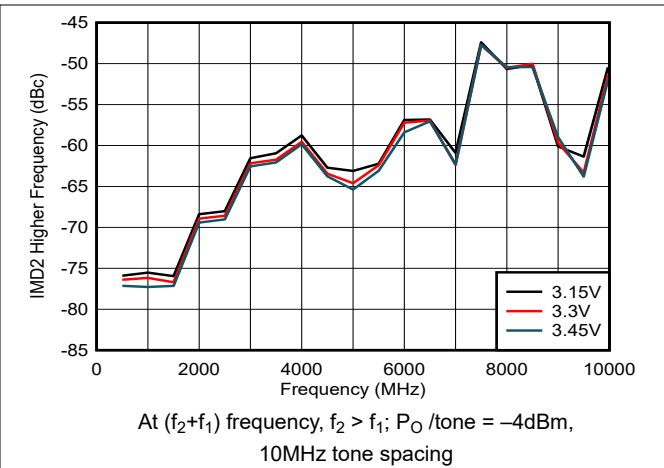

Figure 5-20. IMD2 Higher Across V_{DD}

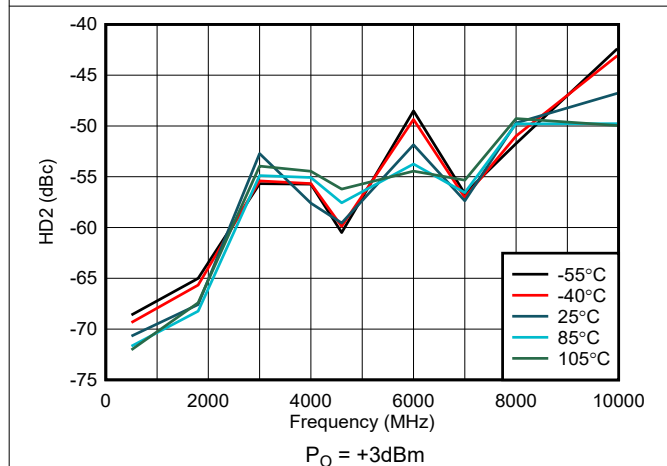

Figure 5-21. HD2 Across Temperature

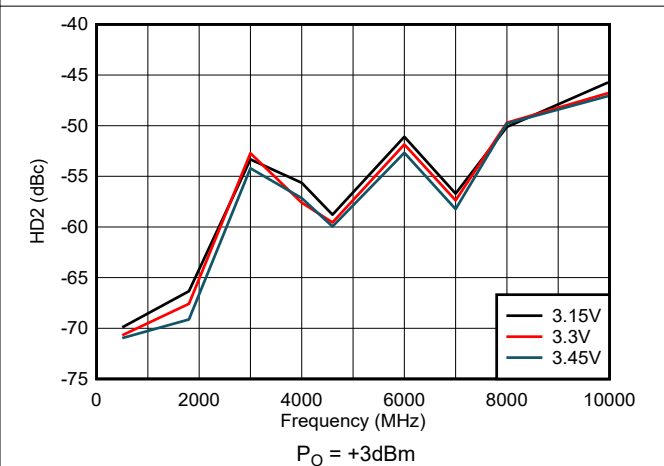

Figure 5-22. HD2 Across V_{DD}

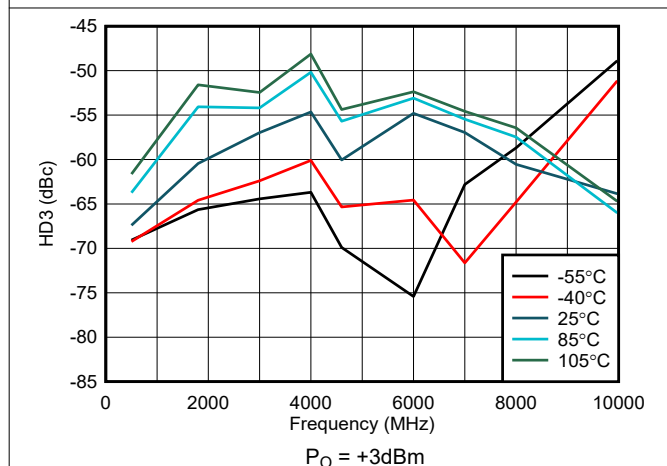

Figure 5-23. HD3 Across Temperature

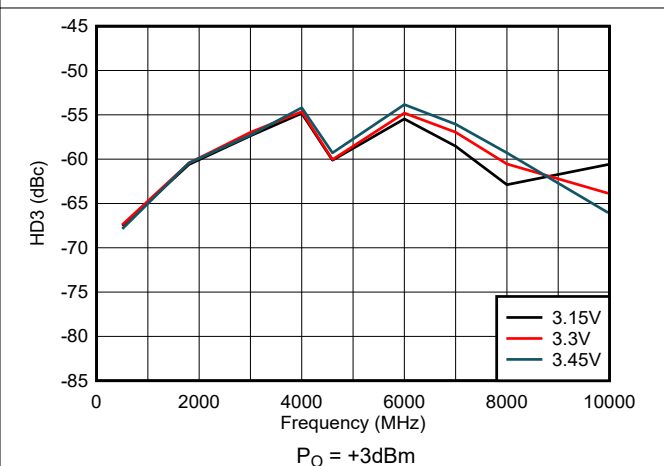
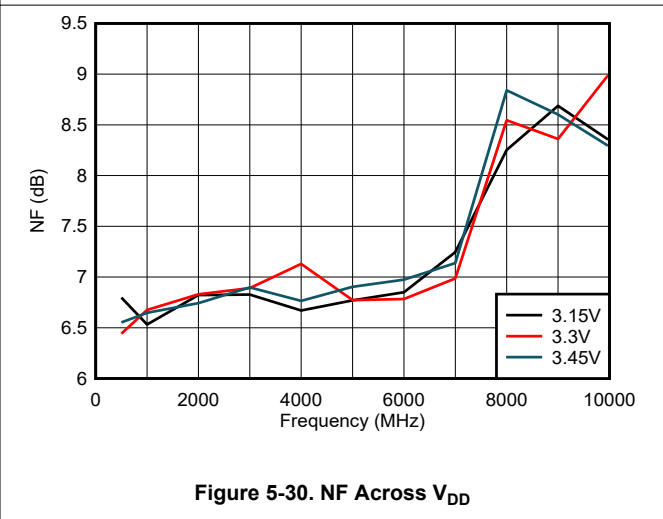
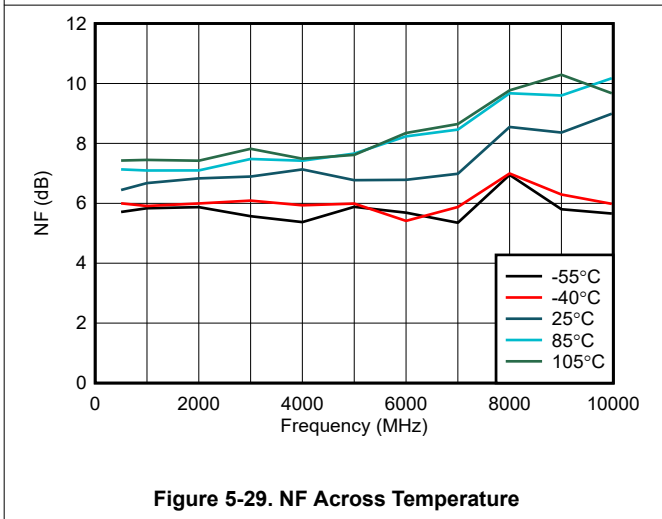
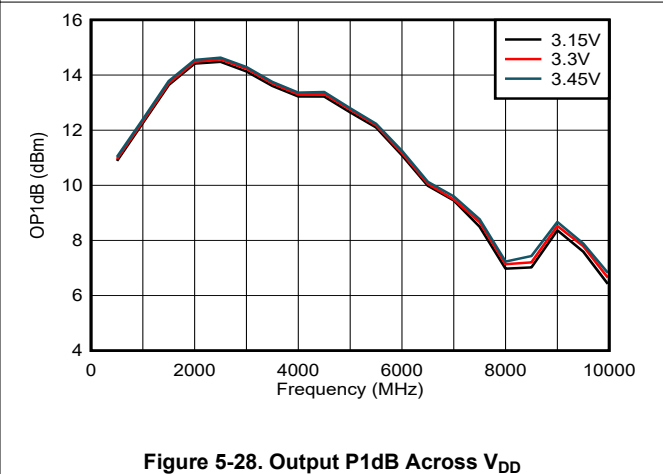
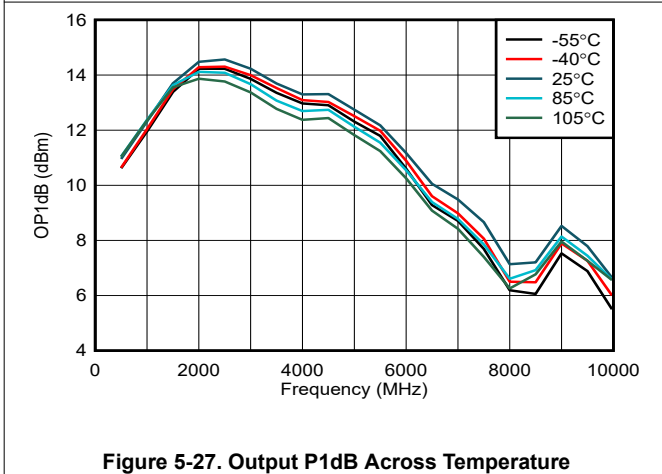
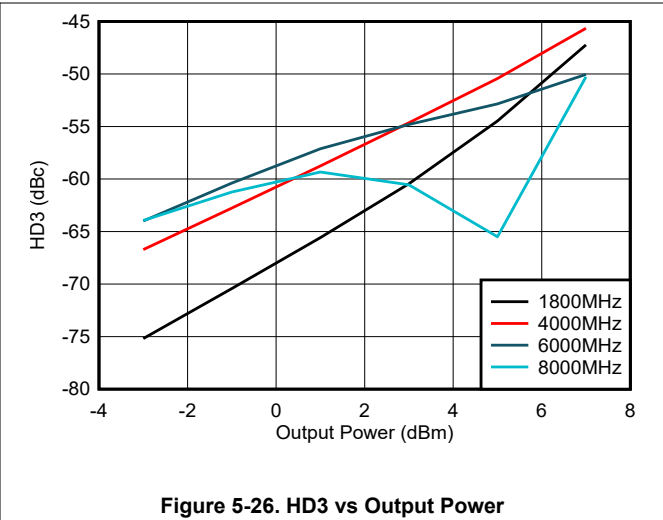
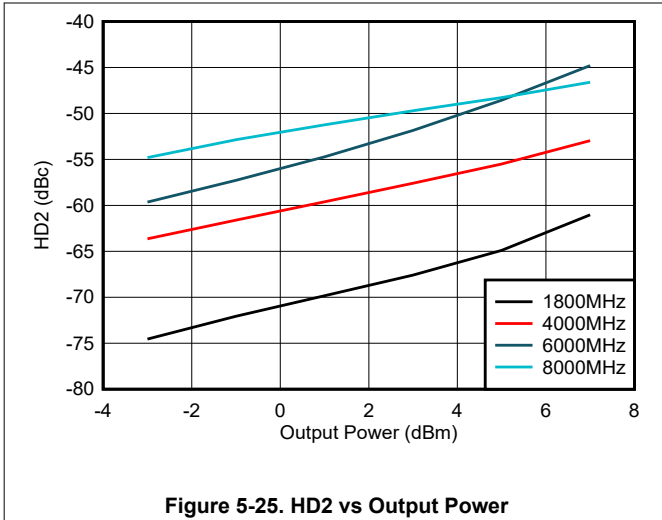

Figure 5-24. HD3 Across V_{DD}

5.6 Typical Characteristics (continued)

at $T_A = 25^\circ\text{C}$, temperature curves specify ambient temperature, $V_{DD} = 3.3\text{V}$, 50Ω single-ended input, and 100Ω differential output (unless otherwise noted)



5.6 Typical Characteristics (continued)

at $T_A = 25^\circ\text{C}$, temperature curves specify ambient temperature, $V_{DD} = 3.3\text{V}$, 50Ω single-ended input, and 100Ω differential output (unless otherwise noted)

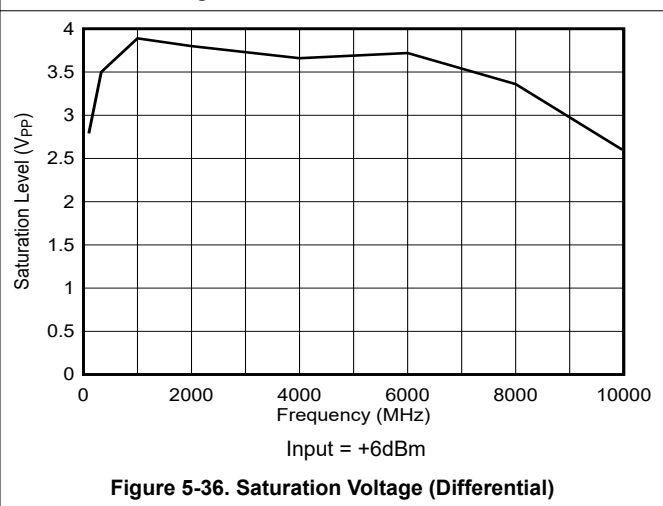
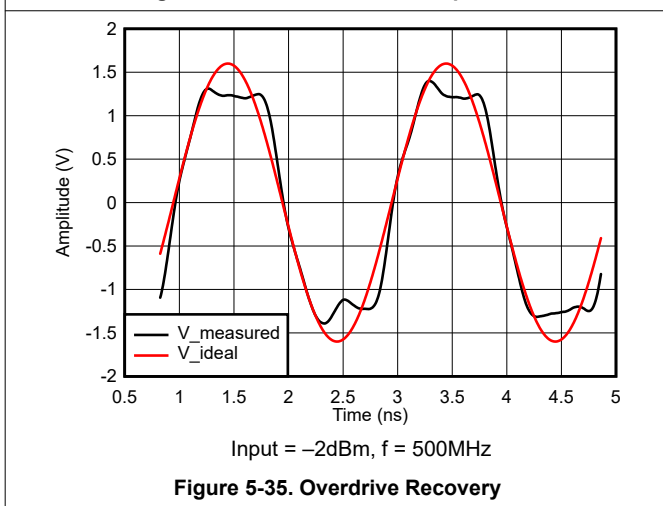
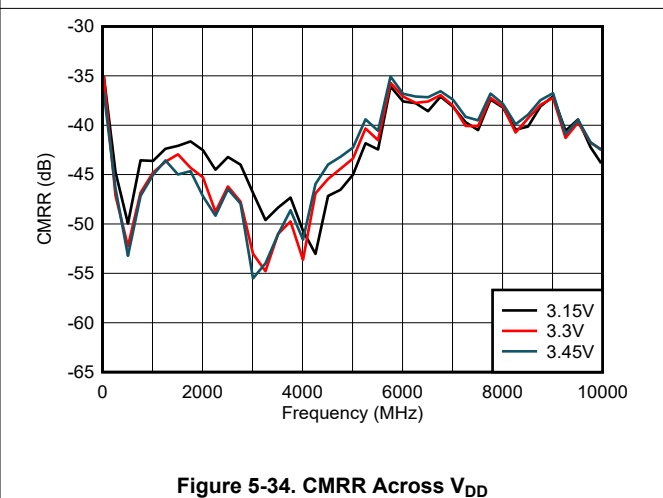
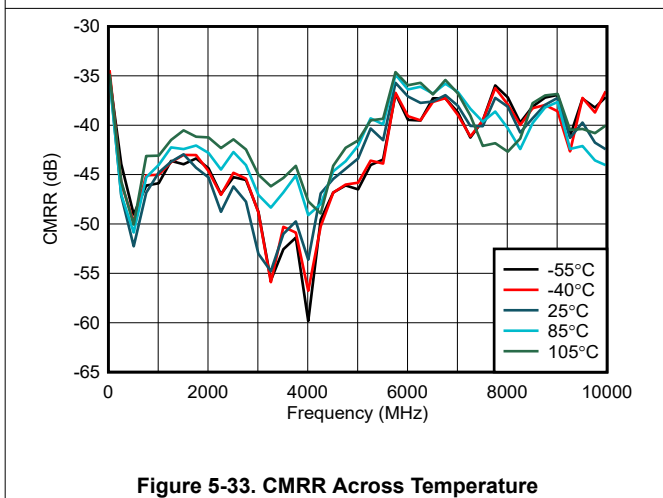
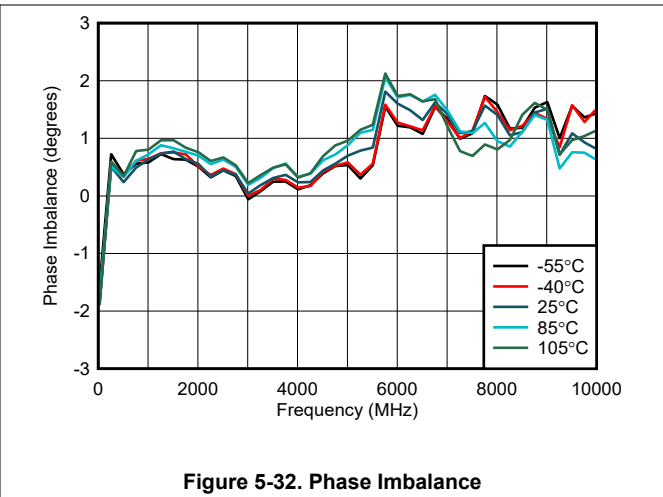
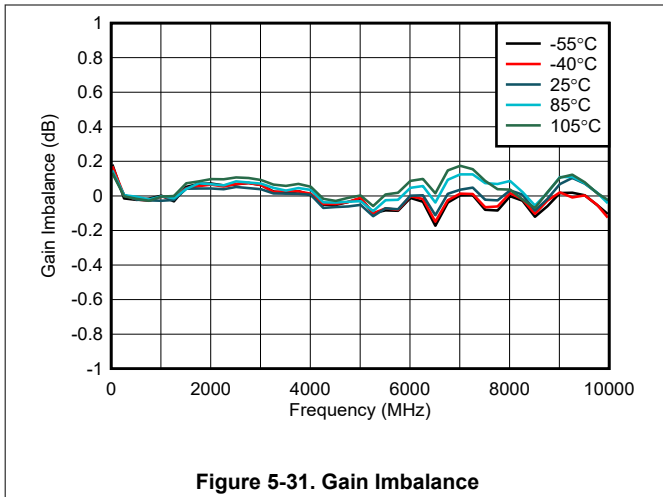

5.6 Typical Characteristics (continued)

at $T_A = 25^\circ\text{C}$, temperature curves specify ambient temperature, $V_{DD} = 3.3\text{V}$, 50Ω single-ended input, and 100Ω differential output (unless otherwise noted)

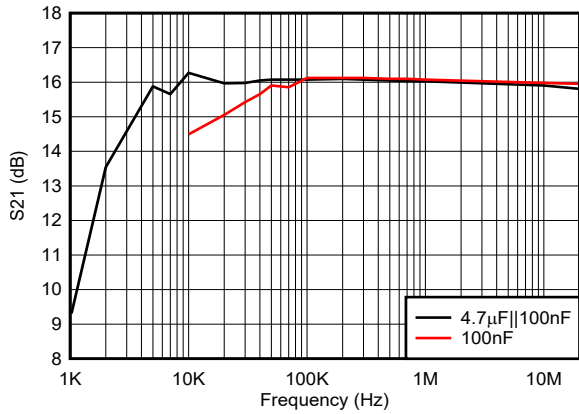

Low frequency cut-off as a function of ac-coupling cap

Figure 5-37. Low Frequency Gain Response

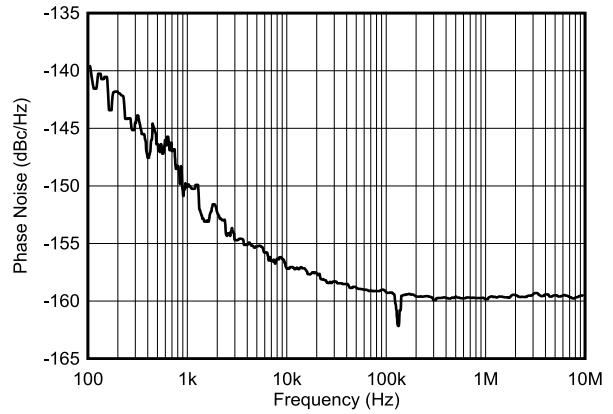

$f = 1\text{GHz}$, $P_{IN} = -10\text{dBm}$

Figure 5-38. Additive (Residual) Phase Noise

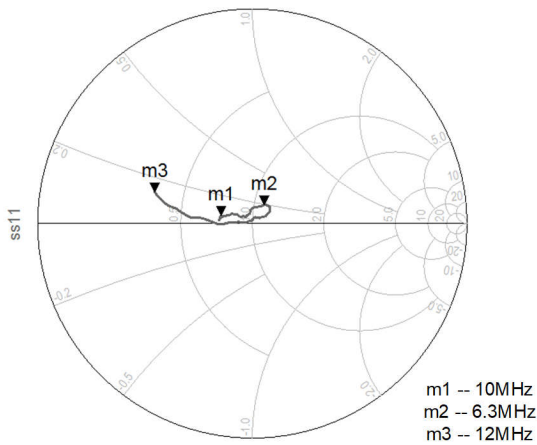

Frequency (10.00MHz to 12.00GHz)

Figure 5-39. Single-Ended S11

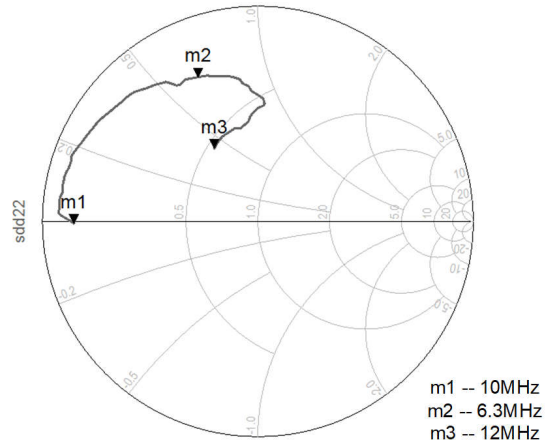

Frequency (10.00MHz to 12.00GHz)

Figure 5-40. Differential S22

6 Detailed Description

6.1 Overview

The TRF0208-SP is a very high-performance amplifier optimized for radio frequency (RF) and intermediate frequency (IF) with signal bandwidths up to 11GHz. The device is designed for ac-coupled applications that require a single-ended-to-differential conversion when driving an analog-to-digital converter (ADC). The low frequency response is limited only by the ac-coupling capacitor on the PCB. If the lowest signal frequency is $>100\text{kHz}$, use 100nF ac-coupling capacitors. If the lowest signal frequency is 9kHz, use a 4.7 μF capacitor in parallel with 100nF capacitor on each input-output pin. The device has a two-stage architecture and provides approximately 16dB of gain in single-ended-to-differential mode, when driving a differential 100 Ω load for single-ended inputs driven from a 50 Ω source. This device also works as a fully-differential amplifier.

This device does not require any pullup or pulldown components on the PCB, and thereby simplifies the layout and provides the highest performance over the entire bandwidth.

The input and output are ac coupled. The TRF0208-SP is powered with 3.3V supply. A power-down feature is also available.

6.2 Functional Block Diagram

The following figure shows the functional block diagram of TRF0208-SP. The device essentially has two stages with a voltage-feedback configuration.

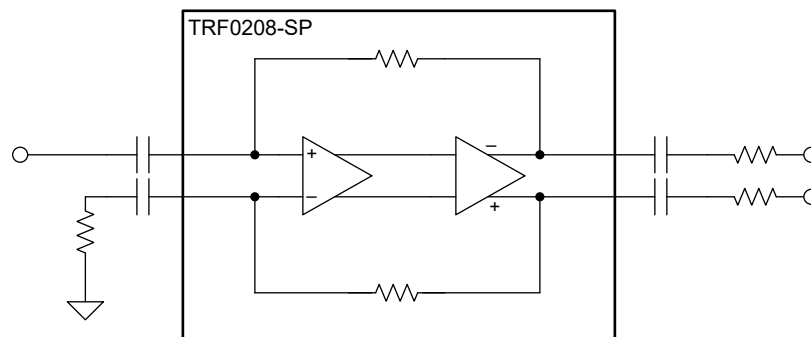

6.3 Feature Description

6.3.1 Fully-Differential Amplifier

The TRF0208-SP is a voltage-feedback fully differential amplifier (FDA) with a fixed gain by architecture. The TRF0208-SP operates as a single-ended to differential amplifier by terminating the INM pin with a 50Ω resistor and driving the INP pin directly with no external components.

This amplifier has nonlinearity cancellation circuits that provide excellent linearity performance over a wide range of frequencies.

The output of the amplifier has a low dc impedance. Therefore, if required, the output of the amplifier can be matched to a load by adding the appropriate series resistors or attenuator pad.

6.3.2 Single Supply Operation

The TRF0208-SP operates on a single 3.3V supply. The input and output bias voltages are set internally. Therefore, ac-couple the signal path on the board at all four RF input and output pins. Single-supply operation simplifies the board design.

6.4 Device Functional Modes

TRF0208-SP has two functional modes: active and power-down. The functional modes are controlled by the PD pin as described below.

6.4.1 Power Down Mode

The device features a power-down option. The PD pin is used to power down the amplifier. This pin supports both 1.8V and 3.3V digital logic, and is referenced to ground. A logic 1 turns the device off and places the device into a low-quiescent-current state.

When disabled, the signal path is still present through the internal circuits. Input signals applied to a disabled device still appear at the outputs at a lower level through this path, as is the case for any disabled feedback amplifier.

7 Application and Implementation

Note

Information in the following applications sections is not part of the TI component specification, and TI does not warrant its accuracy or completeness. TI's customers are responsible for determining suitability of components for their purposes, as well as validating and testing their design implementation to confirm system functionality.

7.1 Application Information

7.1.1 Driving a High-Speed ADC

A common application for the TRF0208-SP is driving a high-speed ADC that has a differential input (such as the ADC12DJ5200-SP or AFE7950-SP). Conventionally passive baluns are used to drive giga-samples-per-second (GSPS) ADCs as a result of the low availability of high-bandwidth, linear amplifiers. The TRF0208-SP is typically configured as a single-ended to differential (S2D) RF amplifier that has excellent bandwidth flatness, gain, and phase imbalance comparable to or exceeding costly passive RF baluns.

Figure 7-1 shows a typical interface circuit for ADC12DJ5200-SP. Depending on the ADC and system requirement, this circuit can be simplified or can be more complex.

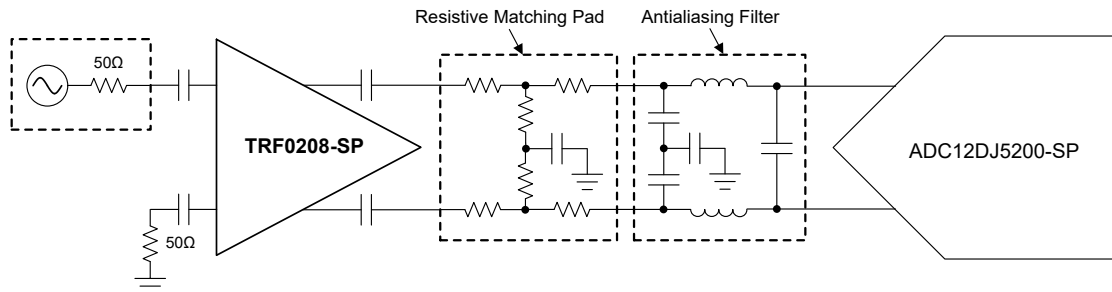
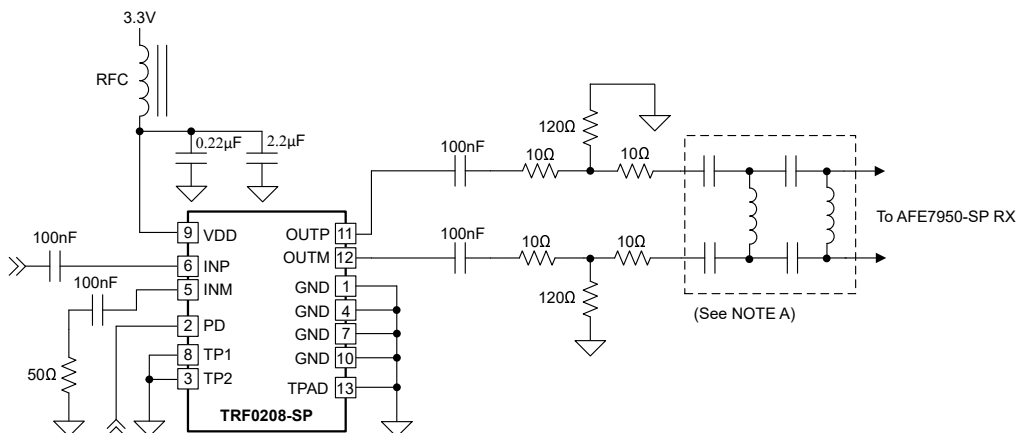

Figure 7-1. Interfacing With the ADC12DJ5200-SP

Figure 7-1 shows two sections of the circuit between the driver amp and the ADC: namely, the matching pad (or attenuator pad) and the antialiasing filter. Use small-form-factor, RF-quality, passive components for these circuits. The output swing of the TRF0208-SP is designed to drive these ADCs full-scale, while at the same time not overdrive the ADC. This functionality avoids the need for any voltage limiting device at the ADC.

Figure 7-2 shows a typical interface circuit for the AFE7950-SP, where the TRF0208-SP is the S2D amplifier.



A. AFE matching network – component type (L or C) and values depend on channel (A, B, C, D, FB1, and FB2) and frequency band.

Figure 7-2. Interfacing With the AFE7950-SP

7.1.2 Calculating Output Voltage Swing

This section gives a quick reference of the output voltage swings for different input power levels. In this example, the output is terminated with a 100Ω differential load and a power gain of 16dB is assumed.

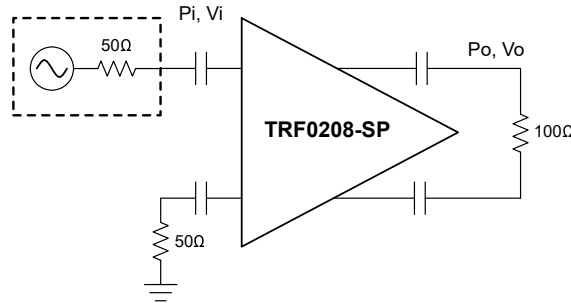

Figure 7-3. Power and Voltage Levels

$$\text{Voltage gain} = 20 \times \log(V_O / V_I) \tag{1}$$

$$\text{Power gain} = 10 \times \log(P_O / P_I) = 10 \times \log((V_O^2 / 100) / (V_I^2 / 50)) = 20 \times \log(V_O / V_I) - 3\text{dB} \tag{2}$$

Table 7-1. Output Voltage Swings for Different Input Power Levels

INPUT		OUTPUT (TRF0208-SP)	
P _I (dBm ₅₀)	V _I (V _{PP})	P _O (dBm ₁₀₀)	V _O (V _{PP})
-20	0.063	-4	0.564
-15	0.112	1	1.004
-10	0.2	6	1.785
-9	0.224	7	2.002

7.1.3 Thermal Considerations

The TRF0208-SP is available in a 2mm × 2mm, WQFN-FCRLF package that has excellent thermal properties. Connect the thermal pad underneath the chip to a ground plane. Short the ground plane to the other ground pins of the chip at four corners, if possible, to allow heat propagation to the top layer of PCB. Use a thermal via that connects the thermal pad plane on the top layer of the PCB to the inner layer ground planes to allow heat propagation to the inner layers.

7.2 Typical Applications

An example of the TRF0208-SP acting as an S2D amplifier for the AFE7950-SP is explained in this section.

7.2.1 TRF0208-SP in Receive Chain

This section describes an RF receiver chain in which the TRF0208-SP operates as a single-ended-to-differential (S2D) amplifier and drives a receive channel of AFE7950-SP.

Figure 7-4 shows a generic schematic of a design in which TRF0208-SP drives an AFE7950-SP receive channel. The exact values of the components depend on the frequency band for which the AFE7950-SP front-end is matched.

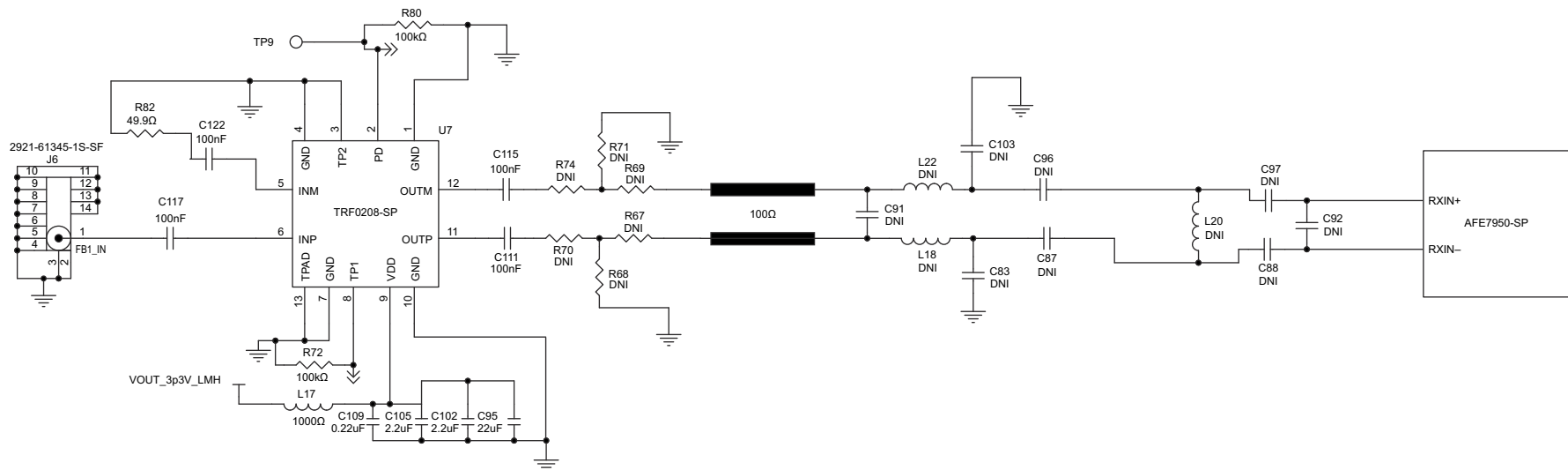

Figure 7-4. TRF0208-SP in a Receive Chain With the AFE7950-SP

7.2.1.1 Design Requirements

The AFE7950-SP channel is required to be matched to 2.3GHz.

7.2.1.2 Detailed Design Procedure

The TRF0208-SP is configured as an S2D amplifier. The section close to TRF0208-SP output is an attenuator pad that is meant for robust matching. The section close to the AFE7950-SP is the matching network for the AFE7950-SP ADC input that is channel dependent. The matching components are chosen based on the AFE7950-SP return-loss data and some final optimization because the manufactured board parameters can influence the exact component values needed.

Table 7-2 shows the bill of materials (BOM) values of the design for RXA channel that is matched to center frequency of 2.3GHz.

Table 7-2. Component Values of RX Chain With Center Frequency = 2.3GHz

SECTION	DESIGNATOR	TYPE	VALUE	INSTALL OR DO NOT INSTALL
DC block cap	C117	Capacitor	100nF	Install
DC block cap	C115	Capacitor	100nF	Install
DC block cap	C111	Capacitor	100nF	Install
DC block cap	C122	Capacitor	100nF	Install
INM term	R82	Resistor	50Ω	Install
Attenuator	R74	Resistor	10Ω	Install
Attenuator	R70	Resistor	10Ω	Install
Attenuator	R69	Resistor	10Ω	Install
Attenuator	R67	Resistor	10Ω	Install
Attenuator	R71	Resistor	120Ω	Install
Attenuator	R68	Resistor	120Ω	Install
Matching	C91	—	—	Do not install
Matching	C103	—	—	Do not install
Matching	C83	—	—	Do not install
Matching	L22	Inductor	0.1nH	Install
Matching	L18	Inductor	0.1nH	Install
Matching	C96	Inductor	0.1nH	Install
Matching	C87	Inductor	0.1nH	Install
Matching	L20	Inductor	5.6nH	Install
Matching	C97	Capacitor	3.9pF	Install
Matching	C88	Capacitor	3.9pF	Install
Matching	C92	—	—	Do not install

7.2.1.3 Application Curve

Figure 7-5 shows the in-band output response for the design in the previous section. The response is measured with an input power of -30dBm at the input of TRF0208-SP.

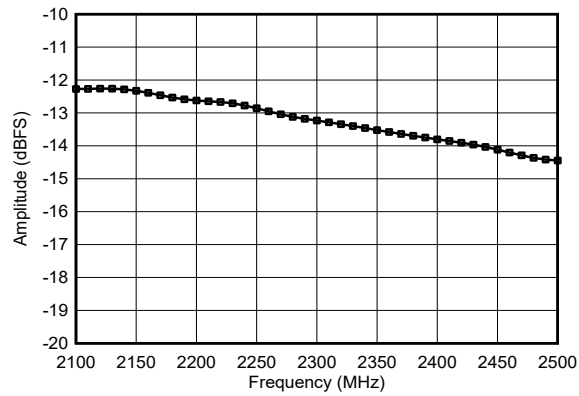

Figure 7-5. In-Band Output Response

7.3 Power Supply Recommendations

The TRF0208-SP requires a single 3.3V supply. Supply decoupling is critical to high-frequency performance. Typically two or three capacitors are used for supply decoupling. For the lowest-value capacitor, use a small, form-factor component that is placed closest to the V_{DD} pin of the device. Use a bulk decoupling capacitor of a larger value and size that can be placed next to the small capacitor. See also [Section 7.4](#).

7.4 Layout

7.4.1 Layout Guidelines

TRF0208-SP is a wide-band, voltage-feedback amplifier with approximately 16dB of gain. When designing with a wide-band RF amplifier with relatively high gain, take precautions with board layout to maintain stability and optimized performance. Use a multilayer board to maintain signal and power integrity and thermal performance. [Figure 7-6](#) shows an example of a good layout. This figure shows only the top layer.

Route the RF input and output lines as grounded coplanar waveguide (GCPW) lines. For the second layer, use a continuous ground layer without any ground-cuts near the amplifier area. Match the output differential lines in length to minimize phase imbalance. Use small-footprint passive components wherever possible. Also take care of the input side layout. Use a 50Ω line for the INP routing, and ensure that the termination on INM pin has low parasitics by placing the ac-coupling capacitor and the 50Ω resistor very close to the device. Use an RF-quality, 50Ω resistor for termination. Ensure that the ground planes on the top and internal layers are well stitched with vias.

Place thermal vias under the device that connect the top thermal pad with ground planes in the inner layers of the PCB. For improved heat dissipation, connect the thermal pad to the top-layer ground plane through the ground pins (see also [Section 7.4.2](#)).

7.4.2 Layout Example

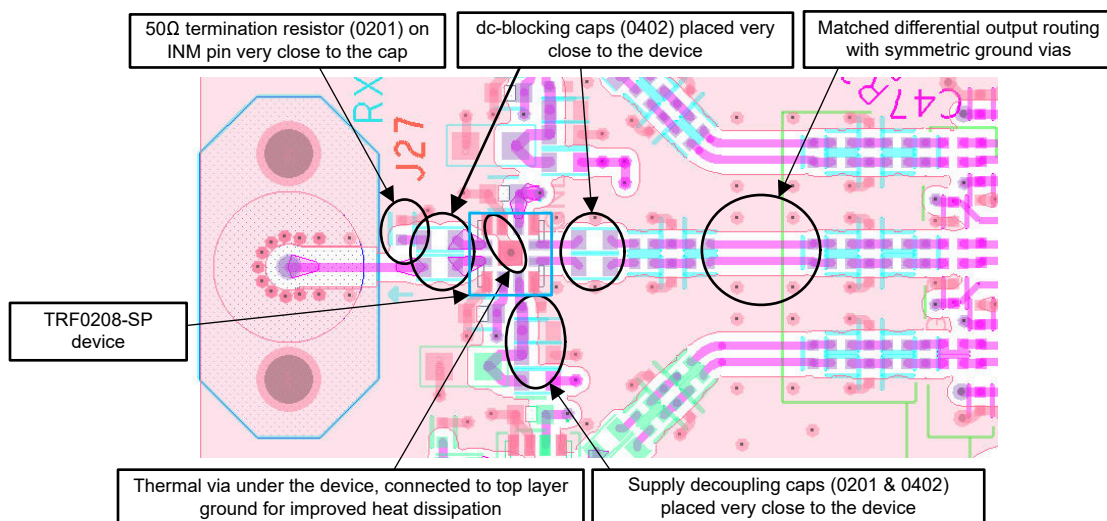

Figure 7-6. Layout Example – Placement and Top Layer Layout

The TRF0208-SP device can be evaluated using the TRF0208-SP EVM board. Additional information about the evaluation board construction and test setup is given in the [TRF0208SEP/SP EVM user's guide](#).

8 Device and Documentation Support

8.1 Device Support

8.1.1 Third-Party Products Disclaimer

TI'S PUBLICATION OF INFORMATION REGARDING THIRD-PARTY PRODUCTS OR SERVICES DOES NOT CONSTITUTE AN ENDORSEMENT REGARDING THE SUITABILITY OF SUCH PRODUCTS OR SERVICES OR A WARRANTY, REPRESENTATION OR ENDORSEMENT OF SUCH PRODUCTS OR SERVICES, EITHER ALONE OR IN COMBINATION WITH ANY TI PRODUCT OR SERVICE.

8.2 Documentation Support

8.2.1 Related Documentation

For related documentation, see the following:

- Texas Instruments, [TRF0208SEP/SP EVM user's guide](#)

8.3 Receiving Notification of Documentation Updates

To receive notification of documentation updates, navigate to the device product folder on [ti.com](#). Click on *Notifications* to register and receive a weekly digest of any product information that has changed. For change details, review the revision history included in any revised document.

8.4 Support Resources

[TI E2E™ support forums](#) are an engineer's go-to source for fast, verified answers and design help — straight from the experts. Search existing answers or ask your own question to get the quick design help you need.

Linked content is provided "AS IS" by the respective contributors. They do not constitute TI specifications and do not necessarily reflect TI's views; see TI's [Terms of Use](#).

8.5 Trademarks

TI E2E™ is a trademark of Texas Instruments.

All trademarks are the property of their respective owners.

8.6 Electrostatic Discharge Caution



This integrated circuit can be damaged by ESD. Texas Instruments recommends that all integrated circuits be handled with appropriate precautions. Failure to observe proper handling and installation procedures can cause damage.

ESD damage can range from subtle performance degradation to complete device failure. Precision integrated circuits may be more susceptible to damage because very small parametric changes could cause the device not to meet its published specifications.

8.7 Glossary

[TI Glossary](#) This glossary lists and explains terms, acronyms, and definitions.

9 Revision History

NOTE: Page numbers for previous revisions may differ from page numbers in the current version.

Changes from Revision * (June 2024) to Revision A (December 2024)	Page
• Changed TRF0208RPVTSP/EM status from advanced information to production data (active).....	1

10 Mechanical, Packaging, and Orderable Information

The following pages include mechanical, packaging, and orderable information. This information is the most current data available for the designated devices. This data is subject to change without notice and revision of this document. For browser-based versions of this data sheet, refer to the left-hand navigation.

PACKAGING INFORMATION

Orderable Device	Status (1)	Package Type	Package Drawing	Pins	Package Qty	Eco Plan (2)	Lead finish/ Ball material (6)	MSL Peak Temp (3)	Op Temp (°C)	Device Marking (4/5)	Samples
TRF0208RPVTSP/EM	ACTIVE	WQFN-HR	RPV	12	250	RoHS & Green	NIPDAU	Level-2-260C-1 YEAR	25 to 25	202	Samples

(1) The marketing status values are defined as follows:

ACTIVE: Product device recommended for new designs.

LIFEBUY: TI has announced that the device will be discontinued, and a lifetime-buy period is in effect.

NRND: Not recommended for new designs. Device is in production to support existing customers, but TI does not recommend using this part in a new design.

PREVIEW: Device has been announced but is not in production. Samples may or may not be available.

OBSELETE: TI has discontinued the production of the device.

(2) **RoHS:** TI defines "RoHS" to mean semiconductor products that are compliant with the current EU RoHS requirements for all 10 RoHS substances, including the requirement that RoHS substance do not exceed 0.1% by weight in homogeneous materials. Where designed to be soldered at high temperatures, "RoHS" products are suitable for use in specified lead-free processes. TI may reference these types of products as "Pb-Free".

RoHS Exempt: TI defines "RoHS Exempt" to mean products that contain lead but are compliant with EU RoHS pursuant to a specific EU RoHS exemption.

Green: TI defines "Green" to mean the content of Chlorine (Cl) and Bromine (Br) based flame retardants meet JS709B low halogen requirements of <=1000ppm threshold. Antimony trioxide based flame retardants must also meet the <=1000ppm threshold requirement.

(3) MSL, Peak Temp. - The Moisture Sensitivity Level rating according to the JEDEC industry standard classifications, and peak solder temperature.

(4) There may be additional marking, which relates to the logo, the lot trace code information, or the environmental category on the device.

(5) Multiple Device Markings will be inside parentheses. Only one Device Marking contained in parentheses and separated by a "-" will appear on a device. If a line is indented then it is a continuation of the previous line and the two combined represent the entire Device Marking for that device.

(6) Lead finish/Ball material - Orderable Devices may have multiple material finish options. Finish options are separated by a vertical ruled line. Lead finish/Ball material values may wrap to two lines if the finish value exceeds the maximum column width.

Important Information and Disclaimer:The information provided on this page represents TI's knowledge and belief as of the date that it is provided. TI bases its knowledge and belief on information provided by third parties, and makes no representation or warranty as to the accuracy of such information. Efforts are underway to better integrate information from third parties. TI has taken and continues to take reasonable steps to provide representative and accurate information but may not have conducted destructive testing or chemical analysis on incoming materials and chemicals. TI and TI suppliers consider certain information to be proprietary, and thus CAS numbers and other limited information may not be available for release.

In no event shall TI's liability arising out of such information exceed the total purchase price of the TI part(s) at issue in this document sold by TI to Customer on an annual basis.

TAPE AND REEL INFORMATION

QUADRANT ASSIGNMENTS FOR PIN 1 ORIENTATION IN TAPE



*All dimensions are nominal

Device	Package Type	Package Drawing	Pins	SPQ	Reel Diameter (mm)	Reel Width W1 (mm)	A0 (mm)	B0 (mm)	K0 (mm)	P1 (mm)	W (mm)	Pin1 Quadrant
TRF0208RPVTSP/EM	WQFN-HR	RPV	12	250	180.0	8.4	2.3	2.3	1.15	4.0	8.0	Q2

TAPE AND REEL BOX DIMENSIONS

*All dimensions are nominal

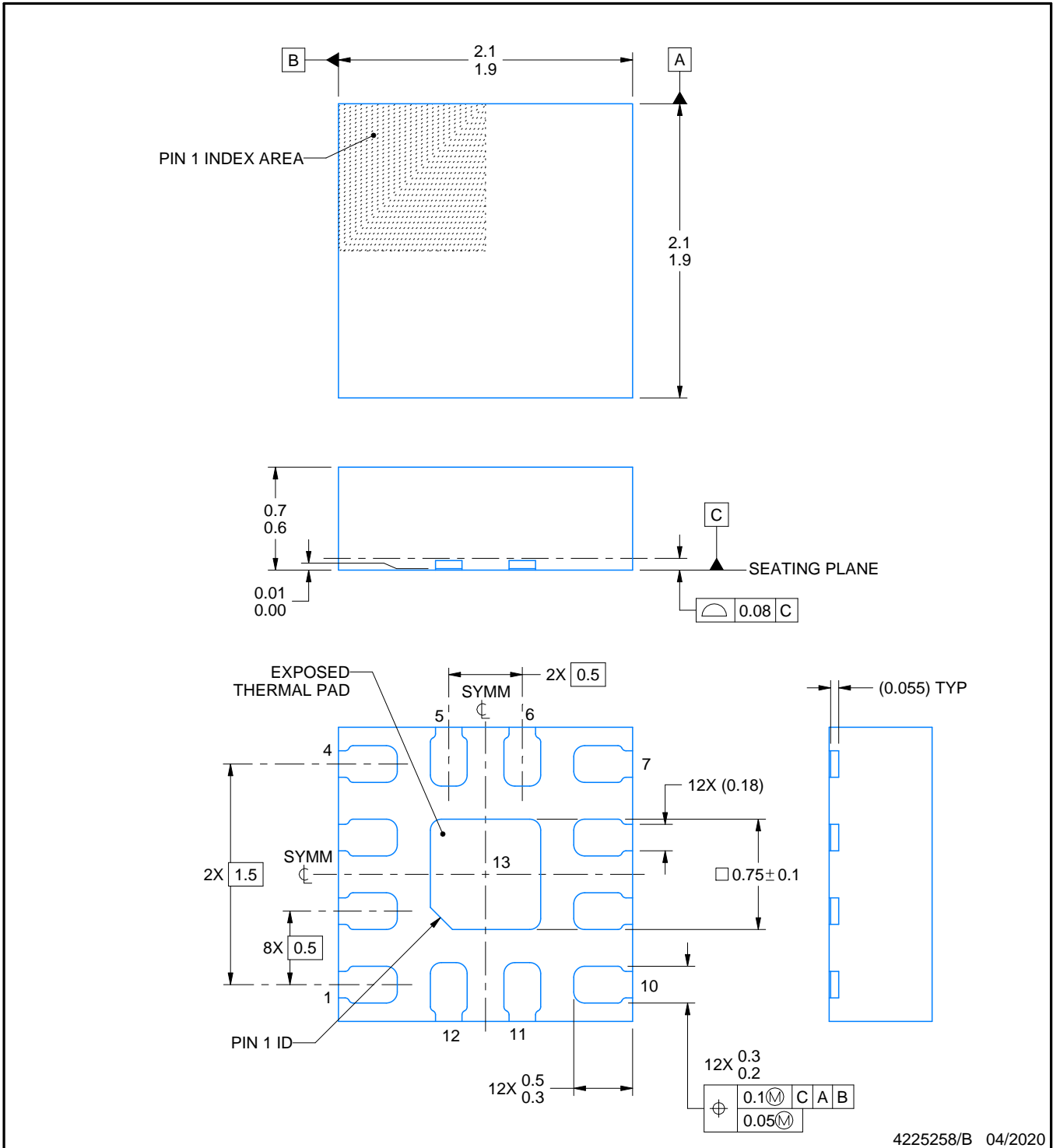
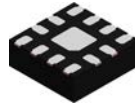
Device	Package Type	Package Drawing	Pins	SPQ	Length (mm)	Width (mm)	Height (mm)
TRF0208RPVTSP/EM	WQFN-HR	RPV	12	250	210.0	185.0	35.0



4225258/B 04/2020

NOTES:

1. All linear dimensions are in millimeters. Any dimensions in parenthesis are for reference only. Dimensioning and tolerancing per ASME Y14.5M.
2. This drawing is subject to change without notice.
3. The package thermal pad must be soldered to the printed circuit board for thermal and mechanical performance.

EXAMPLE BOARD LAYOUT

RPV0012A

WQFN-FCRLF - 0.7 mm max height

PLASTIC QUAD FLATPACK - NO LEAD

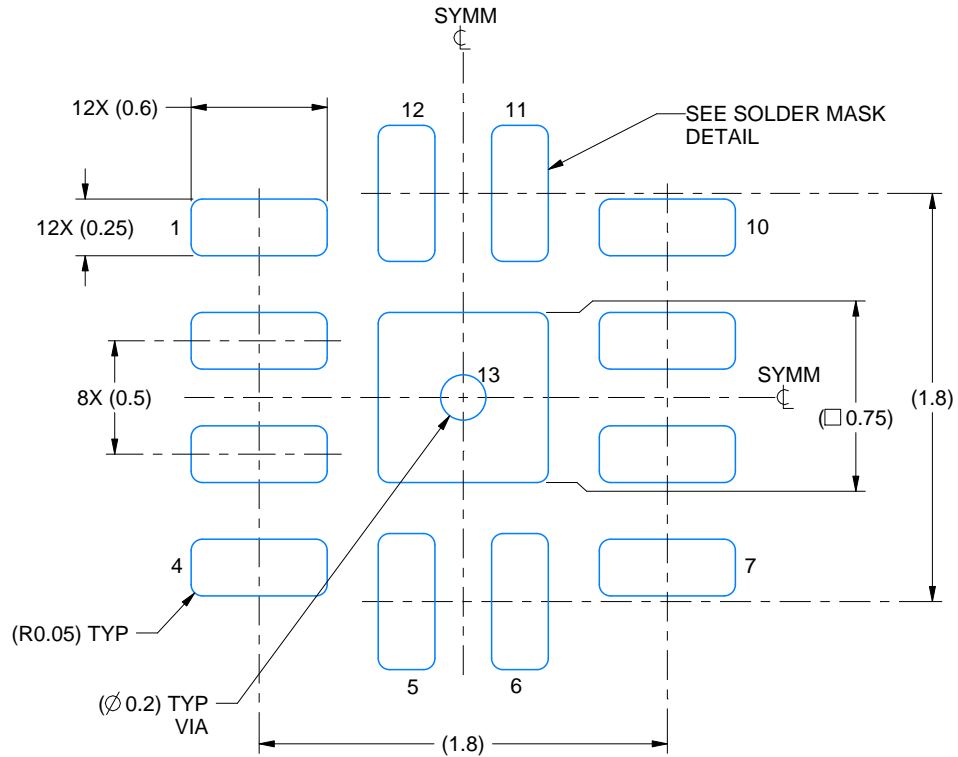

LAND PATTERN EXAMPLE
EXPOSED METAL SHOWN
SCALE: 30X



SOLDER MASK DETAILS

4225258/B 04/2020

NOTES: (continued)

- This package is designed to be soldered to a thermal pad on the board. For more information, see Texas Instruments literature number SLUA271 (www.ti.com/lit/sluea271).
- Vias are optional depending on application, refer to device data sheet. If any vias are implemented, refer to their locations shown on this view. It is recommended that vias under paste be filled, plugged or tented.

EXAMPLE STENCIL DESIGN

RPV0012A

WQFN-FCRLF - 0.7 mm max height

PLASTIC QUAD FLATPACK - NO LEAD

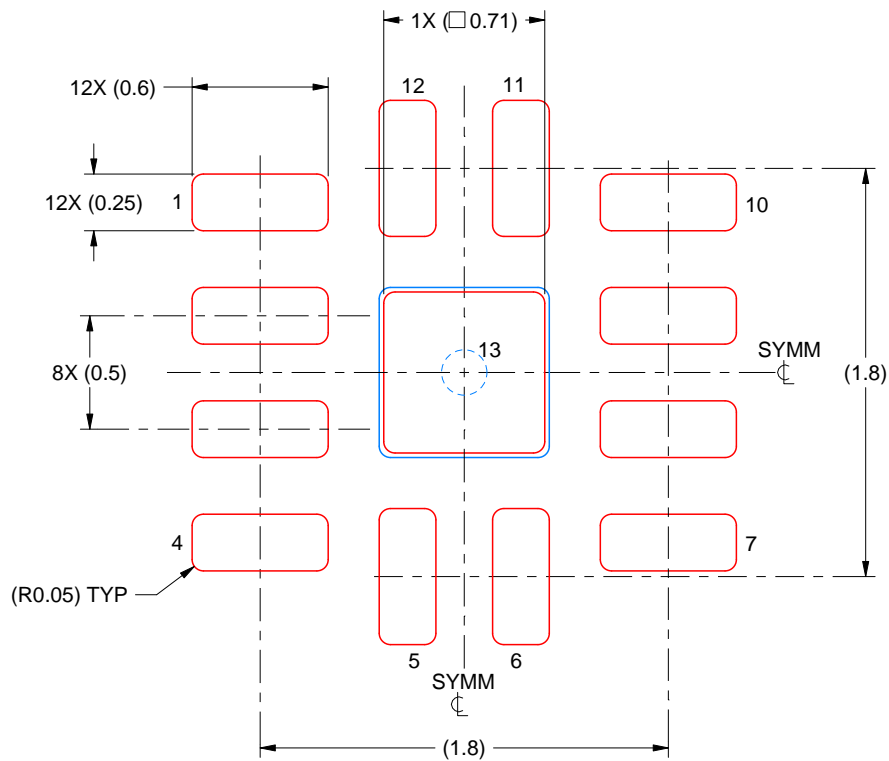

SOLDER PASTE EXAMPLE
BASED ON 0.125 MM THICK STENCIL
SCALE: 30X

EXPOSED PAD 13
90% PRINTED SOLDER COVERAGE BY AREA UNDER PACKAGE

4225258/B 04/2020

NOTES: (continued)

6. Laser cutting apertures with trapezoidal walls and rounded corners may offer better paste release. IPC-7525 may have alternate design recommendations.

IMPORTANT NOTICE AND DISCLAIMER

TI PROVIDES TECHNICAL AND RELIABILITY DATA (INCLUDING DATA SHEETS), DESIGN RESOURCES (INCLUDING REFERENCE DESIGNS), APPLICATION OR OTHER DESIGN ADVICE, WEB TOOLS, SAFETY INFORMATION, AND OTHER RESOURCES "AS IS" AND WITH ALL FAULTS, AND DISCLAIMS ALL WARRANTIES, EXPRESS AND IMPLIED, INCLUDING WITHOUT LIMITATION ANY IMPLIED WARRANTIES OF MERCHANTABILITY, FITNESS FOR A PARTICULAR PURPOSE OR NON-INFRINGEMENT OF THIRD PARTY INTELLECTUAL PROPERTY RIGHTS.

These resources are intended for skilled developers designing with TI products. You are solely responsible for (1) selecting the appropriate TI products for your application, (2) designing, validating and testing your application, and (3) ensuring your application meets applicable standards, and any other safety, security, regulatory or other requirements.

These resources are subject to change without notice. TI grants you permission to use these resources only for development of an application that uses the TI products described in the resource. Other reproduction and display of these resources is prohibited. No license is granted to any other TI intellectual property right or to any third party intellectual property right. TI disclaims responsibility for, and you will fully indemnify TI and its representatives against, any claims, damages, costs, losses, and liabilities arising out of your use of these resources.

TI's products are provided subject to [TI's Terms of Sale](#) or other applicable terms available either on [ti.com](https://www.ti.com) or provided in conjunction with such TI products. TI's provision of these resources does not expand or otherwise alter TI's applicable warranties or warranty disclaimers for TI products.

TI objects to and rejects any additional or different terms you may have proposed.

Mailing Address: Texas Instruments, Post Office Box 655303, Dallas, Texas 75265
Copyright © 2024, Texas Instruments Incorporated