

# TPS7B81-Q1 150mA、オフ・バッテリー、超低 $I_Q$ (3 $\mu$ A)、低ドロップアウト・レギュレータ

## 1 特長

- 車載アプリケーション用に AEC-Q100 認定取得済み
  - 温度グレード 1: -40°C~125°C,  $T_A$
- デバイス接合部温度範囲: -40°C~150°C
- 3V~40V の広い  $V_{IN}$  入力電圧範囲、最大 45V の過渡電圧に対応
- 最大出力電流: 150mA
- 低い静止電流  $I_Q$ 
  - EN = LOW (シャットダウン・モード) 時: 300nA (標準値)
  - 軽負荷時: 2.7 $\mu$ A (標準値)
  - 軽負荷時: 4.5 $\mu$ A (最大値)
- ライン、負荷、温度の全範囲にわたって 1.5% の出力電圧精度
- 最大ドロップアウト電圧: 固定 5V 出力バージョンで、負荷電流 150mA 時に 540mV
- 低 ESR (0.001 $\Omega$ ~5 $\Omega$ ) のセラミック出力コンデンサ (1 $\mu$ F~200 $\mu$ F) で安定
- 5V、3.3V、2.5V の固定出力電圧
- フォルト保護機能を搭載
  - サーマル・シャットダウン
  - 短絡保護と過電流保護
- パッケージ
  - DGN (8 ピン HVSSOP)、 $R_{\theta JA} = 63.9^\circ\text{C}/\text{W}$
  - DRV (6 ピン WSON)、 $R_{\theta JA} = 72.8^\circ\text{C}/\text{W}$
  - KVU (5 ピン TO-252)、 $R_{\theta JA} = 38.8^\circ\text{C}/\text{W}$

## 2 アプリケーション

- 車載用ヘッド・ユニット
- ヘッドライト
- バッテリー管理システム (BMS)
- インバータおよびモータ制御

## 3 概要

車載用のバッテリー接続アプリケーションでは、電力を節約し、バッテリー駆動時間を延長するため、静止電流 ( $I_Q$ ) が低いことが重要です。常時オンのシステムでは、車両のエンジンが停止しているときも継続して動作できるようにするため、より広い温度範囲にわたって非常に低い  $I_Q$  が要求されます。

TPS7B81-Q1 は、 $V_{IN}$  が 40V までのアプリケーション用に設計された低ドロップアウト・リニア・レギュレータです。このデバイスは、軽負荷時の静止電流がわずか 2.7 $\mu$ A (標準値) であるため、スタンバイ・システム内のマイクロコントローラや CAN/LIN (コントローラ・エリア・ネットワーク/ローカル相互接続ネットワーク) トランシーバへの給電に最適のソリューションです。

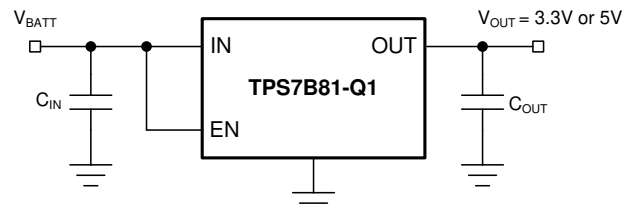
このデバイスには、短絡および過電流保護機能が内蔵されています。このデバイスは -40°C~+125°C の周囲温度と、-40°C~+150°C の接合部温度で動作します。また、このデバイスは、それぞれサイズと熱伝導率が異なる複数のパッケージで供給されます。小さな WSON パッケージを使用すると最も小型の PCB を容易に設計でき、TO-252 パッケージを使用するとデバイスの熱損失が大きくても連続動作が可能です。これらの特長により、このデバイスは各種のバッテリー接続車載アプリケーションの電源として適しています。

### 製品情報<sup>(1)</sup>

型番	パッケージ	本体サイズ (公称)
TPS7B81-Q1	HVSSOP (8)	3.00mm×3.00mm
	WSON (6)	2.00mm×2.00mm
	TO-252 (5)	6.10mm×6.60mm

(1) 利用可能なすべてのパッケージについては、このデータシートの末尾にある注文情報を参照してください。

### 代表的なアプリケーションの回路図



## 目次

1	特長	1	7.4	Device Functional Modes	12
2	アプリケーション	1	8	<b>Application and Implementation</b>	13
3	概要	1	8.1	Application Information	13
4	改訂履歴	2	8.2	Typical Application	17
5	<b>Pin Configuration and Functions</b>	3	9	<b>Power Supply Recommendations</b>	18
6	<b>Specifications</b>	5	10	<b>Layout</b>	19
6.1	Absolute Maximum Ratings	5	10.1	Layout Guidelines	19
6.2	ESD Ratings	5	10.2	Layout Example	19
6.3	Recommended Operating Conditions	5	11	デバイスおよびドキュメントのサポート	20
6.4	Thermal Information	5	11.1	ドキュメントの更新通知を受け取る方法	20
6.5	Electrical Characteristics	6	11.2	サポート・リソース	20
6.6	Typical Characteristics	7	11.3	商標	20
7	<b>Detailed Description</b>	11	11.4	静電気放電に関する注意事項	20
7.1	Overview	11	11.5	Glossary	20
7.2	Functional Block Diagram	11	12	メカニカル、パッケージ、および注文情報	20
7.3	Feature Description	11			

## 4 改訂履歴

資料番号末尾の英字は改訂を表しています。その改訂履歴は英語版に準じています。

### Revision B (August 2019) から Revision C に変更 Page

•	KVU パッケージをプレビューから量産データに 変更	1
•	「アプリケーション」セクションを 変更	1

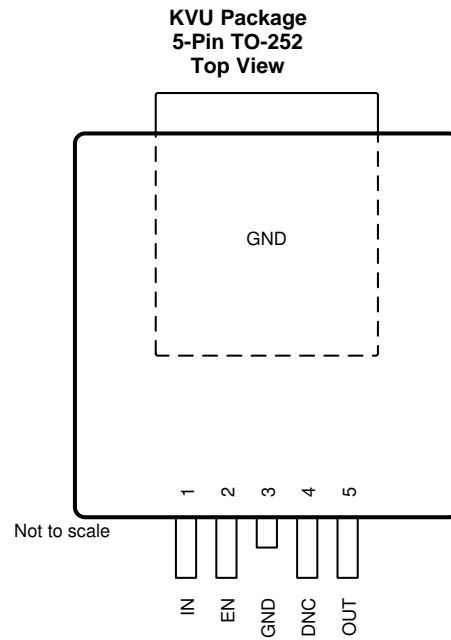
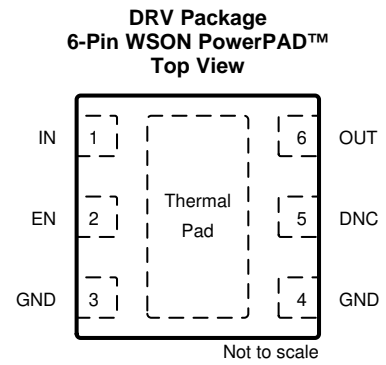
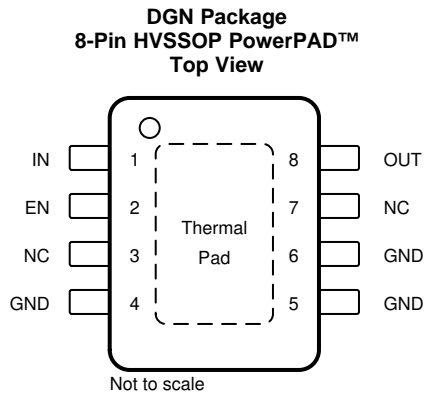
### Revision A (June 2019) から Revision B に変更 Page

•	DGN パッケージをプレビューから量産データに 変更	1
•	「特長」の最大ドロップアウト電圧の項目で 525mV を 540mV に 変更	1
•	追加 $R_{\theta JA}$ versus Cu Area for the HVSSOP (DGN) Package through $\psi_{JB}$ versus Cu Area for the TO-252 (KVU) Package figures to Power Dissipation section	15
•	Deleted values from capacitors $C_{IN}$ and $C_{OUT}$ in <a href="#">図 31</a>	17

### 2019年5月発行のものから更新 Page

•	事前情報を量産データに 変更	1
---	----------------	---

## 5 Pin Configuration and Functions



**Pin Functions**

NAME	PIN			I/O	DESCRIPTION
	NO.				
	DGN	DRV	KVU		
DNC	—	5	4	—	Do not connect to a biased voltage. Tie this pin to ground or leave floating.
EN	2	2	2	I	Enable input pin. Drive EN greater than $V_{IH}$ to turn on the regulator. Drive EN less than $V_{IL}$ to put the low-dropout (LDO) into shutdown mode.
GND	4, 5, 6	3,4	3, TAB	—	Ground reference
IN	1	1	1	I	Input power-supply pin. For best transient response and to minimize input impedance, use the recommended value or larger ceramic capacitor from IN to ground as listed in the <a href="#">Recommended Operating Conditions</a> table and the <a href="#">Input Capacitor</a> section. Place the input capacitor as close to the output of the device as possible.
NC	3, 7	—	—	—	Not internally connected
OUT	8	6	5	O	Regulated output voltage pin. A capacitor is required from OUT to ground for stability. For best transient response, use the nominal recommended value or larger ceramic capacitor from OUT to ground; see the <a href="#">Recommended Operating Conditions</a> table and the <a href="#">Output Capacitor</a> section. Place the output capacitor as close to output of the device as possible.
Thermal pad				—	Connect the thermal pad to a large-area GND plane for improved thermal performance.

## 6 Specifications

### 6.1 Absolute Maximum Ratings

over operating ambient temperature range (unless otherwise noted)<sup>(1)(2)</sup>

		MIN	MAX	UNIT
V <sub>IN</sub>	Unregulated input <sup>(3)</sup>	-0.3	45	V
V <sub>EN</sub>	Enable input <sup>(3)</sup>	-0.3	V <sub>IN</sub>	V
V <sub>OUT</sub>	Regulated output	-0.3	7	V
T <sub>J</sub>	Junction temperature range	-40	150	°C
T <sub>stg</sub>	Storage temperature range	-40	150	°C

- (1) Stresses beyond those listed under *Absolute Maximum Ratings* may cause permanent damage to the device. These are stress ratings only, which do not imply functional operation of the device at these or any other conditions beyond those indicated under *Recommended Operating Conditions*. Exposure to absolute-maximum-rated conditions for extended periods may affect device reliability.
- (2) All voltage values are with respect to GND.
- (3) Absolute maximum voltage, can withstand 45 V for 200 ms.

### 6.2 ESD Ratings

			VALUE	UNIT	
V <sub>(ESD)</sub>	Electrostatic discharge	Human-body model (HBM), per AEC Q100-002 <sup>(1)</sup>	±2000	V	
		Charged-device model (CDM), per AEC Q100-011	Corner pins		±750
			Other pins		±500

- (1) AEC Q100-002 indicates that HBM stressing shall be in accordance with the ANSI/ESDA/JEDEC JS-001 specification.

### 6.3 Recommended Operating Conditions

over operating ambient temperature range (unless otherwise noted)

		MIN	MAX	UNIT
V <sub>IN</sub>	Unregulated input voltage	3	40	V
V <sub>EN</sub>	Enable input voltage	0	V <sub>IN</sub>	V
C <sub>OUT</sub>	Output capacitor requirements <sup>(1)</sup>	1	200	μF
ESR	Output capacitor ESR requirements <sup>(2)</sup>	0.001	5	Ω
T <sub>A</sub>	Ambient temperature range	-40	125	°C
T <sub>J</sub>	Junction temperature range	-40	150	°C

- (1) The output capacitance range specified in the table is the effective value.
- (2) Relevant ESR value at f = 10 kHz

### 6.4 Thermal Information

THERMAL METRIC <sup>(1)</sup>		TPS7B81-Q1			UNIT
		DGN (HVSSOP)	DRV (WSON)	KVU (TO-252)	
		8 PINS	6 PINS	5 PINS	
R <sub>θJA</sub>	Junction-to-ambient thermal resistance	63.9	72.8	31.1	°C/W
R <sub>θJC(top)</sub>	Junction-to-case (top) thermal resistance	50.2	85.8	39.9	°C/W
R <sub>θJB</sub>	Junction-to-board thermal resistance	22.6	37.4	9.9	°C/W
ψ <sub>JT</sub>	Junction-to-top characterization parameter	1.8	2.7	4.2	°C/W
ψ <sub>JB</sub>	Junction-to-board characterization parameter	22.3	37.3	9.9	°C/W
R <sub>θJC(bot)</sub>	Junction-to-case (bottom) thermal resistance	12.1	13.8	2.8	°C/W

- (1) For more information about traditional and new thermal metrics, see the [Semiconductor and IC Package Thermal Metrics application report](#).

## 6.5 Electrical Characteristics

over operating ambient temperature range,  $T_J = -40^{\circ}\text{C}$  to  $+150^{\circ}\text{C}$ ,  $V_{IN} = 14\text{ V}$ , and  $10\text{-}\mu\text{F}$  ceramic output capacitor (unless otherwise noted)

PARAMETER		TEST CONDITIONS		MIN	TYP	MAX	UNIT
<b>SUPPLY VOLTAGE AND CURRENT (IN)</b>							
$V_{IN}$	Input voltage			$V_{OUT(Nom)} + V_{(Dropout)}$		40	V
$I_{(SD)}$	Shutdown current	$EN = 0\text{ V}$		0.3		1	$\mu\text{A}$
$I_{(Q)}$	Quiescent current	$V_{IN} = 6\text{ V to }40\text{ V}, EN \geq 2\text{ V}, I_{OUT} = 0\text{ mA}$		1.9		3.5	$\mu\text{A}$
		$V_{IN} = 6\text{ V to }40\text{ V}, EN \geq 2\text{ V}, I_{OUT} = 0.2\text{ mA}$	DGN package	2.7		6.5	
			DRV and KVU packages	2.7		4.5	
$V_{(IN, UVLO)}$	$V_{IN}$ undervoltage detection	Ramp $V_{IN}$ down until the output turns off				2.7	V
		Hysteresis				200	mV
<b>ENABLE INPUT (EN)</b>							
$V_{IL}$	Logic-input low level					0.7	V
$V_{IH}$	Logic-input high level			2			V
$I_{EN}$	Enable current				10		nA
<b>REGULATED OUTPUT (OUT)</b>							
$V_{OUT}$	Regulated output	$V_{IN} = V_{OUT} + V_{(Dropout)}$ to $40\text{ V}, I_{OUT} = 1\text{ mA to }150\text{ mA}$		-1.5%		1.5%	
$V_{(Line-Reg)}$	Line regulation	$V_{IN} = 6\text{ V to }40\text{ V}, I_{OUT} = 10\text{ mA}$				10	mV
$V_{(Load-Reg)}$	Load regulation	$V_{IN} = 14\text{ V}, I_{OUT} = 1\text{ mA to }150\text{ mA}$		DGN package		20	mV
				DRV and KVU packages		10	
$V_{(Dropout)}$	Dropout voltage	$V_{OUT} = 5\text{ V}$	$I_{OUT} = 150\text{ mA}$	DGN package	270	540	mV
				DRV and KVU packages	325	585	
		$I_{OUT} = 100\text{ mA}$	DGN package	180	350		
			DRV and KVU packages	200	390		
		$V_{OUT} = 3.3\text{ V}$	$I_{OUT} = 150\text{ mA}$	DGN package		650	
				DRV and KVU packages	345	675	
$I_{OUT} = 100\text{ mA}$	$V_{OUT} = 2.5\text{ V}, \text{DGN package}$			750			
				500			
$I_{OUT}$	Output current	$V_{OUT}$ in regulation, $V_{IN} = 7\text{ V}$ for the fixed 5-V option, $V_{IN} = 5.8\text{ V}$ for the fixed 3.3-V option		0		150	mA
$I_{(CL)}$	Output current limit	$V_{OUT}$ short to $90\% \times V_{OUT}$		180	510	690	mA
PSRR	Power-supply ripple rejection	$V_{(Ripple)} = 0.5\text{ V}_{PP}, I_{OUT} = 10\text{ mA}, \text{frequency} = 100\text{ Hz}, C_{OUT} = 2.2\text{ }\mu\text{F}$			60		dB
<b>OPERATING TEMPERATURE RANGE</b>							
$T_{(SD)}$	Junction shutdown temperature				175		$^{\circ}\text{C}$
$T_{(HYST)}$	Hysteresis of thermal shutdown				20		$^{\circ}\text{C}$

## 6.6 Typical Characteristics

at  $T_J = -40^\circ\text{C}$  to  $+150^\circ\text{C}$ ,  $V_{IN} = 14\text{ V}$ , and  $V_{EN} \geq 2\text{ V}$  (unless otherwise noted)

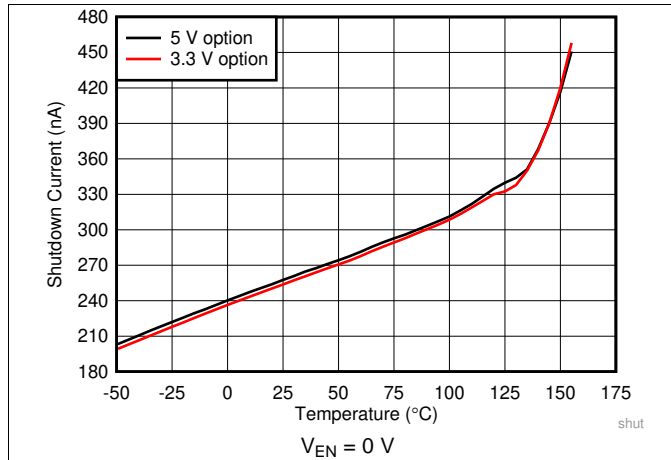


Fig 1. Shutdown Current vs Ambient Temperature

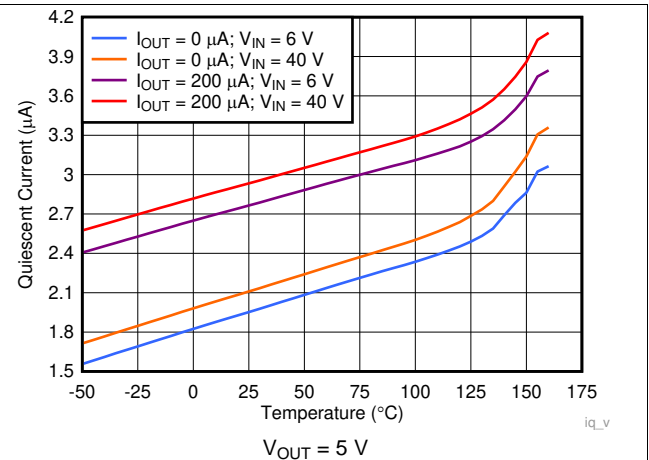


Fig 2. Quiescent Current vs Ambient Temperature

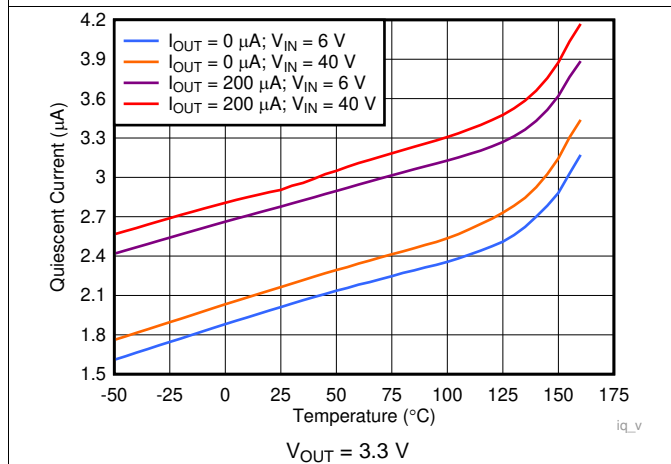


Fig 3. Quiescent Current vs Ambient Temperature

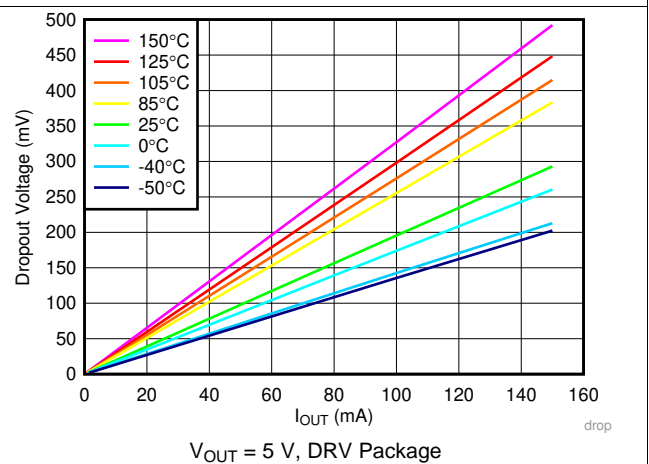


Fig 4. Dropout Voltage vs Output Current

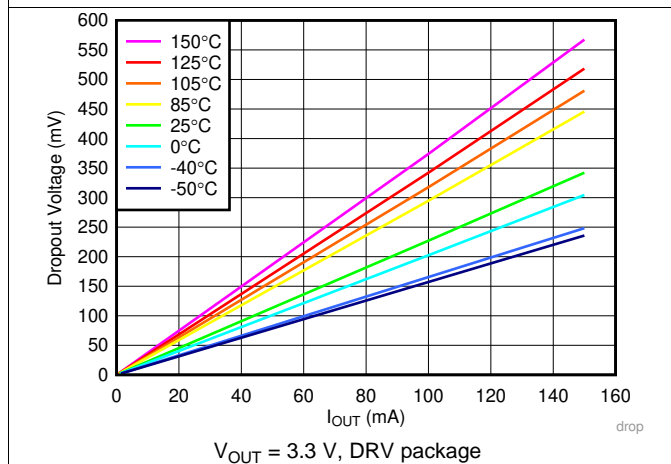


Fig 5. Dropout Voltage vs Output Current

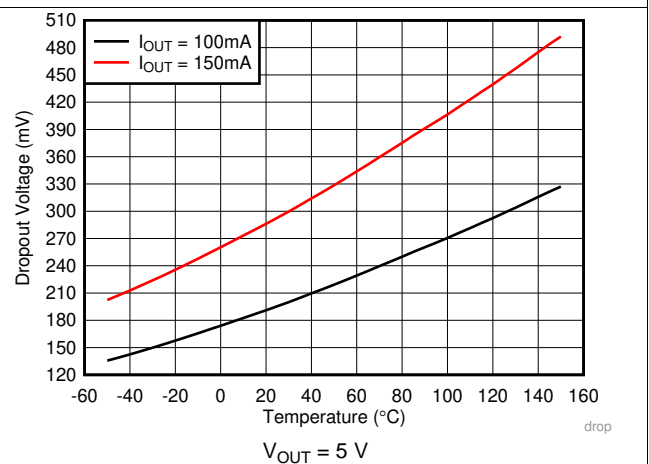
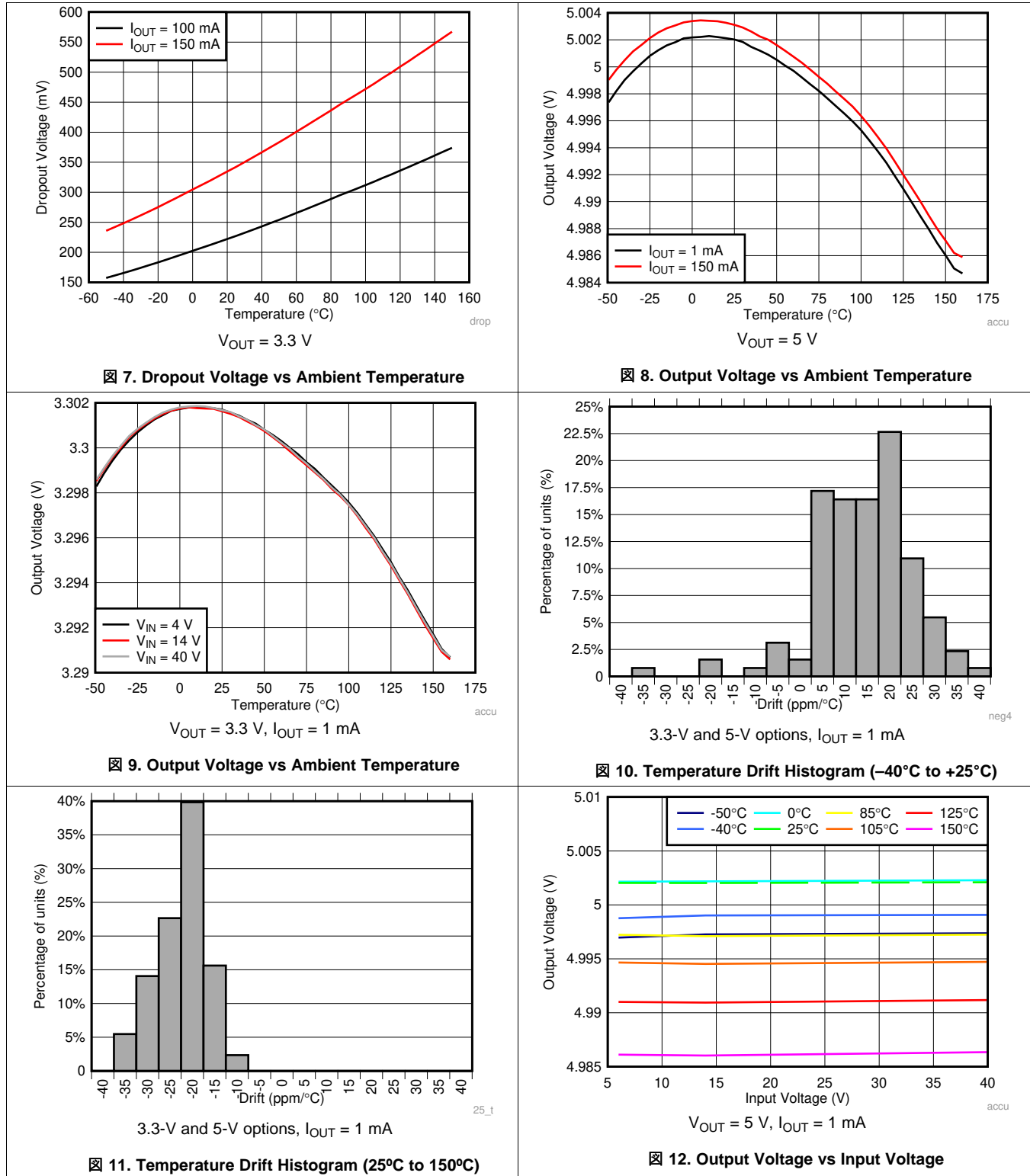


Fig 6. Dropout Voltage vs Ambient Temperature

Typical Characteristics (continued)

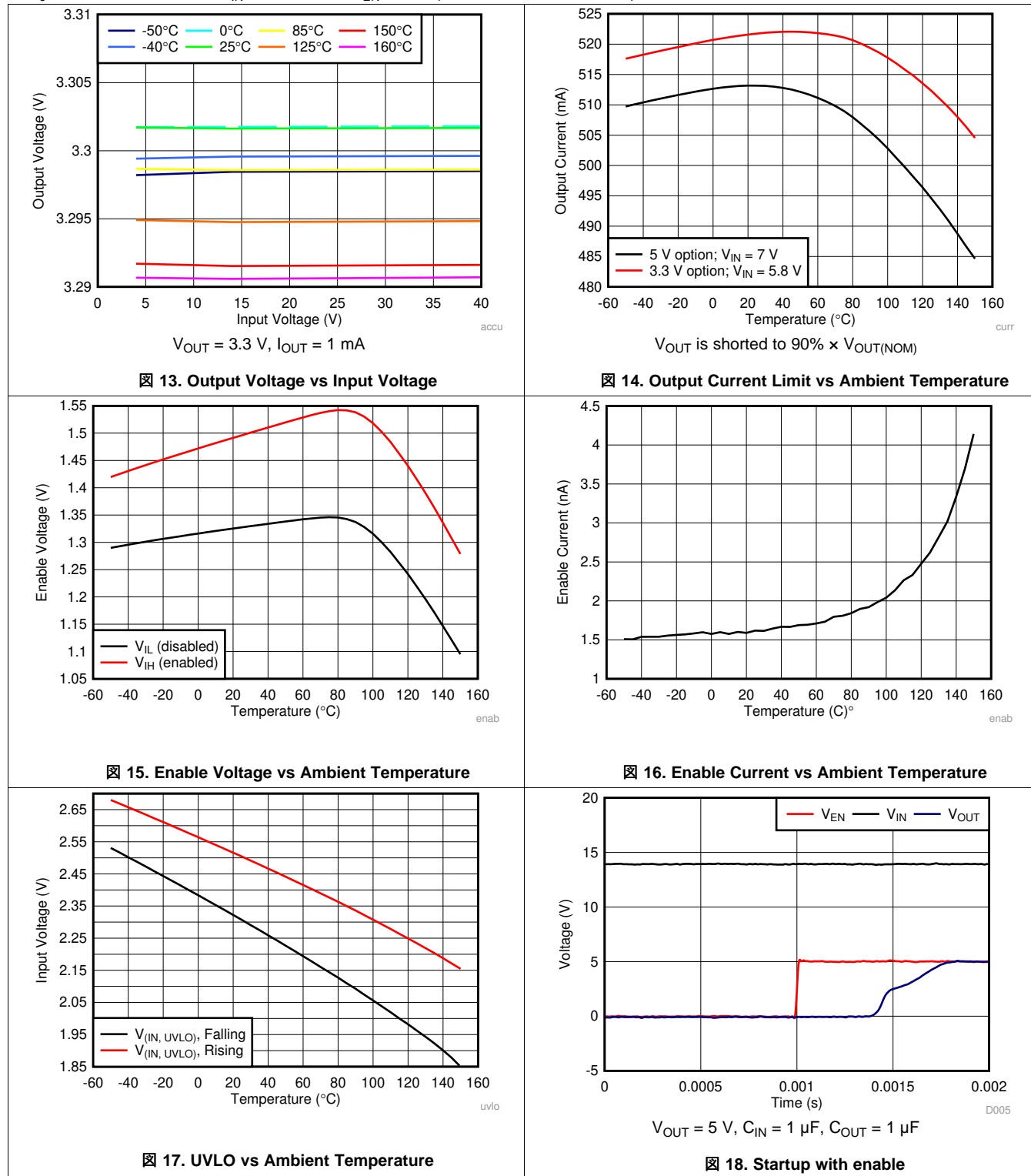
at  $T_J = -40^{\circ}\text{C}$  to  $+150^{\circ}\text{C}$ ,  $V_{IN} = 14\text{ V}$ , and  $V_{EN} \geq 2\text{ V}$  (unless otherwise noted)





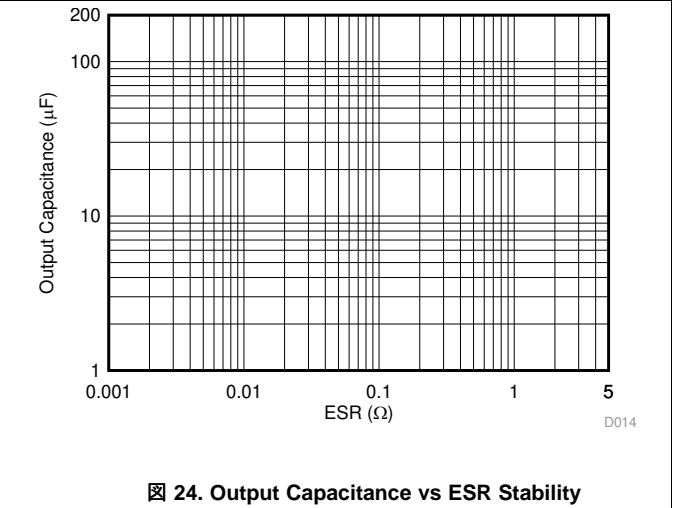
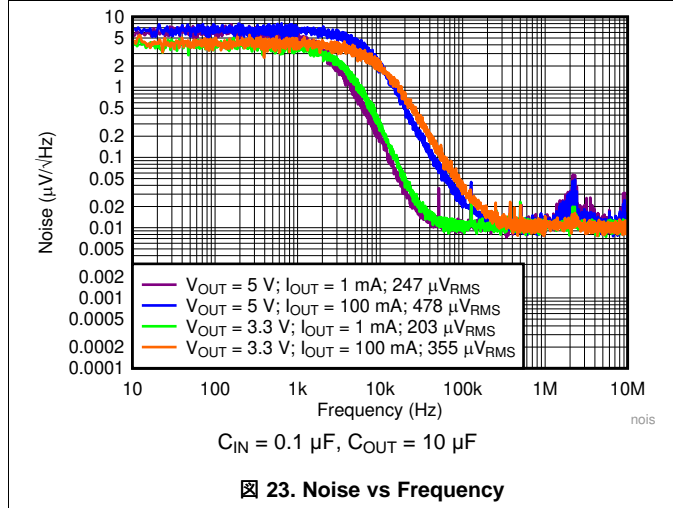
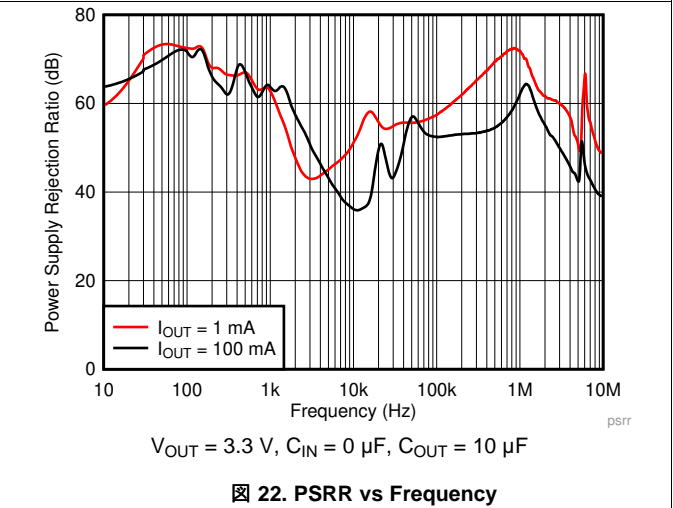
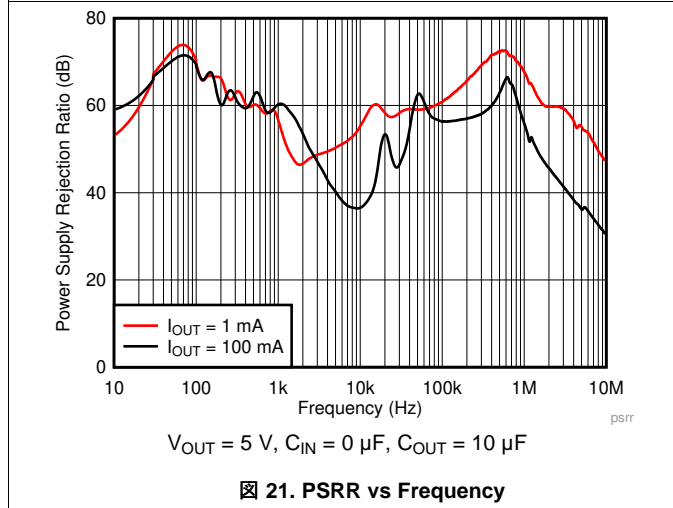
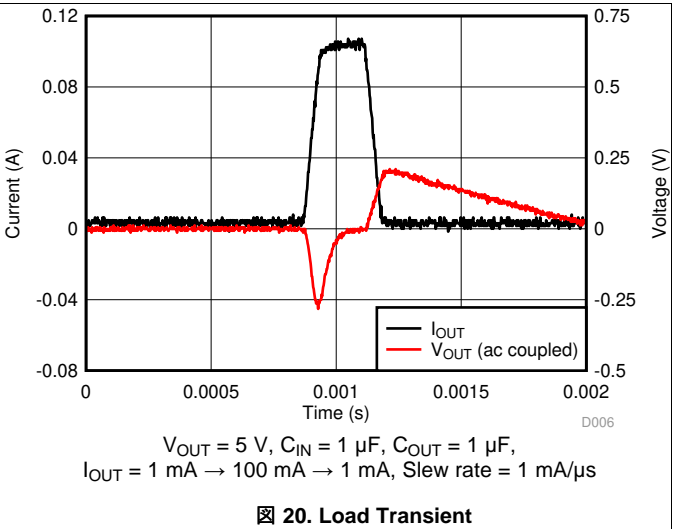
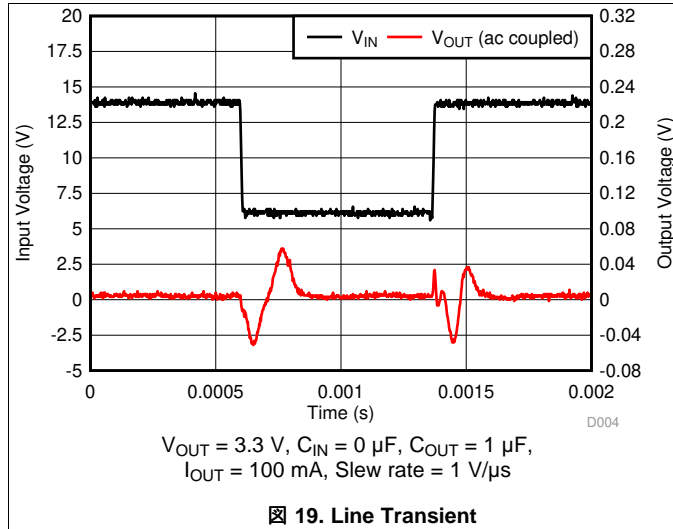
### Typical Characteristics (continued)

at  $T_J = -40^{\circ}\text{C}$  to  $+150^{\circ}\text{C}$ ,  $V_{IN} = 14\text{ V}$ , and  $V_{EN} \geq 2\text{ V}$  (unless otherwise noted)



Typical Characteristics (continued)

at  $T_J = -40^{\circ}\text{C}$  to  $+150^{\circ}\text{C}$ ,  $V_{IN} = 14\text{ V}$ , and  $V_{EN} \geq 2\text{ V}$  (unless otherwise noted)

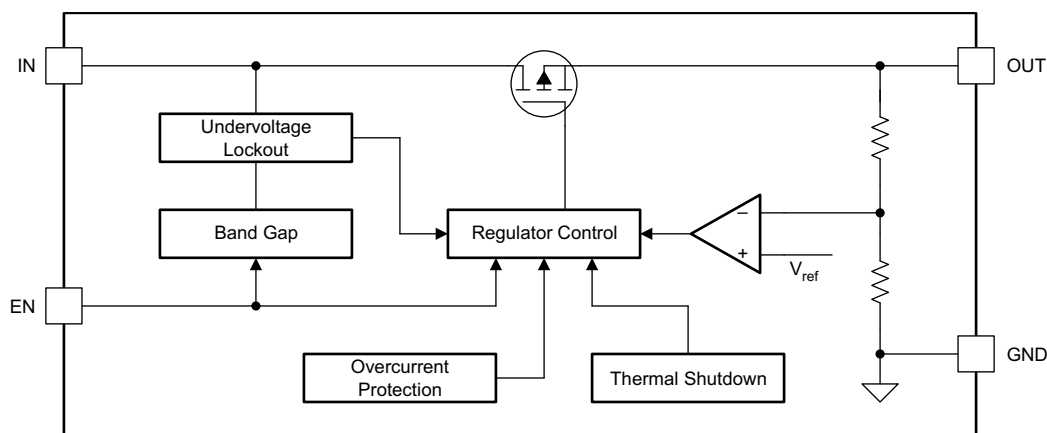


## 7 Detailed Description

### 7.1 Overview

The TPS7B81-Q1 is a 40-V, 150-mA, low-dropout (LDO) linear regulator with ultralow quiescent current. This voltage regulator consumes only 3  $\mu$ A of quiescent current at light load, and is quite suitable for the automotive always-on application.

### 7.2 Functional Block Diagram



### 7.3 Feature Description

#### 7.3.1 Device Enable (EN)

The EN pin is a high-voltage-tolerant pin. A high input activates the device and turns the regulation on. Connect this pin to an external microcontroller or a digital circuit to enable and disable the device, or connect to the IN pin for self-bias applications.

#### 7.3.2 Undervoltage Shutdown

This device has an integrated undervoltage lockout (UVLO) circuit to shut down the output if the input voltage ( $V_{IN}$ ) falls below an internal UVLO threshold ( $V_{(UVLO)}$ ). This feature ensures that the regulator does not latch into an unknown state during low-input-voltage conditions. If the input voltage has a negative transient that drops below the UVLO threshold and recovers, the regulator shuts down and powers up with a normal power-up sequence when the input voltage is above the required level.

#### 7.3.3 Current Limit

This device features current-limit protection to keep the device in a safe operating area when an overload or output short-to-ground condition occurs. This feature protects the device from excessive power dissipation. For example, during a short-circuit condition on the output, the fault protection limits the current through the pass element to  $I_{(LIM)}$  to protect the device from excessive power dissipation.

#### 7.3.4 Thermal Shutdown

This device incorporates a thermal shutdown (TSD) circuit as protection from overheating. For continuous normal operation, the junction temperature must not exceed the TSD trip point. If the junction temperature exceeds the TSD trip point, the output turns off. When the junction temperature falls below the TSD trip point minus the thermal shutdown hysteresis, the output turns on again.

## 7.4 Device Functional Modes

### 7.4.1 Operation With $V_{IN}$ Lower Than 3 V

The device normally operates with input voltages above 3 V. The device can also operate at lower input voltages; the maximum UVLO voltage is 2.7 V. The device does not operate at input voltages below the actual UVLO voltage.

### 7.4.2 Operation With $V_{IN}$ Larger Than 3 V

When  $V_{IN}$  is greater than 3 V, if  $V_{IN}$  is also higher than the output set value plus the device dropout voltage,  $V_{OUT}$  is equal to the set value. Otherwise,  $V_{OUT}$  is equal to  $V_{IN}$  minus the dropout voltage.

表 1. Device Functional Mode Comparison

OPERATING MODE	PARAMETER			
Normal mode	$V_{IN} > V_{OUT(nom)} + V_{(Dropout)}$ and $V_{IN} \geq 3\text{ V}$	$V_{EN} > V_{IH}$	$I_{OUT} < I_{CL}$	$T_J < 160^\circ\text{C}$
Dropout mode	$3\text{ V} \leq V_{IN} < V_{OUT(nom)} + V_{(Dropout)}$	$V_{EN} > V_{IH}$	$I_{OUT} < I_{CL}$	$T_J < 160^\circ\text{C}$
Disabled mode (any true condition disables the device)	$V_{IN} < V_{(IN, UVLO)}$	$V_{EN} < V_{IL}$	—	$T_J > 160^\circ\text{C}$

## 8 Application and Implementation

### 注

Information in the following applications sections is not part of the TI component specification, and TI does not warrant its accuracy or completeness. TI's customers are responsible for determining suitability of components for their purposes. Customers should validate and test their design implementation to confirm system functionality.

### 8.1 Application Information

The TPS7B81-Q1 is a 150-mA, 40-V, low-dropout (LDO) linear regulator with ultralow quiescent current. The PSpice transient model is available for download on the product folder and can be used to evaluate the basic function of the device.

#### 8.1.1 Power Dissipation

Circuit reliability demands that proper consideration is given to device power dissipation, location of the circuit on the printed circuit board (PCB), and correct sizing of the thermal plane. The PCB area around the regulator must be as free as possible of other heat-generating devices that cause added thermal stresses.

As a first-order approximation, power dissipation in the regulator depends on the input-to-output voltage difference and load conditions.  $P_D$  can be approximated using 式 1:

$$P_D = (V_{IN} - V_{OUT}) \times I_{OUT} \quad (1)$$

An important note is that power dissipation can be minimized, and thus greater efficiency achieved, by proper selection of the system voltage rails. Proper selection allows the minimum input-to-output voltage differential to be obtained. The low dropout of the device allows for maximum efficiency across a wide range of output voltages.

The main heat conduction path for the device is through the thermal pad on the package. As such, the thermal pad must be soldered to a copper pad area under the device. This pad area contains an array of plated vias that conduct heat to any inner plane areas or to a bottom-side copper plane.

The maximum power dissipation determines the maximum allowable junction temperature ( $T_J$ ) for the device. Power dissipation and junction temperature are most often related by the junction-to-ambient thermal resistance ( $R_{\theta JA}$ ) of the combined PCB, device package, and the temperature of the ambient air ( $T_A$ ), according to 式 2. The equation is rearranged for output current in 式 3.

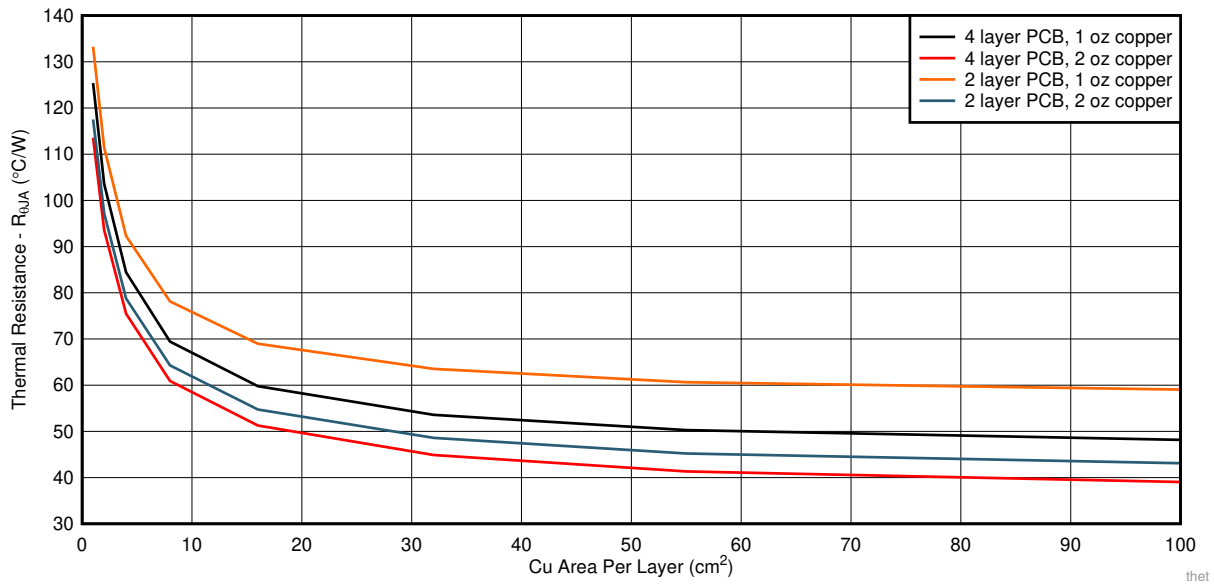
$$T_J = T_A + R_{\theta JA} \times P_D \quad (2)$$

$$I_{OUT} = (T_J - T_A) / [R_{\theta JA} \times (V_{IN} - V_{OUT})] \quad (3)$$

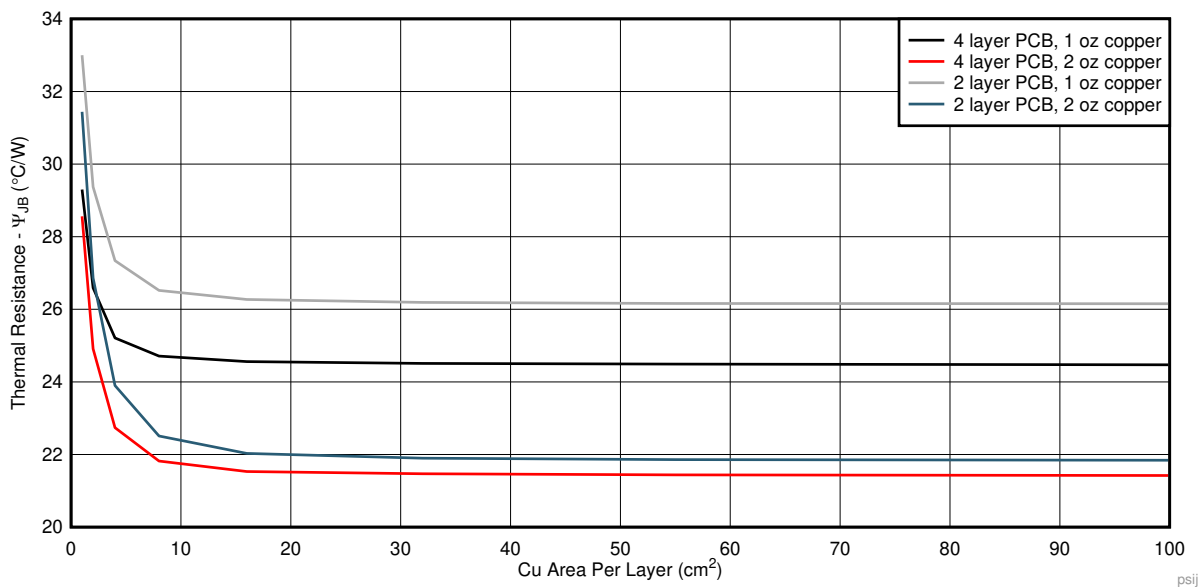
Unfortunately, this thermal resistance ( $R_{\theta JA}$ ) is highly dependent on the heat-spreading capability built into the particular PCB design, and therefore varies according to the total copper area, copper weight, and location of the planes. The  $R_{\theta JA}$  recorded in the v table is determined by the JEDEC standard, PCB, and copper-spreading area, and is only used as a relative measure of package thermal performance. Note that for a well-designed thermal layout,  $R_{\theta JA}$  is actually the sum of the package junction-to-case (bottom) thermal resistance ( $R_{\theta JCbot}$ ) plus the thermal resistance contribution by the PCB copper.

图 25 through 图 30 show the functions of  $R_{\theta JA}$  and  $\psi_{JB}$  vs. copper area and thickness. These plots are generated with a 101.6 mm x 101.6 mm x 1.6mm PCB of two and four layers. For the four layer board, inner planes use 1 oz copper thickness. Outer layers are simulated with both 1 oz and 2 oz copper thickness. A 2 x 1 array of thermal vias of 300  $\mu$ m drill diameter and 25  $\mu$ m Cu plating is located beneath the thermal pad of the device. The thermal vias connect the top layer, the bottom layer and, in the case of the 4-layer board, the first inner GND plane. Each of the layers has a copper plane of equal area.

**Application Information (continued)**

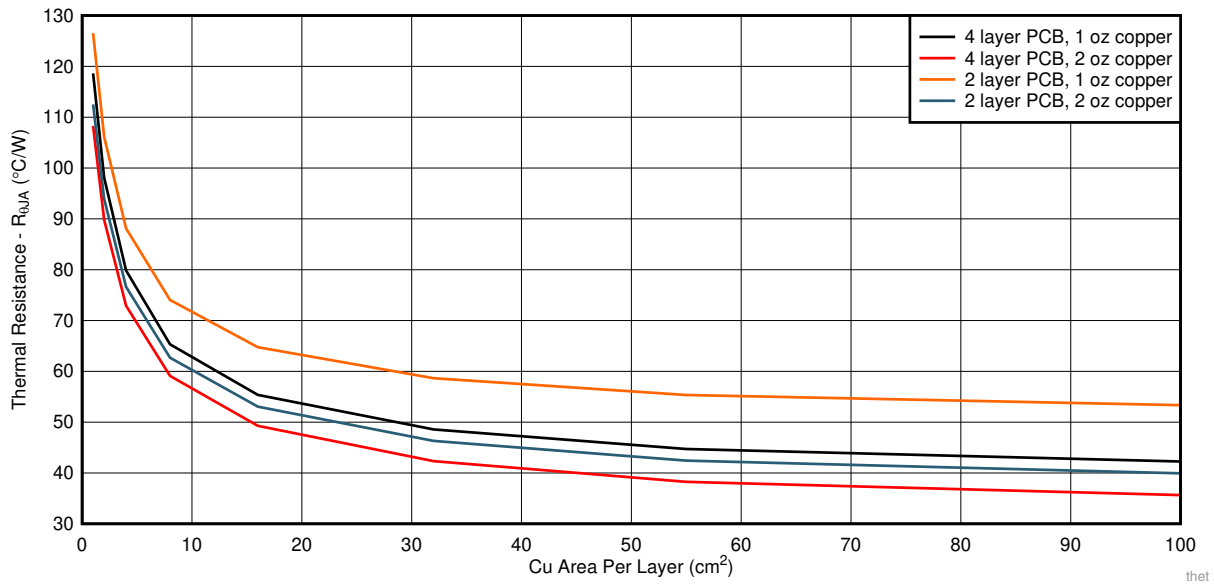


**Figure 25.  $R_{\theta JA}$  versus Cu Area for the WSON (DRV) Package**

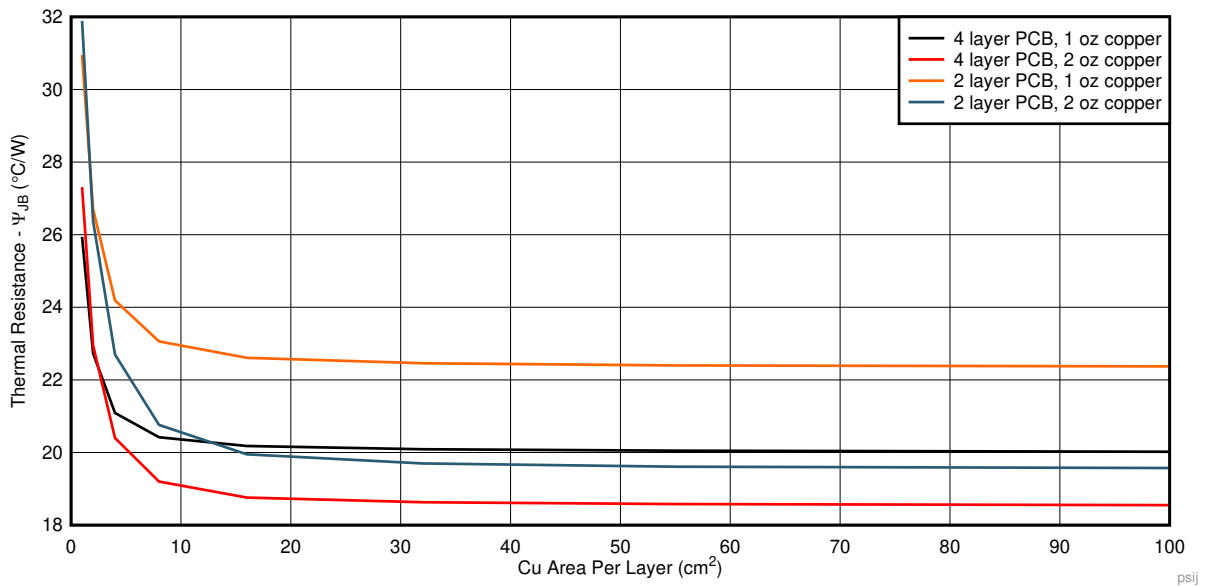


**Figure 26.  $\psi_{JB}$  versus Cu Area for the WSON (DRV) Package**

Application Information (continued)

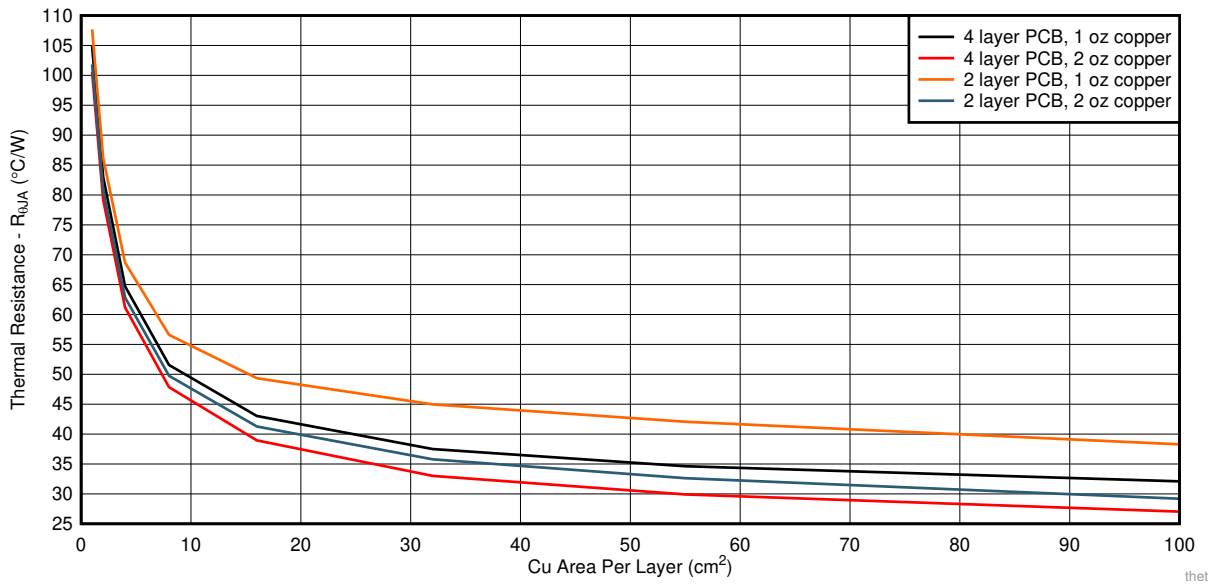


27.  $R_{\theta JA}$  versus Cu Area for the HVSSOP (DGN) Package

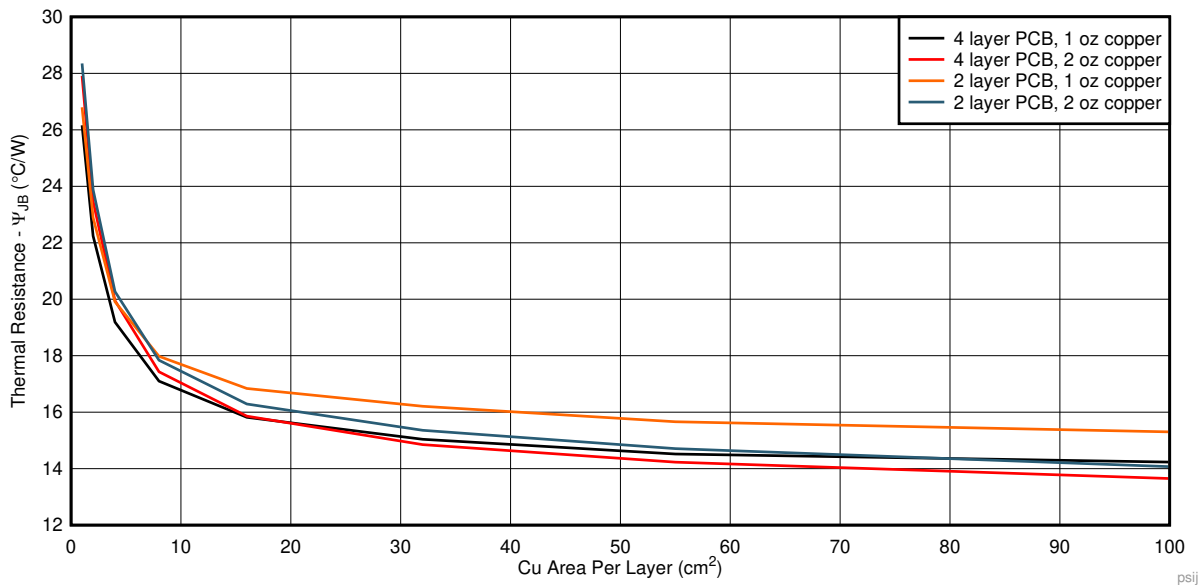


28.  $\psi_{JB}$  versus Cu Area for the HVSSOP (DGN) Package

**Application Information (continued)**



**29.  $R_{\theta JA}$  versus Cu Area for the TO-252 (KVU) Package**



**30.  $\psi_{JB}$  versus Cu Area for the TO-252 (KVU) Package**



## Application Information (continued)

### 8.1.1.1 Estimating Junction Temperature

The JEDEC standard now recommends the use of psi ( $\Psi$ ) thermal metrics to estimate the junction temperatures of the LDO when in-circuit on a typical PCB board application. These metrics are not strictly speaking thermal resistances, but rather offer practical and relative means of estimating junction temperatures. These psi metrics are determined to be significantly independent of the copper-spreading area. The key thermal metrics ( $\Psi_{JT}$  and  $\Psi_{JB}$ ) are given in the [Thermal Information](#) table and are used in accordance with [式 4](#).

$$\Psi_{JT}: T_J = T_T + \Psi_{JT} \times P_D$$

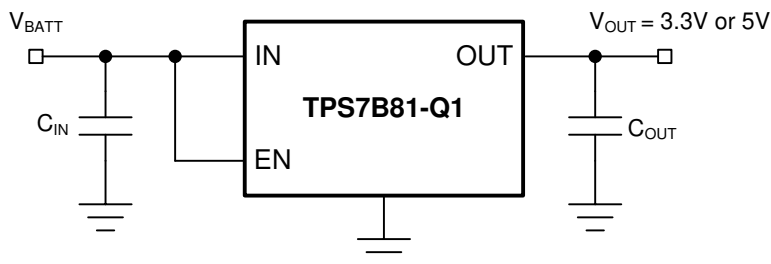
$$\Psi_{JB}: T_J = T_B + \Psi_{JB} \times P_D$$

where:

- $P_D$  is the power dissipated as explained in [式 1](#)
  - $T_T$  is the temperature at the center-top of the device package, and
  - $T_B$  is the PCB surface temperature measured 1 mm from the device package and centered on the package edge
- (4)

## 8.2 Typical Application

[图 31](#) shows a typical application circuit for the TPS7B81-Q1. Different external component values can be used, depending on the end application. An application may require a larger output capacitor during fast load steps to prevent a large drop on the output voltage. TI recommends using a low-equivalent series resistance (ESR) ceramic capacitor with an X5R- or X7R-type dielectric.



**图 31. TPS7B81-Q1 Typical Application Schematic**

### 8.2.1 Design Requirements

Use the parameters listed in [表 2](#) for this design example.

**表 2. Design Requirements Parameters**

PARAMETER	VALUE
Input voltage range	3 V to 40 V
Output voltage	5 V or 3.3 V
Output current	150 mA maximum

### 8.2.2 Detailed Design Procedure

To begin the design process, determine the following:

- Input voltage range
- Output voltage
- Output current

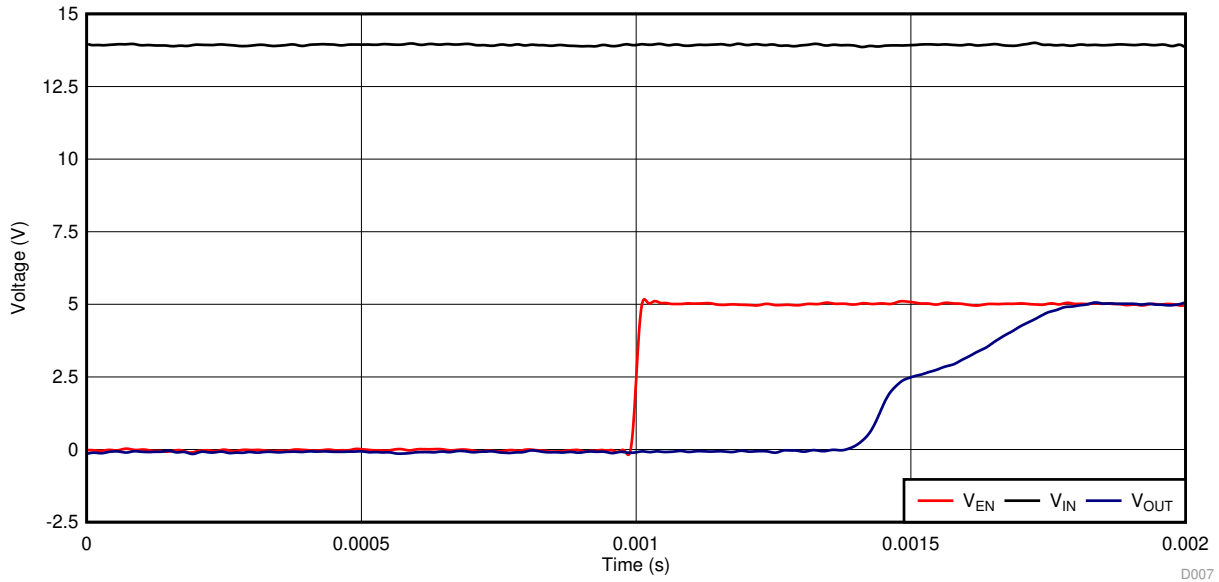
#### 8.2.2.1 Input Capacitor

Although an input capacitor is not required for stability, good analog design practice is to connect a 10- $\mu$ F to 22- $\mu$ F capacitor from IN to GND. This capacitor counteracts reactive input sources and improves transient response, input ripple rejection, and PSRR. The voltage rating must be greater than the maximum input voltage.

### 8.2.2.2 Output Capacitor

To ensure the stability of the TPS7B81-Q1, the device requires an output capacitor with a value in the range from 1  $\mu\text{F}$  to 200  $\mu\text{F}$  and with an ESR range between 0.001  $\Omega$  and 5  $\Omega$ . TI recommends selecting a ceramic capacitor with low ESR to improve the load transient response.

### 8.2.3 Application Curve



⊠ 32. TPS7B81-Q1 Power-Up Waveform (5 V)

## 9 Power Supply Recommendations

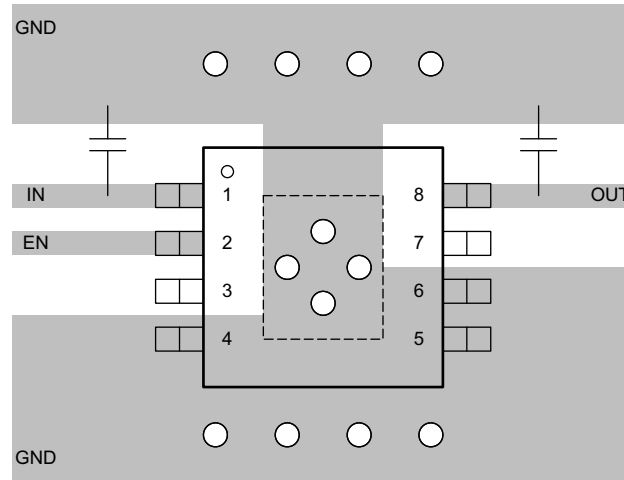
The device is designed to operate from an input-voltage supply range from 3 V to 40 V. The input supply must be well regulated. If the input supply is located more than a few inches from the TPS7B81-Q1, TI recommends adding a capacitor with a value greater than or equal to 10  $\mu\text{F}$  with a 0.1- $\mu\text{F}$  bypass capacitor in parallel at the input.

## 10 Layout

### 10.1 Layout Guidelines

Layout is an important step for LDO power supplies, especially for high-voltage and large-output-current supplies. If the layout is not carefully designed, the regulator can fail to deliver enough output current because of thermal limitations. To improve the thermal performance of the device, and to maximize the current output at high ambient temperature, spread the copper under the thermal pad as far as possible and put enough thermal vias on the copper under the thermal pad. [Figure 33](#) shows an example layout.

### 10.2 Layout Example



**Figure 33. TPS7B81-Q1 Example Layout Diagram**

## 11 デバイスおよびドキュメントのサポート

### 11.1 ドキュメントの更新通知を受け取る方法

ドキュメントの更新についての通知を受け取るには、[ti.com](http://ti.com)のデバイス製品フォルダを開いてください。右上の「アラートを受け取る」をクリックして登録すると、変更されたすべての製品情報に関するダイジェストを毎週受け取れます。変更の詳細については、修正されたドキュメントに含まれている改訂履歴をご覧ください。

### 11.2 サポート・リソース

[TI E2E™ support forums](#) are an engineer's go-to source for fast, verified answers and design help — straight from the experts. Search existing answers or ask your own question to get the quick design help you need.

Linked content is provided "AS IS" by the respective contributors. They do not constitute TI specifications and do not necessarily reflect TI's views; see TI's [Terms of Use](#).

### 11.3 商標

PowerPAD, E2E are trademarks of Texas Instruments.  
All other trademarks are the property of their respective owners.

### 11.4 静電気放電に関する注意事項



すべての集積回路は、適切なESD保護方法を用いて、取扱いと保存を行うようにして下さい。

静電気放電はわずかな性能の低下から完全なデバイスの故障に至るまで、様々な損傷を与えます。高精度の集積回路は、損傷に対して敏感であり、極めてわずかなパラメータの変化により、デバイスに規定された仕様に適合しなくなる場合があります。

### 11.5 Glossary

[SLYZ022](#) — *TI Glossary*.

This glossary lists and explains terms, acronyms, and definitions.

## 12 メカニカル、パッケージ、および注文情報

以降のページには、メカニカル、パッケージ、および注文に関する情報が記載されています。この情報は、そのデバイスについて利用可能な最新のデータです。このデータは予告なく変更されることがあり、ドキュメントが改訂される場合もあります。本データシートのブラウザ版を使用されている場合は、画面左側の説明をご覧ください。

**PACKAGING INFORMATION**

Orderable Device	Status (1)	Package Type	Package Drawing	Pins	Package Qty	Eco Plan (2)	Lead finish/ Ball material (6)	MSL Peak Temp (3)	Op Temp (°C)	Device Marking (4/5)	Samples
TPS7B8125QDGNRQ1	ACTIVE	HVSSOP	DGN	8	2500	RoHS & Green	NIPDAUAG	Level-2-260C-1 YEAR	-40 to 150	26GX	<a href="#">Samples</a>
TPS7B8133QDGNRQ1	ACTIVE	HVSSOP	DGN	8	2500	RoHS & Green	NIPDAUAG	Level-2-260C-1 YEAR	-40 to 150	1VTX	<a href="#">Samples</a>
TPS7B8133QDRVRQ1	ACTIVE	WSO	DRV	6	3000	RoHS & Green	NIPDAU	Level-2-260C-1 YEAR	-40 to 150	1X2H	<a href="#">Samples</a>
TPS7B8133QKVURQ1	ACTIVE	TO-252	KVU	5	2500	RoHS & Green	SN	Level-3-260C-168 HR	-40 to 150	7B8133Q1	<a href="#">Samples</a>
TPS7B8150QDGNRQ1	ACTIVE	HVSSOP	DGN	8	2500	RoHS & Green	NIPDAUAG	Level-2-260C-1 YEAR	-40 to 150	1VUX	<a href="#">Samples</a>
TPS7B8150QDRVRQ1	ACTIVE	WSO	DRV	6	3000	RoHS & Green	NIPDAU	Level-2-260C-1 YEAR	-40 to 150	1WNH	<a href="#">Samples</a>
TPS7B8150QKVURQ1	ACTIVE	TO-252	KVU	5	2500	RoHS & Green	SN	Level-3-260C-168 HR	-40 to 150	7B8150Q1	<a href="#">Samples</a>

(1) The marketing status values are defined as follows:

**ACTIVE:** Product device recommended for new designs.

**LIFEBUY:** TI has announced that the device will be discontinued, and a lifetime-buy period is in effect.

**NRND:** Not recommended for new designs. Device is in production to support existing customers, but TI does not recommend using this part in a new design.

**PREVIEW:** Device has been announced but is not in production. Samples may or may not be available.

**OBSOLETE:** TI has discontinued the production of the device.

(2) **RoHS:** TI defines "RoHS" to mean semiconductor products that are compliant with the current EU RoHS requirements for all 10 RoHS substances, including the requirement that RoHS substance do not exceed 0.1% by weight in homogeneous materials. Where designed to be soldered at high temperatures, "RoHS" products are suitable for use in specified lead-free processes. TI may reference these types of products as "Pb-Free".

**RoHS Exempt:** TI defines "RoHS Exempt" to mean products that contain lead but are compliant with EU RoHS pursuant to a specific EU RoHS exemption.

**Green:** TI defines "Green" to mean the content of Chlorine (Cl) and Bromine (Br) based flame retardants meet JS709B low halogen requirements of <=1000ppm threshold. Antimony trioxide based flame retardants must also meet the <=1000ppm threshold requirement.

(3) MSL, Peak Temp. - The Moisture Sensitivity Level rating according to the JEDEC industry standard classifications, and peak solder temperature.

(4) There may be additional marking, which relates to the logo, the lot trace code information, or the environmental category on the device.

(5) Multiple Device Markings will be inside parentheses. Only one Device Marking contained in parentheses and separated by a "~" will appear on a device. If a line is indented then it is a continuation of the previous line and the two combined represent the entire Device Marking for that device.

<sup>(6)</sup> Lead finish/Ball material - Orderable Devices may have multiple material finish options. Finish options are separated by a vertical ruled line. Lead finish/Ball material values may wrap to two lines if the finish value exceeds the maximum column width.

**Important Information and Disclaimer:**The information provided on this page represents TI's knowledge and belief as of the date that it is provided. TI bases its knowledge and belief on information provided by third parties, and makes no representation or warranty as to the accuracy of such information. Efforts are underway to better integrate information from third parties. TI has taken and continues to take reasonable steps to provide representative and accurate information but may not have conducted destructive testing or chemical analysis on incoming materials and chemicals. TI and TI suppliers consider certain information to be proprietary, and thus CAS numbers and other limited information may not be available for release.

In no event shall TI's liability arising out of such information exceed the total purchase price of the TI part(s) at issue in this document sold by TI to Customer on an annual basis.

**OTHER QUALIFIED VERSIONS OF TPS7B81-Q1 :**

- Catalog : [TPS7B81](#)

NOTE: Qualified Version Definitions:

- Catalog - TI's standard catalog product

**TAPE AND REEL INFORMATION**

**QUADRANT ASSIGNMENTS FOR PIN 1 ORIENTATION IN TAPE**


\*All dimensions are nominal

Device	Package Type	Package Drawing	Pins	SPQ	Reel Diameter (mm)	Reel Width W1 (mm)	A0 (mm)	B0 (mm)	K0 (mm)	P1 (mm)	W (mm)	Pin1 Quadrant
TPS7B8125QDGNRQ1	HVSSOP	DGN	8	2500	330.0	12.4	5.3	3.4	1.4	8.0	12.0	Q1
TPS7B8133QDGNRQ1	HVSSOP	DGN	8	2500	330.0	12.4	5.3	3.4	1.4	8.0	12.0	Q1
TPS7B8133QDRVRQ1	WSO	DRV	6	3000	180.0	8.4	2.3	2.3	1.15	4.0	8.0	Q2
TPS7B8133QKVURQ1	TO-252	KVU	5	2500	330.0	16.4	6.9	10.5	2.7	8.0	16.0	Q2
TPS7B8150QDGNRQ1	HVSSOP	DGN	8	2500	330.0	12.4	5.3	3.4	1.4	8.0	12.0	Q1
TPS7B8150QDRVRQ1	WSO	DRV	6	3000	180.0	8.4	2.3	2.3	1.15	4.0	8.0	Q2
TPS7B8150QKVURQ1	TO-252	KVU	5	2500	330.0	16.4	6.9	10.5	2.7	8.0	16.0	Q2

**TAPE AND REEL BOX DIMENSIONS**


\*All dimensions are nominal

Device	Package Type	Package Drawing	Pins	SPQ	Length (mm)	Width (mm)	Height (mm)
TPS7B8125QDGNRQ1	HVSSOP	DGN	8	2500	366.0	364.0	50.0
TPS7B8133QDGNRQ1	HVSSOP	DGN	8	2500	366.0	364.0	50.0
TPS7B8133QDRVRQ1	WSON	DRV	6	3000	210.0	185.0	35.0
TPS7B8133QKVURQ1	TO-252	KVU	5	2500	340.0	340.0	38.0
TPS7B8150QDGNRQ1	HVSSOP	DGN	8	2500	366.0	364.0	50.0
TPS7B8150QDRVRQ1	WSON	DRV	6	3000	210.0	185.0	35.0
TPS7B8150QKVURQ1	TO-252	KVU	5	2500	340.0	340.0	38.0



## GENERIC PACKAGE VIEW

DRV 6

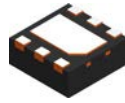
WSO - 0.8 mm max height

PLASTIC SMALL OUTLINE - NO LEAD



Images above are just a representation of the package family, actual package may vary.  
Refer to the product data sheet for package details.

4206925/F



4222173/B 04/2018

NOTES:

1. All linear dimensions are in millimeters. Any dimensions in parenthesis are for reference only. Dimensioning and tolerancing per ASME Y14.5M.
2. This drawing is subject to change without notice.
3. The package thermal pad must be soldered to the printed circuit board for thermal and mechanical performance.

# EXAMPLE BOARD LAYOUT

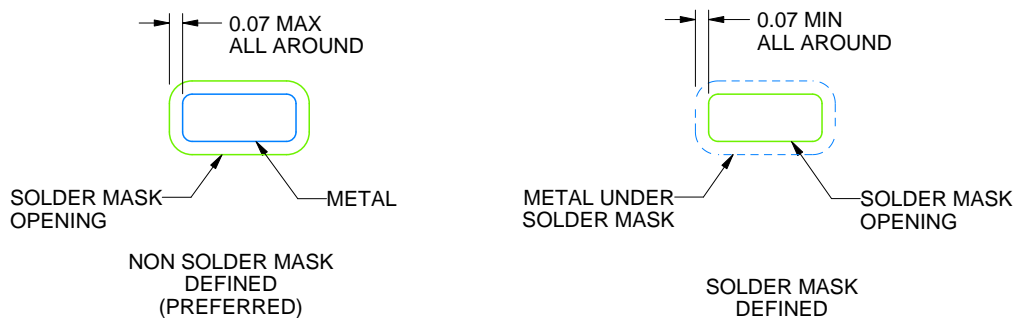
DRV0006A

WSON - 0.8 mm max height

PLASTIC SMALL OUTLINE - NO LEAD



LAND PATTERN EXAMPLE  
SCALE:25X



SOLDER MASK DETAILS

4222173/B 04/2018

NOTES: (continued)

4. This package is designed to be soldered to a thermal pad on the board. For more information, see Texas Instruments literature number SLUA271 ([www.ti.com/lit/sluea271](http://www.ti.com/lit/sluea271)).
5. Vias are optional depending on application, refer to device data sheet. If some or all are implemented, recommended via locations are shown.

# EXAMPLE STENCIL DESIGN

DRV0006A

WSON - 0.8 mm max height

PLASTIC SMALL OUTLINE - NO LEAD



SOLDER PASTE EXAMPLE  
BASED ON 0.125 mm THICK STENCIL

EXPOSED PAD #7  
88% PRINTED SOLDER COVERAGE BY AREA UNDER PACKAGE  
SCALE:30X

4222173/B 04/2018

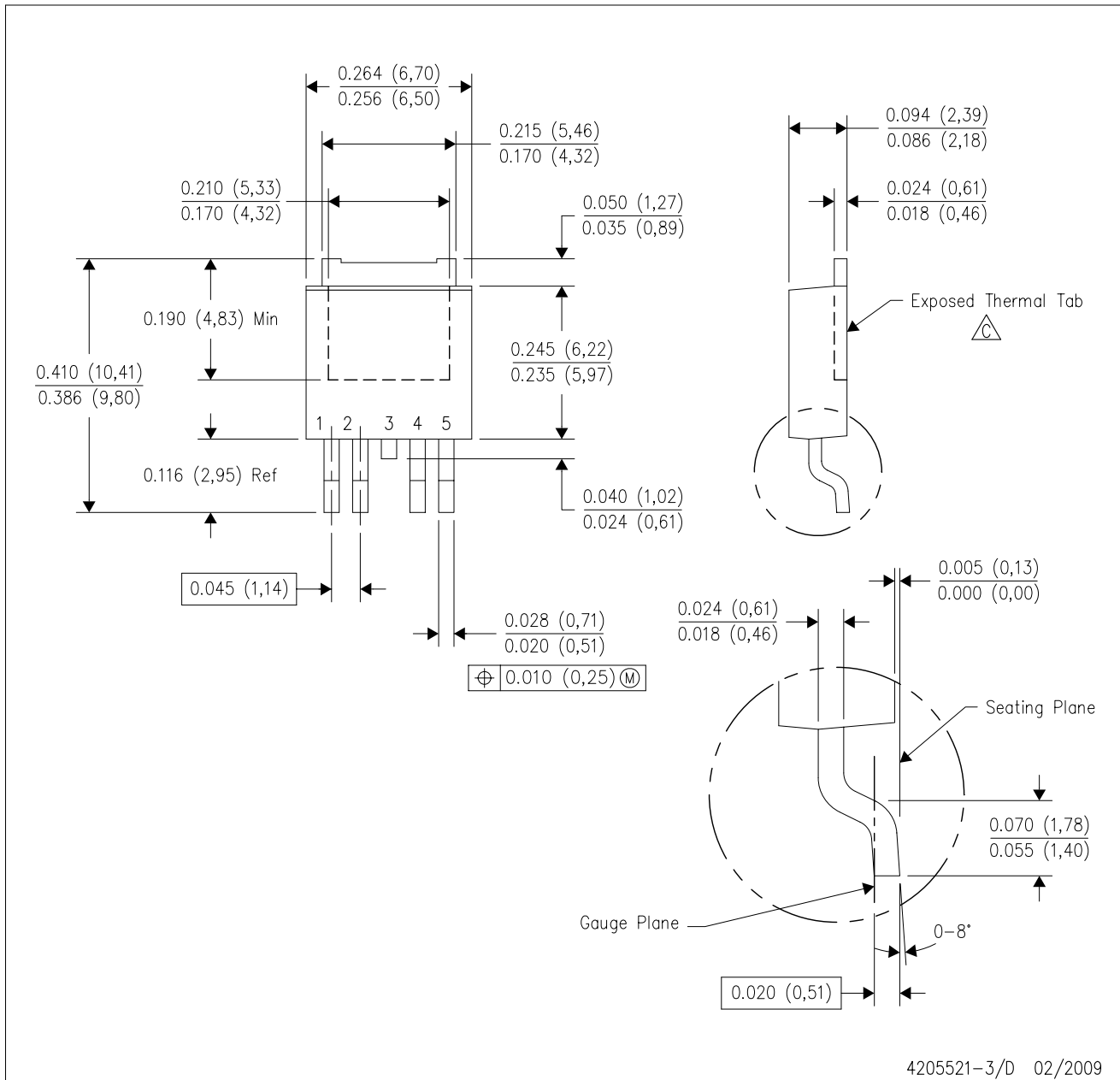
NOTES: (continued)

6. Laser cutting apertures with trapezoidal walls and rounded corners may offer better paste release. IPC-7525 may have alternate design recommendations.

# MECHANICAL DATA

KVU (R-PSFM-G5)

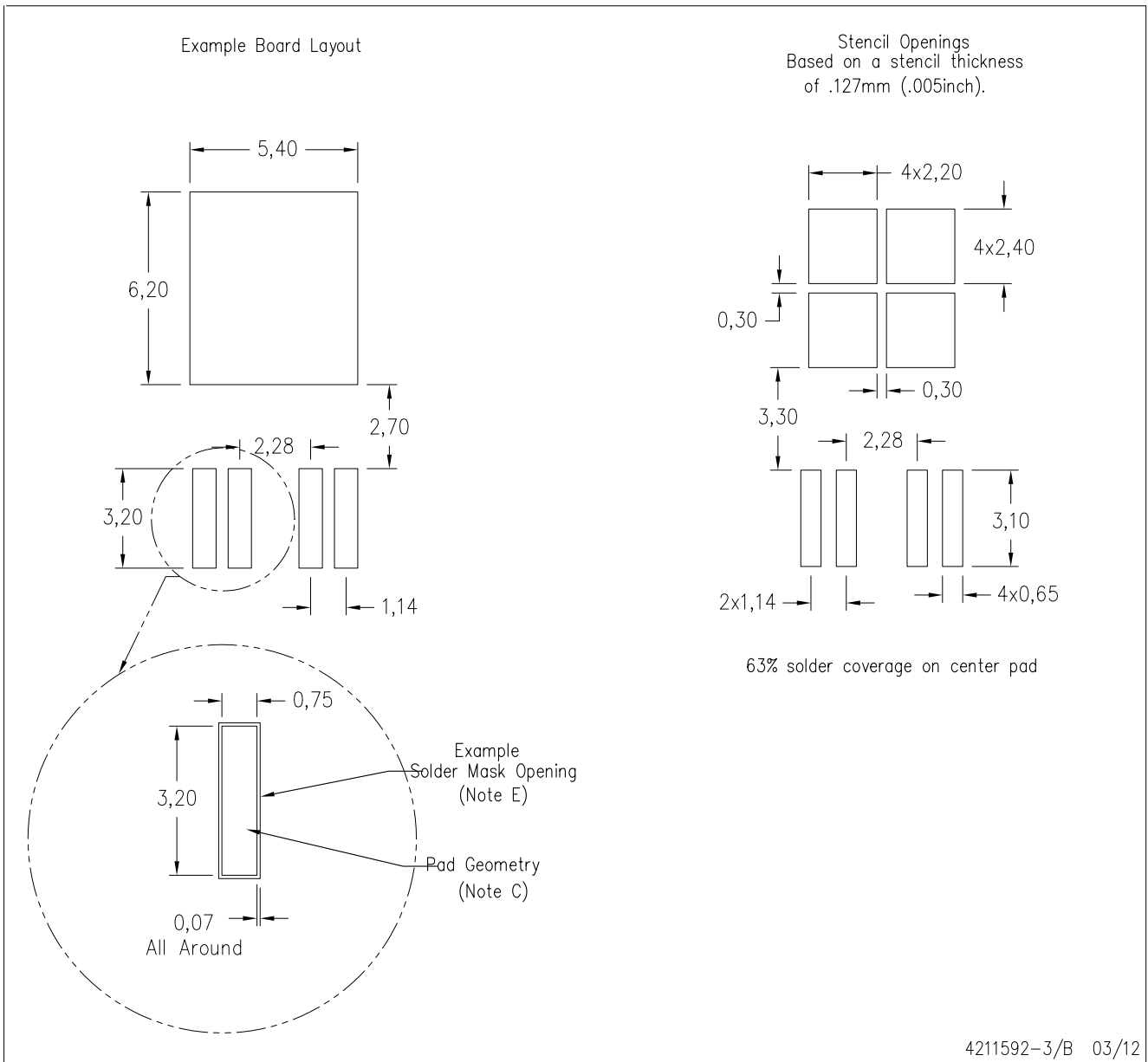
PLASTIC FLANGE-MOUNT PACKAGE



- NOTES:
- A. All linear dimensions are in inches (millimeters).
  - B. This drawing is subject to change without notice.
  - $\triangle C$  The center lead is in electrical contact with the exposed thermal tab.
  - D. Body Dimensions do not include mold flash or protrusions. Mold flash and protrusion shall not exceed 0.006 (0,15) per side.
  - E. Falls within JEDEC TO-252 variation AD.

KVU (R-PSFM-G5)

PLASTIC FLANGE MOUNT PACKAGE



- NOTES:
- All linear dimensions are in millimeters.
  - This drawing is subject to change without notice.
  - Publication IPC-SM-782 is an alternate information source for PCB land pattern designs.
  - Laser cutting apertures with trapezoidal walls and also rounding corners will offer better paste release. Customers should contact their board assembly site for stencil design recommendations. Refer to IPC-7525 for other stencil recommendations.
  - Customers should contact their board fabrication site for recommended solder mask tolerances and via tenting recommendations for vias placed in thermal pad.

## GENERIC PACKAGE VIEW

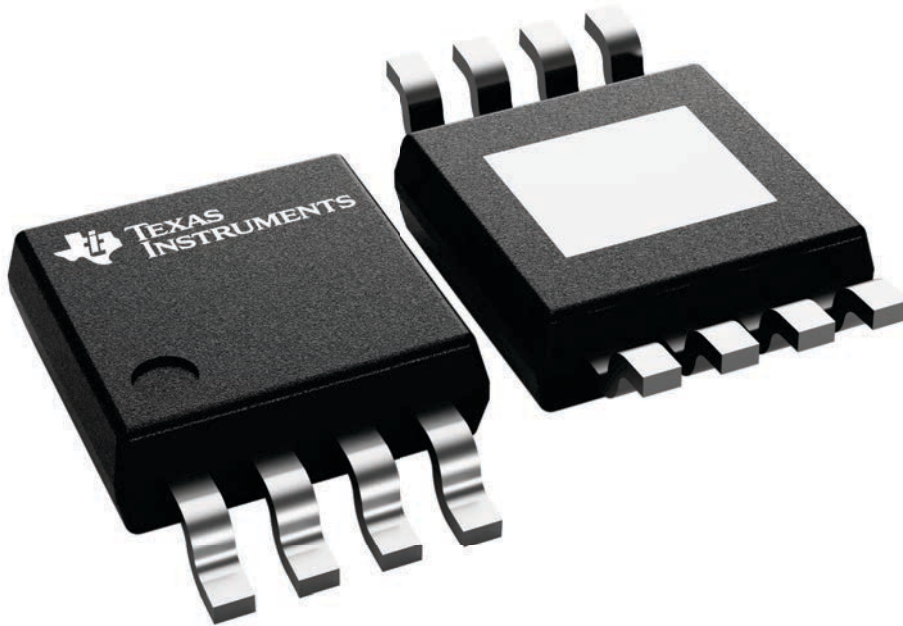
**DGN 8**

**PowerPAD™ HVSSOP - 1.1 mm max height**

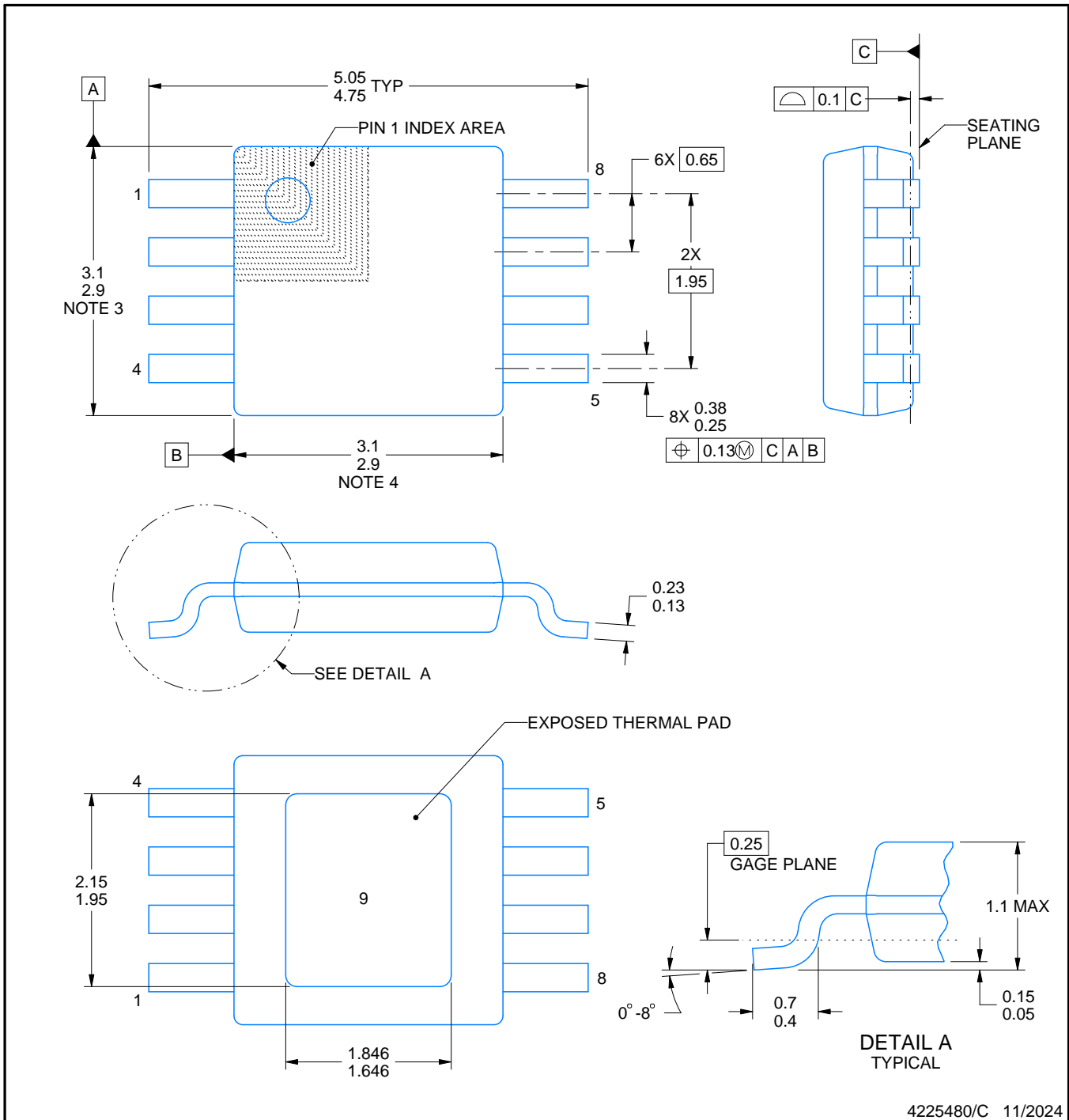
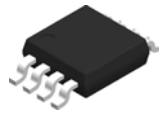
3 x 3, 0.65 mm pitch

SMALL OUTLINE PACKAGE

This image is a representation of the package family, actual package may vary.  
Refer to the product data sheet for package details.



4225482/B



4225480/C 11/2024

PowerPAD is a trademark of Texas Instruments.

NOTES:

1. All linear dimensions are in millimeters. Any dimensions in parenthesis are for reference only. Dimensioning and tolerancing per ASME Y14.5M.
2. This drawing is subject to change without notice.
3. This dimension does not include mold flash, protrusions, or gate burrs. Mold flash, protrusions, or gate burrs shall not exceed 0.15 mm per side.
4. This dimension does not include interlead flash. Interlead flash shall not exceed 0.25 mm per side.
5. Reference JEDEC registration MO-187.

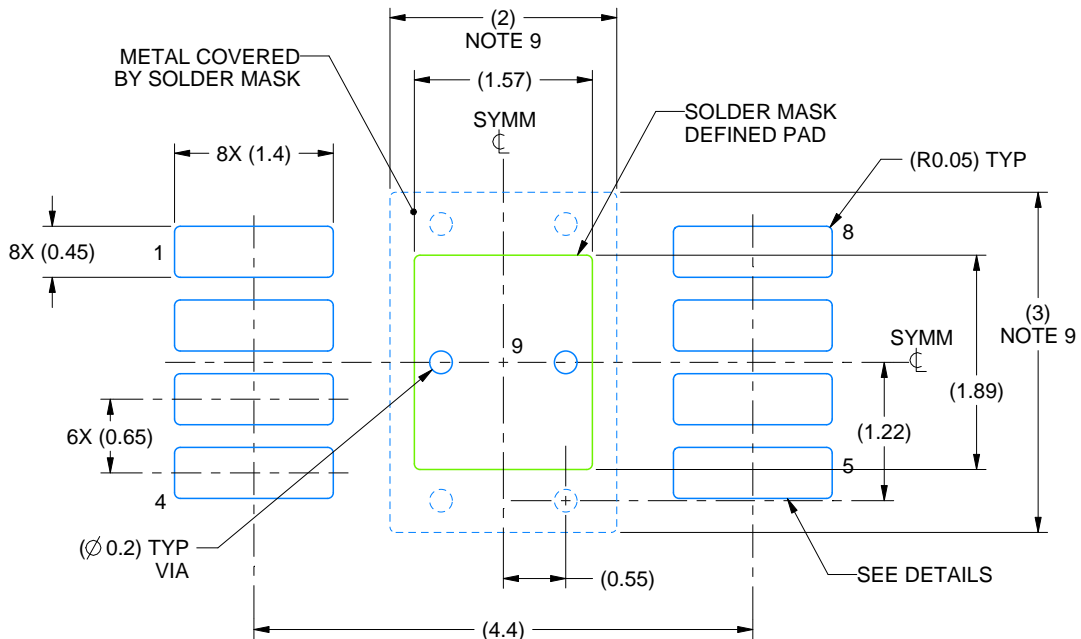


# EXAMPLE BOARD LAYOUT

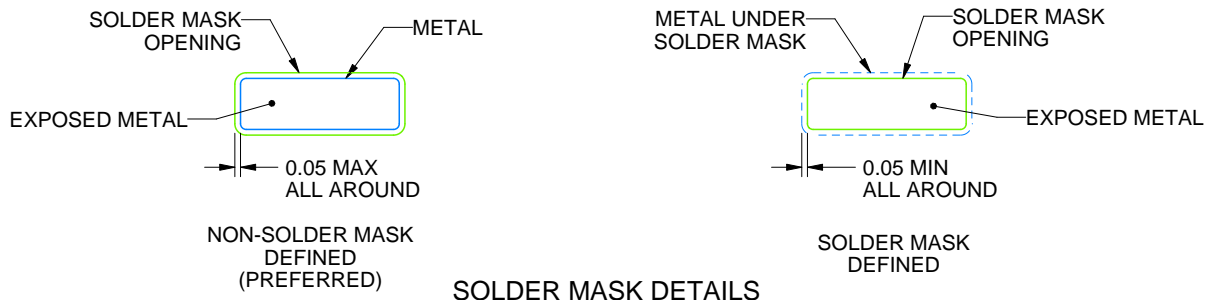
DGN0008G

PowerPAD™ HVSSOP - 1.1 mm max height

SMALL OUTLINE PACKAGE



LAND PATTERN EXAMPLE  
EXPOSED METAL SHOWN  
SCALE: 15X



SOLDER MASK DETAILS

4225480/C 11/2024

NOTES: (continued)

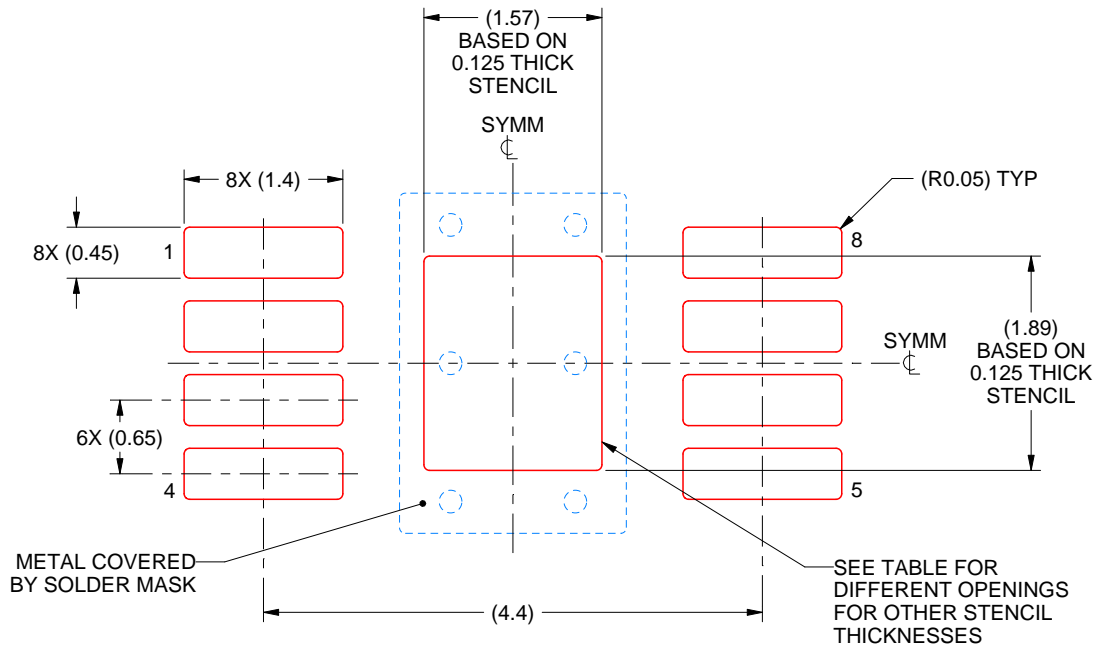
- 6. Publication IPC-7351 may have alternate designs.
- 7. Solder mask tolerances between and around signal pads can vary based on board fabrication site.
- 8. Vias are optional depending on application, refer to device data sheet. If any vias are implemented, refer to their locations shown on this view. It is recommended that vias under paste be filled, plugged or tented.
- 9. Size of metal pad may vary due to creepage requirement.

# EXAMPLE STENCIL DESIGN

DGN0008G

PowerPAD™ HVSSOP - 1.1 mm max height

SMALL OUTLINE PACKAGE



**SOLDER PASTE EXAMPLE**  
EXPOSED PAD 9:  
100% PRINTED SOLDER COVERAGE BY AREA  
SCALE: 15X

STENCIL THICKNESS	SOLDER STENCIL OPENING
0.1	1.76 X 2.11
0.125	1.57 X 1.89 (SHOWN)
0.15	1.43 X 1.73
0.175	1.33 X 1.60

4225480/C 11/2024

NOTES: (continued)

10. Laser cutting apertures with trapezoidal walls and rounded corners may offer better paste release. IPC-7525 may have alternate design recommendations.
11. Board assembly site may have different recommendations for stencil design.

## 重要なお知らせと免責事項

テキサス・インスツルメンツは、技術データと信頼性データ(データシートを含みます)、設計リソース(リファレンス デザインを含みます)、アプリケーションや設計に関する各種アドバイス、Web ツール、安全性情報、その他のリソースを、欠陥が存在する可能性のある「現状のまま」提供しており、商品性および特定目的に対する適合性の黙示保証、第三者の知的財産権の非侵害保証を含むいかなる保証も、明示的または黙示的にかかわらず拒否します。

これらのリソースは、テキサス・インスツルメンツ製品を使用する設計の経験を積んだ開発者への提供を意図したものです。(1) お客様のアプリケーションに適したテキサス・インスツルメンツ製品の選定、(2) お客様のアプリケーションの設計、検証、試験、(3) お客様のアプリケーションに該当する各種規格や、その他のあらゆる安全性、セキュリティ、規制、または他の要件への確実な適合に関する責任を、お客様のみが単独で負うものとし、ます。

上記の各種リソースは、予告なく変更される可能性があります。これらのリソースは、リソースで説明されているテキサス・インスツルメンツ製品を使用するアプリケーションの開発の目的でのみ、テキサス・インスツルメンツはその使用をお客様に許諾します。これらのリソースに関して、他の目的で複製することや掲載することは禁止されています。テキサス・インスツルメンツや第三者の知的財産権のライセンスが付与されている訳ではありません。お客様は、これらのリソースを自身で使用した結果発生するあらゆる申し立て、損害、費用、損失、責任について、テキサス・インスツルメンツおよびその代理人を完全に補償するものとし、テキサス・インスツルメンツは一切の責任を拒否します。

テキサス・インスツルメンツの製品は、[テキサス・インスツルメンツの販売条件](#)、または [ti.com](https://www.ti.com) やかかるテキサス・インスツルメンツ製品の関連資料などのいずれかを通じて提供する適用可能な条項の下で提供されています。テキサス・インスツルメンツがこれらのリソースを提供することは、適用されるテキサス・インスツルメンツの保証または他の保証の放棄の拡大や変更を意味するものではありません。

お客様がいかなる追加条項または代替条項を提案した場合でも、テキサス・インスツルメンツはそれらに異議を唱え、拒否します。

郵送先住所：Texas Instruments, Post Office Box 655303, Dallas, Texas 75265  
Copyright © 2025, Texas Instruments Incorporated