

TPS62903, 3-V to 17-V, High Efficiency and Low I_Q Buck Converter in 1.5-mm × 2-mm QFN Package

1 Features

- High efficiency for wide duty cycle and load range
 - I_Q : 4- μ A typical
 - Selectable switching frequency: 2.5 MHz and 1.0 MHz
 - $R_{DS(ON)}$: 62-m Ω high side, 22-m Ω low side
 - Automatic efficiency enhancement (AEE)
- Small 1.5-mm × 2.0-mm VQFN package with 0.5-mm pitch
- Up to 3-A continuous output current
- $\pm 0.9\%$ feedback voltage accuracy across temp (-40°C to 150°C)
- Configurable output voltage options:
 - V_{FB} external divider: 0.6 V to 5.5 V
 - V_{SET} internal divider: 16 options between 0.4 V and 5.5 V
- DCS-Control™ topology with 100% mode
- Highly flexible and easy to use
 - Optimized pinout for single-layer routing
 - Precise enable input
 - Forced PWM or auto power save mode
 - Power good output
 - Selectable active output discharge
 - Adjustable soft start and tracking
- No external bootstrap capacitor required
- Create a custom design using the TPS62903 using the [WEBENCH® Power Designer](#)

2 Applications

- [Factory automation and control](#)
- [Building automation](#)
- [Data center and enterprise computing](#)

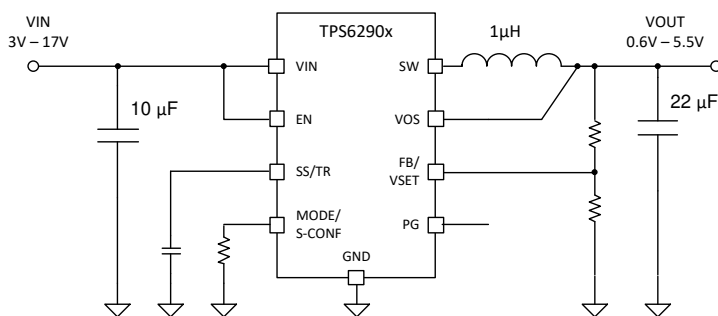

Simplified Schematic

- [Motor drives systems](#)
- [Power delivery](#)
- [PC and notebooks](#)

3 Description

The TPS62903 is a highly-efficient, small, and flexible synchronous step-down DC-DC converter that is easy to use. A selectable switching frequency of 2.5 MHz or 1.0 MHz allows the use of small inductors and provides fast transient response. The device supports high V_{OUT} accuracy of $\pm 1\%$ with the DCS-Control topology. The wide input voltage range of 3 V to 17 V supports a variety of nominal inputs, like 12-V supply rails, single-cell or multi-cell Li-Ion, and 5-V or 3.3-V rails.

The TPS62903 can automatically enter power save mode (if auto PFM/PWM is selected) at light loads to maintain high efficiency. Additionally, to provide high efficiency at very small loads, the device has a low typical quiescent current of 4 μ A. AEE, if enabled, provides high efficiency across V_{IN} , V_{OUT} , and load current. The device includes a MODE/Smart-CONF input to set the internal/external divider, switching frequency, output voltage discharge, and automatic power save mode or forced PWM operation.

The device is available in small 9-pin VQFN package measuring 1.50 mm × 2.00 mm with 0.5-mm pitch.

Device Information

PART NUMBER	PACKAGE ⁽¹⁾	BODY SIZE (NOM)
TPS62903	VQFN-HR	1.50 mm × 2.00 mm

- (1) For all available packages, see the orderable addendum at the end of the data sheet.

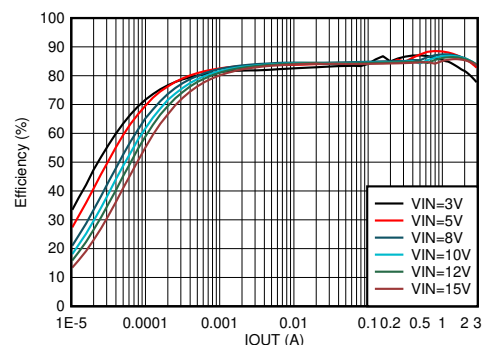

Efficiency Versus Output Current (1.2- V_O at 2.5 MHz-1 μ H, Auto PFM/PWM)



Table of Contents

1 Features	1	8 Application and Implementation	17
2 Applications	1	8.1 Application Information.....	17
3 Description	1	8.2 Typical Application with Adjustable Output Voltage..	17
4 Revision History	2	8.3 System Examples.....	37
5 Pin Configuration and Functions	3	9 Power Supply Recommendations	39
6 Specifications	4	10 Layout	40
6.1 Absolute Maximum Ratings	4	10.1 Layout Guidelines.....	40
6.2 ESD Ratings	4	10.2 Layout Example.....	40
6.3 Recommended Operating Conditions	4	11 Device and Documentation Support	42
6.4 Thermal Information	5	11.1 Device Support.....	42
6.5 Electrical Characteristics	5	11.2 Receiving Notification of Documentation Updates..	42
6.6 Typical Characteristics.....	7	11.3 Support Resources.....	42
7 Detailed Description	8	11.5 Electrostatic Discharge Caution.....	42
7.1 Overview.....	8	11.6 Glossary.....	42
7.2 Functional Block Diagram.....	8	12 Mechanical, Packaging, and Orderable Information	42
7.3 Feature Description.....	9		
7.4 Device Functional Modes.....	14		

4 Revision History

NOTE: Page numbers for previous revisions may differ from page numbers in the current version.

Changes from Revision * (February 2021) to Revision A (March 2021)	Page
• Changed device status from Advance Information to Production Data.....	1

5 Pin Configuration and Functions

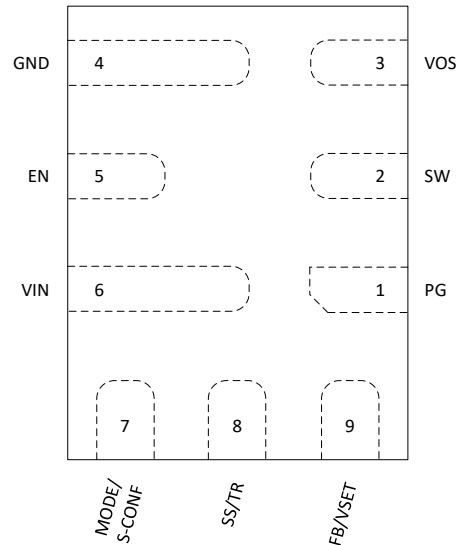

Figure 5-1. 9-Pin RPJ VQFN Package (Top View, Device Pins Face Down)

Table 5-1. Pin Functions

PIN		I/O	DESCRIPTION
NUMBER	NAME		
1	PG	O	Open-drain power good output. High = V_{OUT} is ready. Low = V_{OUT} is below nominal regulation. This pin requires a pullup resistor.
2	SW		Switch pin of the converter and is connected to the internal power switches. Connect the inductor between SW and the output capacitor.
3	VOS	I	Output voltage sense pin. Connect directly to the positive pin of the output capacitor.
4	GND		Ground pin. It must be connected directly to the common ground plane.
5	EN	I	Enable input pin. Connect to logic low to disable the device. Pull high to enable the device. Do not leave this pin unconnected.
6	VIN	I	Power supply input pin. Make sure the input capacitor is connected as close as possible between the VIN and GND pins.
7	MODE/ S-CONF	I	Device mode selection (auto PFM/PWM or forced PWM operation) and SmartConfig™ pin. Connect high, low, or to a resistor to configure the device according to Table 7-1 . Do not leave this pin unconnected.
8	SS/TR	I	Soft Start/Tracking pin. An external capacitor connected from this pin to GND defines the rise time for the internal reference voltage. The pin can also be used as an input for tracking and sequencing. The pin can be left floating for the fastest ramp-up time.
9	FB/ VSET	I	Depends on device configuration (see Section 7.3.1) <ul style="list-style-type: none"> • FB: Voltage feedback input. Connect resistive output voltage divider to this pin. • VSET: Output voltage setting pin. Connect a resistor to GND to choose the output voltage according to Table 7-2.

6 Specifications

6.1 Absolute Maximum Ratings

over operating temperature range (unless otherwise noted)⁽¹⁾

		MIN	MAX	UNIT
Voltage ⁽²⁾	VIN, EN, PG, MODE/S-CONF	-0.3	18	V
	SW (DC)	-0.3	V _{IN} + 0.3	
	SW (AC, less than 10ns) ⁽³⁾	-3.0	23	
	FB/VSET, SS/TR, VOS	-0.3	6	
T _J	Junction temperature	-40	150	°C
T _{stg}	Storage temperature	-65	150	°C

- (1) Operation outside the *Absolute Maximum Ratings* may cause permanent device damage. *Absolute Maximum Ratings* do not imply functional operation of the device at these or any other conditions beyond those listed under *Recommended Operating Conditions*. If used outside the *Recommended Operating Conditions* but within the *Absolute Maximum Ratings*, the device may not be fully functional, and this may affect device reliability, functionality, performance, and shorten the device lifetime.
- (2) All voltage values are with respect to network ground terminal.
- (3) While switching.

6.2 ESD Ratings

			VALUE	UNIT
V _(ESD)	Electrostatic discharge	Human body model (HBM), per ANSI/ESDA/ JEDEC JS-001, all pins ⁽¹⁾	±2000	V
		Charged device model (CDM), per JEDEC specification JESD22-C101, all pins ⁽²⁾	±500	

- (1) JEDEC document JEP155 states that 500-V HBM allows safe manufacturing with a standard ESD control process.
- (2) JEDEC document JEP157 states that 250-V CDM allows safe manufacturing with a standard ESD control process.

6.3 Recommended Operating Conditions

Over operating junction temperature range (unless otherwise noted)

		MIN	NOM	MAX	UNIT
V _I	Input voltage range	3.0		17	V
V _O	Output voltage range	0.4		5.5	V
C _I	Effective input capacitance	3	10		µF
C _O	Effective output capacitance (2.5MHz selection)	10	22	100 ⁽¹⁾	µF
C _O	Effective output capacitance (1.0MHz selection)	6	22	50 ⁽¹⁾	µF
I _{OUT}	Output current	0		3	A
I _{SINK_PG}	Sink current at PG-Pin			1	mA
T _J	Junction temperature ⁽²⁾	-40		150	°C

- (1) This is for capacitors directly at the output of the device. More capacitance is allowed if there is a series resistance associated to the capacitor.
- (2) Operating lifetime is derated at junction temperatures greater than 125°C.

6.4 Thermal Information

THERMAL METRIC ⁽¹⁾		TPS6290x		UNIT
		VQFN 9-Pin		
		JEDEC PCB	TPS6290xEVM-069	
R _{θJA}	Junction-to-ambient thermal resistance	97.2	73.5	°C/W
R _{θJC(top)}	Junction-to-case (top) thermal resistance	74.4	N/A	°C/W
R _{θJB}	Junction-to-board thermal resistance	25	N/A	°C/W
Ψ _{JT}	Junction-to-top characterization parameter	2.7	4.3	°C/W
Ψ _{JB}	Junction-to-board characterization parameter	24.7	28	°C/W

(1) For more information about traditional and new thermal metrics, see the [Semiconductor and IC Package Thermal Metrics](#) application report.

6.5 Electrical Characteristics

V_I = 3 V to 17 V, T_J = -40°C to +150°C, Typical values at V_I = 12.0 V and T_A = 25°C, unless otherwise noted

PARAMETER		TEST CONDITIONS	MIN	TYP	MAX	UNIT
SUPPLY						
I _{Q_PSM}	Operating Quiescent Current (Power Save Mode)	I _{out} = 0 mA, device not switching		4		μA
I _{Q_PWM}	Operating Quiescent Current (PWM Mode)	V _{IN} =12 V, V _{OUT} =1.2 V; I _{out} = 0 mA, device switching		8		mA
I _{SD}	Shutdown current into VIN pin	EN = 0 V		0.27	3.5	μA
V _{UVLO}	Under Voltage Lock-Out	V _{IN} rising	2.85	2.925	3.0	V
	Under Voltage Lock-Out	V _{IN} falling	2.7	2.775	2.85	V
V _{UVLO_HYS}	Under Voltage Lock-Out Hysteresis	Hysteresis		150		mV
CONTROL & INTERFACE						
I _{LKG}	EN Input leakage current	EN = 12 V		10	300	nA
V _{IH_MODE}	High-Level Input Voltage at MODE/S-CONF-Pin		1.0			V
T _{SD}	Thermal Shutdown Threshold	T _J rising		170		°C
	Thermal Shutdown Hysteresis	Hysteresis		20		
V _{IH}	High-level input voltage at EN-Pin		0.97	1.0	1.03	V
V _{IL}	Low-level input voltage at EN-Pin		0.87	0.9	0.93	V
R _{EN_PD}	Smart-Enable Internal Pulldown Resistor	EN = LOW		0.5		MΩ
V _{PG}	Power good threshold	V _{FB} rising, referenced to V _{FB} nominal	93.5%	96%	99%	
		V _{FB} falling, referenced to V _{FB} nominal	88.5%	93%	96%	
		Hysteresis	1.5%	3.5%	6%	
V _{PG_OL}	Low-level output voltage at PG pin	I _{SINK} = 1 mA			0.4	V
I _{PG_LKG}	Input leakage current into PG pin	V _{PG} = 5 V		15	550	nA
t _{PG_DLY}	Power good delay time	V _{FB} falling		32		μs
R _{SET}	S-CONF/VSET Resistor Tolerance		-4		+4	%
C _{SET}	Maximum Capacitance connected to S-CONF/VSET Pins				30	pF
POWER SWITCHES						
I _{LKG_SW}	Leakage current into SW-Pin	V _{SW} = V _{OS} = 5.5 V		2	7	μA
R _{DS_ON}	High-side FET on resistance	V _{IN} > 4 V, I _{SW} = 500 mA		62	111	mΩ
	Low-side FET on resistance	V _{IN} > 4 V, I _{SW} = 500 mA		22	40	
I _{LIM}	High-side FET current limit	TPS62903	4.0	4.6	5.5	A
	Low-side FET current limit	TPS62903	4.0	4.4	5.0	A

TPS62903

SLVSES3A – FEBRUARY 2021 – REVISED MARCH 2021

 $V_I = 3\text{ V to }17\text{ V}$, $T_J = -40^\circ\text{C to }+150^\circ\text{C}$, Typical values at $V_I = 12.0\text{ V}$ and $T_A = 25^\circ\text{C}$, unless otherwise noted

PARAMETER		TEST CONDITIONS	MIN	TYP	MAX	UNIT
I_{LIM_SINK}	Low-side FET sink current limit		1.3	1.7	2.5	A
f_{SW}	Switching frequency	2.5-MHz selection		2.5		MHz
$T_{ON(MIN)}$	Minimum On-time			50		ns
f_{SW}	Switching frequency	1.0-MHz selection		1.0		MHz
D	Dutycycle				1	
OUTPUT						
V_{O_Reg1}	Output Voltage Regulation	VSET Configuration selected. $T_J = 25^\circ\text{C}$.	-0.9%		+0.9%	
V_{O_Reg2}	Output Voltage Regulation	VSET Configuration selected. $0^\circ\text{C} < T_J < 85^\circ\text{C}$	-1.1%		+1.1%	
V_{O_Reg3}	Output Voltage Regulation	VSET Configuration selected. $-40^\circ\text{C} < T_J < 150^\circ\text{C}$	-1.25%		+1.25%	
V_{FB}	Feedback Regulation Voltage	Adjustable Configuration selected		0.6		V
V_{FB_Reg1}	Feedback Voltage Regulation	FB-Option selected. $T_J = 25^\circ\text{C}$.	-0.6%		+0.6%	
V_{FB_Reg2}	Feedback Voltage Regulation	FB-Option selected. $0^\circ\text{C} < T_J < 85^\circ\text{C}$.	-0.65%		+0.65%	
V_{FB_Reg3}	Feedback Voltage Regulation	FB-Option selected. $-40^\circ\text{C} < T_J < 150^\circ\text{C}$	-0.9%		+0.9%	
I_{FB}	Input leakage current into FB pin	Adjustable configuration, $V_{FB} = 0.6\text{ V}$		1	70	nA
T_{delay}	Start-up delay time	$I_O = 0\text{ mA}$, time from EN=HIGH until start switching, Adjustable Configuration selected		600	1400	μs
	Start-up delay time	$I_O = 0\text{ mA}$, time from EN=HIGH until start switching, VSET Configuration selected. The typical value is based on the first option of VSET configuration.		650	1850	μs
T_{SS}	Soft-Start time	$I_O = 0\text{ mA}$ after T_{delay} , from 1 st switching pulse until target V_O ; TR/SS-Pin = OPEN		150	200	μs
I_{SS}	SS/TR source current		2.3	2.5	2.7	μA
$V_{FB}/V_{SS/TR}$	Tracking Gain, Adjustable Configuration			0.75		
$V_{FB}/V_{SS/TR}$	Tracking Gain tolerance			± 8		mV
R_{DISCH}	Active Discharge Resistance	Discharge = ON - Option Selected, EN = LOW,		7.5	20	Ω

6.6 Typical Characteristics

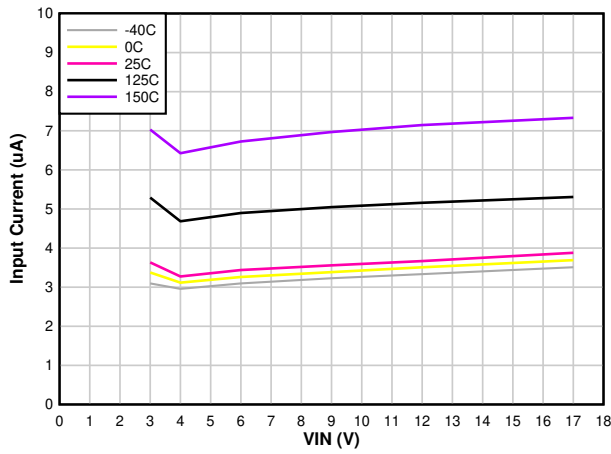

Figure 6-1. Typical Quiescent Current vs V_{IN}

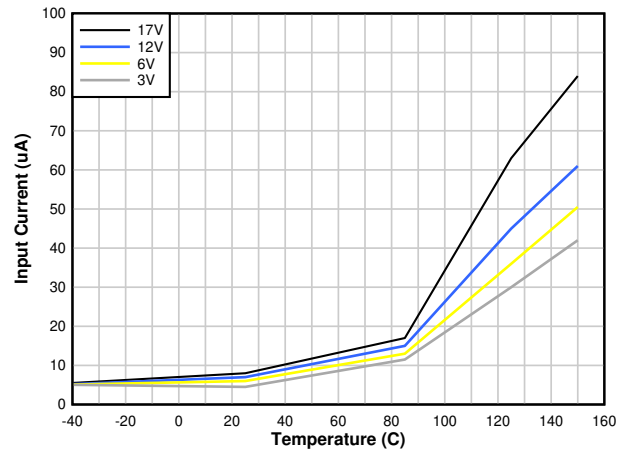

Figure 6-2. Maximum Quiescent Current vs Temperature

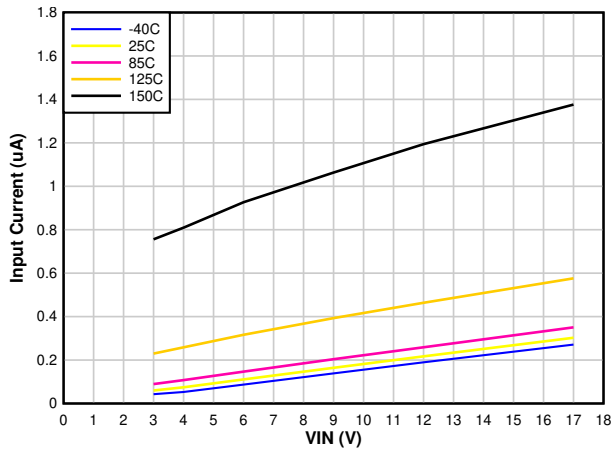

Figure 6-3. Typical Shutdown Current

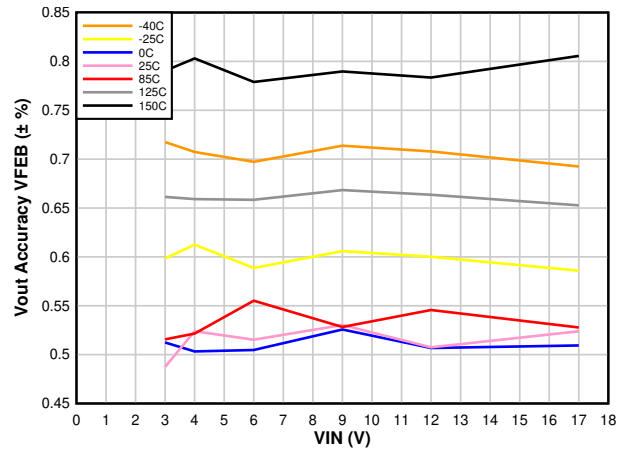

Figure 6-4. Output Voltage Accuracy - VFEB Selected

7 Detailed Description

7.1 Overview

The TPS62903 synchronous switched mode power converters are based on DCS-Control (Direct Control with Seamless Transition into power save mode). DCS-Control is an advanced regulation topology that combines the advantages of hysteretic, voltage mode, and current mode control. This control loop takes information about output voltage changes and feeds it directly to a fast comparator stage. It sets the switching frequency, which is constant for steady-state operating conditions, and provides immediate response to dynamic load changes. To get accurate DC load regulation, a voltage feedback loop is used. The internally-compensated regulation network achieves fast and stable operation with small external components and low-ESR capacitors.

7.2 Functional Block Diagram

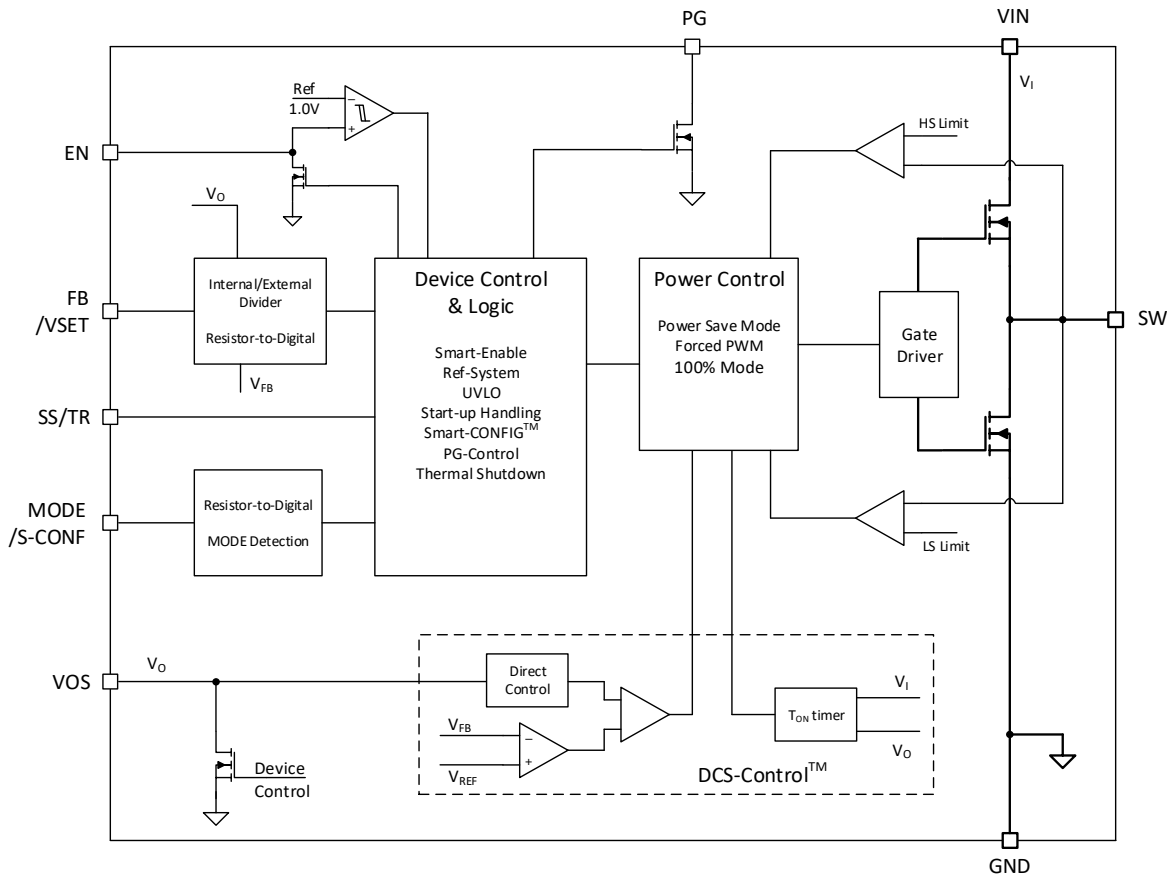

7.3 Feature Description

7.3.1 Mode Selection and Device Configuration MODE/S-CONF

With MODE/S-CONF (SmartConfig), this device features an input with two functions. It can be used to customize the device behavior in two ways:

- Select the device mode (FPWM or auto PFM/PWM with AEE operation) traditionally with a HIGH- or LOW-level.
- Select the device configuration (switching frequency, internal/external feedback, output discharge, and PFM/PWM mode) by connecting a single resistor to the MODE/S-CONF pin.

The device interprets this pin during the start-up sequence after the internal OTP readout and before it starts switching in soft start. If the device reads a HIGH- or LOW-level, the Dynamic Mode Change is active and PFM/PWM mode can be changed during operation. If the device reads a resistor value, there is no further interpretation during operation and device mode or other configurations cannot be changed afterwards.

Note

The MODE/S-CONF pin must not be left floating. Connect the pin high, low, or to a resistor to configure the device according to [Table 7-1](#).

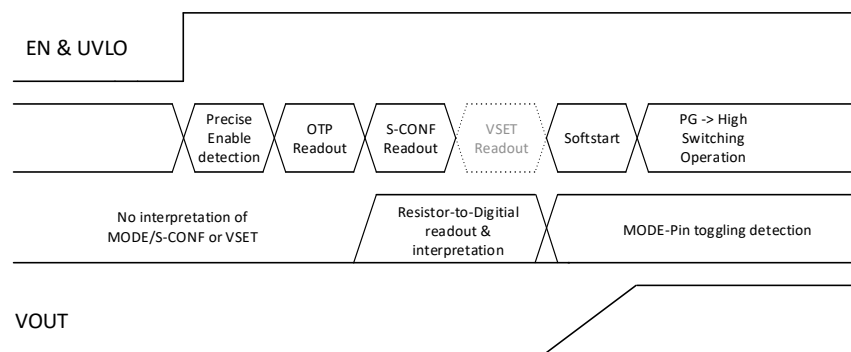

Figure 7-1. Interpretation of S-CONF and VSET Flow

Table 7-1. SmartConfig Setting Table

#	LEVEL OR RESISTOR VALUE [Ω] ⁽¹⁾	FB/VSET-PIN	F _{sw} (MHz)	OUTPUT DISCHARGE	MODE (AUTO OR FORCED PWM)	DYNAMIC MODE CHANGE
Setting Options by Level						
1	GND	external FB	2.5	yes	Auto PFM/PWM with AEE	active
2	HIGH (>V _{IH_MODE})	external FB	2.5	yes	Forced PWM	
Setting Options by Resistor						
3	7.15 k	external FB	2.5	no	Auto PFM/PWM with AEE	not active
4	8.87 k	external FB	2.5	no	Forced PWM	
5	11.0 k	external FB	1	yes	Auto PFM/PWM	
6	13.7 k	external FB	1	yes	Forced PWM	
7	16.9 k	external FB	1	no	Auto PFM/PWM	
8	21.0 k	external FB	1	no	Forced PWM	
9	26.1 k	VSET	2.5	yes	Auto PFM/PWM with AEE	
10	32.4 k	VSET	2.5	yes	Forced PWM	
11	40.2 k	VSET	2.5	no	Auto PFM/PWM with AEE	
12	49.9 k	VSET	2.5	no	Forced PWM	
13	61.9 k	VSET	1	yes	Auto PFM/PWM	
14	76.8 k	VSET	1	yes	Forced PWM	
15	95.3 k	VSET	1	no	Auto PFM/PWM	
16	118 k	VSET	1	no	Forced PWM	

(1) E96 Resistor Series, 1% Accuracy, Temperature Coefficient better or equal than ±200 ppm/°C

7.3.2 Adjustable V_O Operation (External Voltage Divider)

The TPS62903 can be programmed by the MODE/S-CONF pin to either classical configuration where the FB/VSET pin is used as the feedback pin, sensing V_O through an external resistive divider. The TPS62903 can also be programmed to 16 different fixed output voltages. These are set through an external resistor between the FB/VSET pin and GND. In this configuration, V_O is directly sensed at the VOS terminal of the device.

If the device is configured to operate in classical adjustable V_O operation, the FB/VSET pin is used as the feedback pin and needs to sense V_O through an external divider network. [Figure 7-2](#) shows the typical schematic for this configuration.

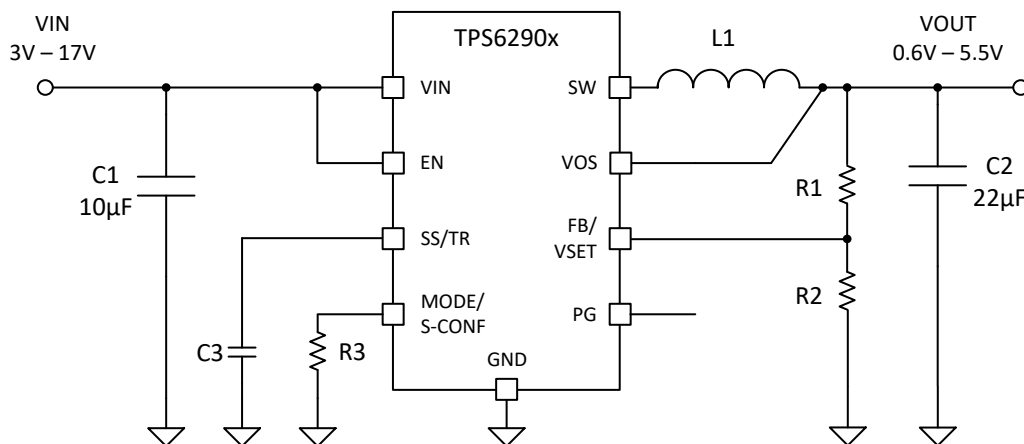
**Figure 7-2. Adjustable V_O Operation Schematic**

7.3.3 Setable V_O Operation (VSET and Internal Voltage Divider)

If the device is configured to VSET-operation, V_O is sensed only through the VOS pin by an internal resistor divider. The target V_O is programmed by an external resistor connected between the VSET pin and GND. Figure 7-3 shows the typical schematic for this configuration.

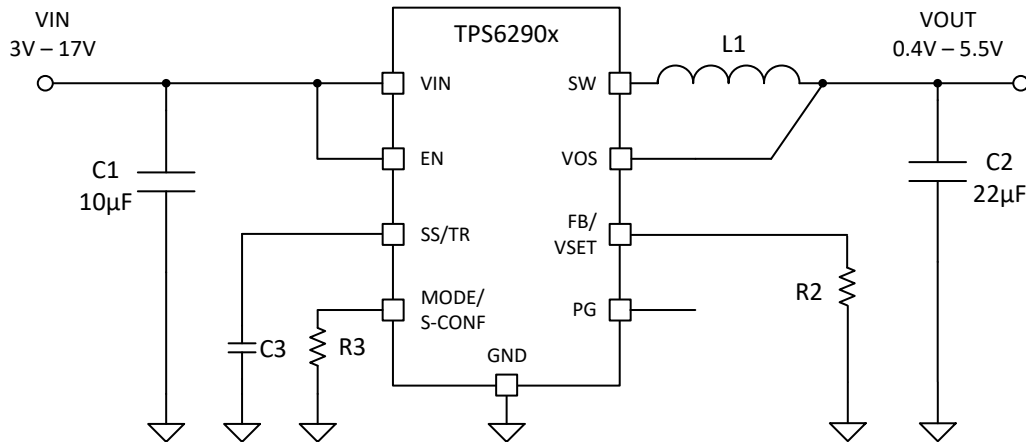

Figure 7-3. Setable V_O Operation Schematic

Table 7-2. VSET Selection Table

#	RESISTOR VALUE [Ω]	TARGET V_O [V]
1	GND	1.2
2	4.64 k	0.4
3	5.76 k	0.6
4	7.15 k	0.8
5	8.87 k	1.0
6	11.0 k	1.1
7	13.7 k	1.3
8	16.9 k	1.35
9	21.0 k	1.8
10	26.1 k	1.9
11	40.2 k	2.5
12	61.9 k	3.8
13	76.8 k	5.0
14	95.3 k	5.1
15	118.0 k	5.5
16	249.00 k or larger/Open	3.3

7.3.4 Soft Start / Tracking (SS/TR)

With the SS/TR pin, it is possible to adjust the soft start behavior and track an external voltage. See Section 8.2.2.6 for operation details.

The internal soft-start circuitry controls the output voltage slope during start-up. This avoids excessive inrush current and ensures a controlled output voltage rise time. It also prevents unwanted voltage drops from high impedance power sources or batteries. When EN is set high to start operation, the device starts switching after a delay, then the internal reference, and hence V_O , rises with a slope controlled by an external capacitor connected to the SS/TR pin.

Leaving the SS/TR pin unconnected provides the fastest start-up, limited internally (the pin must not be pulled LOW externally).

If the device is set to shut down (EN = GND), undervoltage lockout, or thermal shutdown, an internal resistor pulls the SS/TR pin down to ensure a proper low level. Returning from those states causes a new start-up sequence as set by the SS/TR connection.

A voltage supplied to SS/TR can be used to track a master voltage. The output voltage follows this voltage up and down in forced PWM mode. In PFM mode, the output voltage decreases based on the load current.

7.3.5 Smart Enable with Precise Threshold

The voltage applied at the enable pin of the TPS62903 is compared to a fixed threshold rising voltage. This allows you to drive the pin by a slowly changing voltage and enables the use of an external RC network to achieve a power-up delay.

The precise enable input allows the user to program the undervoltage lockout by adding a resistor divider to the input of the enable pin.

The enable input threshold for a falling edge is lower than the rising edge threshold. The TPS62903 starts operation when the rising threshold is exceeded. For proper operation, the EN pin must be terminated and must not be left floating. Pulling the EN pin low forces the device into shutdown. In this mode, the internal high-side and low-side MOSFETs are turned off and the entire internal control circuitry is switched off.

An internal resistor pulls the EN pin to GND when the device is disabled and avoids the pin to be float (once the device is enabled, the pulldown is removed). This prevents an uncontrolled start-up of the device in case the EN pin cannot be driven to a low level safely. With EN low, the device is in shutdown mode. The device is turned on with EN set to a high level. The pulldown control circuit disconnects the pulldown resistor on the EN pin once the internal control logic and the reference have been powered up. With EN set to a low level, the device enters shutdown mode and the pulldown resistor is activated again.

7.3.6 Power Good (PG)

The TPS62903 has a built-in Power Good (PG) feature to indicate whether the output voltage has reached its target and the device is ready. The PG signal can be used for start-up sequencing of multiple rails. The PG pin is an open-drain output that requires a pullup resistor to any voltage up to the recommended input voltage level. PG is low when the device is turned off due to EN, UVLO (undervoltage lockout), or thermal shutdown. V_{IN} must remain present for the PG pin to stay low.

If the power good output is not used, it is recommended to tie to GND or leave it open.

Table 7-3. Power Good Indicator Functional Table

LOGIC SIGNALS				PG STATUS
V_I	EN-PIN	THERMAL SHUTDOWN	V_O	
$V_I > UVLO$	HIGH	No	V_O on target	High Impedance
			$V_O < target$	LOW
		Yes	x	LOW
	LOW	x	x	LOW
$1.8 V < V_I < UVLO$	x	x	x	LOW
$V_I < 1.8 V$	x	x	x	Undefined

7.3.7 Undervoltage Lockout (UVLO)

If the input voltage drops, the undervoltage lockout prevents mis-operation of the device by switching off both the power FETs. The device is fully operational for voltages above the rising UVLO threshold and turns off if the input voltage trips below the threshold for a falling supply voltage.

7.3.8 Current Limit And Short Circuit Protection

The TPS62903 is protected against overload and short circuit events. If the inductor current exceeds the high-side FET current limit (I_{LIMH}), the high-side switch is turned off and the low-side switch is turned on to ramp down the inductor current. The high-side FET turns on again only if the current in the low-side FET has decreased below the low-side FET current limit threshold.

Due to internal propagation delay, the actual current can exceed the static current limit during that time. The dynamic current limit is given as [Equation 1](#):

$$I_{peak(typ)} = I_{LIMH} + \frac{V_L}{L} \times t_{PD} \quad (1)$$

where

- I_{LIMH} is the static high-side FET current limit as specified in the [Electrical Characteristics](#)
- L is the effective inductance at the peak current
- V_L is the voltage across the inductor ($V_{IN} - V_{OUT}$)
- t_{PD} is the internal propagation delay of typically 50 ns

The current limit can exceed static values, especially if the input voltage is high and very small inductances are used. The dynamic high-side switch peak current can be calculated as follows:

$$I_{peak(typ)} = I_{LIMH} + \frac{V_{IN} - V_{OUT}}{L} \times 50 \text{ ns} \quad (2)$$

7.3.9 Thermal Shutdown

The junction temperature, T_J , of the device is monitored by an internal temperature sensor. If T_J rises and exceeds the thermal shutdown threshold, T_{SD} , the device shuts down. Both the high-side and low-side power FETs are turned off and PG goes low. When T_J decreases below the hysteresis, the converter resumes normal operation, beginning with soft start. During a PFM skip pause, the thermal shutdown feature is not active. A shutdown or re-start is only triggered during a switching cycle. See [Section 7.4.3](#).

7.4 Device Functional Modes

7.4.1 Pulse Width Modulation (PWM) Operation

The TPS62903 has two operating modes: forced PWM mode discussed in this section and PWM/PFM as discussed in [Section 7.4.3](#).

With the MODE/S-CONF pin configured for PWM mode, the TPS62903 operates with pulse width modulation in continuous conduction mode (CCM) with a nominal switching frequency of 2.5/1.0 MHz. The frequency variation in PWM is controlled and depends on V_{IN} , V_{OUT} , and the inductance. The on-time in forced PWM mode is given by [Equation 3](#):

$$TON = \frac{V_{OUT}}{V_{IN}} \times \frac{1}{f_{sw}} \quad (3)$$

7.4.2 AEE (Automatic Efficiency Enhancement)

When the MODE/S-CONF pin is configured for AEE mode, the TPS62903 provides the highest efficiency over the entire input voltage and output voltage range by automatically adjusting the switching frequency of the converter. This is achieved by setting the predictive off-time of the converter. The efficiency of a switched mode converter is determined by the power losses during the conversion. The efficiency decreases if V_{OUT} decreases, V_{IN} increases as shown in [Equation 4](#), or both. In order to keep the efficiency high over the entire duty cycle range (V_{OUT}/V_{IN} ratio), the switching frequency is adjusted while maintaining the ripple current.

$$F_{sw} (MHz) = 10 \times V_{OUT} \times \frac{V_{IN} - V_{OUT}}{V_{IN}^2} \quad (4)$$

The AEE function in the TPS62903 adjusts the on-time (TON) in power save mode, depending on the input voltage and the output voltage to maintain highest efficiency. The on-time in steady-state operation can be estimated as using [Equation 5](#):

$$TON = 100 \times \frac{VIN}{VIN - VOUT} [ns] \quad (5)$$

[Equation 6](#) shows the relation among the inductor ripple current, switching frequency, and duty cycle.

$$\Delta I_L = V_{OUT} \times \left(\frac{1-D}{L \times f_{sw}} \right) = V_{OUT} \times \left(\frac{1 - \left(\frac{V_{OUT}}{V_{IN}} \right)}{L \times f_{sw}} \right) \quad (6)$$

Efficiency increases by decreasing switching losses and preserving high efficiency for varying duty cycles, while the ripple current amplitude remains low enough to deliver the full output current without reaching current limit. The AEE feature provides an efficiency enhancement for various duty cycles, especially for lower V_{OUT} values where fixed frequency converters suffer from a significant efficiency drop. Furthermore, this feature compensates for the very small duty cycles of high V_{IN} to low V_{OUT} conversion, which limits the control range in other topologies.

7.4.3 Power Save Mode Operation (Auto PFM/PWM)

When the MODE/S-CONF pin is configured for power save mode (auto PFM/PWM). The device operates in PWM mode as long the output current is higher than half of the ripple current of the inductor. To maintain high efficiency at light loads, the device enters power save mode at the boundary to discontinuous conduction mode (DCM). This happens if the output current becomes smaller than half of the ripple current of the inductor. The power save mode is entered seamlessly when the load current decreases. This ensures a high efficiency in light load operation. The device remains in power save mode as long as the inductor current is discontinuous.

In power save mode, the switching frequency decreases linearly with the load current maintaining high efficiency. The transition in and out of power save mode is seamless in both directions.

In addition to adjusting the switching, the TPS62903 adjusts the on-time (TON) in power save mode, depending on the input voltage and the output voltage to maintain highest efficiency using the AEE function when 2.5 MHz is selected as described in [Section 7.4.2](#).

In power save mode, the TON time can be estimated using [Equation 3](#) for 1 MHz and [Equation 5](#) for 2.5 MHz (given the AEE is enabled for 2.5 MHz).

For very small output voltages, an absolute minimum on-time of about 50 ns is kept to limit switching losses. The operating frequency is thereby reduced from its nominal value, which keeps efficiency high. Using TON, the typical peak inductor current in power save mode is approximated by [Equation 7](#):

$$ILPSM_{(peak)} = \frac{(V_{IN} - V_{OUT})}{L} \times TON \quad (7)$$

There is a minimum off-time which limits the duty cycle of the TPS62903. When V_{IN} decreases to typically 15% above V_{OUT} , the TPS62903 does not enter power save mode, regardless of the load current. The device maintains output regulation in PWM mode.

The output voltage ripple in power save mode is given by [Equation 8](#):

$$\Delta V = \frac{L \times V_{IN}^2}{200 \times C} \left(\frac{1}{V_{IN} - V_{OUT}} + \frac{1}{V_{OUT}} \right) \quad (8)$$

where

- L is the effective inductance
- C is the output effective capacitance

7.4.4 100% Duty-Cycle Operation

The duty cycle of the buck converter operating in PWM mode is given as $D = V_{OUT}/V_{IN}$. The duty cycle increases as the input voltage comes close to the output voltage and the off-time gets smaller. When the minimum off-time of typically 80 ns is reached, the TPS62903 scales down its switching frequency while it approaches 100% mode. In 100% mode, it keeps the high-side switch on continuously. The high-side switch stays turned on as long as the output voltage is below the internal set point. This allows the conversion of small input to output voltage differences (for example, getting longest operation time of battery-powered applications). In 100% duty cycle mode, the low-side FET is switched off.

The minimum input voltage to maintain output voltage regulation, depending on the load current and the output voltage level, can be calculated as:

$$V_{IN(min)} = V_{OUT} + I_{OUT}(R_{DS(on)} + R_L) \quad (9)$$

where

- I_{OUT} is the output current
- $R_{DS(on)}$ is the on-state resistance of the high-side FET
- R_L is the DC resistance of the inductor used

7.4.5 Output Discharge Function

The purpose of the discharge function is to ensure a defined down-ramp of the output voltage when the device is being disabled but also to keep the output voltage close to 0 V when the device is off. The output discharge feature is only active once TPS62903 has been enabled at least once since the supply voltage was applied.

The internal discharge resistor is connected to the VOS pin. The discharge function is enabled as soon as the device is disabled, in thermal shutdown, or in undervoltage lockout. The minimum supply voltage required for the discharge function to remain active typically is 2 V.

7.4.6 Starting into a Pre-Biased Load

The TPS62903 is capable of starting into a pre-biased output. The device only starts switching when the internal soft-start ramp is equal or higher than the feedback voltage. If the voltage at the feedback pin is biased to a higher voltage than the nominal value, the TPS62903 does not start switching unless the voltage at the feedback pin drops to the target.

8 Application and Implementation

Note

Information in the following applications sections is not part of the TI component specification, and TI does not warrant its accuracy or completeness. TI's customers are responsible for determining suitability of components for their purposes. Customers should validate and test their design implementation to confirm system functionality.

8.1 Application Information

The TPS62903 devices are highly-efficient, small, and highly-flexible synchronous step-down DC-DC converters that are easy to use. A wide input voltage range of 3 V to 17 V supports a wide variety of inputs like 12-V supply rails, single-cell or multi-cell Li-Ion, and 5-V or 3.3-V rails.

8.2 Typical Application with Adjustable Output Voltage

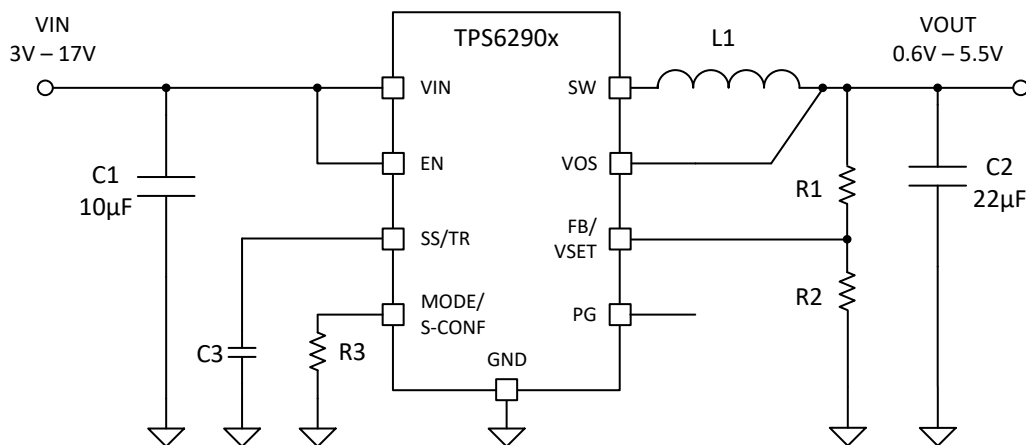

Figure 8-1. Typical Application Circuit

8.2.1 Design Requirements

Table 8-1. List of Components

REFERENCE	DESCRIPTION	MANUFACTURER
IC	17 V, 3-A Step-Down Converter	TPS6290x series; Texas Instruments
L	1-µH inductor	XGL4020-102; Coilcraft
CIN	10 µF, 25 V, Ceramic, 0805	C3216X7R1E106M160AE, TDK
COUT	22 µF, 16 V, Ceramic, 0805	C2012X7S1A226M125AC, TDK
CSS	Depends on soft start time; see Section 8.2.2.5.3	16 V, Ceramic, X7R
R1	Depending on V_{OUT} ; see Section 8.2.2.2	Standard 1% metal film
R2	Depending on V_{OUT} ; see Section 8.2.2.2	Standard 1% metal film
R3	Depending on device setting, see Section 7.3.1	Standard 1% metal film

8.2.2 Detailed Design Procedure

8.2.2.1 Custom Design With WEBENCH® Tools

[Click here](#) to create a custom design using the TPS62903 device with the WEBENCH® Power Designer.

1. Start by entering the input voltage (V_{IN}), output voltage (V_{OUT}), and output current (I_{OUT}) requirements.
2. Optimize the design for key parameters such as efficiency, footprint, and cost using the optimizer dial.
3. Compare the generated design with other possible solutions from Texas Instruments.

The WEBENCH Power Designer provides a customized schematic along with a list of materials with real-time pricing and component availability.

In most cases, these actions are available:

- Run electrical simulations to see important waveforms and circuit performance
- Run thermal simulations to understand board thermal performance
- Export customized schematic and layout into popular CAD formats
- Print PDF reports for the design, and share the design with colleagues

Get more information about WEBENCH tools at www.ti.com/WEBENCH.

8.2.2.2 Programming the Output Voltage

The output voltage of the TPS62903 is adjustable. It can be programmed for output voltages from 0.6 V to 5.5 V using a resistor divider from V_{OUT} to GND. The voltage at the FB pin is regulated to 600 mV. The value of the output voltage is set by the selection of the resistor divider from Equation 10. It is recommended to choose resistor values that allow a current of at least 2 μ A, meaning the value of R2 should not exceed 400 k Ω . Lower resistor values are recommended for highest accuracy and most robust design.

$$R_1 = R_2 \times \left(\frac{V_{OUT}}{V_{FB}} - 1 \right) \quad (10)$$

With typical $V_{FB} = 0.6$ V:

Table 8-2. Setting the Output Voltage

NOMINAL OUTPUT VOLTAGE	R1	R2	EXACT OUTPUT VOLTAGE
0.75 V	24.9 k Ω	100 k Ω	0.749 V
1.2 V	100 k Ω	100 k Ω	1.2 V
1.5 V	150 k Ω	100 k Ω	1.5 V
1.8 V	200 k Ω	100 k Ω	1.8 V
2.0 V	49.9 k Ω	21.5 k Ω	1.992 V
2.5 V	100 k Ω	31.6 k Ω	2.498 V
3.0 V	100 k Ω	24.9 k Ω	3.009 V
3.3 V	113 k Ω	24.9 k Ω	3.322 V
5.0V	182 k Ω	24.9 k Ω	4.985 V

8.2.2.3 External Component Selection

The external components have to fulfill the needs of the application, but also the stability criteria of the control loop of the device. The TPS62903 is optimized to work within a range of external components. The LC output filters inductance and capacitance have to be considered together, creating a double pole, responsible for the corner frequency of the converter (see Section 8.2.2.7). Table 8-3 can be used to simplify the output filter component selection. The values in Table 8-3 are nominal values. The effective capacitance was considered to vary by +20% and -50%.

Table 8-3. Recommended LC Output Filter Combinations

	4.7 μ F	10 μ F	22 μ F	47 μ F	100 μ F	200 μ F
1 μ H		√	√ ⁽¹⁾	√	√	√ ⁽³⁾
1.5 μ H		√	√	√	√ ⁽³⁾	
2.2 μ H		√	√ ⁽²⁾	√	√ ⁽³⁾	

(1) This LC combination is the standard value and recommended for most applications with 2.5 MHz switching frequency.

(2) This LC combination is the standard value and recommended for most applications with 1-MHz switching frequency.

(3) Output capacitance needs to have a ESR of ≥ 10 m Ω for stable operation, see Section 8.3.2.

8.2.2.4 Inductor Selection

The TPS62903 is designed for a nominal 1- μH inductor. Larger values can be used to achieve a lower inductor current ripple but they can have a negative impact on efficiency and transient response. Smaller values than 1 μH will cause a larger inductor current ripple which causes larger negative inductor current in forced PWM mode at low or no output current. Therefore, they are not recommended at large voltages across the inductor as it is the case for high input voltages and low output voltages. Low-output current in forced PWM mode causes a larger negative inductor current peak which can exceed the negative current limit. At low or no output current and small inductor values, the output voltage cannot be regulated any more. More detailed information on further LC combinations can be found in [SLVA463](#).

The inductor selection is affected by several factors like inductor ripple current, output ripple voltage, PWM-to-PFM transition point, and efficiency. In addition, the inductor selected has to be rated for appropriate saturation current and DC resistance (DCR). [Equation 11](#) calculates the maximum inductor current.

$$I_{L(\max)} = I_{OUT(\max)} + \frac{\Delta I_{L(\max)}}{2} \quad (11)$$

$$\Delta I_{L(\max)} = V_{OUT} \times \left(\frac{1 - \frac{V_{OUT}}{V_{IN(\max)}}}{L_{(\min)} \times f_{sw}} \right) \quad (12)$$

where

- $I_{L(\max)}$ is the maximum inductor current
- $\Delta I_{L(\max)}$ is the maximum peak-to-peak inductor ripple current
- $L_{(\min)}$ is the minimum effective inductor value
- f_{sw} is the the actual PWM switching frequency
- V_{OUT} is the output voltage
- $V_{IN(\max)}$ is the maximum expected output voltage

Calculating the maximum inductor current using the actual operating conditions gives the needed minimum saturation current of the inductor. It is recommended to add a margin of about 20%. A larger inductor value is also useful to get lower ripple current, but increases the transient response time and size as well. The following inductors have been used with the TPS62903 and are recommended for use:

Table 8-4. List of Inductors

TYPE	INDUCTANCE [μH]	CURRENT [A] ⁽¹⁾	DIMENSIONS [LxBxH] mm	MANUFACTURER
XGL4020-102ME	1.0 μH , $\pm 20\%$	8.8	4.0x4.0x2.1	Coilcraft
DFE252012F-1R0M	1.0 μH , $\pm 20\%$	4.7	2.5x2.5x1.2	muRata
CIGT252010TM1R0MLE	1.0 μH , $\pm 20\%$	5.3	2.5x2.5x1.0	Samsung
TFM252010ALM-1R0MTAA	1.0 μH , $\pm 20\%$	4.7	2.5x2.0x1.0	TDK
XEL5030-222ME	2.2 μH , $\pm 20\%$	9.7	5.3x5.5x3.1	Coilcraft
XGL4020-222ME	2.2 μH , $\pm 20\%$	6.2	4.0x4.0x2.1	Coilcraft

(1) I_{SAT} at 30% drop

The inductor value also determines the load current at which power save mode is entered:

$$I_{load(PSM)} = \frac{1}{2} \Delta I_L \quad (13)$$

8.2.2.5 Capacitor Selection

8.2.2.5.1 Output Capacitor

The recommended value for the output capacitor is 22 μF . The architecture of the TPS62903 allows the use of tiny ceramic output capacitors with low equivalent series resistance (ESR). These capacitors provide low output voltage ripple and are recommended. To keep its low resistance up to high frequencies and to get narrow capacitance variation with temperature, it is recommended to use X7R or X5R dielectric. Using a higher value has advantages like smaller voltage ripple and a tighter DC output accuracy in power save mode (see [SLVA463](#)).

In power save mode, the output voltage ripple depends on the output capacitance, its ESR, ESL, and the peak inductor current. Using ceramic capacitors provides small ESR, ESL, and low ripple. The output capacitor needs to be as close as possible to the device.

For large output voltages, the dc bias effect of ceramic capacitors is large and the effective capacitance has to be observed.

8.2.2.5.2 Input Capacitor

For most applications, 10 μF nominal is sufficient and is recommended, though a larger value reduces input current ripple further. The input capacitor buffers the input voltage for transient events and also decouples the converter from the supply. A low-ESR multilayer ceramic capacitor (MLCC) is recommended for best filtering and should be placed between VIN and GND as close as possible to those pins.

Table 8-5. List of Capacitors

TYPE ⁽¹⁾	NOMINAL CAPACITANCE [μF]	VOLTAGE RATING [V]	SIZE	MANUFACTURER
C3216X7R1E106K160AB	10	25	0805	TDK
C2012X7S1A226M125AC	22	10	0805	TDK

(1) Lower of I_{RMS} at 40°C rise or I_{SAT} at 30% drop.

8.2.2.5.3 Soft-Start Capacitor

A capacitor connected between SS/TR pin and GND allows a user-programmable start-up slope of the output voltage.

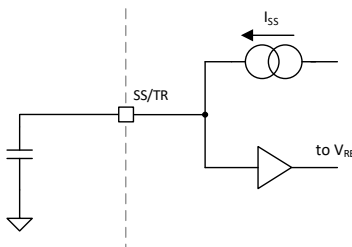

Figure 8-2. Soft-Start Operation Simplified Schematic

An internal constant current source is provided to charge the external capacitance. The capacitor required for a given soft-start ramp time is given by:

$$C_{SS} = T_{SS} \times \frac{I_{SS}}{V_{REF}} \quad (14)$$

where

- C_{SS} is the capacitance required at the SS/TR pin
- T_{SS} is the desired soft-start ramp time
- I_{SS} is the SS/TR source current, see the [Electrical Characteristics](#)
- V_{REF} is the feedback regulation voltage (V_{FB}), see the [Electrical Characteristics](#)

The fastest achievable typical ramp time is 150 μs even if the external C_{SS} capacitance is lower than 680 pF or the pin is open.

8.2.2.6 Tracking Function

If a tracking function is desired, the SS/TR pin can be used for this purpose by connecting it to an external tracking voltage. The output voltage tracks that voltage with the typical gain and offset as specified in the [Electrical Characteristics](#).

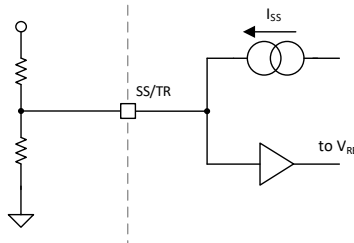

Figure 8-3. Tracking Operation Simplified Schematic

$$V_{FB} = 0.75 \times V_{SS/TR} \quad (15)$$

When the SS/TR pin voltage is above 0.8 V, the internal voltage is clamped and the device goes to normal regulation. This works for rising and falling tracking voltages with the same behavior, as long as the input voltage is inside the recommended operating conditions. For decreasing SS/TR pin voltage in PFM mode, the device does not sink current from the output. The resulting decrease of the output voltage can therefore be slower than the SS/TR pin voltage if the load is light. When driving the SS/TR pin with an external voltage, do not exceed the voltage rating of the SS/TR pin, which is 6 V. The SS/TR pin is internally connected with a resistor to GND when EN = 0.

If the input voltage drops below undervoltage lockout, the output voltage will go to zero, independent of the tracking voltage. [Figure 8-4](#) shows how to connect devices to get ratiometric and simultaneous sequencing by using the tracking function. See [Section 8.3.3](#) in the systems examples.

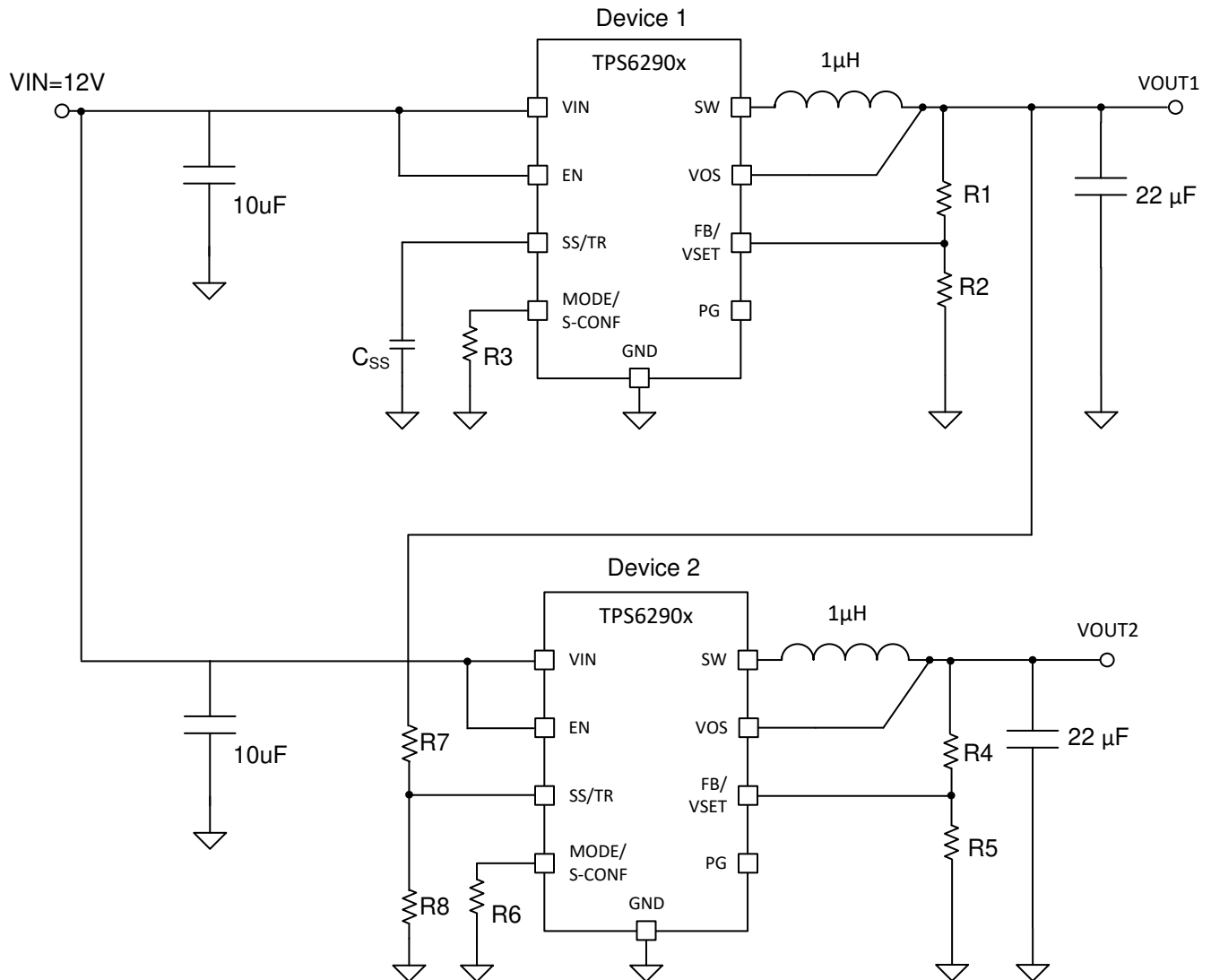

Figure 8-4. Schematic for Ratiometric and Simultaneous Start-up

The resistive divider of R7 and R8 can be used to change the ramp rate of VOUT2 to be faster, slower, or the same as VOUT1.

A sequential start-up is achieved by connecting the PG pin of VOUT of device 1 to the EN pin of device 2. PG requires a pullup resistor. Ratiometric start-up sequence happens if both supplies are sharing the same soft-start capacitor. Equation 14 gives the soft-start time, though the SS/TR current has to be doubled. Details about these and other tracking and sequencing circuits are found in SLVA470.

Note

If the voltage at the FB pin is below its typical value of 0.6 V, the output voltage accuracy can have a wider tolerance than specified. The current of 2.5 μ A out of the SS/TR pin also has an influence on the tracking function, especially for high resistive external voltage dividers on the SS/TR pin.

8.2.2.7 Output Filter and Loop Stability

The devices of the TPS62903 family are internally compensated to be stable with L-C filter combinations corresponding to a corner frequency to be calculated with Equation 16:

$$f_{LC} = \frac{1}{2\pi\sqrt{L \cdot C}} \quad (16)$$

Proven nominal values for inductance and ceramic capacitance are given in [Section 8.2.2.3](#) and are recommended for use. Different values can work, but care has to be taken on the loop stability which is affected. More information including a detailed LC stability matrix can be found in [SLVA463](#).

The TPS62903 devices include an internal 3-pF feedforward capacitor, connected between the VOS and FB pins. This capacitor impacts the frequency behavior and sets a pole and zero in the control loop with the resistors of the feedback divider, per [Equation 17](#) and [Equation 18](#):

$$f_{zero} = \frac{1}{2\pi \times R_1 \times 3pF} \quad (17)$$

$$f_{pole} = \frac{1}{2\pi \times 3pF} \times \left(\frac{1}{R_1} \times \frac{1}{R_2} \right) \quad (18)$$

Though the TPS62903 devices are stable without the pole and zero being in a particular location, adjusting their location to the specific needs of the application can provide better performance in power save mode, improved transient response, or both. An external feedforward capacitor can also be added. A more detailed discussion on the optimization for stability versus transient response can be found in [SLVA289](#) and [SLVA466](#).

8.2.3 Application Curves

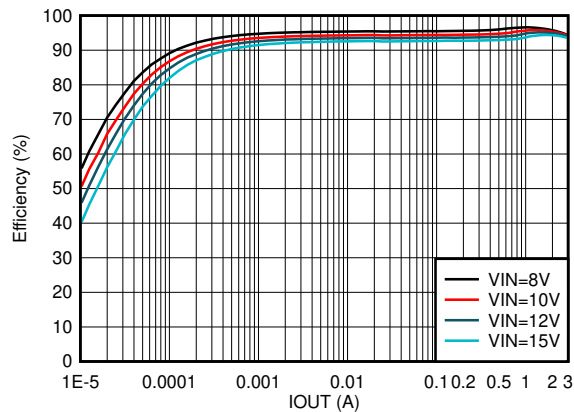

Auto PFM/PWM L = 2.2 μ H F_{sw} = 1 MHz

Figure 8-5. Efficiency vs Output Current V_{OUT} = 5 V

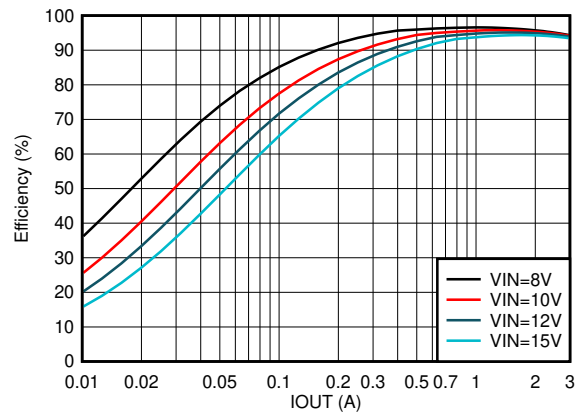

FPWM L = 2.2 μ H F_{sw} = 1 MHz

Figure 8-6. Efficiency vs Output Current V_{OUT} = 5 V

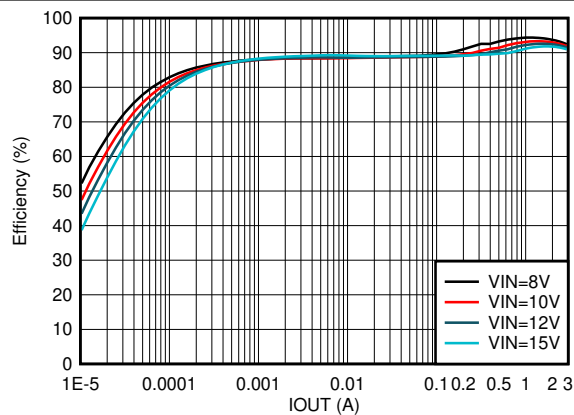

Auto PFM/PWM L = 1 μ H F_{sw} = 2.5 MHz

Figure 8-7. Efficiency vs Output Current V_{OUT} = 5 V

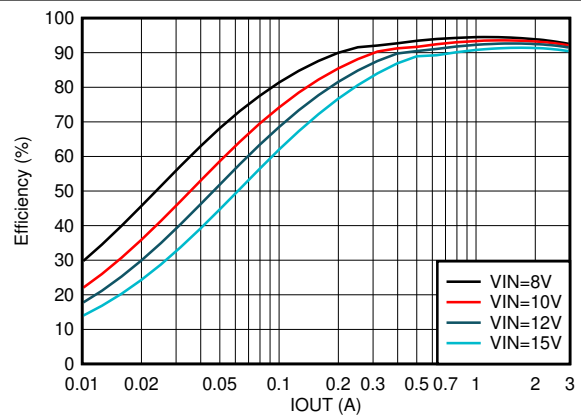

FPWM L = 1 μ H F_{sw} = 2.5 MHz

Figure 8-8. Efficiency vs Output Current V_{OUT} = 5 V

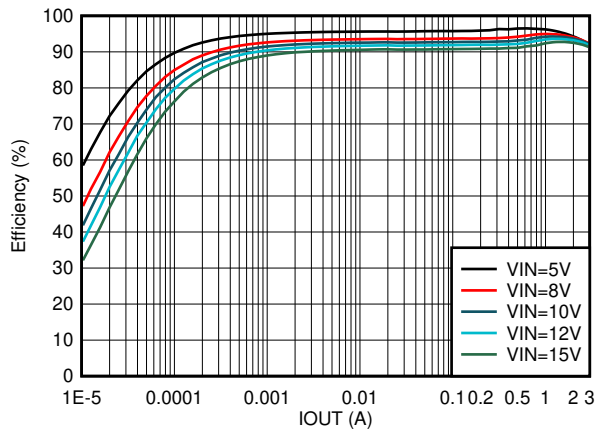

Auto PFM/PWM L = 2.2 μ H F_{sw} = 1 MHz

Figure 8-9. Efficiency vs Output Current V_{OUT} = 3.3 V

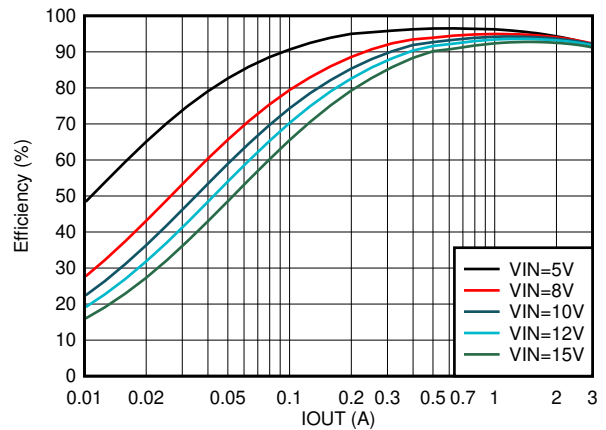

FPWM L = 2.2 μ H F_{sw} = 1 MHz

Figure 8-10. Efficiency vs Output Current V_{OUT} = 3.3 V

8.2.3 Application Curves (continued)

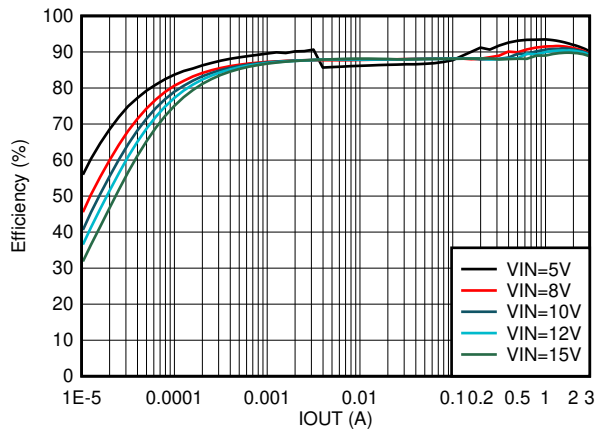

Auto PFM/PWM L = 1 µH F_{sw} = 2.5 MHz

Figure 8-11. Efficiency vs Output Current V_{OUT} = 3.3 V

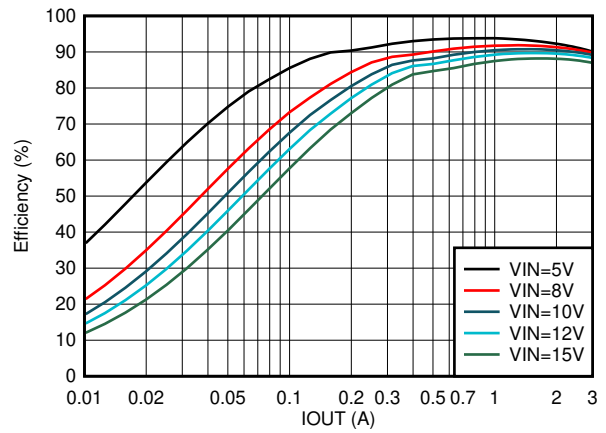

FPWM L = 1 µH F_{sw} = 2.5 MHz

Figure 8-12. Efficiency vs Output Current V_{OUT} = 3.3 V

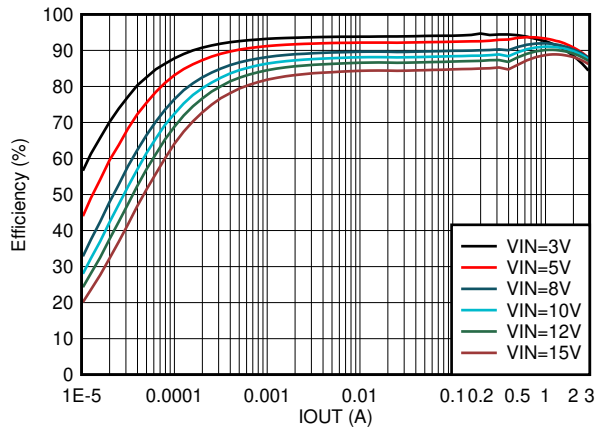

Auto PFM/PWM L = 2.2 µH F_{sw} = 1 MHz

Figure 8-13. Efficiency vs Output Current V_{OUT} = 1.8 V

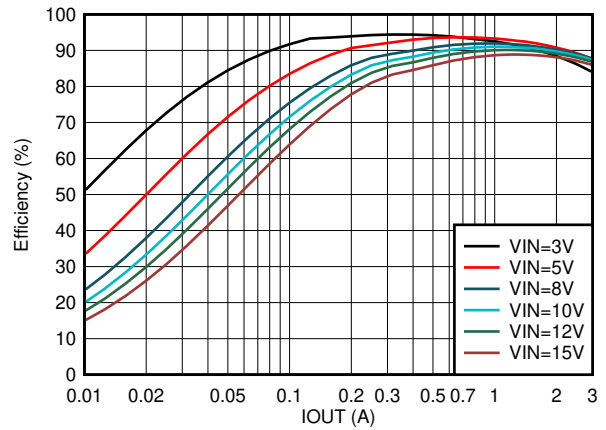

FPWM L = 2.2 µH F_{sw} = 1 MHz

Figure 8-14. Efficiency vs Output Current V_{OUT} = 1.8 V

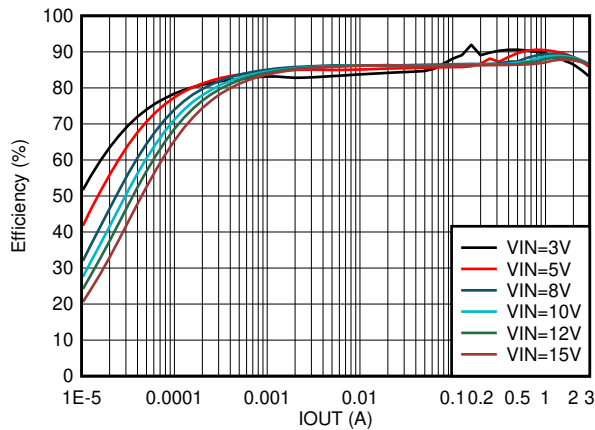

Auto PFM/PWM L = 1 µH F_{sw} = 2.5 MHz

Figure 8-15. Efficiency vs Output Current V_{OUT} = 1.8 V

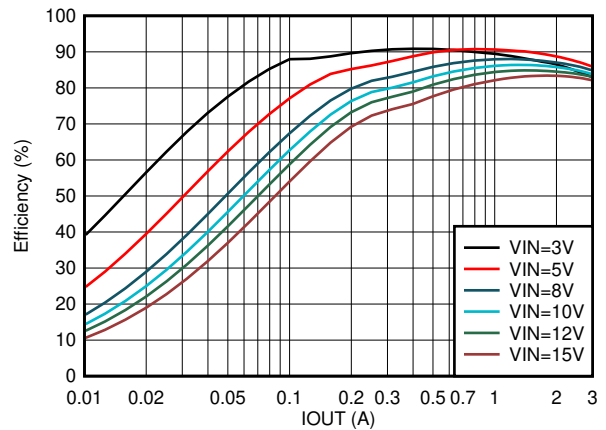

FPWM L = 1 µH F_{sw} = 2.5 MHz

Figure 8-16. Efficiency vs Output Current V_{OUT} = 1.8 V

8.2.3 Application Curves (continued)

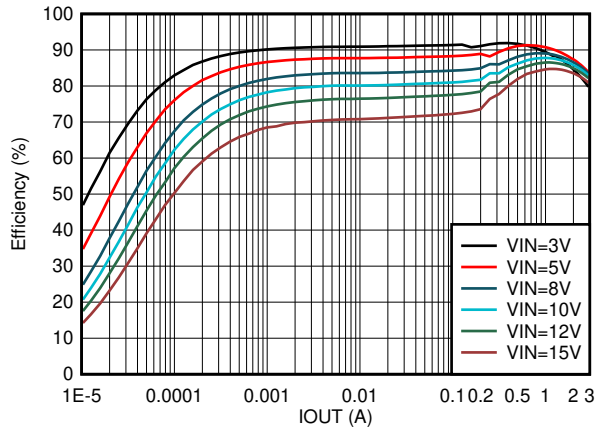

Auto PFM/PWM L = 2.2 μ H F_{sw} = 1 MHz

Figure 8-17. Efficiency vs Output Current V_{OUT} = 1.2 V

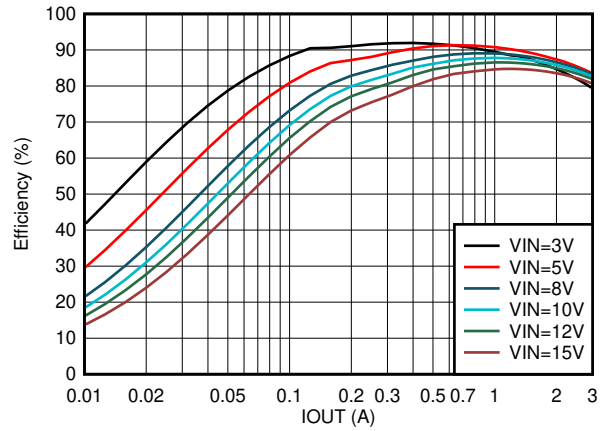

FPWM L = 2.2 μ H F_{sw} = 1 MHz

Figure 8-18. Efficiency vs Output Current V_{OUT} = 1.2 V

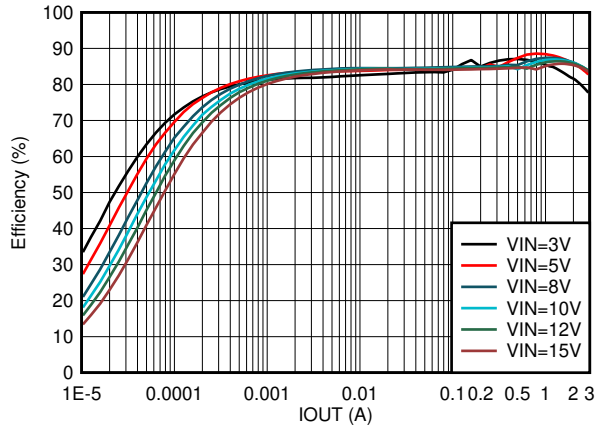

Auto PFM/PWM L = 1 μ H F_{sw} = 2.5 MHz

Figure 8-19. Efficiency vs Output Current V_{OUT} = 1.2 V

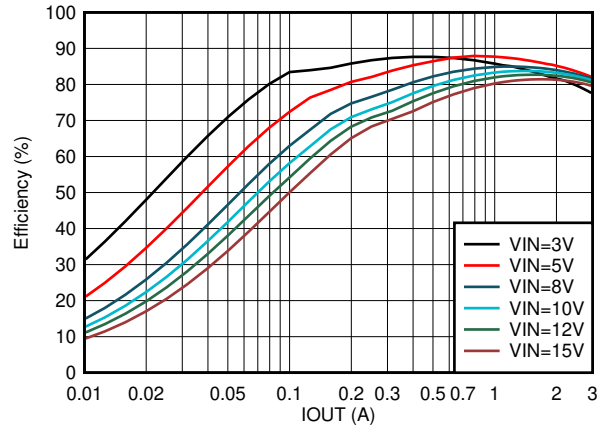

FPWM L = 1 μ H F_{sw} = 2.5 MHz

Figure 8-20. Efficiency vs Output Current V_{OUT} = 1.2 V

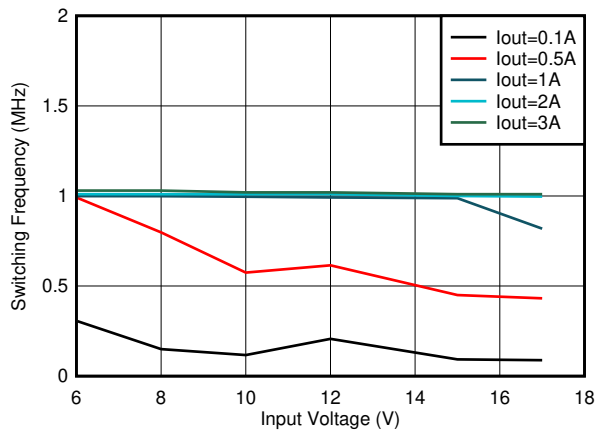

Auto PFM/PWM L = 2.2 μ H F_{sw} = 1 MHz

Figure 8-21. Switching Frequency vs Input Voltage V_{OUT} = 5 V

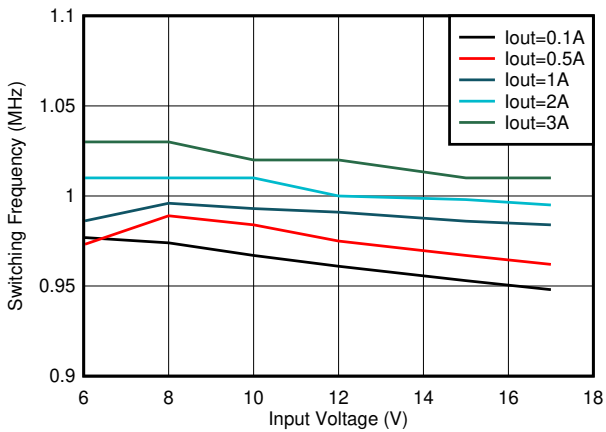

FPWM L = 2.2 μ H F_{sw} = 1 MHz

Figure 8-22. Switching Frequency vs Input Voltage V_{OUT} = 5 V

8.2.3 Application Curves (continued)

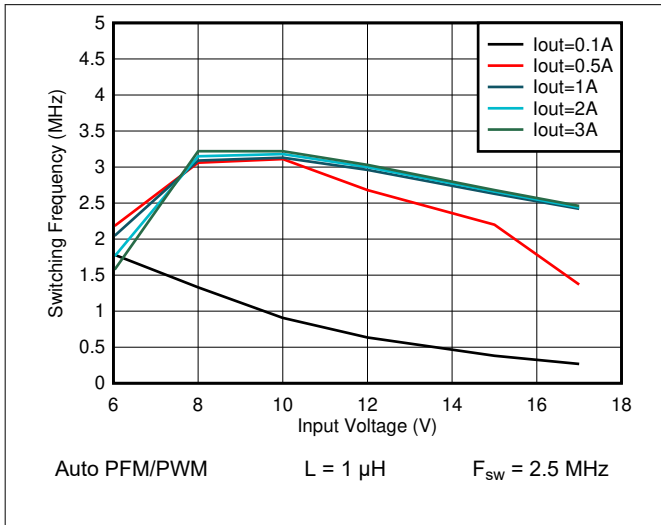

Figure 8-23. Switching Frequency vs Input Voltage V_{OUT} = 5 V

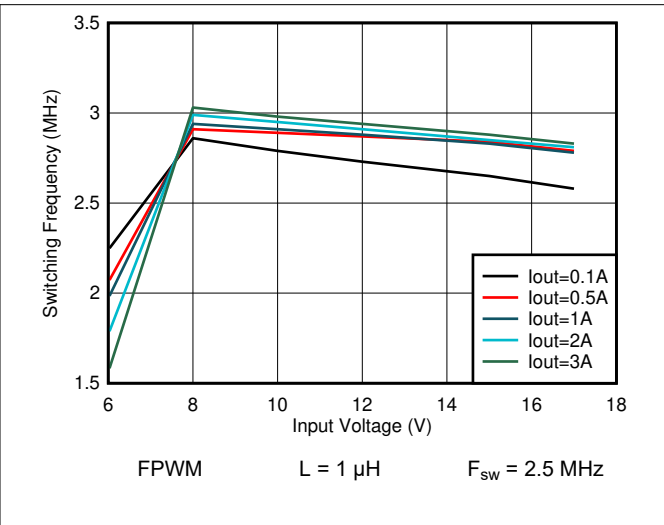

Figure 8-24. Switching Frequency vs Input Voltage V_{OUT} = 5 V

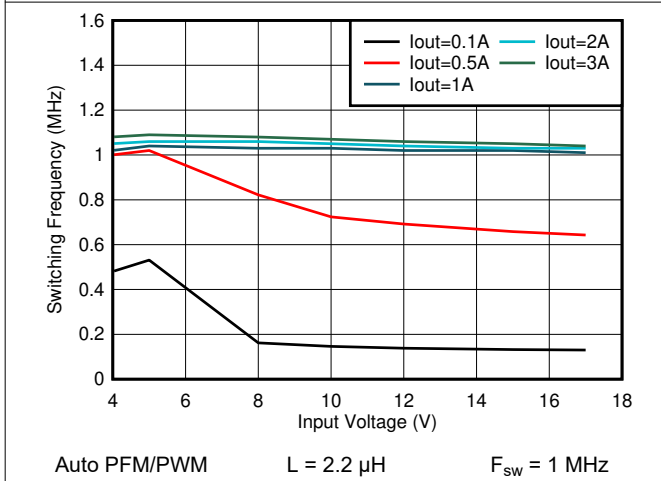

Figure 8-25. Switching Frequency vs Input Voltage V_{OUT} = 3.3 V

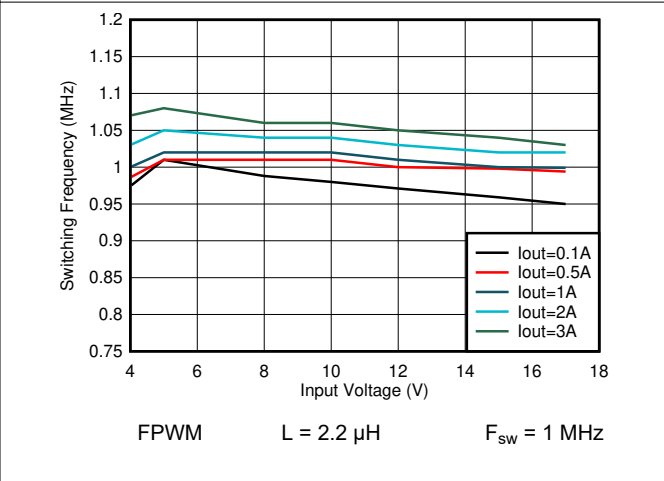

Figure 8-26. Switching Frequency vs Input Voltage V_{OUT} = 3.3 V

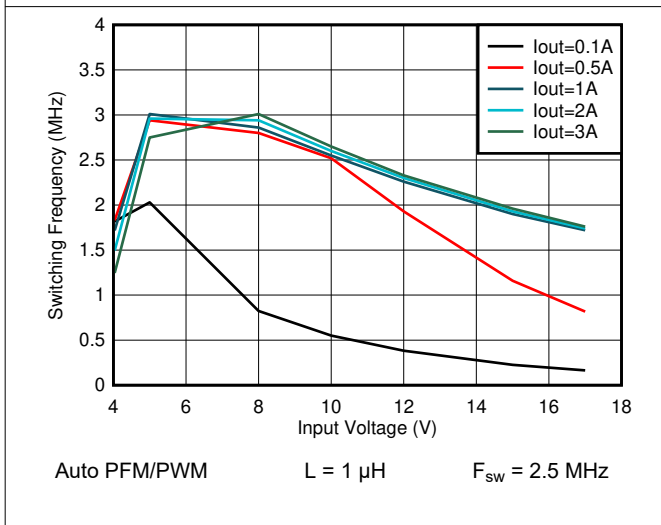

Figure 8-27. Switching Frequency vs Input Voltage V_{OUT} = 3.3 V

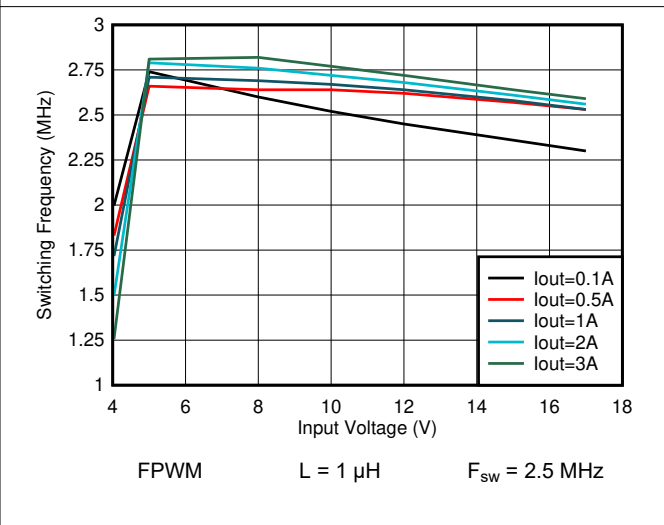

Figure 8-28. Switching Frequency vs Input Voltage V_{OUT} = 3.3 V

8.2.3 Application Curves (continued)

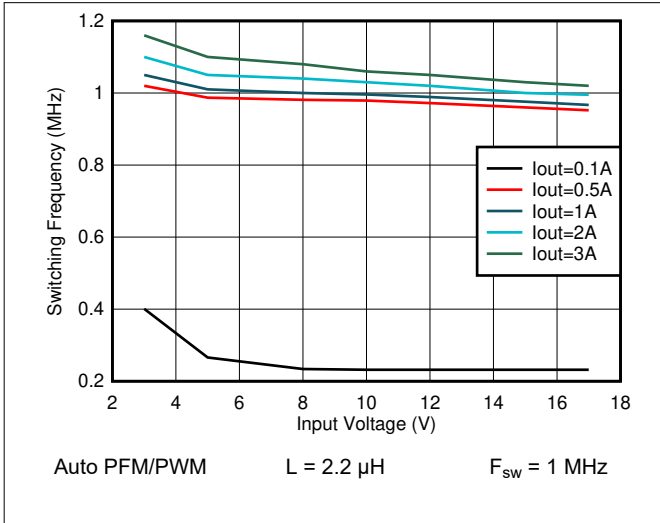

Figure 8-29. Switching Frequency vs Input Voltage V_{OUT} = 1.8 V

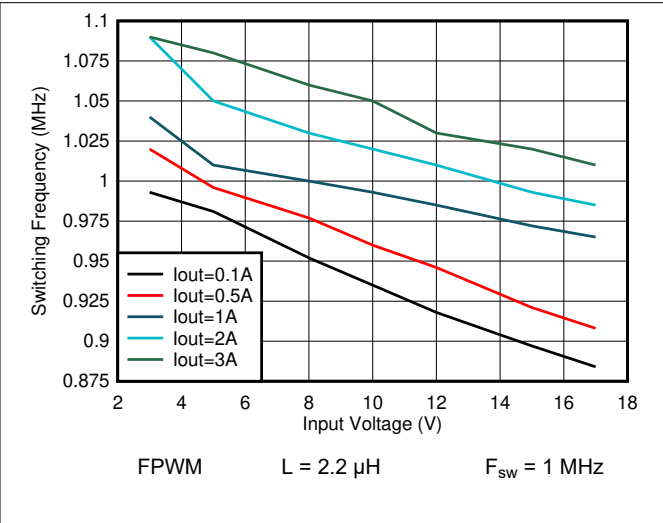

Figure 8-30. Switching Frequency vs Input Voltage V_{OUT} = 1.8 V

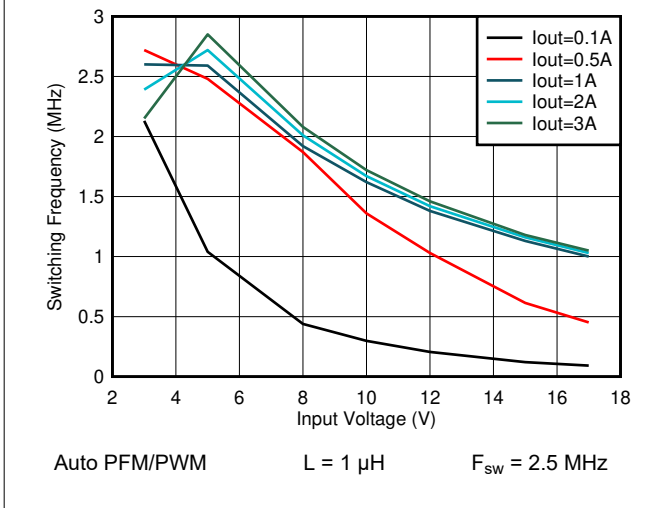

Figure 8-31. Switching Frequency vs Input Voltage V_{OUT} = 1.8 V

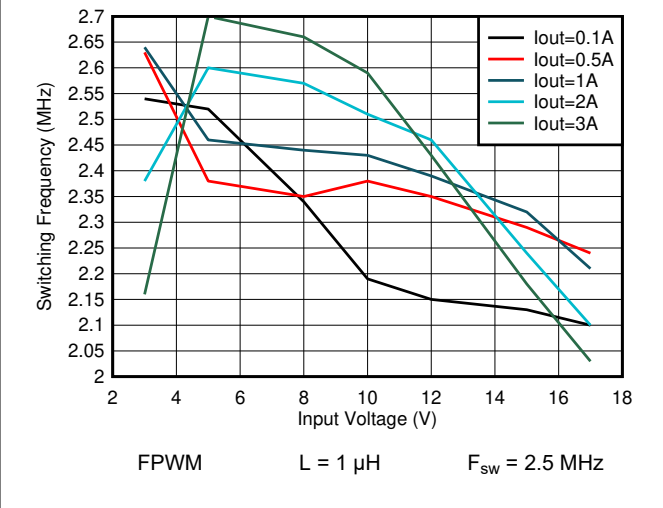

Figure 8-32. Switching Frequency vs Input Voltage V_{OUT} = 1.8 V

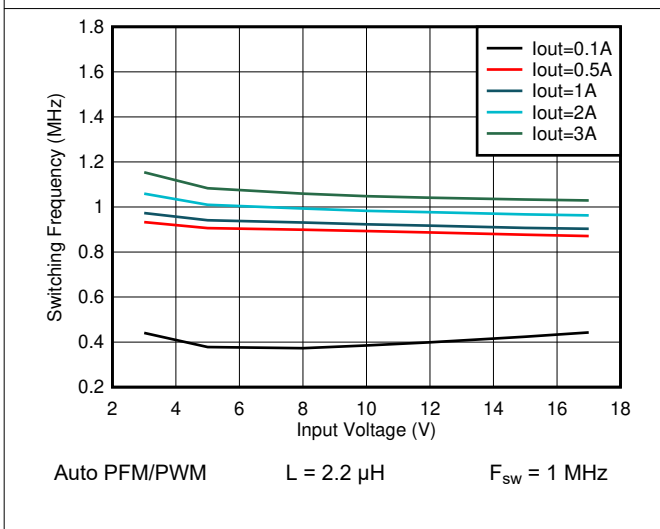

Figure 8-33. Switching Frequency vs Input Voltage V_{OUT} = 1.2 V

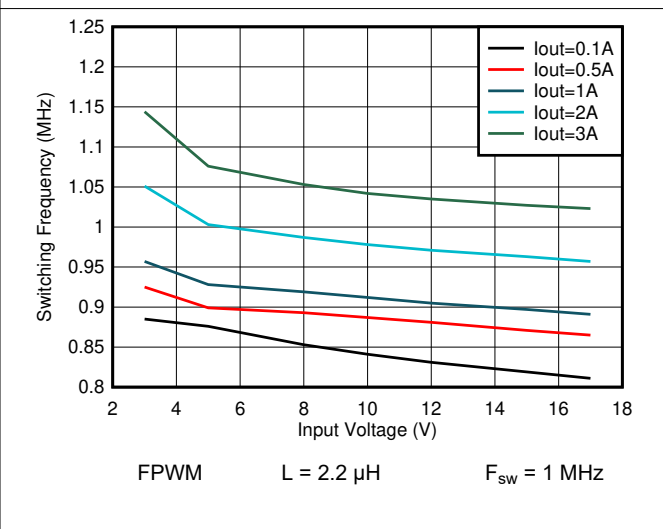
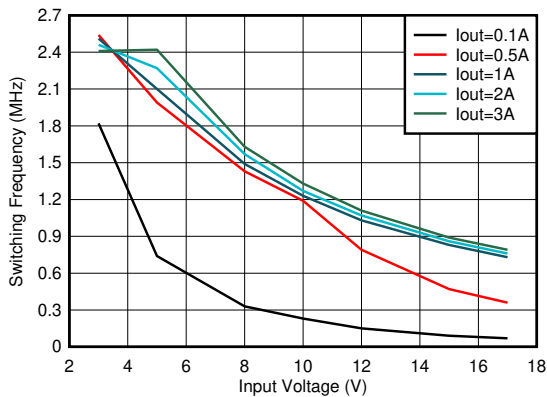

Figure 8-34. Switching Frequency vs Input Voltage V_{OUT} = 1.2 V

8.2.3 Application Curves (continued)



Auto PFM/PWM L = 1 μ H F_{sw} = 2.5 MHz

Figure 8-35. Switching Frequency vs Input Voltage $V_{OUT} = 1.2$ V

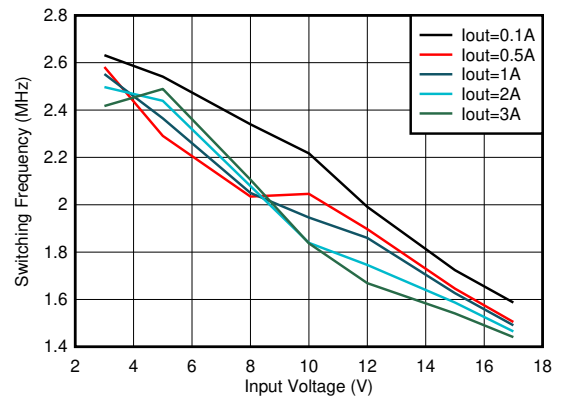

FPWM L = 1 μ H F_{sw} = 2.5 MHz

Figure 8-36. Switching Frequency vs Input Voltage $V_{OUT} = 1.2$ V

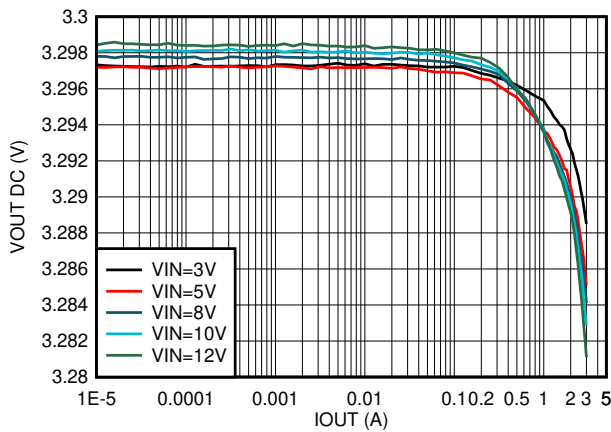

FPWM L = 1 μ H F_{sw} = 2.5 MHz

Figure 8-37. Output Voltage vs Output Current $V_{OUT} = 3.3$ V

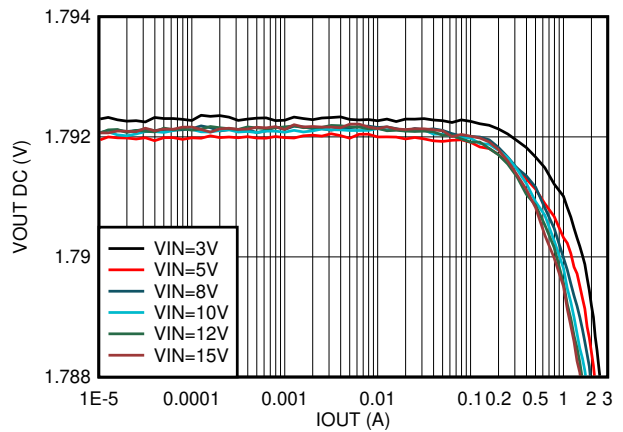

FPWM L = 1 μ H F_{sw} = 2.5 MHz

Figure 8-38. Output Voltage vs Output Current $V_{OUT} = 1.8$ V

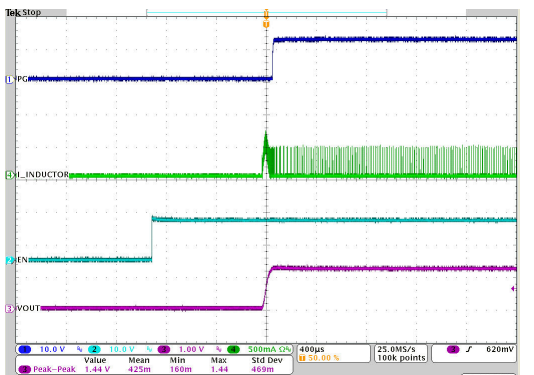

$V_{IN} = 12$ V 1 MHz Auto PFM/PWM $I_o = 10$ mA
 $V_{OUT} = 1.2$ V $T_A = 25^\circ\text{C}$

Figure 8-39. Start-up Timing

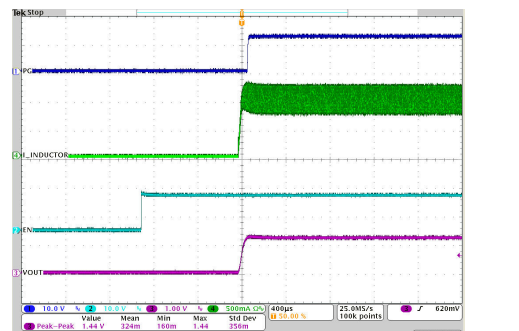

$V_{IN} = 12$ V 1 MHz Auto PFM/PWM $I_o = 1$ A
 $V_{OUT} = 1.2$ V $T_A = 25^\circ\text{C}$

Figure 8-40. Start-up Timing

8.2.3 Application Curves (continued)

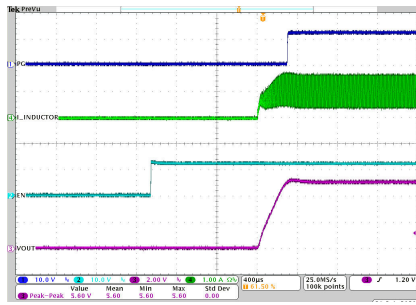

$V_{IN} = 12\text{ V}$ 1 MHz Auto $I_o = 1\text{ A}$
 PFM/PWM
 $V_{OUT} = 5\text{ V}$ $T_A = 25^\circ\text{C}$

Figure 8-41. Start-up Timing

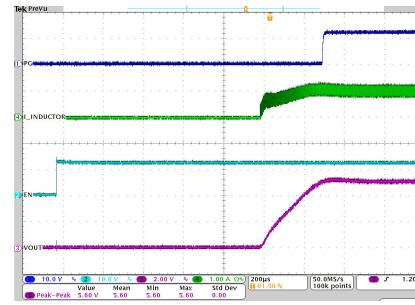

$V_{IN} = 12\text{ V}$ 2.5 MHz Auto $I_o = 1\text{ A}$
 PFM/PWM
 $V_{OUT} = 5\text{ V}$ $T_A = 25^\circ\text{C}$

Figure 8-42. Start-up Timing

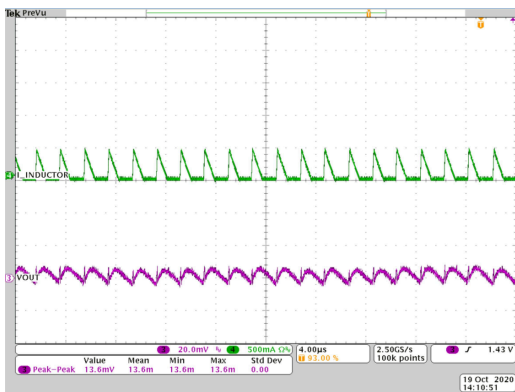

$V_{IN} = 12\text{ V}$ 1 MHz Auto $I_o = 0.1\text{ A}$
 PFM/PWM
 $V_{OUT} = 1.2\text{ V}$ $L = 2.2\ \mu\text{H}$ $T_A = 25^\circ\text{C}$

Figure 8-43. Output Voltage Ripple

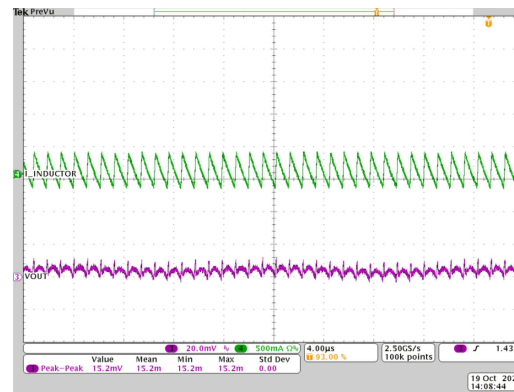

$V_{IN} = 12\text{ V}$ 1 MHz FPWM $I_o = 0.1\text{ A}$
 $V_{OUT} = 1.2\text{ V}$ $L = 2.2\ \mu\text{H}$ $T_A = 25^\circ\text{C}$

Figure 8-44. Output Voltage Ripple

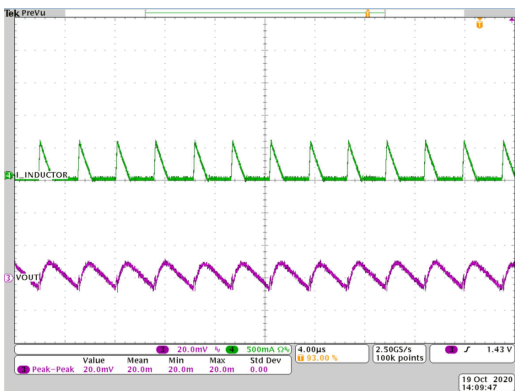

$V_{IN} = 12\text{ V}$ 2.5 MHz Auto $I_o = 0.1\text{ A}$
 PFM/PWM
 $V_{OUT} = 1.2\text{ V}$ $L = 2.2\ \mu\text{H}$ $T_A = 25^\circ\text{C}$

Figure 8-45. Output Voltage Ripple

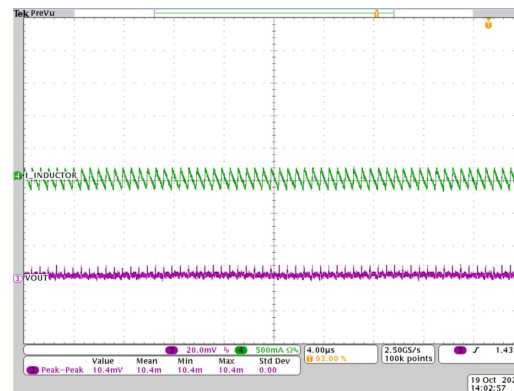

$V_{IN} = 12\text{ V}$ 2.5 MHz FPWM $I_o = 0.1\text{ A}$
 $V_{OUT} = 1.2\text{ V}$ $L = 2.2\ \mu\text{H}$ $T_A = 25^\circ\text{C}$

Figure 8-46. Output Voltage Ripple

8.2.3 Application Curves (continued)

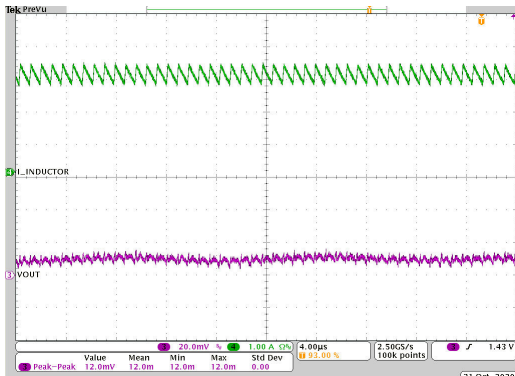

$V_{IN} = 12\text{ V}$ 1 MHz Auto PFM/PWM $I_o = 3\text{ A}$
 $V_{OUT} = 1.2\text{ V}$ $L = 2.2\text{ }\mu\text{H}$ $T_A = 25^\circ\text{C}$

Figure 8-47. Output Voltage Ripple

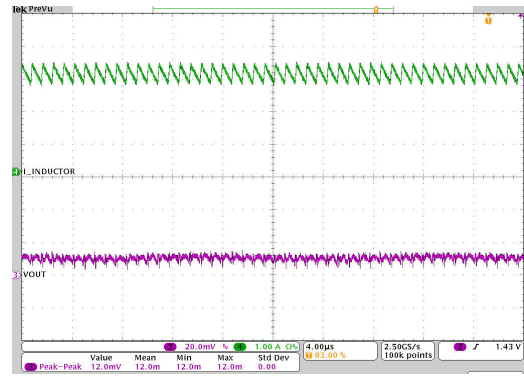

$V_{IN} = 12\text{ V}$ 1 MHz FPWM $I_o = 3\text{ A}$
 $V_{OUT} = 1.2\text{ V}$ $L = 2.2\text{ }\mu\text{H}$ $T_A = 25^\circ\text{C}$

Figure 8-48. Output Voltage Ripple

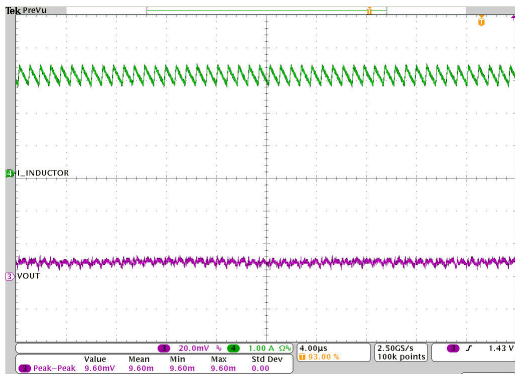

$V_{IN} = 12\text{ V}$ 2.5 MHz Auto PFM/PWM $I_o = 3\text{ A}$
 $V_{OUT} = 1.2\text{ V}$ $L = 2.2\text{ }\mu\text{H}$ $T_A = 25^\circ\text{C}$

Figure 8-49. Output Voltage Ripple

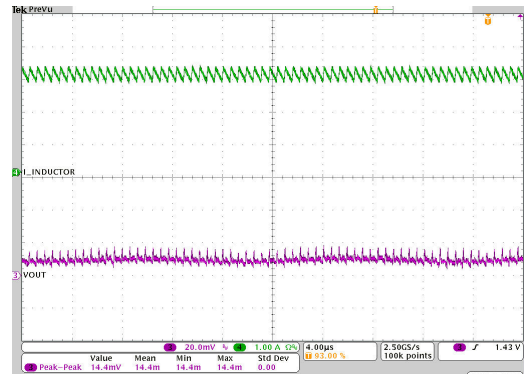

$V_{IN} = 12\text{ V}$ 2.5 MHz FPWM $I_o = 3\text{ A}$
 $V_{OUT} = 1.2\text{ V}$ $L = 2.2\text{ }\mu\text{H}$ $T_A = 25^\circ\text{C}$

Figure 8-50. Output Voltage Ripple

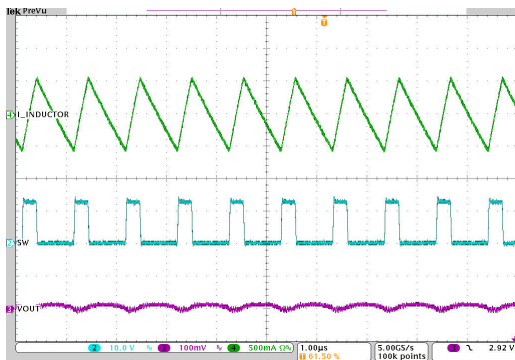

$V_{IN} = 12\text{ V}$ 1 MHz FPWM $I_o = 10\text{ mA}$
 $V_{OUT} = 3.0\text{ V}$ $L = 2.2\text{ }\mu\text{H}$ $T_A = 25^\circ\text{C}$

Figure 8-51. Typical Operation

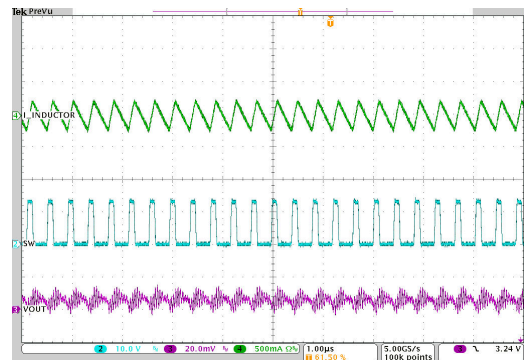

$V_{IN} = 12\text{ V}$ 2.5 MHz FPWM $I_o = 10\text{ mA}$
 $V_{OUT} = 3.0\text{ V}$ $L = 2.2\text{ }\mu\text{H}$ $T_A = 25^\circ\text{C}$

Figure 8-52. Typical Operation

8.2.3 Application Curves (continued)

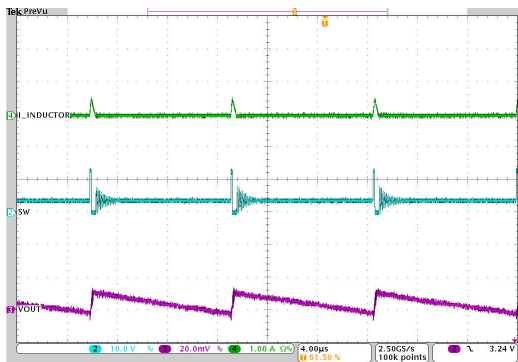

$V_{IN} = 12\text{ V}$ 2.5 MHz Auto $I_o = 10\text{ mA}$
 PFM/PWM
 $V_{OUT} = 3.0\text{ V}$ $L = 2.2\text{ }\mu\text{H}$ $T_A = 25^\circ\text{C}$

Figure 8-53. Typical Operation

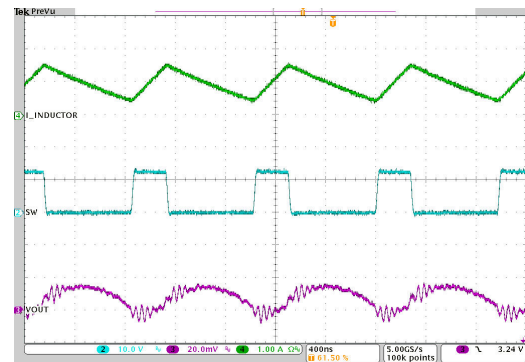

$V_{IN} = 12\text{ V}$ 1 MHz Auto $I_o = 1\text{ A}$
 PFM/PWM
 $V_{OUT} = 3.0\text{ V}$ $L = 2.2\text{ }\mu\text{H}$ $T_A = 25^\circ\text{C}$

Figure 8-54. Typical Operation

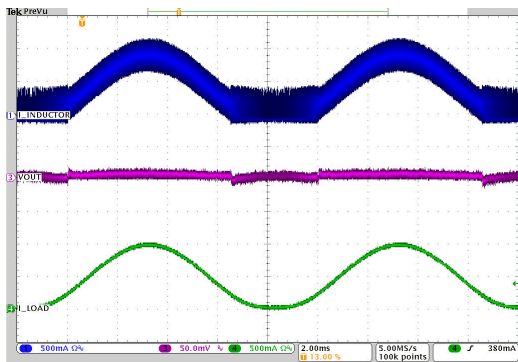

$V_{IN} = 12\text{ V}$ 1 MHz Auto $I_o = 0\text{ A to }1\text{ A}$
 PFM/PWM
 $V_{OUT} = 3.3\text{ V}$ $L = 2.2\text{ }\mu\text{H}$ $T_A = 25^\circ\text{C}$

Figure 8-55. PSM to PWM Transition

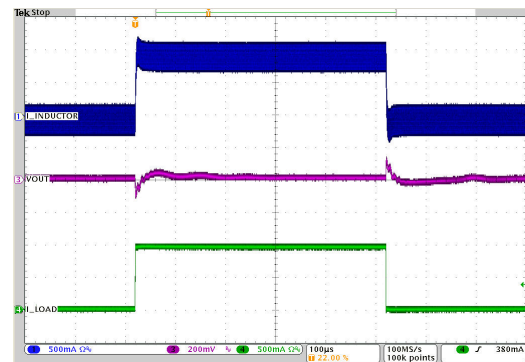

$V_{IN} = 12\text{ V}$ 2.5 MHz FPWM $I_o = 5\text{ mA to }1\text{ A to }5\text{ mA}$
 $V_{OUT} = 3.3\text{ V}$ $T_A = 25^\circ\text{C}$

Figure 8-56. Load Transient Response

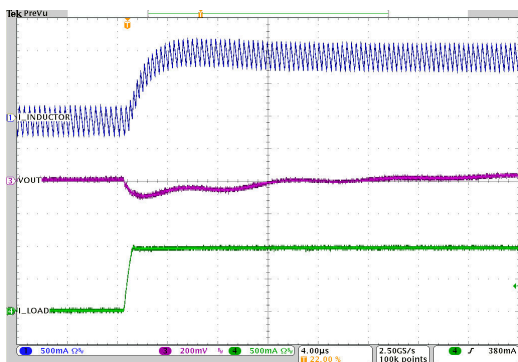

$V_{IN} = 12\text{ V}$ 2.5 MHz FPWM $I_o = 5\text{ mA to }1\text{ A}$
 $V_{OUT} = 3.3\text{ V}$ $T_A = 25^\circ\text{C}$

Figure 8-57. Load Transient Response - Rising Edge

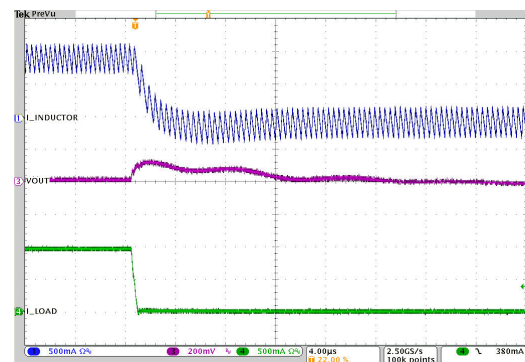

$V_{IN} = 12\text{ V}$ 2.5 MHz FPWM $I_o = 1\text{ A to }5\text{ mA}$
 $V_{OUT} = 3.3\text{ V}$ $T_A = 25^\circ\text{C}$

Figure 8-58. Load Transient Response - Falling Edge

8.2.4 Typical Application with Setable V_O using VSET

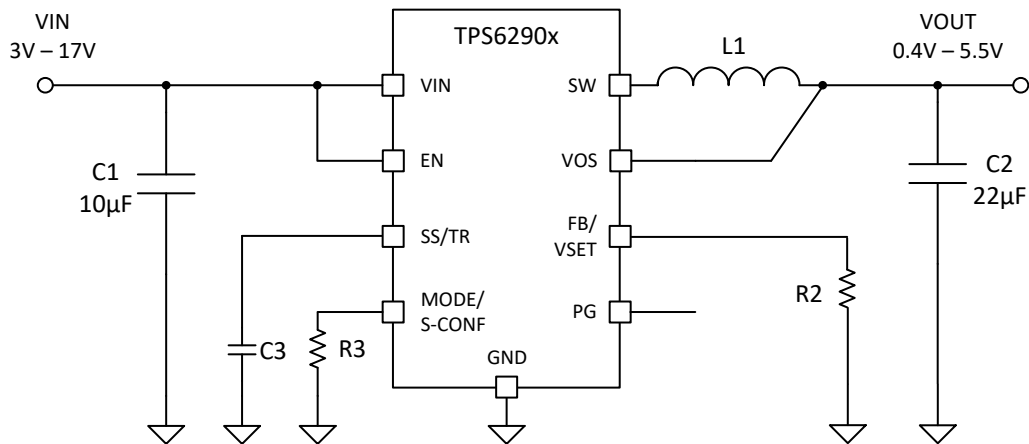

Figure 8-65. Typical Application Circuit (VSET)

8.2.4.1 Design Requirements

VSET allows you to set the output voltage using only one resistor to ground on the FB/VSET pin. [Table 7-2](#) shows the 16 available options.

8.2.4.2 Detailed Design Procedure

The VSET option needs to be selected using the MODE/S-CONF pin. Once the device is configured to VSET-operation, V_O is sensed only through the VOS-pin by an internal resistor divider. The target V_O is programmed by an external resistor R2 connected between FB/VSET and GND.

8.2.4.3 Application Curves

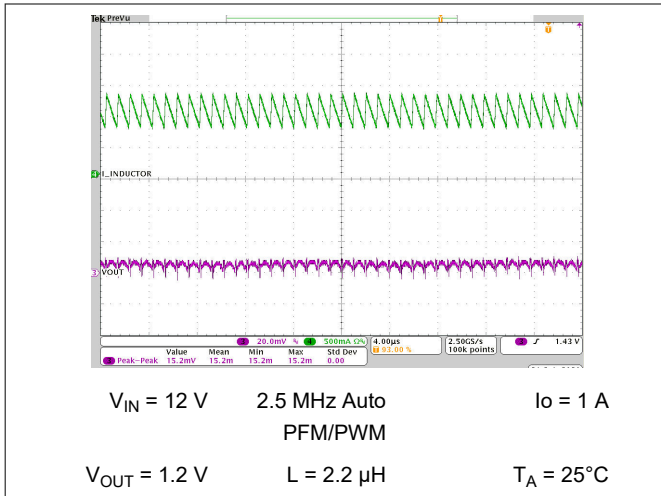

Figure 8-66. Output Voltage Ripple

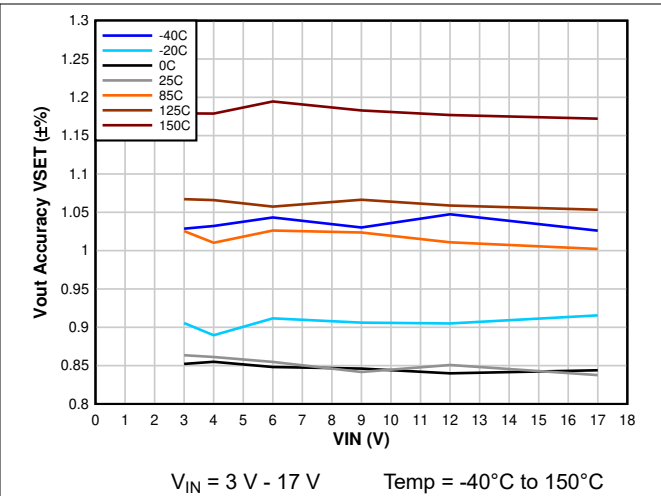

Figure 8-67. Output Voltage Accuracy - VSET Selected

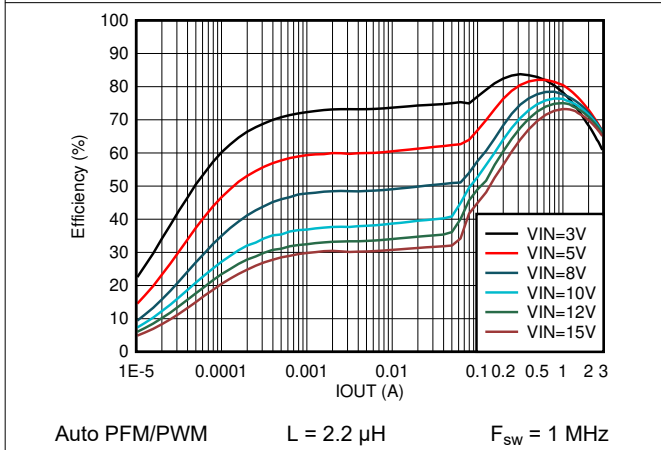

Figure 8-68. Efficiency vs Output Current $V_{OUT} = 0.4\text{ V}$

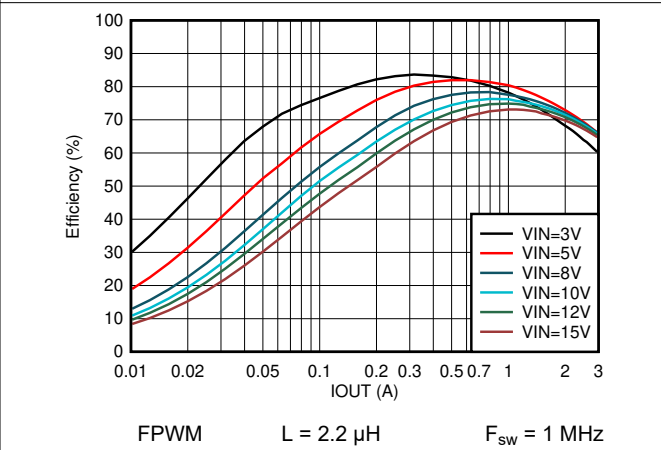

Figure 8-69. Efficiency vs Output Current $V_{OUT} = 0.4\text{ V}$

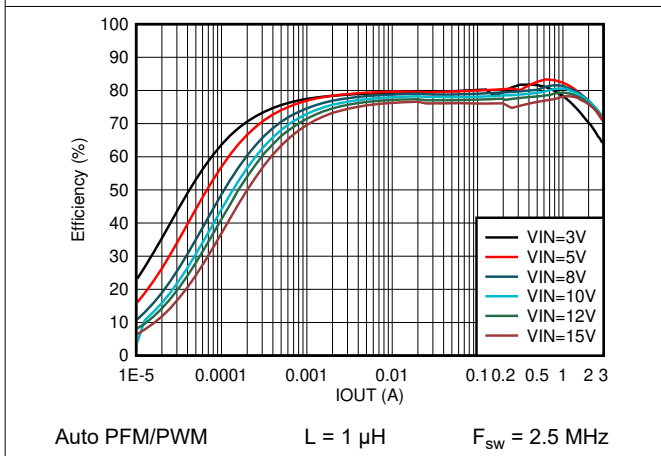

Figure 8-70. Efficiency vs Output Current $V_{OUT} = 0.4\text{ V}$

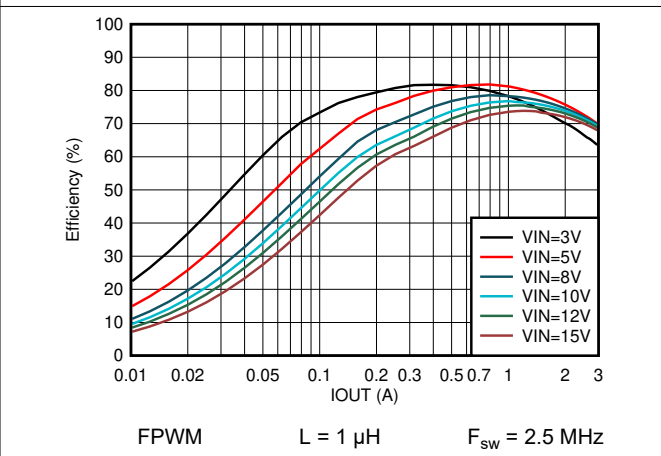

Figure 8-71. Efficiency vs Output Current $V_{OUT} = 0.4\text{ V}$

8.2.4.3 Application Curves (continued)

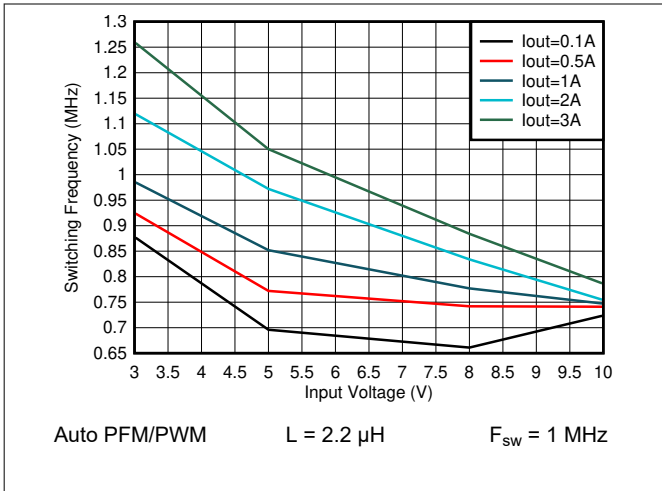

Figure 8-72. Switching Frequency vs Input Voltage V_{OUT} = 0.4 V

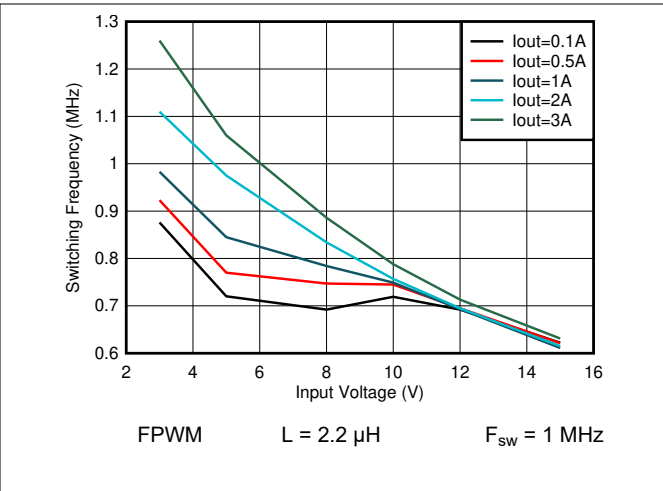

Figure 8-73. Switching Frequency vs Input Voltage V_{OUT} = 0.4 V

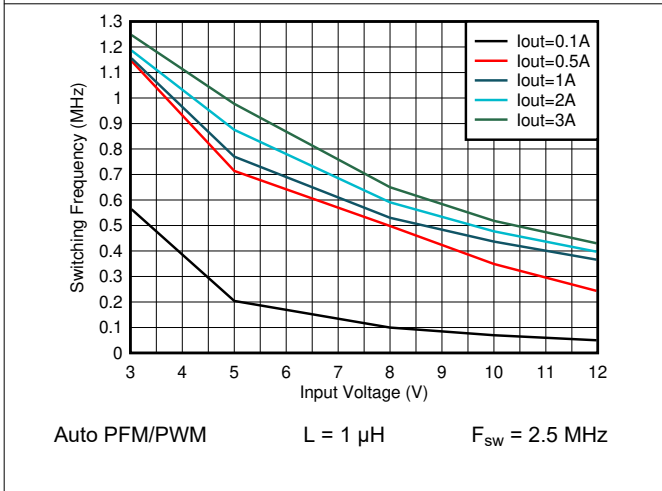

Figure 8-74. Switching Frequency vs Input Voltage V_{OUT} = 0.4 V

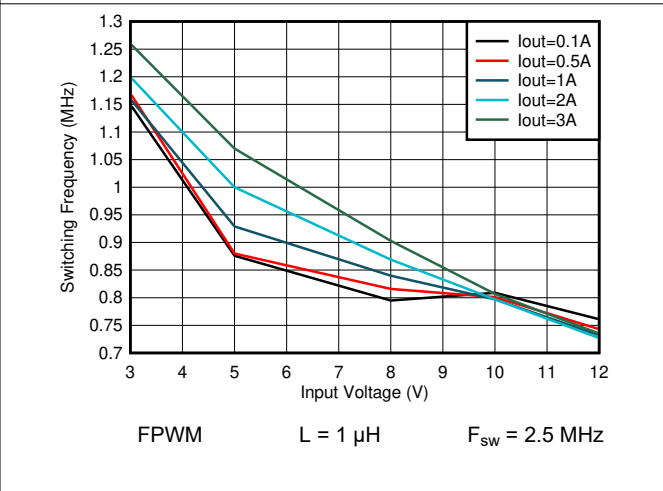

Figure 8-75. Switching Frequency vs Input Voltage V_{OUT} = 0.4 V

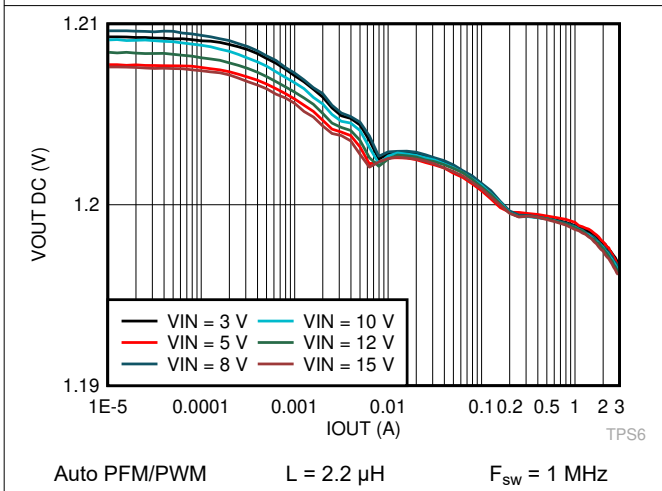

Figure 8-76. Output Voltage vs Output Current V_{OUT} = 1.2 V

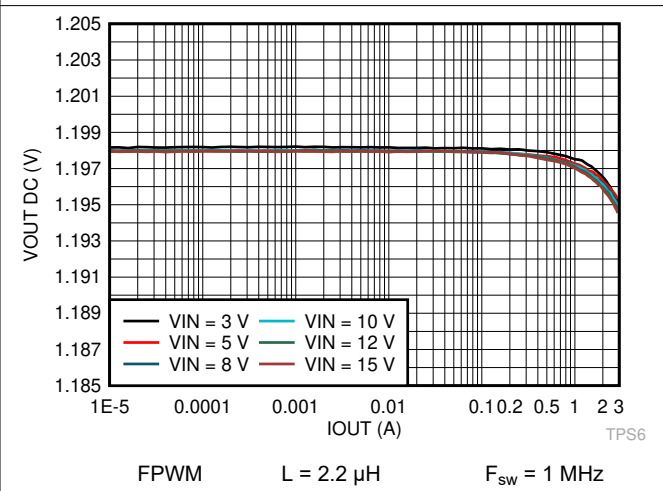

Figure 8-77. Output Voltage vs Output Current V_{OUT} = 1.2 V

8.2.4.3 Application Curves (continued)

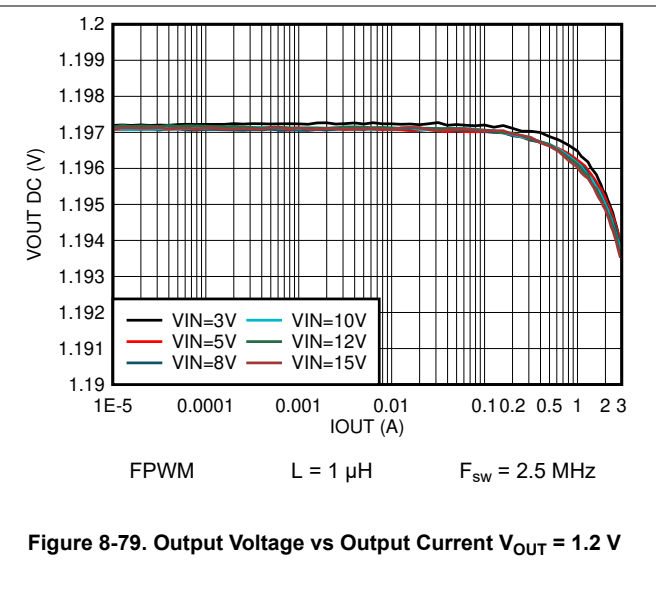
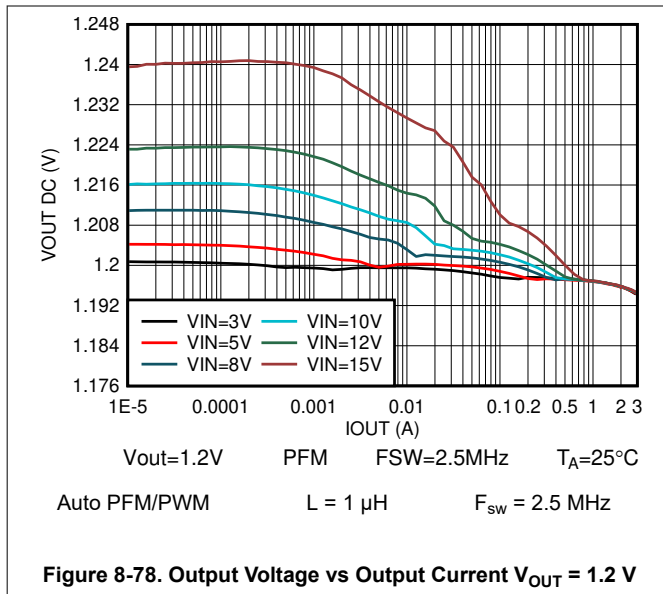

Figure 8-79. Output Voltage vs Output Current $V_{OUT} = 1.2\text{ V}$

8.3 System Examples

8.3.1 LED Power Supply

The TPS62903 can be used as a power supply for power LEDs. The FB pin can be easily set to lower values than nominal by using the SS/TR pin. With that, the voltage drop on the sense resistor is low to avoid excessive power loss. Since this pin provides $2.5\ \mu\text{A}$, the feedback pin voltage can be adjusted by an external resistor per Equation 19. This drop, proportional to the LED current, is used to regulate the output voltage (anode voltage) to a proper level to drive the LED. Both analog and PWM dimming are supported with the TPS62903. Figure 8-80 shows an application circuit, tested with analog dimming.

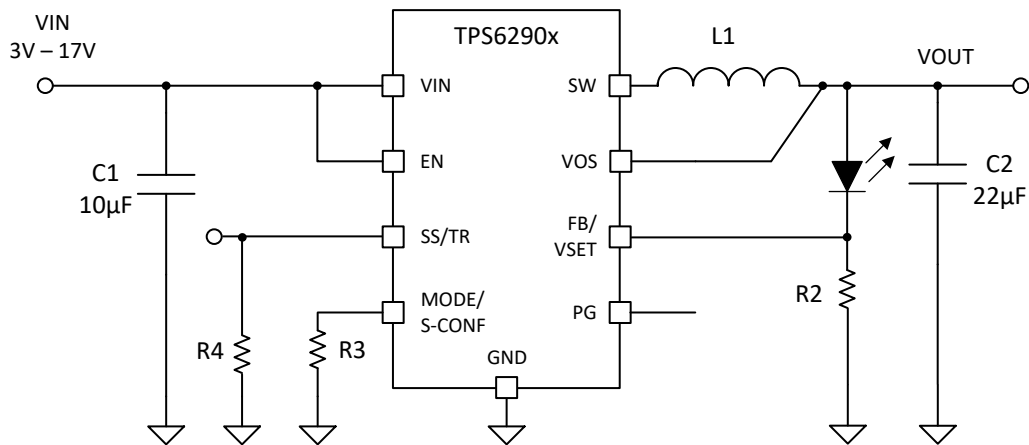

Figure 8-80. Single Power LED Supply

The resistor at SS/TR defines the FB voltage. It is set to 304 mV by $R_{SS/TR} = R4 = 162\ \text{k}\Omega$ using Equation 19. This cuts the losses on R4 to half from the nominal 0.6 V of feedback voltage while it still provides good accuracy.

$$V_{FB} = 0.75 \times 2.5\ \mu\text{A} \times R_{SS/TR} \quad (19)$$

The device now supplies a constant current set by resistor R2 from FB/VSET to GND. The minimum input voltage has to be rated according the forward voltage needed by the LED used. More information is available in [SLVA451](#).

8.3.2 Powering Multiple Loads

In applications where the TPS62903 is used to power multiple load circuits, the total capacitance on the output can be very large. In order to properly regulate the output voltage, there needs to be an appropriate AC signal level on the VOS pin. Tantalum capacitors have a large enough ESR to keep output voltage ripple sufficiently high on the VOS pin. With low-ESR ceramic capacitors, the output voltage ripple can get very low, so it is not recommended to use a large capacitance directly on the output of the device. If there are several load circuits with their associated input capacitor on a pcb, these loads are typically distributed across the board. This adds enough trace resistance (R_{trace}) to keep a large enough AC signal on the VOS pin for proper regulation.

The minimum total trace resistance on the distributed load is 10 m Ω . The total capacitance $n \times C_{\text{IN}}$ in the use case below was $32 \times 47 \mu\text{F}$ of ceramic X7R capacitors.

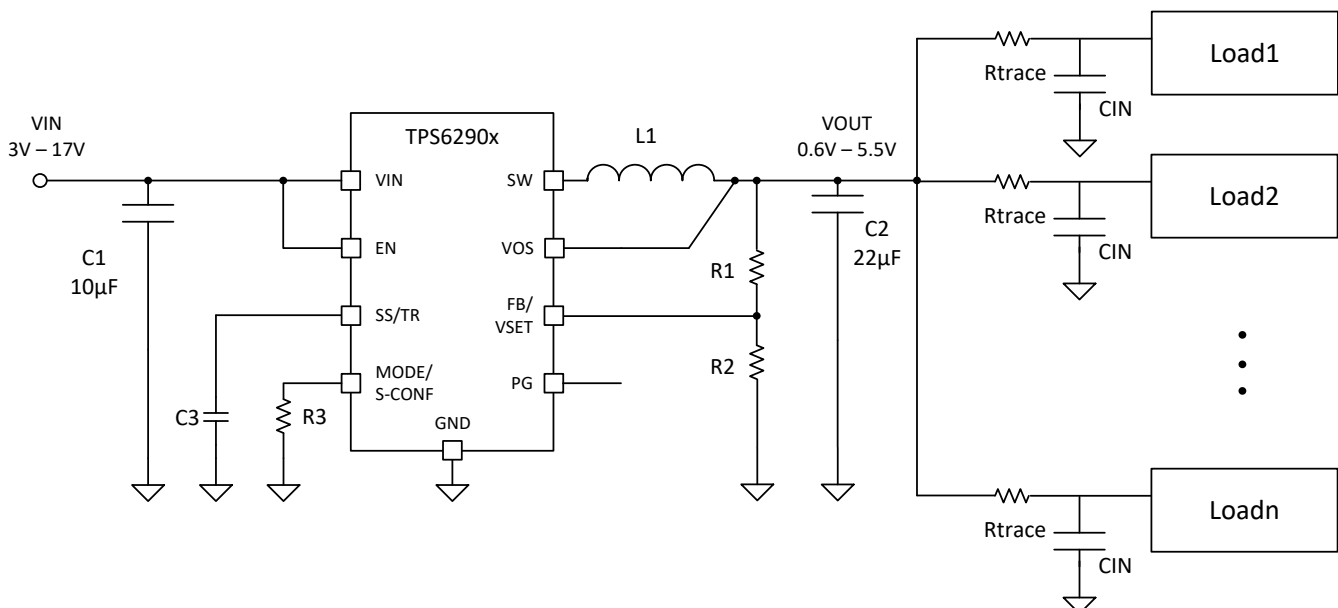

Figure 8-81. Multiple Loads

8.3.3 Voltage Tracking

Device 2 follows the voltage applied to the SS/TR pin. A ramp on SS/TR to 0.8 V ramps the output voltage according to the 0.6-V reference on V_{FB} .

Tracking the 3.8 V of device 1 requires a resistor divider on SS/TR of device 2 to output 0.8 V when the output voltage divider of device 1 is 0.6 V. The output current of 2.5 μA from the SS/TR pin causes an offset voltage on the resistor divider formed by R7 and R8. The equivalent resistance of $R7 \parallel R8$ should therefore be kept below 15 k Ω .

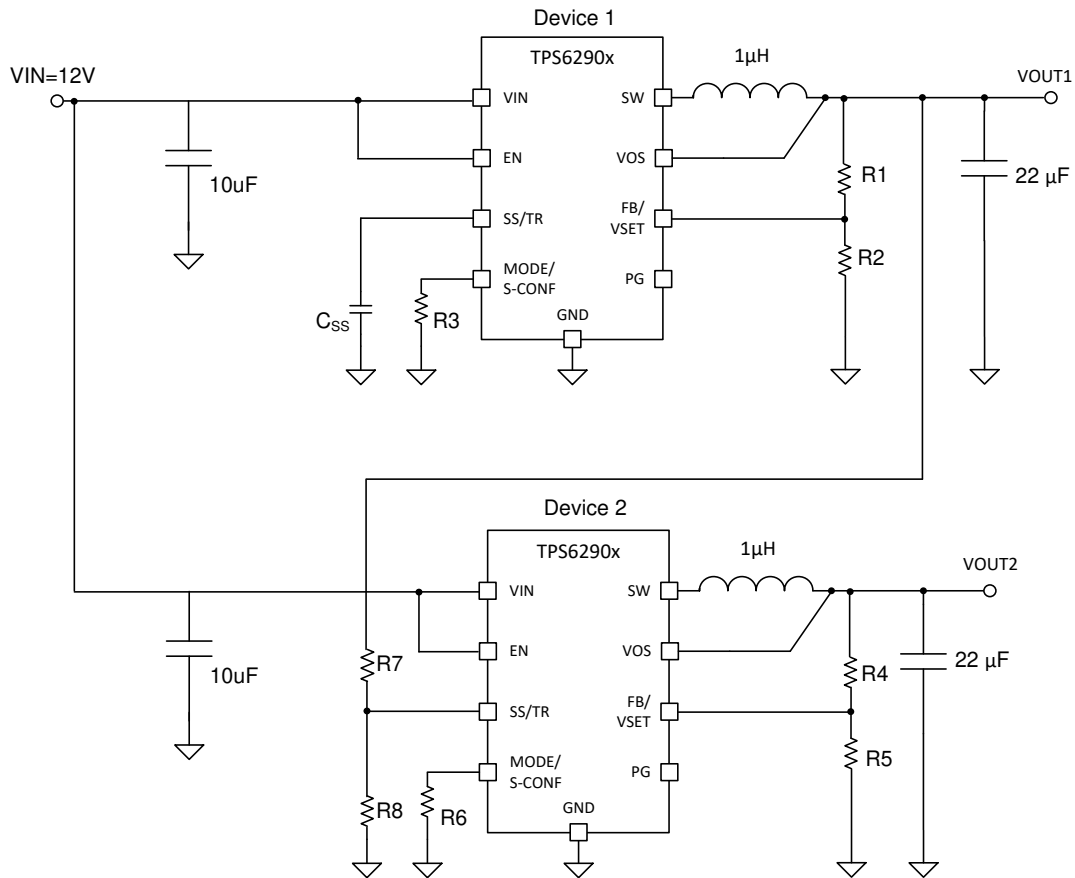

Figure 8-82. Tracking Example

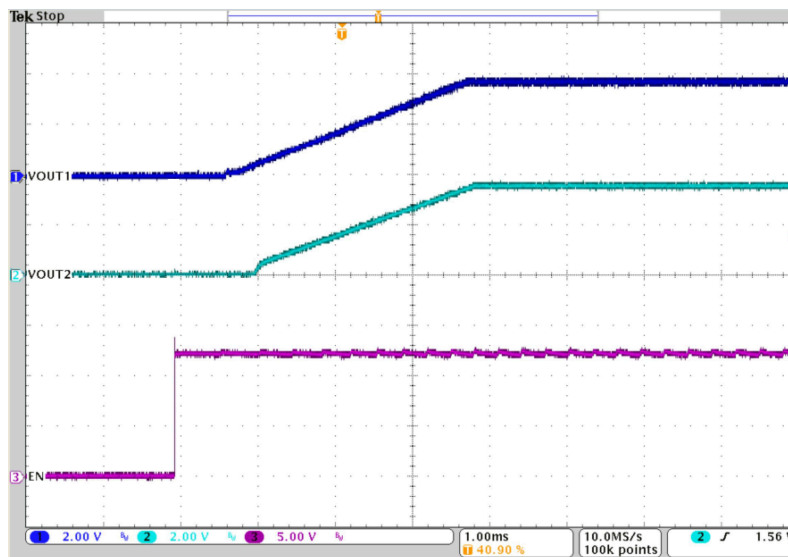

Figure 8-83. Tracking

9 Power Supply Recommendations

The power supply to the TPS62903 needs to have a current rating according to the supply voltage, output voltage, and output current of the TPS62903.

10 Layout

10.1 Layout Guidelines

A proper layout is critical for the operation of a switched mode power supply, even more at high switching frequencies. Therefore, the PCB layout of the TPS62903 demands careful attention to ensure operation and to get the performance specified. A poor layout can lead to issues like poor regulation (both line and load), stability and accuracy weaknesses, increased EMI radiation, and noise sensitivity.

See [Figure 10-1](#) for the recommended layout of the TPS62903, which is designed for common external ground connections. The input capacitor should be placed as close as possible between the VIN and GND pin of TPS62903. Also, connect the VOS pin in the shortest way to VOUT at the output capacitor.

Provide low inductive and resistive paths for loops with high di/dt. Therefore paths, conducting the switched load current should be as short and wide as possible. Provide low capacitive paths (with respect to all other nodes) for traces with high dv/dt. Therefore, the input and output capacitance should be placed as close as possible to the IC pins and parallel wiring over long distances as well as narrow traces should be avoided. Loops which conduct an alternating current should outline an area as small as possible, as this area is proportional to the energy radiated.

Sensitive nodes like FB and VOS need to be connected with short wires and not nearby high dv/dt signals (for example SW). As they carry information about the output voltage, they should be connected as close as possible to the actual output voltage (at the output capacitor). The capacitor on the SS/TR pin as well as the FB resistors, R1 and R2, should be kept close to the IC and connect directly to those pins and the system ground plane. The same applies to VSET resistor if VSET is used to scale the output voltage.

The package uses the pins for power dissipation. Thermal vias on the VIN and GND pins help to spread the heat through the pcb.

In case any of the digital inputs EN, and MODE/S-CONF need to be tied to the input supply voltage at V_{IN} , the connection must be made directly at the input capacitor as indicated in the schematics.

The recommended layout is implemented on the EVM and shown in its user's guide, [SNVU745](#).

10.2 Layout Example

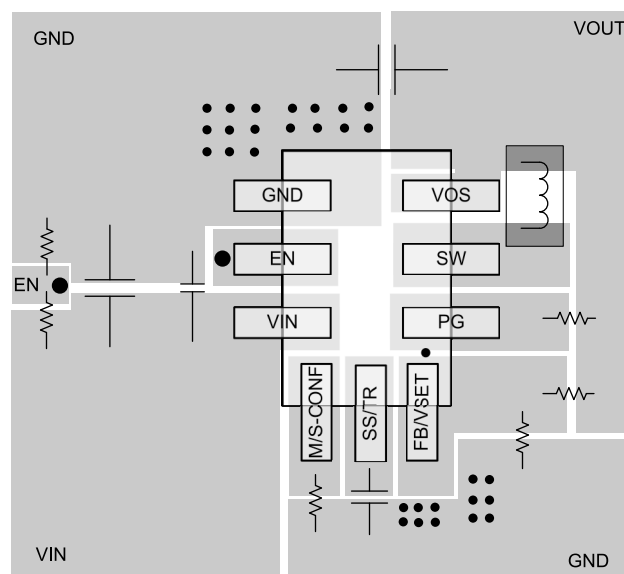

Figure 10-1. Layout

10.2.1 Thermal Considerations

Implementation of integrated circuits in low-profile and fine-pitch surface-mount packages typically requires special attention to power dissipation. Many system-dependent issues such as thermal coupling, airflow, added heat sinks and convection surfaces, and the presence of other heat-generating components affect the power-dissipation limits of a given component.

Three basic approaches for enhancing thermal performance are listed below:

- Improving the power dissipation capability of the PCB design, for example, increasing copper thickness, thermal vias, number of layers
- Introducing airflow in the system

For more details on how to use the thermal parameters, see the application notes: Thermal Characteristics Application Note ([SZZA017](#)), and ([SPRA953](#)).

The TPS62903 is designed for a maximum operating junction temperature (T_J) of 150°C. Therefore, the maximum output power is limited by the power losses that can be dissipated over the actual thermal resistance, given by the package and the surrounding PCB structures. If the thermal resistance of the package is given, the size of the surrounding copper area and a proper thermal connection of the IC can reduce the thermal resistance. To get an improved thermal behavior, it is recommended to use top layer metal to connect the device with wide and thick metal lines. Internal ground layers can connect to vias directly under the IC for improved thermal performance.

If short circuit or overload conditions are present, the device is protected by limiting internal power dissipation.

The device is qualified for long term qualification with 150°C junction. For more details about the derating and life time of the HotRod package, see the application note: [SPRACS3](#).

11 Device and Documentation Support

11.1 Device Support

11.1.1 Development Support

11.1.1.1 Custom Design With WEBENCH® Tools

[Click here](#) to create a custom design using the TPS62903 device with the WEBENCH® Power Designer.

1. Start by entering the input voltage (V_{IN}), output voltage (V_{OUT}), and output current (I_{OUT}) requirements.
2. Optimize the design for key parameters such as efficiency, footprint, and cost using the optimizer dial.
3. Compare the generated design with other possible solutions from Texas Instruments.

The WEBENCH Power Designer provides a customized schematic along with a list of materials with real-time pricing and component availability.

In most cases, these actions are available:

- Run electrical simulations to see important waveforms and circuit performance
- Run thermal simulations to understand board thermal performance
- Export customized schematic and layout into popular CAD formats
- Print PDF reports for the design, and share the design with colleagues

Get more information about WEBENCH tools at www.ti.com/WEBENCH.

11.2 Receiving Notification of Documentation Updates

To receive notification of documentation updates, navigate to the device product folder on ti.com. Click on *Subscribe to updates* to register and receive a weekly digest of any product information that has changed. For change details, review the revision history included in any revised document.

11.3 Support Resources

[TI E2E™ support forums](#) are an engineer's go-to source for fast, verified answers and design help — straight from the experts. Search existing answers or ask your own question to get the quick design help you need.

Linked content is provided "AS IS" by the respective contributors. They do not constitute TI specifications and do not necessarily reflect TI's views; see TI's [Terms of Use](#).

11.4 Trademarks

DCS-Control™ and TI E2E™ are trademarks of Texas Instruments.

SmartConfig™ is a trademark of Texas Instruments.

WEBENCH® is a registered trademark of Texas Instruments.

All trademarks are the property of their respective owners.

11.5 Electrostatic Discharge Caution



This integrated circuit can be damaged by ESD. Texas Instruments recommends that all integrated circuits be handled with appropriate precautions. Failure to observe proper handling and installation procedures can cause damage.

ESD damage can range from subtle performance degradation to complete device failure. Precision integrated circuits may be more susceptible to damage because very small parametric changes could cause the device not to meet its published specifications.

11.6 Glossary

[TI Glossary](#) This glossary lists and explains terms, acronyms, and definitions.

12 Mechanical, Packaging, and Orderable Information

The following pages include mechanical, packaging, and orderable information. This information is the most current data available for the designated devices. This data is subject to change without notice and revision of this document. For browser-based versions of this data sheet, refer to the left-hand navigation.



RPJ0009A

PACKAGE OUTLINE
VQFN-HR - 1 mm max height

PLASTIC QUAD FLATPACK - NO LEAD

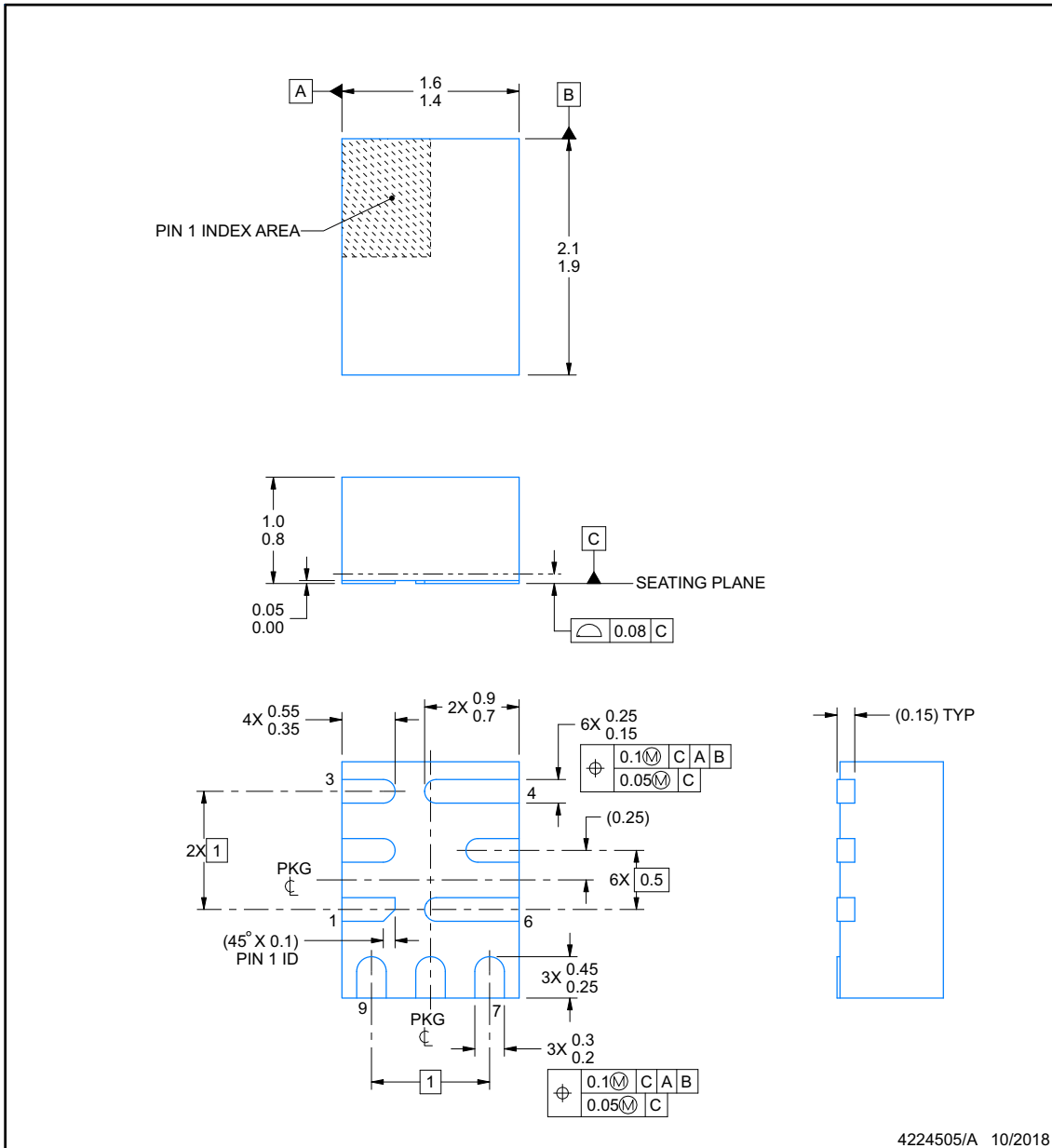

NOTES:

1. All linear dimensions are in millimeters. Any dimensions in parenthesis are for reference only. Dimensioning and tolerancing per ASME Y14.5M.
2. This drawing is subject to change without notice.

EXAMPLE BOARD LAYOUT

RPJ0009A

VQFN-HR - 1 mm max height

PLASTIC QUAD FLATPACK - NO LEAD

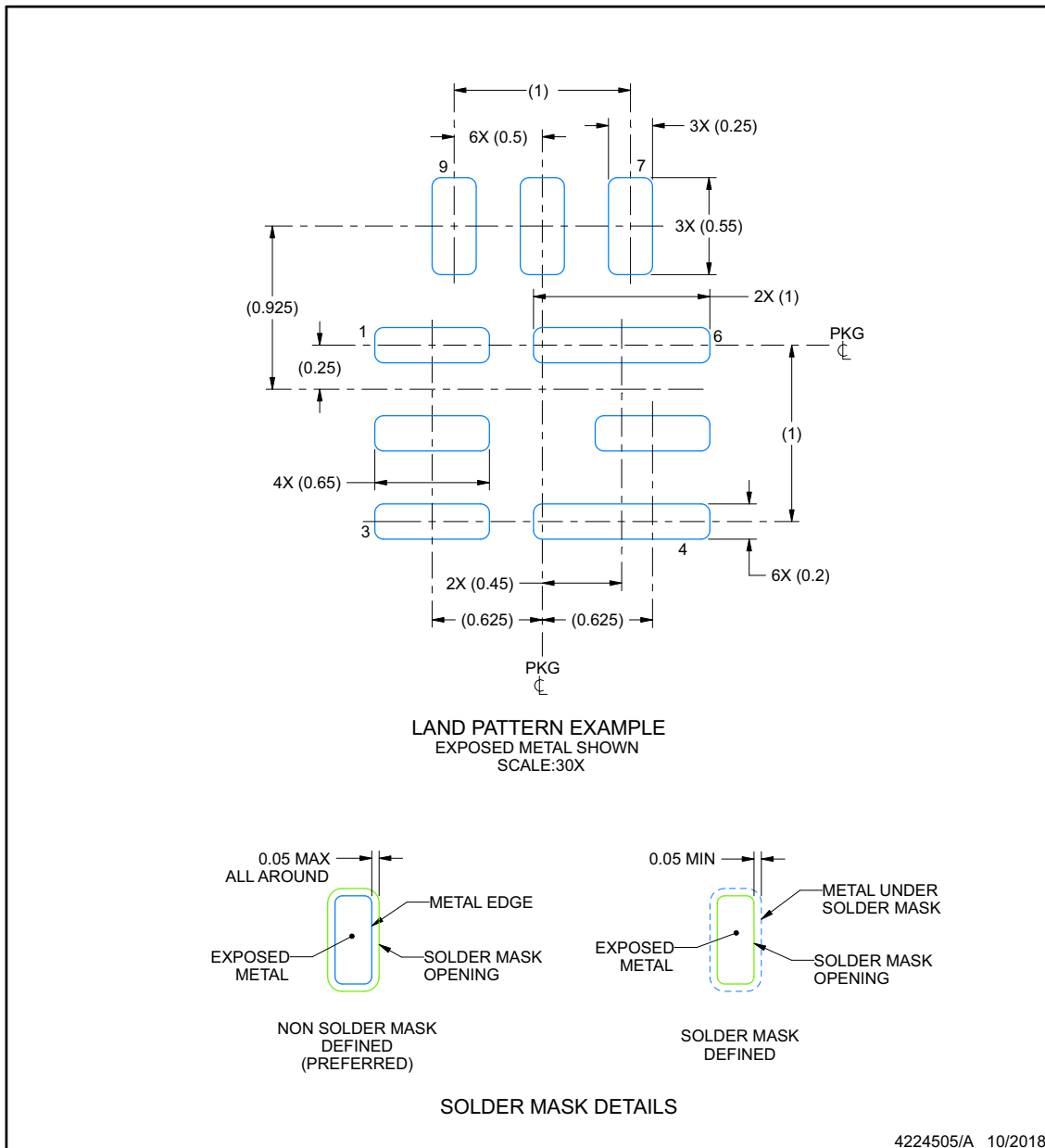

NOTES: (continued)

- 3. For more information, see Texas Instruments literature number SLUA271 (www.ti.com/lit/sluea271).
- 4. Solder mask tolerances between and around signal pads can vary based on board fabrication site.

EXAMPLE STENCIL DESIGN

RPJ0009A

VQFN-HR - 1 mm max height

PLASTIC QUAD FLATPACK - NO LEAD

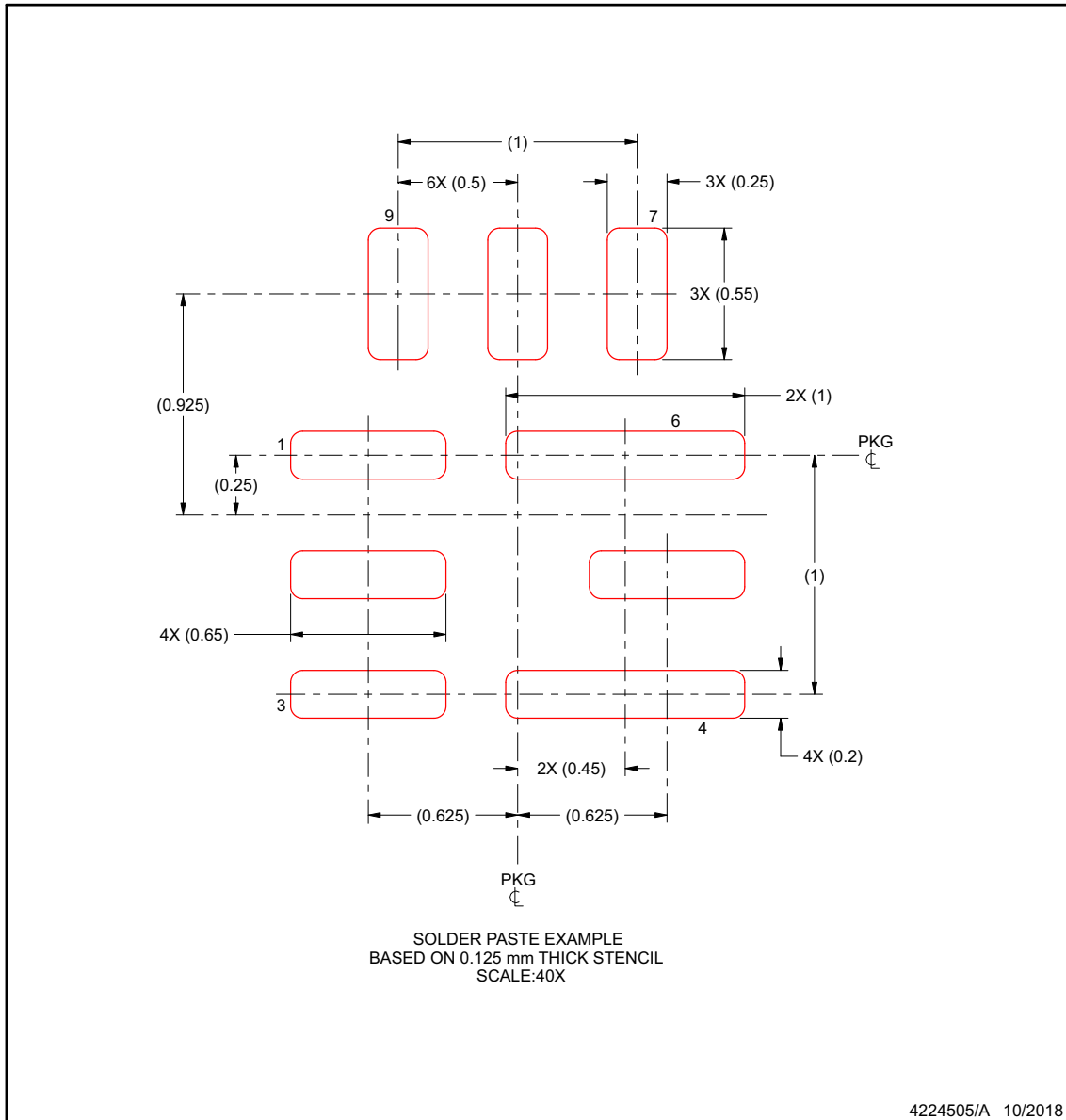

NOTES: (continued)

5. For alternate stencil design recommendations, see IPC-7525 or board assembly site preference.

PACKAGING INFORMATION

Orderable Device	Status (1)	Package Type	Package Drawing	Pins	Package Qty	Eco Plan (2)	Lead finish/ Ball material (6)	MSL Peak Temp (3)	Op Temp (°C)	Device Marking (4/5)	Samples
TPS62903RPJR	ACTIVE	VQFN-HR	RPJ	9	3000	RoHS & Green	SN	Level-2-260C-1 YEAR	-40 to 150	FN8	Samples

(1) The marketing status values are defined as follows:

ACTIVE: Product device recommended for new designs.

LIFEBUY: TI has announced that the device will be discontinued, and a lifetime-buy period is in effect.

NRND: Not recommended for new designs. Device is in production to support existing customers, but TI does not recommend using this part in a new design.

PREVIEW: Device has been announced but is not in production. Samples may or may not be available.

OBSELETE: TI has discontinued the production of the device.

(2) **RoHS:** TI defines "RoHS" to mean semiconductor products that are compliant with the current EU RoHS requirements for all 10 RoHS substances, including the requirement that RoHS substance do not exceed 0.1% by weight in homogeneous materials. Where designed to be soldered at high temperatures, "RoHS" products are suitable for use in specified lead-free processes. TI may reference these types of products as "Pb-Free".

RoHS Exempt: TI defines "RoHS Exempt" to mean products that contain lead but are compliant with EU RoHS pursuant to a specific EU RoHS exemption.

Green: TI defines "Green" to mean the content of Chlorine (Cl) and Bromine (Br) based flame retardants meet JS709B low halogen requirements of <=1000ppm threshold. Antimony trioxide based flame retardants must also meet the <=1000ppm threshold requirement.

(3) MSL, Peak Temp. - The Moisture Sensitivity Level rating according to the JEDEC industry standard classifications, and peak solder temperature.

(4) There may be additional marking, which relates to the logo, the lot trace code information, or the environmental category on the device.

(5) Multiple Device Markings will be inside parentheses. Only one Device Marking contained in parentheses and separated by a "-" will appear on a device. If a line is indented then it is a continuation of the previous line and the two combined represent the entire Device Marking for that device.

(6) Lead finish/Ball material - Orderable Devices may have multiple material finish options. Finish options are separated by a vertical ruled line. Lead finish/Ball material values may wrap to two lines if the finish value exceeds the maximum column width.

Important Information and Disclaimer:The information provided on this page represents TI's knowledge and belief as of the date that it is provided. TI bases its knowledge and belief on information provided by third parties, and makes no representation or warranty as to the accuracy of such information. Efforts are underway to better integrate information from third parties. TI has taken and continues to take reasonable steps to provide representative and accurate information but may not have conducted destructive testing or chemical analysis on incoming materials and chemicals. TI and TI suppliers consider certain information to be proprietary, and thus CAS numbers and other limited information may not be available for release.

In no event shall TI's liability arising out of such information exceed the total purchase price of the TI part(s) at issue in this document sold by TI to Customer on an annual basis.

OTHER QUALIFIED VERSIONS OF TPS62903 :

- Automotive : [TPS62903-Q1](#)

NOTE: Qualified Version Definitions:

- Automotive - Q100 devices qualified for high-reliability automotive applications targeting zero defects

TAPE AND REEL INFORMATION

QUADRANT ASSIGNMENTS FOR PIN 1 ORIENTATION IN TAPE

*All dimensions are nominal

Device	Package Type	Package Drawing	Pins	SPQ	Reel Diameter (mm)	Reel Width W1 (mm)	A0 (mm)	B0 (mm)	K0 (mm)	P1 (mm)	W (mm)	Pin1 Quadrant
TPS62903RPJR	VQFN-HR	RPJ	9	3000	180.0	8.4	1.75	2.25	1.0	4.0	8.0	Q1

TAPE AND REEL BOX DIMENSIONS

*All dimensions are nominal

Device	Package Type	Package Drawing	Pins	SPQ	Length (mm)	Width (mm)	Height (mm)
TPS62903RPJR	VQFN-HR	RPJ	9	3000	210.0	185.0	35.0

IMPORTANT NOTICE AND DISCLAIMER

TI PROVIDES TECHNICAL AND RELIABILITY DATA (INCLUDING DATA SHEETS), DESIGN RESOURCES (INCLUDING REFERENCE DESIGNS), APPLICATION OR OTHER DESIGN ADVICE, WEB TOOLS, SAFETY INFORMATION, AND OTHER RESOURCES "AS IS" AND WITH ALL FAULTS, AND DISCLAIMS ALL WARRANTIES, EXPRESS AND IMPLIED, INCLUDING WITHOUT LIMITATION ANY IMPLIED WARRANTIES OF MERCHANTABILITY, FITNESS FOR A PARTICULAR PURPOSE OR NON-INFRINGEMENT OF THIRD PARTY INTELLECTUAL PROPERTY RIGHTS.

These resources are intended for skilled developers designing with TI products. You are solely responsible for (1) selecting the appropriate TI products for your application, (2) designing, validating and testing your application, and (3) ensuring your application meets applicable standards, and any other safety, security, regulatory or other requirements.

These resources are subject to change without notice. TI grants you permission to use these resources only for development of an application that uses the TI products described in the resource. Other reproduction and display of these resources is prohibited. No license is granted to any other TI intellectual property right or to any third party intellectual property right. TI disclaims responsibility for, and you will fully indemnify TI and its representatives against, any claims, damages, costs, losses, and liabilities arising out of your use of these resources.

TI's products are provided subject to [TI's Terms of Sale](#) or other applicable terms available either on [ti.com](https://www.ti.com) or provided in conjunction with such TI products. TI's provision of these resources does not expand or otherwise alter TI's applicable warranties or warranty disclaimers for TI products.

TI objects to and rejects any additional or different terms you may have proposed.

Mailing Address: Texas Instruments, Post Office Box 655303, Dallas, Texas 75265
Copyright © 2024, Texas Instruments Incorporated