

TPS6229x 2x2 DRVパッケージの1A降圧型コンバータ

1 特長

- 高効率 - 最高96%
- 出力電流: 最大1000mA
- V_{IN} が2.3V~6.0Vの広い電圧範囲により、リチウムイオン・バッテリーを使用可能
- 2.25MHzの固定周波数動作
- 軽負荷電流時のパワーセーブ・モード
- PWMモードでの出力電圧精度: $\pm 1.5\%$
- 固定出力電圧オプション
- 静止電流: 15 μ A(標準値)
- 100%デューティ・サイクル動作により低いドロップアウト電圧を実現
- 軽負荷時の電圧ポジショニング
- 2mmx2mmx0.8mmのWSON (6)パッケージ(DRV)で供給

2 アプリケーション

- 携帯電話/スマートフォン
- ワイヤレスLAN
- ポケットPC
- 低消費電力のDSP電源
- 携帯用メディア・プレーヤー
- ポイント・オブ・ロード(POL)アプリケーション

3 概要

TPS6229xデバイスは高効率の同期整流降圧型DC/DCコンバータで、バッテリー駆動の携帯アプリケーション用に最適化されています。単一のリチウムイオン電池から、最大1000mAの出力電流を供給します。

入力電圧範囲は2.3V~6.0Vで、拡張電圧範囲によりバッテリーをサポートし、携帯電話などの携帯機器向け電源の用途に理想的です。

TPS6229xデバイスは、2.25MHzの固定スイッチング周波数で動作し、軽負荷電流時にはパワーセーブ・モードの動作に切り替わり、広い負荷電流範囲にわたって高効率を維持します。

パワーセーブ・モードは、低出力電圧リップルに最適化されています。さらに低ノイズが要求されるアプリケーションの場合、MODEピンをHIGHにすることで、強制的に固定周波数パルス幅変調(PWM)モードに設定できます。シャットダウン・モードでは、電流消費が1 μ A未満に低減します。TPS6229xデバイスは小さなインダクタとコンデンサを使用できるため、ソリューションを小型化できます。

TPS6229xデバイスはフリーエア状態で、-40°C~85°Cの温度範囲で動作します。このデバイスは、2mmx2mmの6ピンWSONパッケージ(DRV)で供給されます。

製品情報(1)

型番	パッケージ	本体サイズ(公称)
TPS6229x	SON (6)	2.00mmx2.00mm

(1) 提供されているすべてのパッケージについては、巻末の注文情報を参照してください。

代表的なアプリケーションの回路図

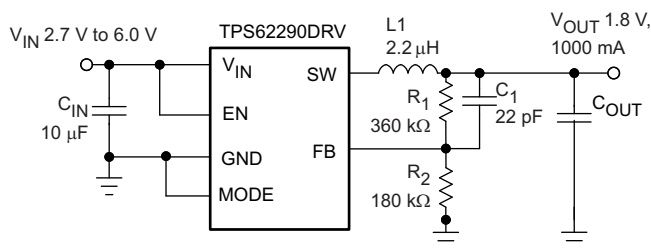

効率と出力電流との関係

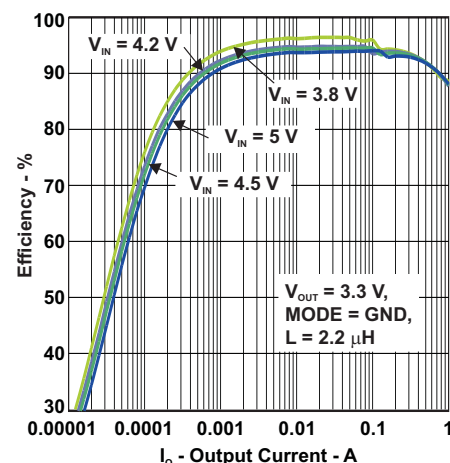

目次

1	特長	1	8.4	Device Functional Modes	9
2	アプリケーション	1	9	Application and Implementation	11
3	概要	1	9.1	Application Information	11
4	改訂履歴	2	9.2	Typical Application	11
5	Device Comparison Table	3	9.3	System Examples	17
6	Pin Configuration and Functions	3	10	Power Supply Recommendations	18
7	Specifications	4	11	Layout	18
7.1	Absolute Maximum Ratings	4	11.1	Layout Guidelines	18
7.2	ESD Ratings	4	11.2	Layout Example	18
7.3	Recommended Operating Conditions	4	12	デバイスおよびドキュメントのサポート	19
7.4	Thermal Information	4	12.1	デバイス・サポート	19
7.5	Electrical Characteristics	5	12.2	関連リンク	19
7.6	Typical Characteristics	6	12.3	コミュニティ・リソース	19
8	Detailed Description	7	12.4	商標	19
8.1	Overview	7	12.5	静電気放電に関する注意事項	19
8.2	Functional Block Diagram	7	12.6	Glossary	19
8.3	Feature Description	7	13	メカニカル、パッケージ、および注文情報	19

4 改訂履歴

資料番号末尾の英字は改訂を表しています。その改訂履歴は英語版に準じています。

Revision F (January 2016) から Revision G に変更	Page
• Changed Equation 3 operator from \times to $+$ in correcting the I_{Lmax} formula.	12
• Added cross references to the Third-party Products disclaimer.	12

Revision E (September 2015) から Revision F に変更	Page
• Added Device Comparison Table	3

Revision D (November 2009) から Revision E に変更	Page
• 「ピン構成および機能」セクション、「ESD定格」表、「機能説明」セクション、「デバイスの機能モード」セクション、「アプリケーションと実装」セクション、「電源に関する推奨事項」セクション、「レイアウト」セクション、「デバイスおよびドキュメントのサポート」セクション、「メカニカル、パッケージ、および注文情報」セクション 追加	1

5 Device Comparison Table

PART NUMBER	OUTPUT VOLTAGE ⁽¹⁾	DEVICE MARKING ⁽²⁾
TPS62290	Adjustable	BYN
TPS62291	3.3 V fixed	CFY
TPS62293	1.8 V fixed	CFD

- (1) Contact TI for other fixed output voltage options
 (2) For the most current package and ordering information, see [メカニカル、パッケージ、および注文情報](#), or see the TI website at www.ti.com

6 Pin Configuration and Functions

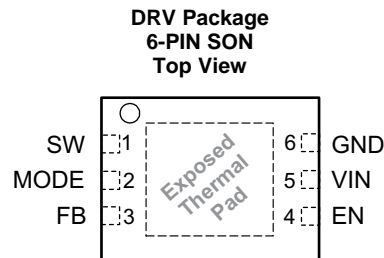

Pin Functions

PIN		TYPE	DESCRIPTION
NAME	NO.		
EN	4	IN	This is the enable pin of the device. Pulling this pin to low forces the device into shutdown mode. Pulling this pin to high enables the device. This pin must be terminated.
FB	3	IN	Feedback pin for the internal regulation loop. Connect the external resistor divider to this pin. In case of fixed output voltage option, connect this pin directly to the output capacitor
GND	6	PWR	GND supply pin
MODE	2	IN	MODE pin = High forces the device to operate in fixed-frequency PWM mode. Mode pin = Low enables the power save mode with automatic transition from PFM mode to fixed-frequency PWM mode.
SW	1	OUT	This is the switch pin and is connected to the internal MOSFET switches. Connect the external inductor between this terminal and the output capacitor.
VIN	5	PWR	V_{IN} power supply pin.
Exposed Thermal Pad			Connect the exposed thermal pad to GND.

7 Specifications

7.1 Absolute Maximum Ratings

Over operating free-air temperature range (unless otherwise noted)⁽¹⁾

	MIN	MAX	UNIT
V_{IN} Input voltage range ⁽²⁾	-0.3	7	V
Voltage range at EN, MODE	-0.3	$V_{IN} + 0.3, \leq 7$	
Voltage at SW	-0.3	7	
Peak output current	Internally limited		A
T_J Maximum operating junction temperature	-40	125	°C
T_{stg} Storage temperature	-65	150	

- (1) Stresses beyond those listed under *Absolute Maximum Ratings* may cause permanent damage to the device. These are stress ratings only and functional operation of the device at these or any other conditions beyond those indicated under *Recommended Operating Conditions* is not implied. Exposure to absolute-maximum-rated conditions for extended periods may affect device reliability.
- (2) All voltage values are with respect to network ground terminal.

7.2 ESD Ratings

	VALUE	UNIT
$V_{(ESD)}$ Electrostatic discharge	Human body model (HBM), per ANSI/ESDA/JEDEC JS-001 ⁽¹⁾	±2000
	Charged-device model (CDM), per JEDEC specification JESD22-C101 ⁽²⁾	±1000

- (1) JEDEC document JEP155 states that 500-V HBM allows safe manufacturing with a standard ESD control process.
- (2) JEDEC document JEP157 states that 250-V CDM allows safe manufacturing with a standard ESD control process.

7.3 Recommended Operating Conditions

	MIN	NOM	MAX	UNIT
V_{IN} Supply voltage	2.3		6	V
Output voltage range for adjustable voltage	0.6		V_{IN}	V
T_A Operating ambient temperature	-40		85	°C
T_J Operating junction temperature	-40		125	°C

7.4 Thermal Information

THERMAL METRIC ⁽¹⁾	TPS6229x	UNIT
	DRV (SON)	
	6 PINS	
$R_{\theta JA}$ Junction-to-ambient thermal resistance	67.8	°C/W
$R_{\theta JC(top)}$ Junction-to-case (top) thermal resistance	88.6	°C/W
$R_{\theta JB}$ Junction-to-board thermal resistance	37.2	°C/W
Ψ_{JT} Junction-to-top characterization parameter	2	°C/W
Ψ_{JB} Junction-to-board characterization parameter	37.6	°C/W
$R_{\theta JC(bot)}$ Junction-to-case (bottom) thermal resistance	7.9	°C/W

- (1) For more information about traditional and new thermal metrics, see the *Semiconductor and IC Package Thermal Metrics* application report, [SPRA953](#).

7.5 Electrical Characteristics

Over full operating ambient temperature range, typical values are at $T_A = 25^\circ\text{C}$. Unless otherwise noted, specifications apply for condition $V_{IN} = EN = 3.6\text{ V}$. External components $C_{IN} = 4.7\ \mu\text{F}$ 0603, $C_{OUT} = 10\ \mu\text{F}$ 0603, $L = 2.2\ \mu\text{H}$, refer to parameter measurement information.

PARAMETER		TEST CONDITIONS	MIN	TYP	MAX	UNIT
SUPPLY						
V_{IN}	Input voltage		2.3		6	V
I_{OUT}	Output current	$V_{IN} 2.7\text{ V to }6\text{ V}$			1000	mA
		$V_{IN} 2.5\text{ V to }2.7\text{ V}$			600	
		$V_{IN} 2.3\text{ V to }2.5\text{ V}$			300	
I_Q	Operating quiescent current	$I_{OUT} = 0\text{ mA}$, PFM mode enabled (MODE = GND) device not switching, See ⁽¹⁾		15		μA
		$I_{OUT} = 0\text{ mA}$, switching with no load (MODE = V_{IN}) PWM operation, $V_{OUT} = 1.8\text{ V}$, $V_{IN} = 3\text{ V}$		3.8		mA
I_{SD}	Shutdown current	EN = GND		0.1	1	μA
UVLO	Undervoltage lockout threshold	Falling		1.85		V
		Rising		1.95		
ENABLE, MODE						
V_{IH}	High level input voltage, EN, MODE	$2.3\text{ V} \leq V_{IN} \leq 6\text{ V}$	1		V_{IN}	V
V_{IL}	Low level input voltage, EN, MODE	$2.3\text{ V} \leq V_{IN} \leq 6\text{ V}$	0		0.4	V
I_{IN}	Input bias current, EN, MODE	EN, MODE = GND or V_{IN}		0.01	1	μA
POWER SWITCH						
$R_{DS(on)}$	High side MOSFET on-resistance	$V_{IN} = V_{GS} = 3.6\text{ V}$, $T_A = 25^\circ\text{C}$		240	480	m Ω
	Low side MOSFET on-resistance			185	380	
I_{LIMF}	Forward current limit MOSFET high-side and low side	$V_{IN} = V_{GS} = 3.6\text{ V}$	1.19	1.4	1.68	A
T_{SD}	Thermal shutdown	Increasing junction temperature		140		$^\circ\text{C}$
	Thermal shutdown hysteresis	Decreasing junction temperature		20		
OSCILLATOR						
f_{SW}	Oscillator frequency	$2.3\text{ V} \leq V_{IN} \leq 6\text{ V}$	2.0	2.25	2.5	MHz
OUTPUT						
V_{OUT}	Adjustable output voltage range		0.6		V_I	V
V_{ref}	Reference voltage			600		mV
$V_{FB(PWM)}$	Feedback voltage PWM mode	MODE = V_{IN} , PWM operation, $2.3\text{ V} \leq V_{IN} \leq 6\text{ V}$, See ⁽²⁾	-1.5%	0%	1.5%	
$V_{FB(PFM)}$	Feedback voltage PFM mode	MODE = GND, device in PFM mode, ⁽¹⁾ +1% voltage positioning active, See ⁽¹⁾		1%		
	Load regulation			-0.5		%/A
$t_{Start\ Up}$	Start-up time	Time from active EN to reach 95% of V_{OUT}		500		μs
t_{Ramp}	V_{OUT} ramp-up time	Time to ramp from 5% to 95% of V_{OUT}		250		μs
I_{Ikg}	Leakage current into SW pin	$V_{IN} = 3.6\text{ V}$, $V_{IN} = V_{OUT} = V_{SW}$, EN = GND, See ⁽³⁾		0.1	1	μA

(1) In PFM mode, the internal reference voltage is set to typical $1.01 \times V_{ref}$. See the parameter measurement information.

(2) For $V_{IN} = V_{OUT} + 1.0\text{ V}$

(3) In fixed output voltage versions, the internal resistor divider network is disconnected from FB pin.

7.6 Typical Characteristics

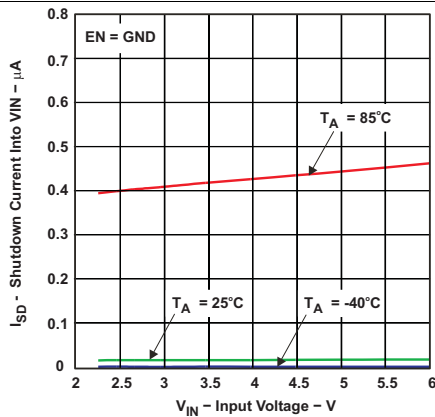

Figure 1. Shutdown Current Into VIN vs Input Voltage

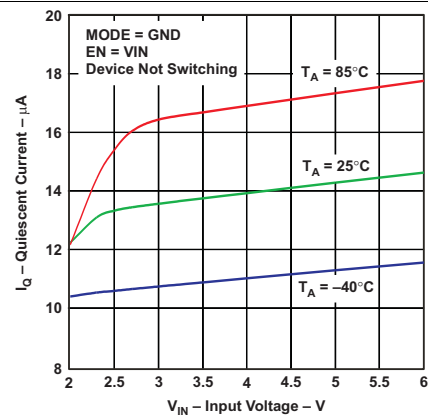

Figure 2. Quiescent Current vs Input Voltage

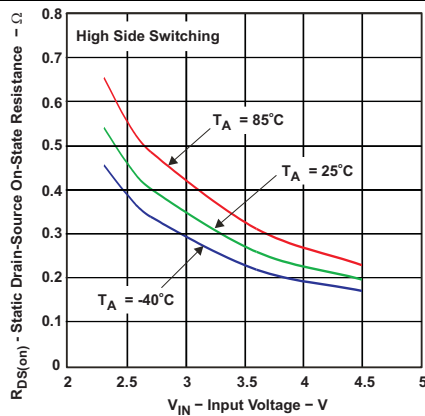

Figure 3. Static Drain-Source On-State Resistance vs Input Voltage

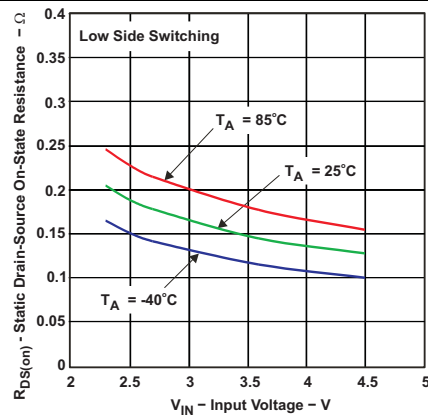

Figure 4. Static Drain-Source On-State Resistance vs Input Voltage

8 Detailed Description

8.1 Overview

The TPS6229x step down converters operate with typically 2.25-MHz fixed frequency pulse width modulation (PWM) mode at moderate to heavy load currents. At light load currents, the converters can automatically enter power save mode and operate then in pulse frequency modulation (PFM) mode.

During PWM operation, the converters use a unique fast response voltage mode controller scheme with input voltage feed-forward to achieve good line and load regulation allowing the use of small ceramic input and output capacitors. At the beginning of each clock cycle initiated by the clock signal, the high side MOSFET switch is turned on. The current flows now from the input capacitor via the high side MOSFET switch through the inductor to the output capacitor and load. During this phase, the current ramps up until the PWM comparator trips and the control logic will turn off the switch. The current limit comparator also turns off the switch in case the current limit of the high side MOSFET switch is exceeded. After a dead time preventing shoot through current, the low side MOSFET rectifier is turned on and the inductor current ramps down. The current flows now from the inductor to the output capacitor and to the load. It returns to the inductor through the low side MOSFET rectifier.

The next cycle is initiated by the clock signal again turning off the low side MOSFET rectifier and turning on the high side MOSFET switch.

8.2 Functional Block Diagram

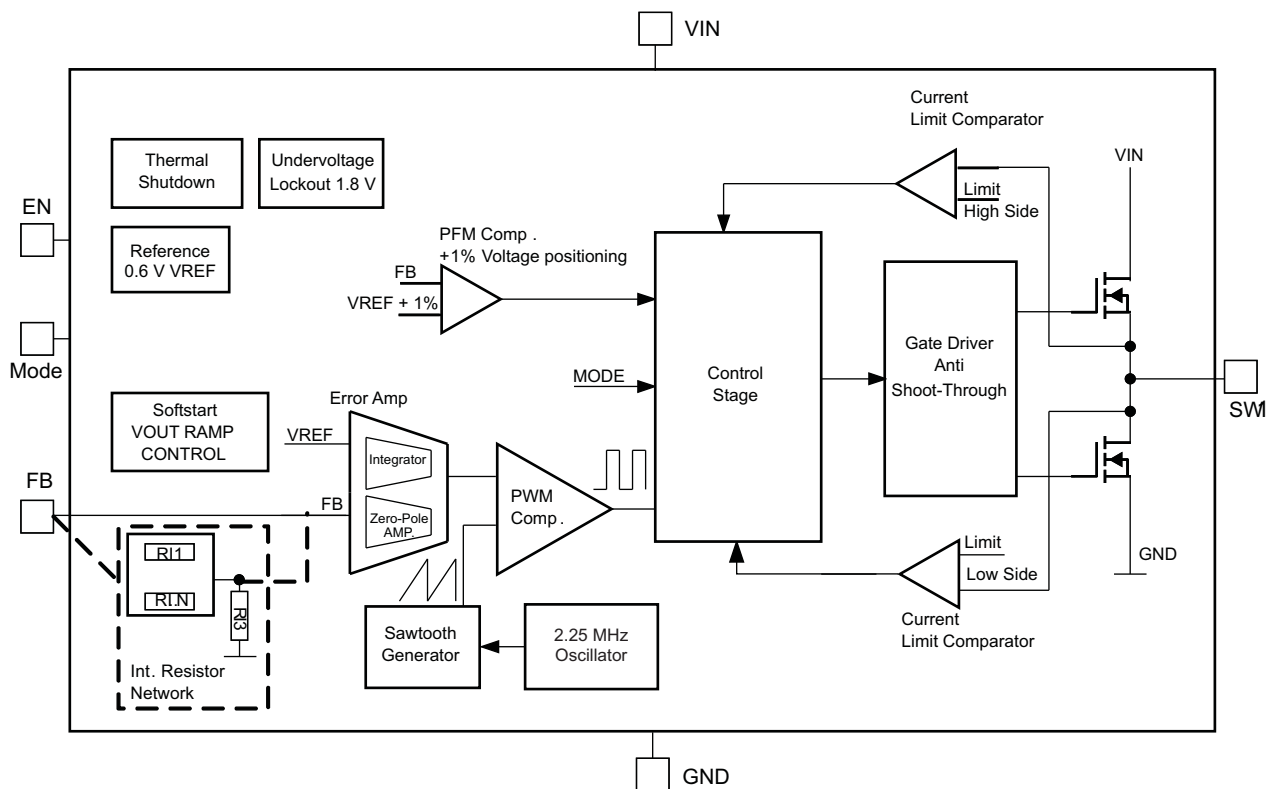

8.3 Feature Description

8.3.1 Dynamic Voltage Positioning

This feature reduces the voltage undershoots/overshoots at load steps from light to heavy load and vice versa. It is active in power save mode and regulates the output voltage 1% higher than the nominal value. This provides more headroom for both the voltage drop at a load step, and the voltage increase at a load throw-off.

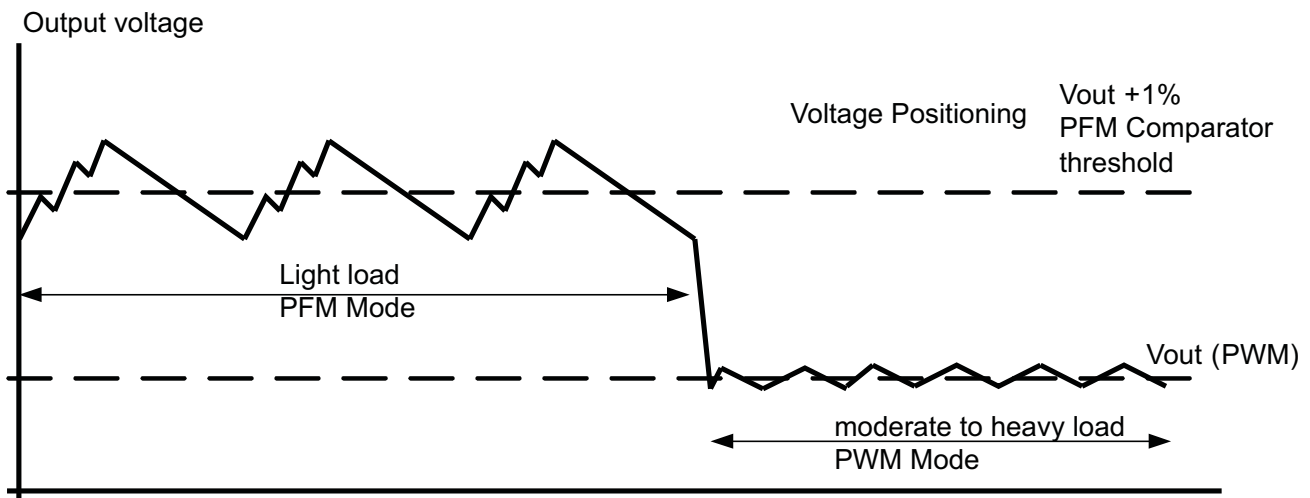
Feature Description (continued)

Figure 5. Power Save Mode Operation
8.3.2 Enable

The device is enabled by setting EN pin to high. During the start up time $t_{\text{start up}}$ the internal circuits are settled and the soft start circuit is activated. The EN input can be used to control power sequencing in a system with various DC/DC converters. The EN pin can be connected to the output of another converter, to drive the EN pin high and getting a sequencing of supply rails. With EN = GND, the device enters shutdown mode, in which all internal circuits are disabled. In fixed output voltage versions, the internal resistor divider network is disconnected from FB pin.

8.3.3 Mode Selection

The MODE pin allows mode selection between forced PWM mode and power save mode.

Connecting this pin to GND enables the power save mode with automatic transition between PWM and PFM mode. Pulling the MODE pin high forces the converter to operate in fixed frequency PWM mode even at light load currents. This allows simple filtering of the switching frequency for noise sensitive applications. In this mode, the efficiency is lower compared to the power save mode during light loads.

The condition of the MODE pin can be changed during operation and allows efficient power management by adjusting the operation mode of the converter to the specific system requirements.

8.3.4 Undervoltage Lockout

The undervoltage lockout circuit prevents the device from malfunctioning at low input voltages and from excessive discharge of the battery and disables the output stage of the converter. The undervoltage lockout threshold is typically 1.85 V with falling V_{IN} .

8.3.5 Thermal Shutdown

As soon as the junction temperature, T_J , exceeds 140°C (typical) the device goes into thermal shutdown. In this mode, the high side and low side MOSFETs are turned-off. The device continues its operation when the junction temperature falls below the thermal shutdown hysteresis.

8.4 Device Functional Modes

8.4.1 Soft-Start

The TPS6229x has an internal soft start circuit that controls the ramp up of the output voltage. The output voltage ramps up from 5% to 95% of its nominal value within typical 250 μ s. This limits the inrush current in the converter during ramp up and prevents possible input voltage drops when a battery or high impedance power source is used. The soft start circuit is enabled within the start up time $t_{Start\ Up}$.

8.4.2 Power Save Mode

The power save mode is enabled with MODE pin set to low level. If the load current decreases, the converter will enter power save mode operation automatically. During power save mode the converter skips switching and operates with reduced frequency in PFM mode with a minimum quiescent current to maintain high efficiency. The converter will position the output voltage typically +1% above the nominal output voltage. This voltage positioning feature minimizes voltage drops caused by a sudden load step.

The transition from PWM mode to PFM mode occurs once the inductor current in the low side MOSFET switch becomes zero, which indicates discontinuous conduction mode.

During the power save mode the output voltage is monitored with a PFM comparator. As the output voltage falls below the PFM comparator threshold of $V_{OUT\ nominal} + 1\%$, the device starts a PFM current pulse. The high side MOSFET switch will turn on and the inductor current ramps up. After the on-time expires, the switch is turned off and the low side MOSFET switch is turned on until the inductor current becomes zero.

The converter effectively delivers a current to the output capacitor and the load. If the load is below the delivered current, the output voltage will rise. If the output voltage is equal or higher than the PFM comparator threshold, the device stops switching and enters a sleep mode with typical 15 μ A current consumption.

If the output voltage is still below the PFM comparator threshold, a sequence of further PFM current pulses are generated until the PFM comparator threshold is reached. The converter starts switching again once the output voltage drops below the PFM comparator threshold.

With a fast single threshold comparator, the output voltage ripple during PFM mode operation can be kept small. The PFM pulse is time controlled, which allows to modify the charge transferred to the output capacitor by the value of the inductor. The resulting PFM output voltage ripple and PFM frequency depend in first order on the size of the output capacitor and the inductor value. Increasing output capacitor values and inductor values will minimize the output ripple. The PFM frequency decreases with smaller inductor values and increases with larger values.

The PFM mode is left and PWM mode entered in case the output current can not longer be supported in PFM mode. The power save mode can be disabled through the MODE pin set to high. The converter will then operate in fixed frequency PWM mode.

8.4.3 100% Duty Cycle Low Dropout Operation

The device starts to enter 100% duty cycle mode once the input voltage comes close to the nominal output voltage. In order to maintain the output voltage, the high side MOSFET switch is turned on 100% for one or more cycles.

With further decreasing V_{IN} the high side MOSFET switch is turned on completely. In this case, the converter offers a low input-to-output voltage difference. This is particularly useful in battery-powered applications to achieve longest operation time by taking full advantage of the whole battery voltage range.

The minimum input voltage to maintain regulation depends on the load current and output voltage, and can be calculated as:

$$V_{IN\ min} = V_{OUT\ max} + (I_{OUT\ max} \times (R_{DS(on)\ max} + R_L))$$

where

- $I_{OUT\ max}$ = Maximum output current plus inductor ripple current
- $R_{DS(on)\ max}$ = Maximum P-channel switch $R_{DS(on)}$
- R_L = DC resistance of the inductor
- $V_{OUT\ max}$ = Nominal output voltage plus maximum output voltage tolerance

(1)

Device Functional Modes (continued)

8.4.4 Short-Circuit Protection

The high side and low side MOSFET switches are short-circuit protected with maximum switch current equal to I_{LIMF} . The current in the switches is monitored by current limit comparators. Once the current in the high side MOSFET switch exceeds the threshold of its current limit comparator, it turns off and the low side MOSFET switch is activated to ramp down the current in the inductor and high side MOSFET switch. The high side MOSFET switch can only turn on again, once the current in the low side MOSFET switch has decreased below the threshold of its current limit comparator.

9 Application and Implementation

NOTE

Information in the following applications sections is not part of the TI component specification, and TI does not warrant its accuracy or completeness. TI's customers are responsible for determining suitability of components for their purposes. Customers should validate and test their design implementation to confirm system functionality.

9.1 Application Information

The TPS6229x devices are high-efficiency synchronous step-down DC/DC converters featuring power save mode or 2.25-MHz fixed frequency operation.

9.2 Typical Application

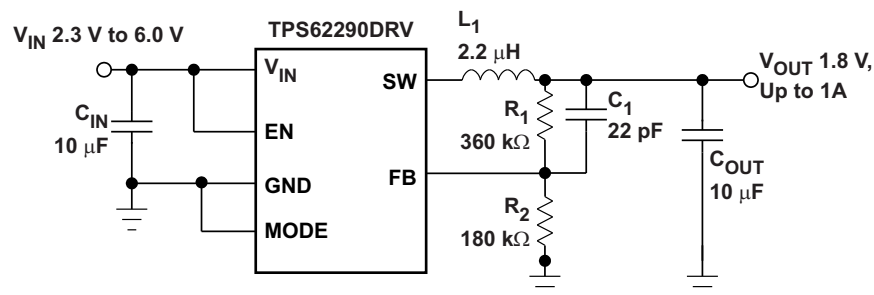

Figure 6. TPS62290DRV Adjustable 1.8 V

9.2.1 Design Requirements

The design guideline provides a component selection to operate the device within the recommended operating condition.

Table 1 shows the list of components for the Application Characteristic Curves.

Table 1. List of Components

COMPONENT REFERENCE	PART NUMBER	MANUFACTURER ⁽¹⁾	VALUE
C _{IN}	GRM188R60J106M	Murata	10 μF, 6.3 V. X5R Ceramic
C _{OUT}	GRM188R60J106M	Murata	10 μF, 6.3 V. X5R Ceramic
C ₁		Murata	22 pF, COG Ceramic
L ₁	LPS3015	Coilcraft	2.2 μH, 110 mΩ
R ₁ , R ₂	Values depending on the programmed output voltage		

(1) See [Third-party Products disclaimer](#)

9.2.2 Detailed Design Procedure

9.2.2.1 Output Voltage Setting

The output voltage can be calculated to:

$$V_{OUT} = V_{REF} \times \left(1 + \frac{R_1}{R_2} \right) \text{ with an internal reference voltage } V_{REF} \text{ typical } 0.6 \text{ V.}$$

To minimize the current through the feedback divider network, R₂ should be 180 kΩ or 360 kΩ. The sum of R₁ and R₂ should not exceed ~1MΩ, to keep the network robust against noise.

An external feed forward capacitor C₁ is required for optimum load transient response. The value of C₁ should be in the range between 22 pF and 33 pF.

Route the FB line away from noise sources, such as the inductor or the SW line.

9.2.2.2 Output Filter Design (Inductor and Output Capacitor)

The TPS6229x is designed to operate with inductors in the range of 1.5 μH to 4.7 μH and with output capacitors in the range of 4.7 μF to 22 μF . The part is optimized for operation with a 2.2- μH inductor and 10- μF output capacitor.

Larger or smaller inductor values can be used to optimize the performance of the device for specific operation conditions. For stable operation, the L and C values of the output filter may not fall below 1- μH effective inductance and 3.5- μF effective capacitance.

9.2.2.2.1 Inductor Selection

The inductor value has a direct effect on the ripple current. The selected inductor has to be rated for its DC resistance and saturation current. The inductor ripple current (ΔI_L) decreases with higher inductance and increases with higher V_{IN} or V_{OUT} .

The inductor selection has also impact on the output voltage ripple in PFM mode. Higher inductor values will lead to lower output voltage ripple and higher PFM frequency, lower inductor values will lead to a higher output voltage ripple but lower PFM frequency.

Equation 2 calculates the maximum inductor current under static load conditions. The saturation current of the inductor should be rated higher than the maximum inductor current as calculated with Equation 3. This is recommended because during heavy load transient the inductor current will rise above the calculated value.

$$\Delta I_L = V_{\text{OUT}} \times \frac{1 - \frac{V_{\text{OUT}}}{V_{\text{IN}}}}{L \times f} \quad (2)$$

$$I_{L\text{max}} = I_{\text{OUTmax}} + \frac{\Delta I_L}{2}$$

where

- f = Switching frequency (2.25 MHz typical)
 - L = Inductor value
 - ΔI_L = Peak-to-peak inductor ripple current
 - $I_{L\text{max}}$ = Maximum inductor current
- (3)

A more conservative approach is to select the inductor current rating just for the maximum switch current of the corresponding converter.

Accepting larger values of ripple current allows the use of low inductance values, but results in higher output voltage ripple, greater core losses, and lower output current capability.

The total losses of the coil have a strong impact on the efficiency of the DC/DC conversion and consist of both the losses in the DC resistance $R_{(\text{DC})}$ and the following frequency-dependent components:

- The losses in the core material (magnetic hysteresis loss, especially at high switching frequencies)
- Additional losses in the conductor from the skin effect (current displacement at high frequencies)
- Magnetic field losses of the neighboring windings (proximity effect)
- Radiation losses

Table 2. List of Inductors

DIMENSIONS [mm ³]	INDUCTOR TYPE	SUPPLIER ⁽¹⁾
3 x 3 x 1.5	LPS3015	Coilcraft
3 x 3 x 1.5	LQH3NPN2R2NM0	MURATA
3.2 x 2.6 x 1.2	MIPSA3226D2R2	FDK

(1) See [Third-party Products disclaimer](#)

9.2.2.2.2 Output Capacitor Selection

The advanced fast-response voltage mode control scheme of the TPS6229x allows the use of tiny ceramic capacitors. Ceramic capacitors with low ESR values have the lowest output voltage ripple and are recommended. The output capacitor requires either an X7R or X5R dielectric. Y5V and Z5U dielectric capacitors, aside from their wide variation in capacitance over temperature, become resistive at high frequencies.

At nominal load current, the device operates in PWM mode and the RMS ripple current is calculated as:

$$I_{\text{RMS}_{\text{C}_{\text{OUT}}}} = V_{\text{OUT}} \times \frac{1 - \frac{V_{\text{OUT}}}{V_{\text{IN}}}}{L \times f} \times \left(\frac{1}{2 \times \sqrt{3}} \right) \quad (4)$$

At nominal load current, the device operates in PWM mode and the overall output voltage ripple is the sum of the voltage spike caused by the output capacitor ESR plus the voltage ripple caused by charging and discharging the output capacitor:

$$\Delta V_{\text{OUT}} = V_{\text{OUT}} \times \frac{1 - \frac{V_{\text{OUT}}}{V_{\text{IN}}}}{L \times f} \times \left(\frac{1}{8 \times C_{\text{OUT}} \times f} + \text{ESR} \right) \quad (5)$$

At light load currents the converter operates in power save mode and the output voltage ripple is dependent on the output capacitor and inductor value. Larger output capacitor and inductor values minimize the voltage ripple in PFM mode and tighten DC output accuracy in PFM mode.

9.2.2.2.3 Input Capacitor Selection

The buck converter has a natural pulsating input current; therefore, a low ESR input capacitor is required for best input voltage filtering and minimizing the interference with other circuits caused by high input voltage spikes. For most applications, a 10- μF ceramic capacitor is recommended. The input capacitor can be increased without any limit for better input voltage filtering.

Take care when using only small ceramic input capacitors. When a ceramic capacitor is used at the input and the power is being supplied through long wires, such as from a wall adapter, a load step at the output or V_{IN} step on the input can induce ringing at the V_{IN} pin. The ringing can couple to the output and be mistaken as loop instability or could even damage the part by exceeding the maximum ratings.

Table 3. List of Capacitor

CAPACITANCE	TYPE	SIZE	SUPPLIER ⁽¹⁾
10 μF	GRM188R60J106M69D	0603 1.6 × 0.8 × 0.8 mm ³	Murata

(1) See [Third-party Products disclaimer](#)

9.2.3 Application Curves

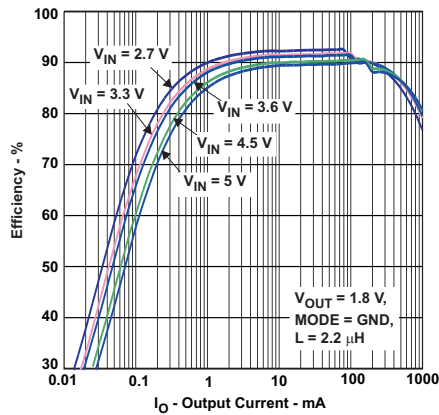

Figure 7. Efficiency (Power Save Mode) vs Output Current, $V_{OUT} = 1.8\text{ V}$

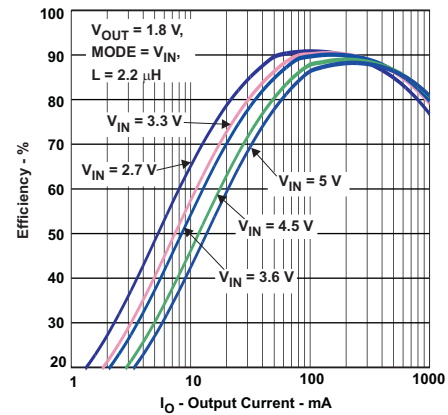

Figure 8. Efficiency (Forced PWM Mode) vs Output Current, $V_{OUT} = 1.8\text{ V}$

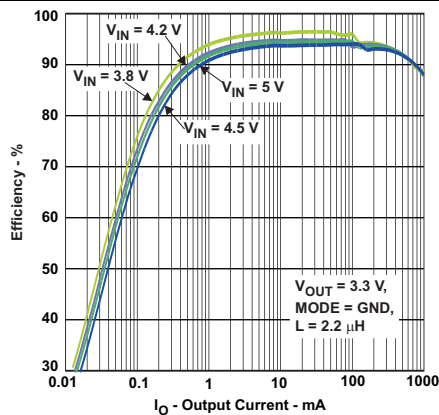

Figure 9. Efficiency (Power Save Mode) vs Output Current, $V_{OUT} = 3.3\text{ V}$

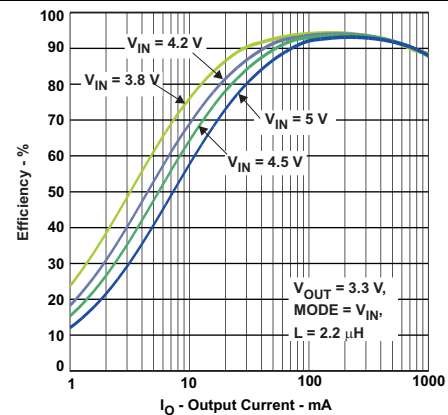

Figure 10. Efficiency (Forced PWM Mode) vs Output Current, $V_{OUT} = 3.3\text{ V}$

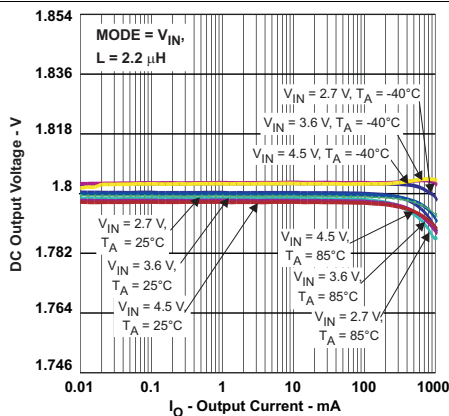

Figure 11. Output Voltage Accuracy (1.8-V Forced PWM Mode) vs Output Current

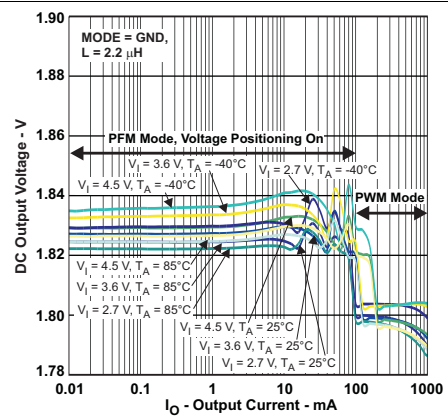

Figure 12. Output Voltage Accuracy (1.8-V Power Save Mode) vs Output Current

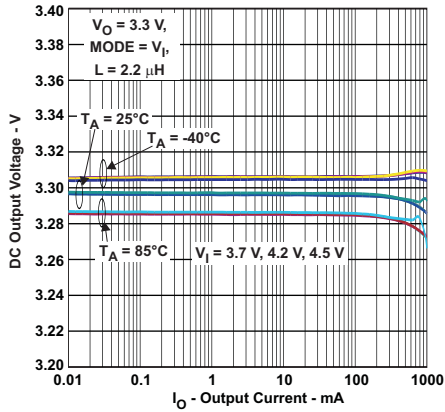

Figure 13. Output Voltage Accuracy 3.3-V Forced PWM Mode vs Output Current

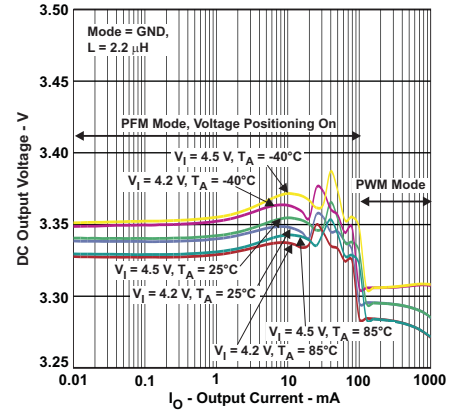

Figure 14. Output Voltage Accuracy 3.3-V Power Save Mode vs Output Current

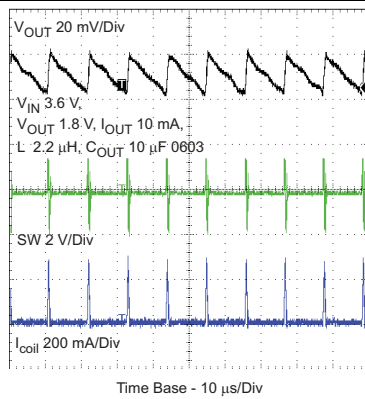

Figure 15. Typical Operation vs PFM Mode

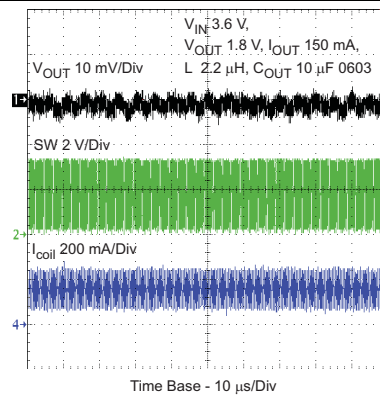

Figure 16. Typical Operation vs PWM Mode

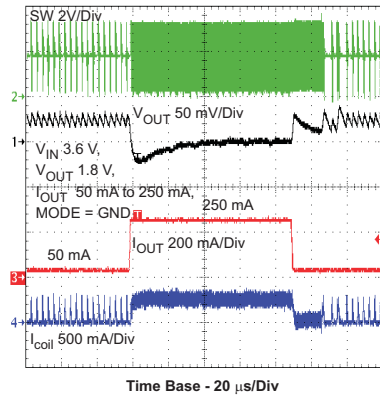

Figure 17. PFM Load Transient

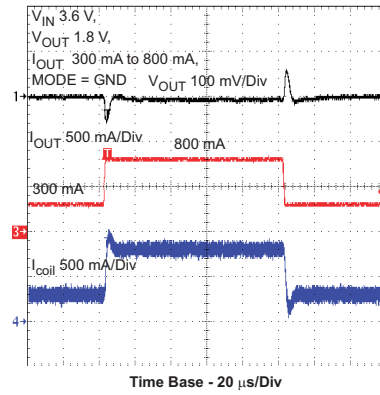

Figure 18. PFM Line Transient

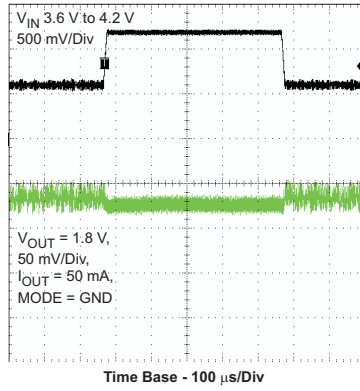

Figure 19. PWM Load Transient

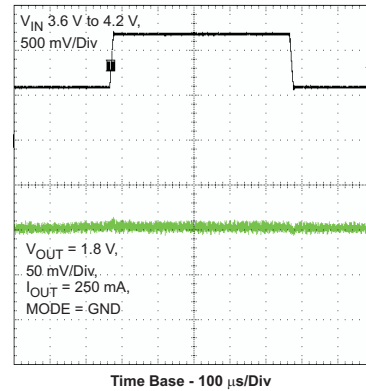

Figure 20. PWM Line Transient

9.3 System Examples

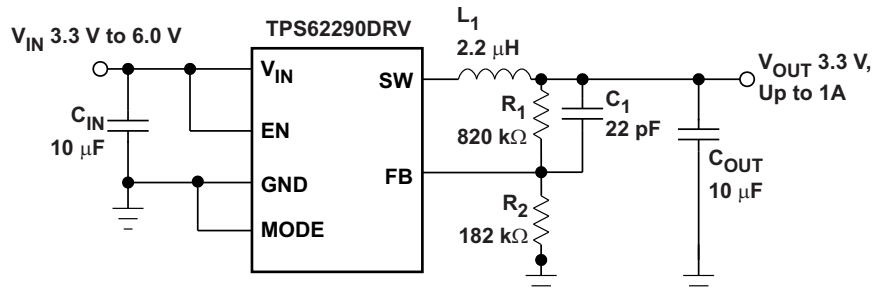

Figure 21. TPS62290DRV Adjustable 3.3 V

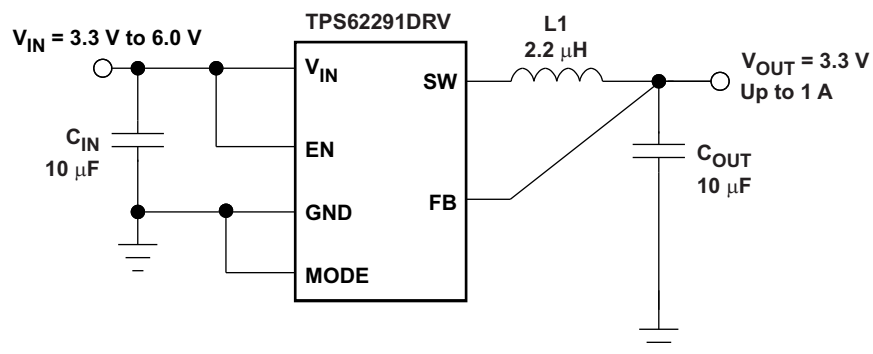

Figure 22. TPS62291DRV Fixed 3.3 V

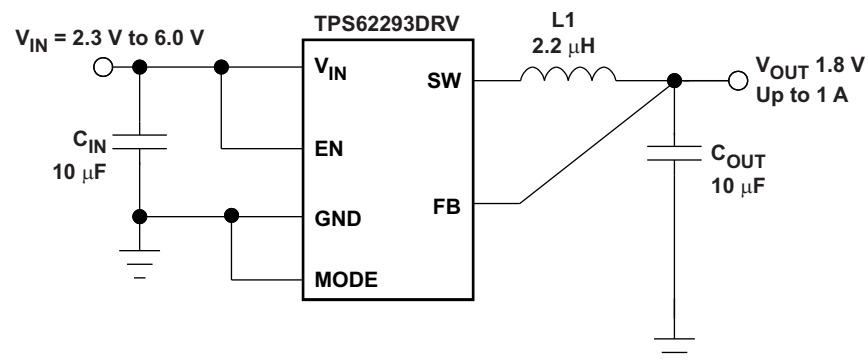

Figure 23. TPS62291DRV Fixed 1.8 V

10 Power Supply Recommendations

The TPS6229x devices have no special requirements for its input power supply. The input power supply's output current needs to be rated according to the supply voltage, output voltage and output current of the TPS6229x.

11 Layout

11.1 Layout Guidelines

As for all switching power supplies, the layout is an important step in the design. Proper function of the device demands careful attention to PCB layout. Care must be taken in board layout to get the specified performance. If the layout is not carefully done, the regulator could show poor line and/or load regulation, stability issues as well as EMI problems. It is critical to provide a low inductance, impedance ground path. Therefore, use wide and short traces for the main current paths. The input capacitor should be placed as close as possible to the IC pins as well as the inductor and output capacitor.

Connect the GND pin of the device to the exposed thermal pad of the PCB and use this pad as a star point. Use a common power GND node and a different node for the signal GND to minimize the effects of ground noise. Connect these ground nodes together to the exposed thermal pad (star point) underneath the IC. Keep the common path to the GND pin, which returns the small signal components and the high current of the output capacitors as short as possible to avoid ground noise. The FB line should be connected right to the output capacitor and routed away from noisy components and traces (for example, SW line).

11.2 Layout Example

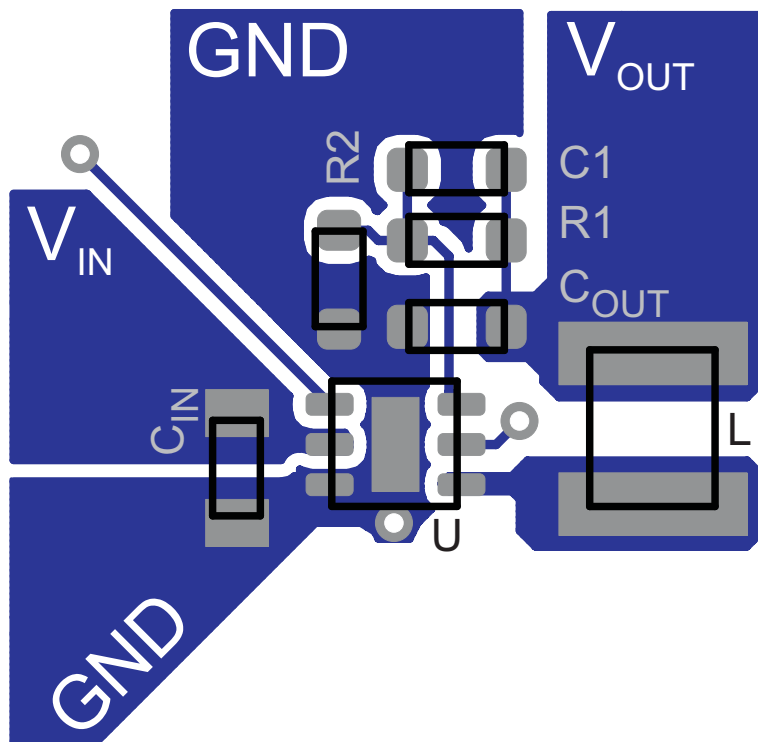

Figure 24. Layout Diagram

12 デバイスおよびドキュメントのサポート

12.1 デバイス・サポート

12.1.1 デベロッパー・ネットワークの製品に関する免責事項

デベロッパー・ネットワークの製品またはサービスに関するTIの出版物は、単独またはTIの製品、サービスと一緒に提供される場合に関係なく、デベロッパー・ネットワークの製品またはサービスの適合性に関する是認、デベロッパー・ネットワークの製品またはサービスの是認の表明を意味するものではありません。

12.2 関連リンク

次の表に、クイック・アクセス・リンクを示します。カテゴリには、技術資料、サポートおよびコミュニティ・リソース、ツールとソフトウェア、およびサンプル注文またはご購入へのクイック・アクセスが含まれます。

表 4. 関連リンク

製品	プロダクト・フォルダ	サンプルとご購入	技術資料	ツールとソフトウェア	サポートとコミュニティ
TPS62290	ここをクリック	ここをクリック	ここをクリック	ここをクリック	ここをクリック
TPS62291	ここをクリック	ここをクリック	ここをクリック	ここをクリック	ここをクリック
TPS62293	ここをクリック	ここをクリック	ここをクリック	ここをクリック	ここをクリック

12.3 コミュニティ・リソース

The following links connect to TI community resources. Linked contents are provided "AS IS" by the respective contributors. They do not constitute TI specifications and do not necessarily reflect TI's views; see TI's [Terms of Use](#).

TI E2E™ オンライン・コミュニティ *TIのE2E (Engineer-to-Engineer)* コミュニティ。エンジニア間の共同作業を促進するために開設されたものです。e2e.ti.comでは、他のエンジニアに質問し、知識を共有し、アイデアを検討して、問題解決に役立てることができます。

設計サポート *TIの設計サポート* 役に立つE2Eフォーラムや、設計サポート・ツールをすばやく見つけることができます。技術サポート用の連絡先情報も参照できます。

12.4 商標

E2E is a trademark of Texas Instruments.
All other trademarks are the property of their respective owners.

12.5 静電気放電に関する注意事項



これらのデバイスは、限定的なESD(静電破壊)保護機能を内蔵しています。保存時または取り扱い時は、MOSゲートに対する静電破壊を防止するために、リード線同士をショートさせておくか、デバイスを導電フォームに入れる必要があります。

12.6 Glossary

[SLYZ022](#) — *TI Glossary*.

This glossary lists and explains terms, acronyms, and definitions.

13 メカニカル、パッケージ、および注文情報

以降のページには、メカニカル、パッケージ、および注文に関する情報が記載されています。この情報は、そのデバイスについて利用可能な最新のデータです。このデータは予告なく変更されることがあり、ドキュメントが改訂される場合もあります。本データシートのブラウザ版を使用されている場合は、画面左側の説明をご覧ください。

PACKAGING INFORMATION

Orderable Device	Status (1)	Package Type	Package Drawing	Pins	Package Qty	Eco Plan (2)	Lead finish/ Ball material (6)	MSL Peak Temp (3)	Op Temp (°C)	Device Marking (4/5)	Samples
TPS62290DRVR	ACTIVE	WSON	DRV	6	3000	RoHS & Green	NIPDAU NIPDAUAG	Level-1-260C-UNLIM	-40 to 85	BYN	Samples
TPS62290DRVVT	ACTIVE	WSON	DRV	6	250	RoHS & Green	NIPDAU NIPDAUAG	Level-1-260C-UNLIM	-40 to 85	BYN	Samples
TPS62290DRVVG4	ACTIVE	WSON	DRV	6	250	RoHS & Green	NIPDAU	Level-1-260C-UNLIM	-40 to 85	BYN	Samples
TPS62291DRVR	ACTIVE	WSON	DRV	6	3000	RoHS & Green	NIPDAU	Level-1-260C-UNLIM	-40 to 85	CFY	Samples
TPS62291DRVVT	ACTIVE	WSON	DRV	6	250	RoHS & Green	NIPDAU	Level-1-260C-UNLIM	-40 to 85	CFY	Samples
TPS62293DRVR	ACTIVE	WSON	DRV	6	3000	RoHS & Green	NIPDAU	Level-1-260C-UNLIM	-40 to 85	CFD	Samples
TPS62293DRVVG4	ACTIVE	WSON	DRV	6	3000	RoHS & Green	NIPDAU	Level-1-260C-UNLIM	-40 to 85	CFD	Samples
TPS62293DRVVT	ACTIVE	WSON	DRV	6	250	RoHS & Green	NIPDAU	Level-1-260C-UNLIM	-40 to 85	CFD	Samples

(1) The marketing status values are defined as follows:

ACTIVE: Product device recommended for new designs.

LIFEBUY: TI has announced that the device will be discontinued, and a lifetime-buy period is in effect.

NRND: Not recommended for new designs. Device is in production to support existing customers, but TI does not recommend using this part in a new design.

PREVIEW: Device has been announced but is not in production. Samples may or may not be available.

OBSOLETE: TI has discontinued the production of the device.

(2) **RoHS:** TI defines "RoHS" to mean semiconductor products that are compliant with the current EU RoHS requirements for all 10 RoHS substances, including the requirement that RoHS substance do not exceed 0.1% by weight in homogeneous materials. Where designed to be soldered at high temperatures, "RoHS" products are suitable for use in specified lead-free processes. TI may reference these types of products as "Pb-Free".

RoHS Exempt: TI defines "RoHS Exempt" to mean products that contain lead but are compliant with EU RoHS pursuant to a specific EU RoHS exemption.

Green: TI defines "Green" to mean the content of Chlorine (Cl) and Bromine (Br) based flame retardants meet JS709B low halogen requirements of <=1000ppm threshold. Antimony trioxide based flame retardants must also meet the <=1000ppm threshold requirement.

(3) MSL, Peak Temp. - The Moisture Sensitivity Level rating according to the JEDEC industry standard classifications, and peak solder temperature.

(4) There may be additional marking, which relates to the logo, the lot trace code information, or the environmental category on the device.

(5) Multiple Device Markings will be inside parentheses. Only one Device Marking contained in parentheses and separated by a "~" will appear on a device. If a line is indented then it is a continuation of the previous line and the two combined represent the entire Device Marking for that device.

⁽⁶⁾ Lead finish/Ball material - Orderable Devices may have multiple material finish options. Finish options are separated by a vertical ruled line. Lead finish/Ball material values may wrap to two lines if the finish value exceeds the maximum column width.

Important Information and Disclaimer:The information provided on this page represents TI's knowledge and belief as of the date that it is provided. TI bases its knowledge and belief on information provided by third parties, and makes no representation or warranty as to the accuracy of such information. Efforts are underway to better integrate information from third parties. TI has taken and continues to take reasonable steps to provide representative and accurate information but may not have conducted destructive testing or chemical analysis on incoming materials and chemicals. TI and TI suppliers consider certain information to be proprietary, and thus CAS numbers and other limited information may not be available for release.

In no event shall TI's liability arising out of such information exceed the total purchase price of the TI part(s) at issue in this document sold by TI to Customer on an annual basis.

OTHER QUALIFIED VERSIONS OF TPS62290, TPS62293 :

- Automotive : [TPS62290-Q1](#), [TPS62293-Q1](#)

NOTE: Qualified Version Definitions:

- Automotive - Q100 devices qualified for high-reliability automotive applications targeting zero defects

TAPE AND REEL INFORMATION

QUADRANT ASSIGNMENTS FOR PIN 1 ORIENTATION IN TAPE

*All dimensions are nominal

Device	Package Type	Package Drawing	Pins	SPQ	Reel Diameter (mm)	Reel Width W1 (mm)	A0 (mm)	B0 (mm)	K0 (mm)	P1 (mm)	W (mm)	Pin1 Quadrant
TPS62290DRVR	WSO	DRV	6	3000	180.0	8.4	2.3	2.3	1.15	4.0	8.0	Q2
TPS62290DRVR	WSO	DRV	6	3000	179.0	8.4	2.2	2.2	1.2	4.0	8.0	Q2
TPS62290DRVT	WSO	DRV	6	250	179.0	8.4	2.2	2.2	1.2	4.0	8.0	Q2
TPS62290DRVT	WSO	DRV	6	250	180.0	8.4	2.3	2.3	1.15	4.0	8.0	Q2
TPS62291DRVR	WSO	DRV	6	3000	180.0	8.4	2.3	2.3	1.15	4.0	8.0	Q2
TPS62291DRVT	WSO	DRV	6	250	180.0	8.4	2.3	2.3	1.15	4.0	8.0	Q2
TPS62293DRVR	WSO	DRV	6	3000	180.0	8.4	2.3	2.3	1.15	4.0	8.0	Q2
TPS62293DRVR	WSO	DRV	6	3000	179.0	8.4	2.2	2.2	1.2	4.0	8.0	Q2
TPS62293DRVT	WSO	DRV	6	250	179.0	8.4	2.2	2.2	1.2	4.0	8.0	Q2

TAPE AND REEL BOX DIMENSIONS

*All dimensions are nominal

Device	Package Type	Package Drawing	Pins	SPQ	Length (mm)	Width (mm)	Height (mm)
TPS62290DRVR	WSON	DRV	6	3000	210.0	185.0	35.0
TPS62290DRVR	WSON	DRV	6	3000	200.0	183.0	25.0
TPS62290DRVT	WSON	DRV	6	250	200.0	183.0	25.0
TPS62290DRVT	WSON	DRV	6	250	210.0	185.0	35.0
TPS62291DRVR	WSON	DRV	6	3000	210.0	185.0	35.0
TPS62291DRVT	WSON	DRV	6	250	210.0	185.0	35.0
TPS62293DRVR	WSON	DRV	6	3000	210.0	185.0	35.0
TPS62293DRVR	WSON	DRV	6	3000	200.0	183.0	25.0
TPS62293DRVT	WSON	DRV	6	250	200.0	183.0	25.0

GENERIC PACKAGE VIEW

DRV 6

WSON - 0.8 mm max height

PLASTIC SMALL OUTLINE - NO LEAD



Images above are just a representation of the package family, actual package may vary.
Refer to the product data sheet for package details.

4206925/F

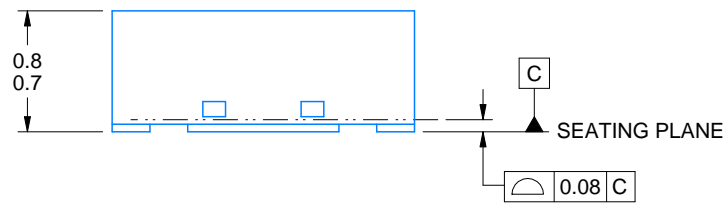

4222173/B 04/2018

NOTES:

1. All linear dimensions are in millimeters. Any dimensions in parenthesis are for reference only. Dimensioning and tolerancing per ASME Y14.5M.
2. This drawing is subject to change without notice.
3. The package thermal pad must be soldered to the printed circuit board for thermal and mechanical performance.

EXAMPLE STENCIL DESIGN

DRV0006A

WSON - 0.8 mm max height

PLASTIC SMALL OUTLINE - NO LEAD



SOLDER PASTE EXAMPLE
BASED ON 0.125 mm THICK STENCIL

EXPOSED PAD #7
88% PRINTED SOLDER COVERAGE BY AREA UNDER PACKAGE
SCALE:30X

4222173/B 04/2018

NOTES: (continued)

6. Laser cutting apertures with trapezoidal walls and rounded corners may offer better paste release. IPC-7525 may have alternate design recommendations.



4225563/A 12/2019

NOTES:

1. All linear dimensions are in millimeters. Any dimensions in parenthesis are for reference only. Dimensioning and tolerancing per ASME Y14.5M.
2. This drawing is subject to change without notice.
3. The package thermal pad must be soldered to the printed circuit board for thermal and mechanical performance.

EXAMPLE BOARD LAYOUT

DRV0006D

WSON - 0.8 mm max height

PLASTIC SMALL OUTLINE - NO LEAD



LAND PATTERN EXAMPLE
EXPOSED METAL SHOWN
SCALE:25X



SOLDER MASK DETAILS

4225563/A 12/2019

NOTES: (continued)

4. This package is designed to be soldered to a thermal pad on the board. For more information, see Texas Instruments literature number SLUA271 (www.ti.com/lit/sluea271).
5. Vias are optional depending on application, refer to device data sheet. If some or all are implemented, recommended via locations are shown.

EXAMPLE STENCIL DESIGN

DRV0006D

WSON - 0.8 mm max height

PLASTIC SMALL OUTLINE - NO LEAD



SOLDER PASTE EXAMPLE
BASED ON 0.125 mm THICK STENCIL

EXPOSED PAD #7
88% PRINTED SOLDER COVERAGE BY AREA UNDER PACKAGE
SCALE:30X

4225563/A 12/2019

NOTES: (continued)

6. Laser cutting apertures with trapezoidal walls and rounded corners may offer better paste release. IPC-7525 may have alternate design recommendations.

重要なお知らせと免責事項

TI は、技術データと信頼性データ(データシートを含みます)、設計リソース(リファレンス・デザインを含みます)、アプリケーションや設計に関する各種アドバイス、Web ツール、安全性情報、その他のリソースを、欠陥が存在する可能性のある「現状のまま」提供しており、商品性および特定目的に対する適合性の黙示保証、第三者の知的財産権の非侵害保証を含むいかなる保証も、明示的または黙示的にかかわらず拒否します。

これらのリソースは、TI 製品を使用する設計の経験を積んだ開発者への提供を意図したものです。(1) お客様のアプリケーションに適した TI 製品の選定、(2) お客様のアプリケーションの設計、検証、試験、(3) お客様のアプリケーションに該当する各種規格や、その他のあらゆる安全性、セキュリティ、規制、または他の要件への確実な適合に関する責任を、お客様のみが単独で負うものとし、

上記の各種リソースは、予告なく変更される可能性があります。これらのリソースは、リソースで説明されている TI 製品を使用するアプリケーションの開発の目的でのみ、TI はその使用をお客様に許諾します。これらのリソースに関して、他の目的で複製することや掲載することは禁止されています。TI や第三者の知的財産権のライセンスが付与されている訳ではありません。お客様は、これらのリソースを自身で使用した結果発生するあらゆる申し立て、損害、費用、損失、責任について、TI およびその代理人を完全に補償するものとし、TI は一切の責任を拒否します。

TI の製品は、[TI の販売条件](#)、または [ti.com](#) やかかる TI 製品の関連資料などのいずれかを通じて提供する適用可能な条項の下で提供されています。TI がこれらのリソースを提供することは、適用される TI の保証または他の保証の放棄の拡大や変更を意味するものではありません。

お客様がいかなる追加条項または代替条項を提案した場合でも、TI はそれらに異議を唱え、拒否します。

郵送先住所 : Texas Instruments, Post Office Box 655303, Dallas, Texas 75265
Copyright © 2024, Texas Instruments Incorporated