

# TPS56C215 3.8V~17V 入力、12A、同期整流降圧 SWIFT™ コンバータ

## 1 特長

- 13.5mΩ および 4.5mΩ の MOSFET を内蔵
- 12A の連続  $I_{OUT}$  をサポート
- 外部 5.0V バイアスなしで 4.5V のスタートアップ
- 温度範囲全体にわたって ±1% 精度の 0.6V 基準電圧
- 出力電圧範囲: 0.6V ~ 5.5V
- セラミック出力コンデンサに対応
- D-CAP3™ 制御モードによる高速過渡応答
- 厳しい出力電圧リップルに対応する強制連続導通モード(FCCM)、または、軽負荷時に効率を向上する自動スキップ Eco-mode のいずれかを選択可能
- $F_{SW}$  として 400kHz、800kHz、1.2MHz を選択可能
- プリバイアス出力への単調スタートアップ
- 2 つの調整可能な電流制限設定、ヒックアップ再起動機能付き
- 外部 5V バイアスによる効率向上 (オプション)
- 可変ソフトスタート、デフォルトのソフトスタート時間は 1ms
- 動作時接合部温度: -40°C ~ 150°C
- 小型 3.5mm × 3.5mm HotRod™ QFN パッケージ
- 8A [TPS568215](#) とピン互換
- WEBENCH® 設計ツールでのサポート

## 2 アプリケーション

- サーバー、クラウド・コンピューティング、ストレージ
- テレコムおよびネットワークング、ポイント・オブ・ロード (POL)
- IPC、ファクトリ・オートメーション、PLC、テスト測定
- ハイエンド DTV

## 3 概要

TPS56C215 は、適応型オン時間 D-CAP3 制御モードを備えた小型でモノリシックな 12A 同期整流降圧コンバータです。このデバイスは、低  $R_{DS(on)}$  のパワー MOSFET を内蔵して高効率を実現し、外付け部品数が最小になるため、スペースの制約が厳しい電力システムでも使いやすくなっています。競争力の高い機能として、非常に正確な基準電圧、高速な負荷過渡応答、自動スキップ モードの動作による軽負荷時の高効率、可変の電流制限、外部補償が不要なことが挙げられます。強制連続導通モードにより、高性能 DSP や FPGA に求められる厳しい電圧レギュレーション精度要件を満たすことができます。TPS56C215 は放熱特性の優れた 18 ピン HotRod QFN パッケージで供給され、-40°C ~ 150°C の接合部温度で動作するよう設計されています。

### パッケージ情報

部品番号	パッケージ <sup>(1)</sup>	パッケージ サイズ <sup>(2)</sup>
TPS56C215	RNN (VQFN-HR, 18)	3.5mm × 3.5 mm

- (1) 詳細については、[セクション 10](#) を参照してください。
- (2) パッケージ サイズ (長さ × 幅) は公称値であり、該当する場合はピンも含まれます。

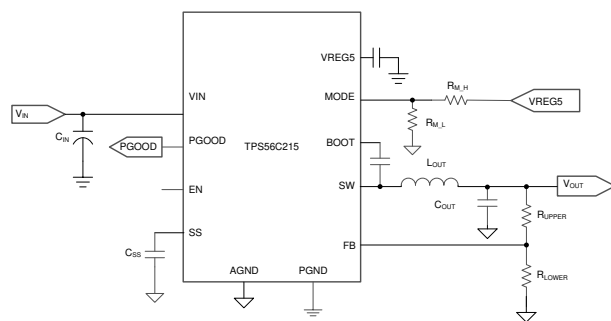

代表的なアプリケーション

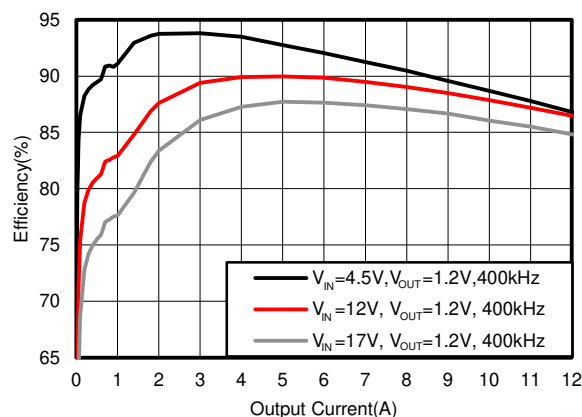

効率と出力電流との関係



## Table of Contents

<b>1 特長</b> .....	<b>1</b>	<b>7 Application and Implementation</b> .....	<b>20</b>
<b>2 アプリケーション</b> .....	<b>1</b>	7.1 Application Information.....	20
<b>3 概要</b> .....	<b>1</b>	7.2 Typical Application.....	20
<b>4 Pin Configuration and Functions</b> .....	<b>3</b>	7.3 Power Supply Recommendations.....	25
<b>5 Specifications</b> .....	<b>4</b>	7.4 Layout.....	26
5.1 Absolute Maximum Ratings.....	4	<b>8 Device and Documentation Support</b> .....	<b>29</b>
5.2 ESD Ratings.....	4	8.1 Device Support.....	29
5.3 Recommended Operating Conditions.....	4	8.2 ドキュメントの更新通知を受け取る方法.....	30
5.4 Thermal Information.....	5	8.3 サポート・リソース.....	30
5.5 Electrical Characteristics.....	5	8.4 Trademarks.....	30
5.6 Timing Requirements.....	6	8.5 静電気放電に関する注意事項.....	30
5.7 Typical Characteristics.....	7	8.6 用語集.....	30
<b>6 Detailed Description</b> .....	<b>12</b>	<b>9 Revision History</b> .....	<b>30</b>
6.1 Overview.....	12	<b>10 Mechanical, Packaging, and Orderable Information</b> .....	<b>31</b>
6.2 Functional Block Diagram.....	13	10.1 Package Marking.....	31
6.3 Feature Description.....	13		
6.4 Device Functional Modes.....	19		

## 4 Pin Configuration and Functions



図 4-1. RNN Package, 18-Pin VQFN

表 4-1. Pin Functions

PIN		TYPE <sup>(1)</sup>	DESCRIPTION
NAME	NO.		
BOOT	1	I	Supply input for the gate drive voltage of the high-side MOSFET. Connect the bootstrap capacitor between BOOT and SW.
VIN	2,11	P	Input voltage supply pin for the control circuitry. Connect the input decoupling capacitors between VIN and PGND.
PGND	3, 4, 5, 8, 9, 10	G	Power GND terminal for the controller circuit and the internal circuitry. Connect to AGND with a short trace.
SW	6, 7	O	Switch node terminal. Connect the output inductor to this pin.
AGND	12	G	Ground of internal analog circuitry. Connect AGND to PGND plane with a short trace.
FB	13	I	Converter feedback input. Connect to the center tap of the resistor divider between output voltage and AGND.
SS	14	O	Soft-Start time selection pin. Connecting an external capacitor sets the soft-start time and if no external capacitor is connected, the converter starts up in 1 ms.
EN	15	I	Enable input control, leaving this pin floating enables the converter. It can also be used to adjust the input UVLO by connecting to the center tap of the resistor divider between VIN and EN.
PGOOD	16	O	Open-drain power good indicator, it is asserted low if output voltage is out of PGOOD threshold, overvoltage, or if the device is under thermal shutdown, EN shutdown or during soft start.
VREG5	17	I/O	4.7-V internal LDO output which can also be driven externally with a 5-V input. This pin supplies voltage to the internal circuitry and gate driver. Bypass this pin with a 4.7- $\mu$ F capacitor.
MODE	18	I	Switching frequency, current limit selection and light load operation mode selection pin. Connect this pin to a resistor divider from VREG5 and AGND for different MODE options shown in 表 6-3.

(1) I = input, P = power, G = ground, O = output

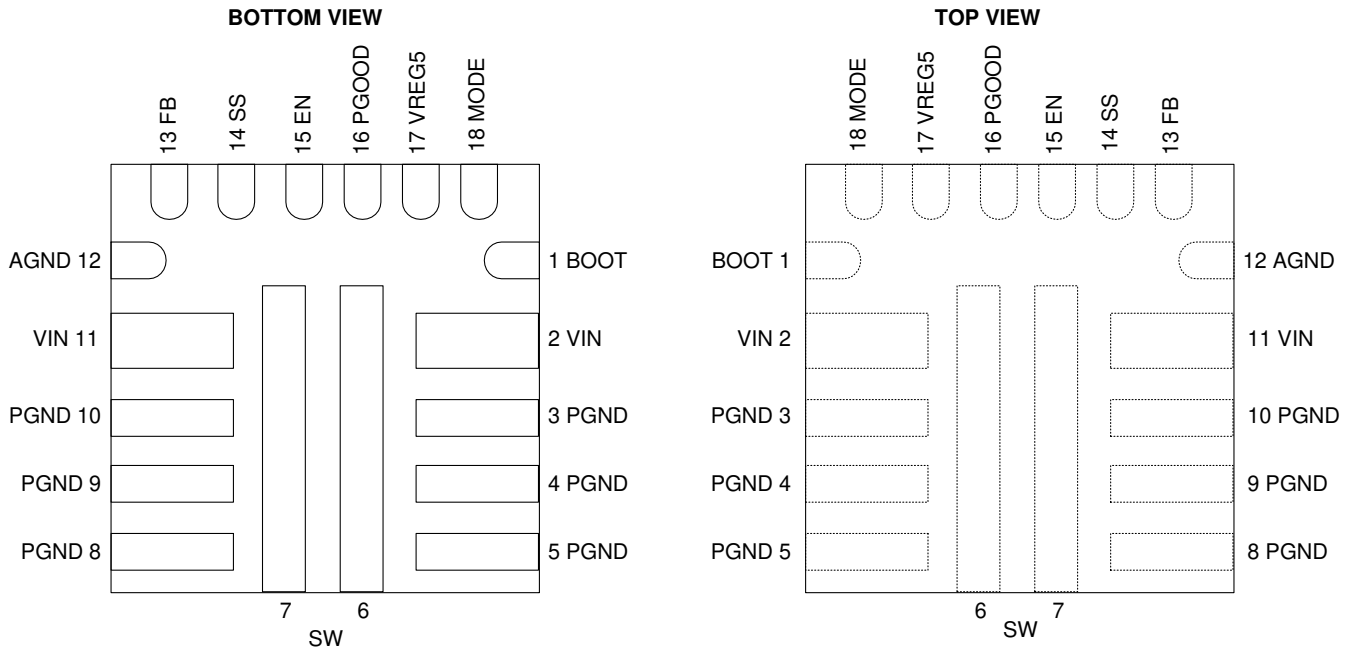
## 5 Specifications

### 5.1 Absolute Maximum Ratings

over operating free-air temperature range (unless otherwise noted) <sup>(1)</sup>

		MIN	MAX	UNIT
Input Voltage	V <sub>IN</sub>	-0.3	20	V
	SW	-2	19	
	SW (10-ns transient)	-5	25	
	V <sub>IN-SW</sub>		22	
	V <sub>IN-SW</sub> (10-ns transient)		25	
	EN	-0.3	6.5	
	BOOT –SW	-0.3	6.5	
	BOOT –SW (10 ns transient)	-0.3	7.5	
	BOOT	-0.3	25.5	
	SS, MODE, FB	-0.3	6.5	
	VREG5	-0.3	6	
Output Voltage	PGOOD	-0.3	6.5	V
Output Current <sup>(2)</sup>	I <sub>OUT</sub>		14	A
T <sub>J</sub>	Operating junction temperature	-40	150	°C
T <sub>stg</sub>	Storage temperature	-55	150	°C

- (1) Stresses beyond those listed under *Absolute Maximum Ratings* may cause permanent damage to the device. These are stress ratings only, which do not imply functional operation of the device at these or any other conditions beyond those indicated under *Recommended Operating Conditions*. Exposure to absolute-maximum-rated conditions for extended periods may affect device reliability.
- (2) to be consistent with the TI reliability requirement of 100k Power-On-Hours at 105°C junction temperature, the output current must not exceed 14A continuously under 100% duty operation as to prevent electromigration failure in the solder. Higher junction temperature or longer power-on hours are achievable at lower than 14A continuous output current.

### 5.2 ESD Ratings

		VALUE	UNIT
V <sub>(ESD)</sub> Electrostatic discharge	Human-body model (HBM), per ANSI/ESDA/JEDEC JS-001 <sup>(1)</sup>	±2000	V
	Charged-device model (CDM), per JEDEC specification JESD22-C101 <sup>(2)</sup>	±500	

- (1) JEDEC document JEP155 states that 500-V HBM allows safe manufacturing with a standard ESD control process.
- (2) JEDEC document JEP157 states that 250-V CDM allows safe manufacturing with a standard ESD control process.

### 5.3 Recommended Operating Conditions

over operating free-air temperature range (unless otherwise noted)

		MIN	NOM	MAX	UNIT
Input Voltage	V <sub>IN</sub>	3.8		17	V
	SW	-1.8		17	V
	BOOT	-0.1		23.5	V
	VREG5	-0.1		5.2	V
Output Current	I <sub>LOAD</sub>	0		12	A
Operating junction temperature	T <sub>J</sub>	-40		150	°C

## 5.4 Thermal Information

THERMAL METRIC <sup>(1)</sup>		RNN (VQFN-HR)	UNIT
		18 PINS	
R <sub>θJA</sub>	Junction-to-ambient thermal resistance	29.5	°C/W
R <sub>θJC(top)</sub>	Junction-to-case (top) thermal resistance	17.0	°C/W
R <sub>θJB</sub>	Junction-to-board thermal resistance	8.6	°C/W
Ψ <sub>JT</sub>	Junction-to-top characterization parameter	0.4	°C/W
Ψ <sub>JB</sub>	Junction-to-board characterization parameter	8.6	°C/W
R <sub>θJC(bot)</sub>	Junction-to-case (bottom) thermal resistance	0.5	°C/W

(1) For more information about traditional and new thermal metrics, see the [Semiconductor and IC Package Thermal Metrics](#) application note.

## 5.5 Electrical Characteristics

T<sub>J</sub> = -40°C to 150°C, V<sub>IN</sub> = 12V (unless otherwise noted)

PARAMETER		CONDITIONS	MIN	TYP	MAX	UNIT
<b>SUPPLY CURRENT</b>						
I <sub>IN</sub>	VIN supply current	T <sub>J</sub> = 25°C, V <sub>EN</sub> = 5 V, non switching		600	700	μA
I <sub>VINSDN</sub>	VIN shutdown current	T <sub>J</sub> = 25°C, V <sub>EN</sub> = 0 V		7		μA
<b>LOGIC THRESHOLD</b>						
V <sub>ENH</sub>	EN H-level threshold voltage		1.175	1.225	1.3	V
V <sub>ENL</sub>	EN L-level threshold voltage		1.025	1.104	1.15	V
V <sub>ENHYS</sub>				0.121		V
I <sub>ENp1</sub>	EN pullup current	V <sub>EN</sub> = 1.0 V	0.35	1.91	2.95	μA
I <sub>ENp2</sub>		V <sub>EN</sub> = 1.3 V	3	4.197	5.5	μA
<b>FEEDBACK VOLTAGE</b>						
V <sub>FB</sub>	FB voltage	T <sub>J</sub> = 25°C	598	600	602	mV
		T <sub>J</sub> = 0°C to 85°C	597.5	600	602.5	mV
		T <sub>J</sub> = -40°C to 85°C	594	600	602.5	mV
		T <sub>J</sub> = -40°C to 150°C	594	600	606	mV
<b>LDO VOLTAGE</b>						
V <sub>REG5</sub>	LDO output voltage	T <sub>J</sub> = -40°C to 150°C	4.58	4.7	4.83	V
ILIM5	LDO output current limit	T <sub>J</sub> = -40°C to 150°C	100	150	200	mA
<b>MOSFET</b>						
R <sub>DS(on)H</sub>	High side switch resistance	T <sub>J</sub> = 25°C, V <sub>VREG5</sub> = 4.7 V		13.5		mΩ
R <sub>DS(on)L</sub>	Low side switch resistance	T <sub>J</sub> = 25°C, V <sub>VREG5</sub> = 4.7 V		4.5		mΩ
<b>SOFT START</b>						
I <sub>ss</sub>	Soft start charge current	T <sub>J</sub> = -40°C to 150°C	4.9	6	7.1	μA
<b>CURRENT LIMIT</b>						
I <sub>OCL</sub>	Current Limit (Low side sourcing)	ILIM-1 option, Valley Current	9.775	11.5	13.225	A
		ILIM option, Valley Current	11.73	13.8	15.87	A
	Current limit (low side negative)	Valley Current		4		A
<b>POWER GOOD</b>						
V <sub>PGOODTH</sub>	PGOOD threshold	V <sub>FB</sub> falling (fault)		84%		
		V <sub>FB</sub> rising (good)		93%		
		V <sub>FB</sub> rising (fault)		116%		
		V <sub>FB</sub> falling (good)		107%		

## 5.5 Electrical Characteristics (続き)

$T_J = -40^{\circ}\text{C}$  to  $150^{\circ}\text{C}$ ,  $V_{IN} = 12\text{V}$  (unless otherwise noted)

PARAMETER		CONDITIONS	MIN	TYP	MAX	UNIT
<b>OUTPUT UNDERVOLTAGE AND OVERVOLTAGE PROTECTION</b>						
$V_{OVP}$	Output OVP threshold	OVP detect		$121\% \times V_{FB}$		
$V_{UVP}$	Output UVP threshold	Hiccup detect		$68\% \times V_{FB}$		
<b>THERMAL SHUTDOWN</b>						
$T_{SDN}$	Thermal shutdown threshold	Shutdown temperature		160		$^{\circ}\text{C}$
		Hysteresis		15		$^{\circ}\text{C}$
<b>UVLO</b>						
UVLO	UVLO threshold	VREG5 rising voltage		4.3		V
		VREG5 falling voltage		3.57		V
		VREG5 hysteresis		730		mV
UVLO, VREG5 = 4.7V	UVLO threshold, VREG5 = 4.7V	VIN rising voltage, VREG5 = 4.7V		3.32		V
		VIN falling voltage, VREG5 = 4.7V		3.26		V
		VIN hysteresis, VREG5 = 4.7V		60		mV

## 5.6 Timing Requirements

PARAMETER		CONDITIONS	MIN	TYP	MAX	UNIT
<b>ON-TIME TIMER CONTROL</b>						
$t_{ON}$	SW On Time <sup>(1)</sup>	$V_{IN} = 12\text{V}$ , $V_{OUT} = 3.3\text{V}$ , $F_{SW} = 800\text{kHz}$	310	340	380	ns
$t_{ON\ min}$	SW Minimum on time	$V_{IN} = 17\text{V}$ , $V_{OUT} = 0.6\text{V}$ , $F_{SW} = 1200\text{kHz}$		54		ns
$t_{OFF}$	SW Minimum off time	$25^{\circ}\text{C}$ , $V_{FB} = 0.5\text{V}$			310	ns
<b>SOFT START</b>						
$t_{SS}$	Soft-start time	Internal soft-start time		1.045		ms
<b>OUTPUT UNDERVOLTAGE AND OVERVOLTAGE PROTECTION</b>						
$t_{UVPDEL}$	Output hiccup delay relative to SS time	UVP detect		1		cycle
$t_{UVPEN}$	Output hiccup enable delay relative to SS time	UVP detect		7		cycle

(1) Specified by design

## 5.7 Typical Characteristics

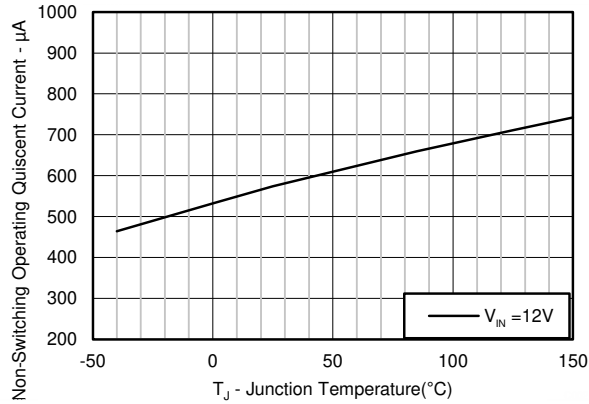

5-1. Quiescent Current vs Temperature

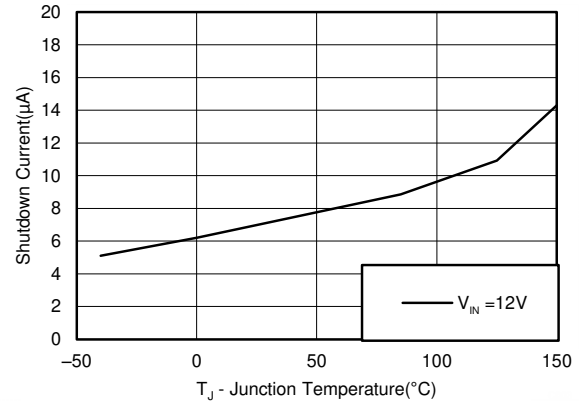

5-2. Shutdown Current vs Temperature

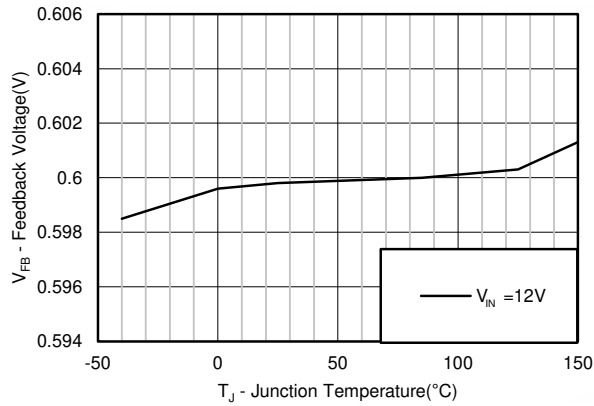

5-3. Feedback Voltage vs Temperature

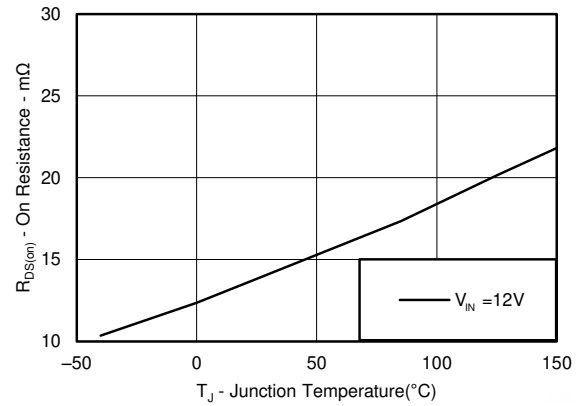

5-4. High-side R<sub>DS(on)</sub> vs Temperature

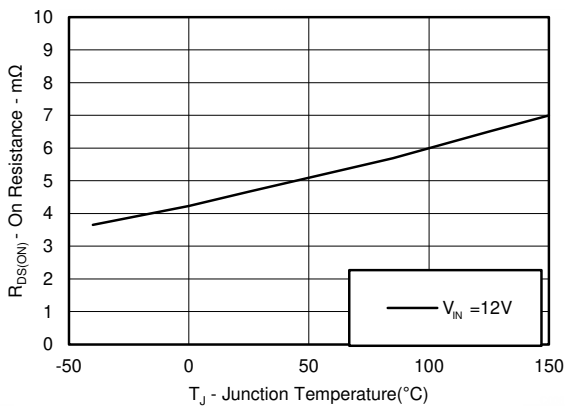

5-5. Low-side R<sub>DS(on)</sub> vs Temperature

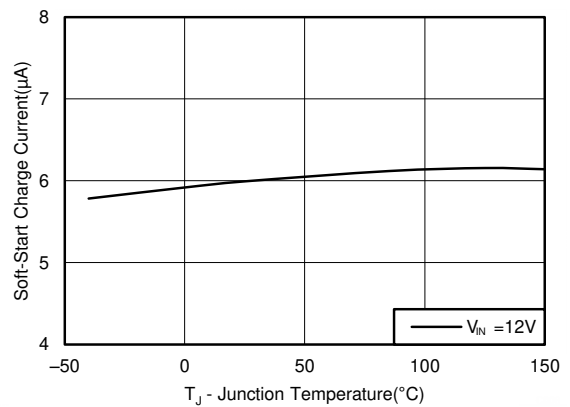

5-6. Soft-Start Charge Current vs Temperature

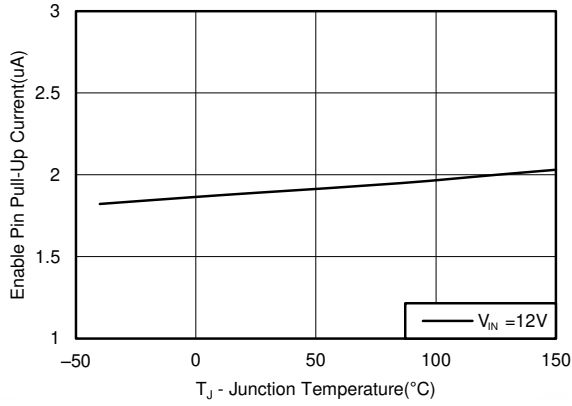

5-7. Enable Pullup Current,  $V_{EN} = 1.0\text{ V}$

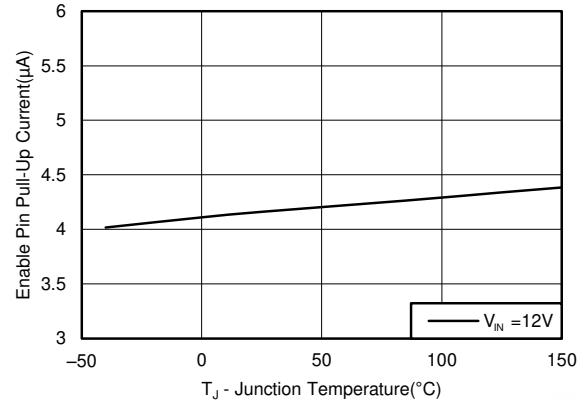

5-8. Enable Pullup Current,  $V_{EN} = 1.3\text{ V}$

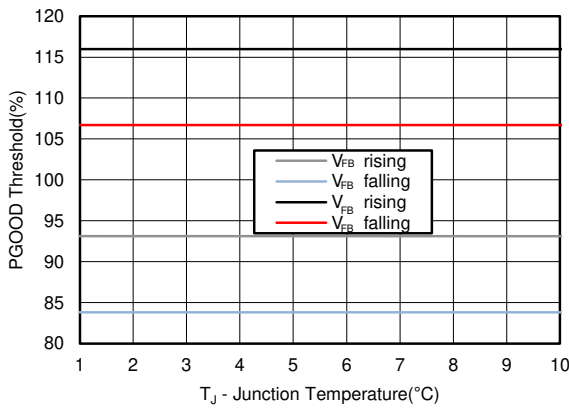

5-9. PGOOD Threshold vs Temperature

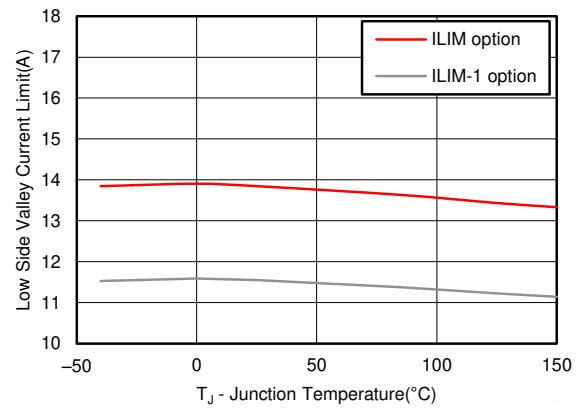

5-10. Current Limit vs Temperature

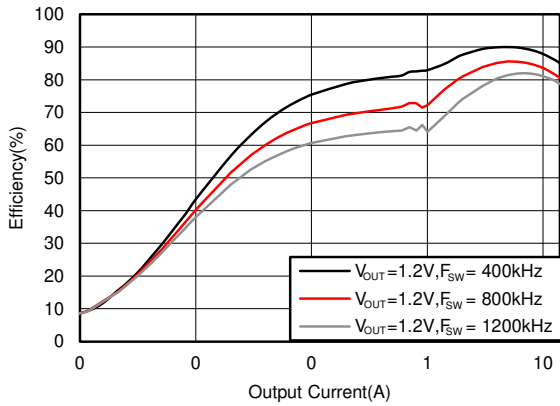

5-11. Efficiency with Internal VREG5 = 4.7 V,  $V_{IN} = 12\text{ V}$

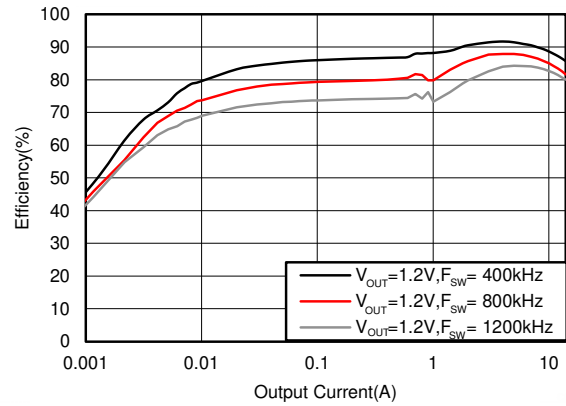

5-12. Efficiency with External VREG5 = 5 V,  $V_{IN} = 12\text{ V}$



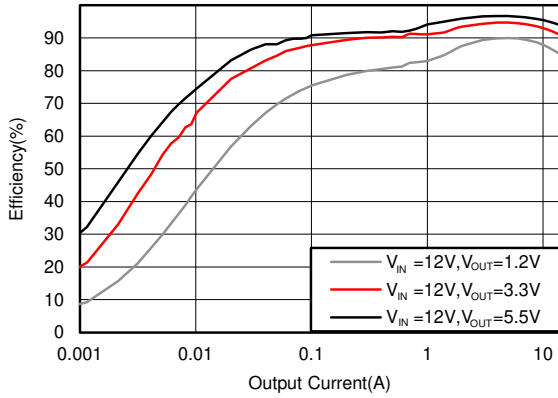

5-13. Efficiency, Mode = DCM,  $F_{SW} = 400$  kHz

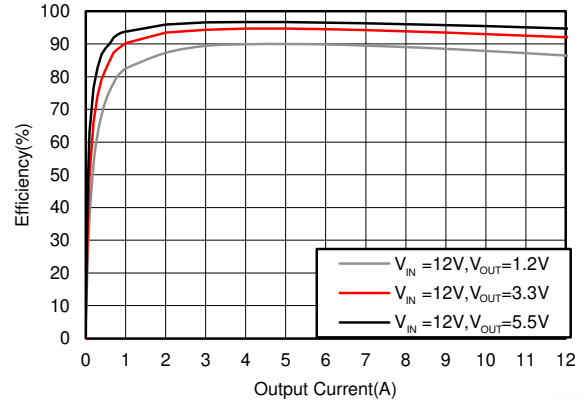

5-14. Efficiency, Mode = FCCM,  $F_{SW} = 400$  kHz

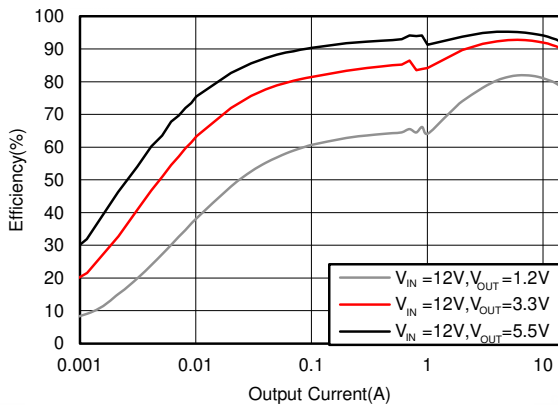

5-15. Efficiency, Mode = DCM,  $F_{SW} = 1200$  kHz

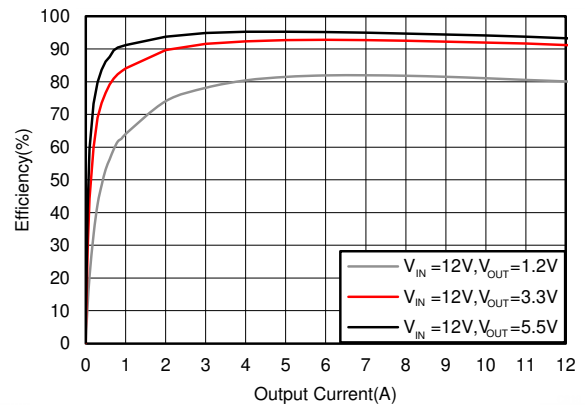

5-16. Efficiency, Mode = FCCM,  $F_{SW} = 1200$  kHz

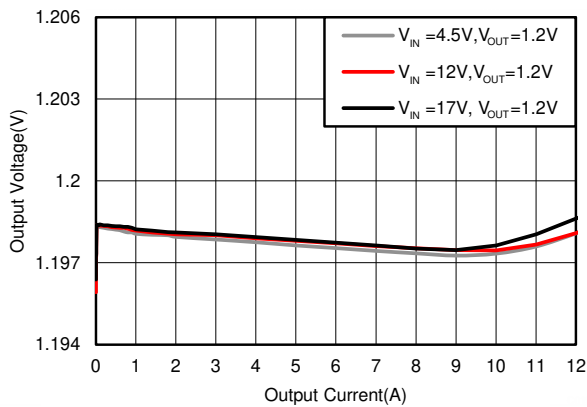

5-17. Load Regulation,  $F_{SW} = 800$  kHz

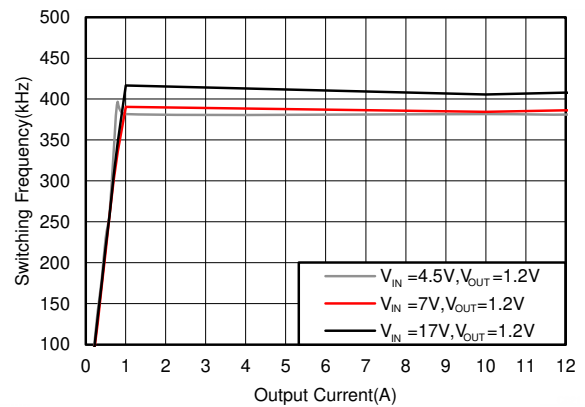

5-18.  $F_{SW}$  Load Regulation, Mode = DCM,  $F_{SW} = 400$  kHz

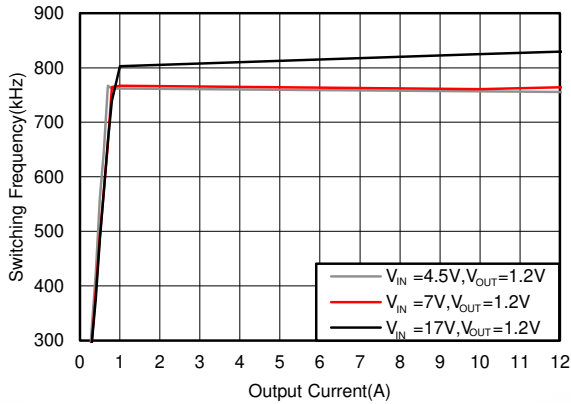

**5-19.  $F_{SW}$  Load Regulation, Mode = DCM,  $F_{SW}$  = 800 kHz**

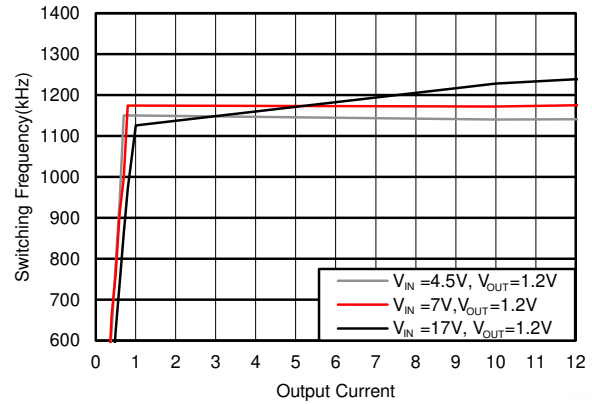

**5-20.  $F_{SW}$  Load Regulation, Mode = DCM,  $F_{SW}$  = 1200 kHz**

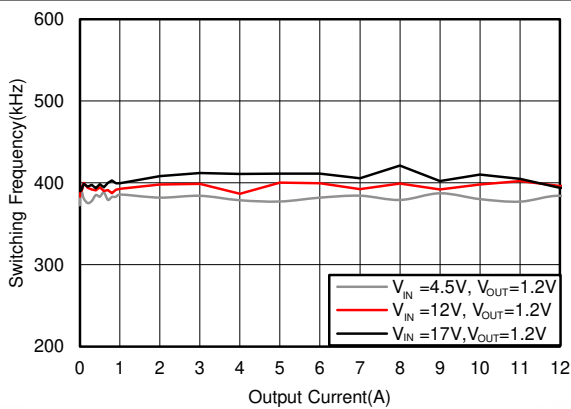

**5-21.  $F_{SW}$  Load Regulation, Mode = FCCM,  $F_{SW}$  = 400 kHz**

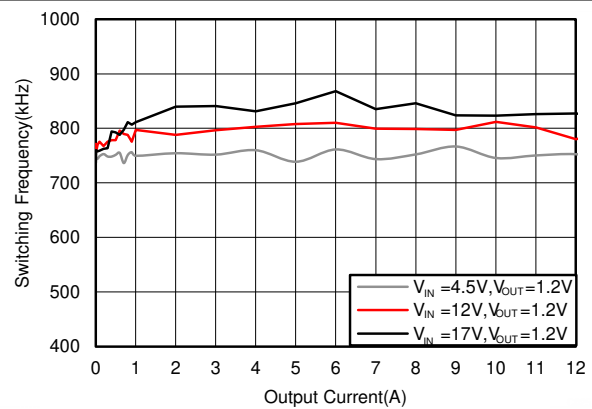

**5-22.  $F_{SW}$  Load Regulation, Mode = FCCM,  $F_{SW}$  = 800 kHz**

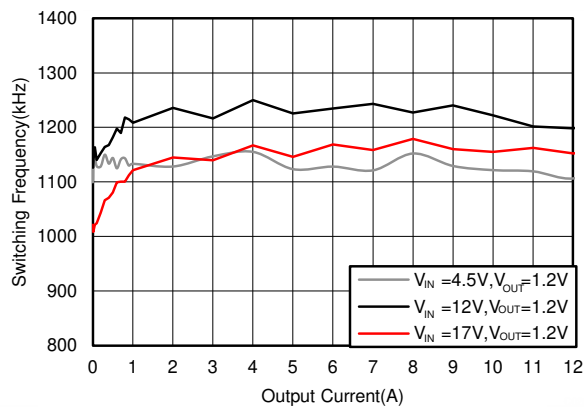

**5-23.  $F_{SW}$  Load Regulation, Mode = FCCM,  $F_{SW}$  = 1200 kHz**

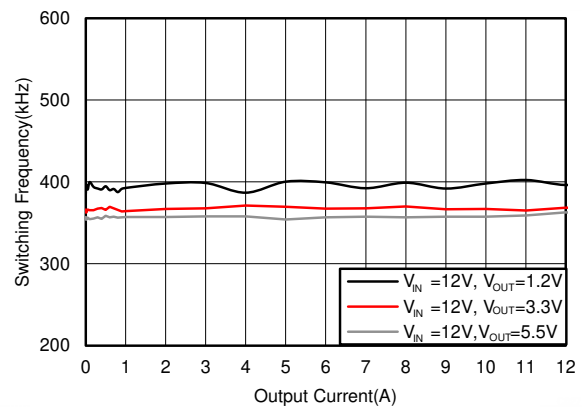

**5-24.  $F_{SW}$  Load Regulation, Mode = FCCM,  $F_{SW}$  = 400 kHz**

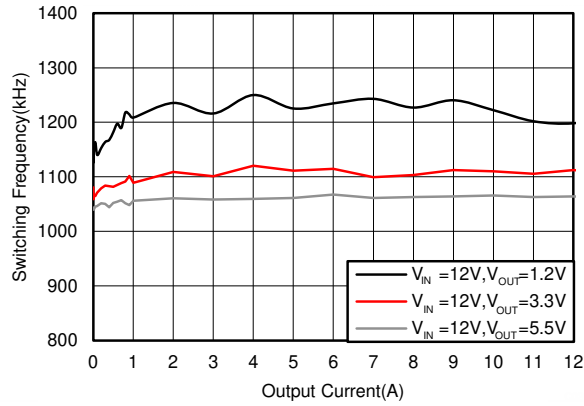

5-25.  $F_{SW}$  Load Regulation, Mode = FCCM,  $F_{SW} = 1200$  kHz

## 6 Detailed Description

### 6.1 Overview

The TPS56C215 is a high-density, synchronous, step-down buck converter which can operate from 3.8-V to 17-V input voltage ( $V_{IN}$ ). The device has 13.5-m $\Omega$  and 4.5-m $\Omega$  integrated MOSFETs that enable high efficiency up to 12 A. The device employs D-CAP3 control mode that provides fast transient response with no external compensation components and an accurate feedback voltage. The control topology provides seamless transition between FCCM operating mode at higher load condition and DCM/Eco-mode operation at lighter load condition. DCM/Eco-mode allows the TPS56C215 to maintain high efficiency at light load. The TPS56C215 is able to adapt to both low equivalent series resistance (ESR) output capacitors such as POSCAP or SP-CAP, and ultra-low ESR ceramic capacitors.

The TPS56C215 has three selectable switching frequencies ( $F_{SW}$ ) (400 kHz, 800 kHz, and 1200 kHz), which gives the flexibility to optimize the design for higher efficiency or smaller size. There are two selectable current limits. All these options are configured by choosing the right voltage on the MODE pin.

The TPS56C215 has a 4.7-V internal LDO that creates bias for all internal circuitry. There is a feature to overdrive this internal LDO with an external voltage on the VREG5 pin which improves the efficiency of the converter. The undervoltage lockout (UVLO) circuit monitors the VREG5 pin voltage to protect the internal circuitry from low input voltages. The device has an internal pullup current source on the EN pin which can enable the device even with the pin floating.

Soft-start time can be selected by connecting a capacitor to the SS pin. The device is protected from output short, undervoltage, and overtemperature conditions.

## 6.2 Functional Block Diagram

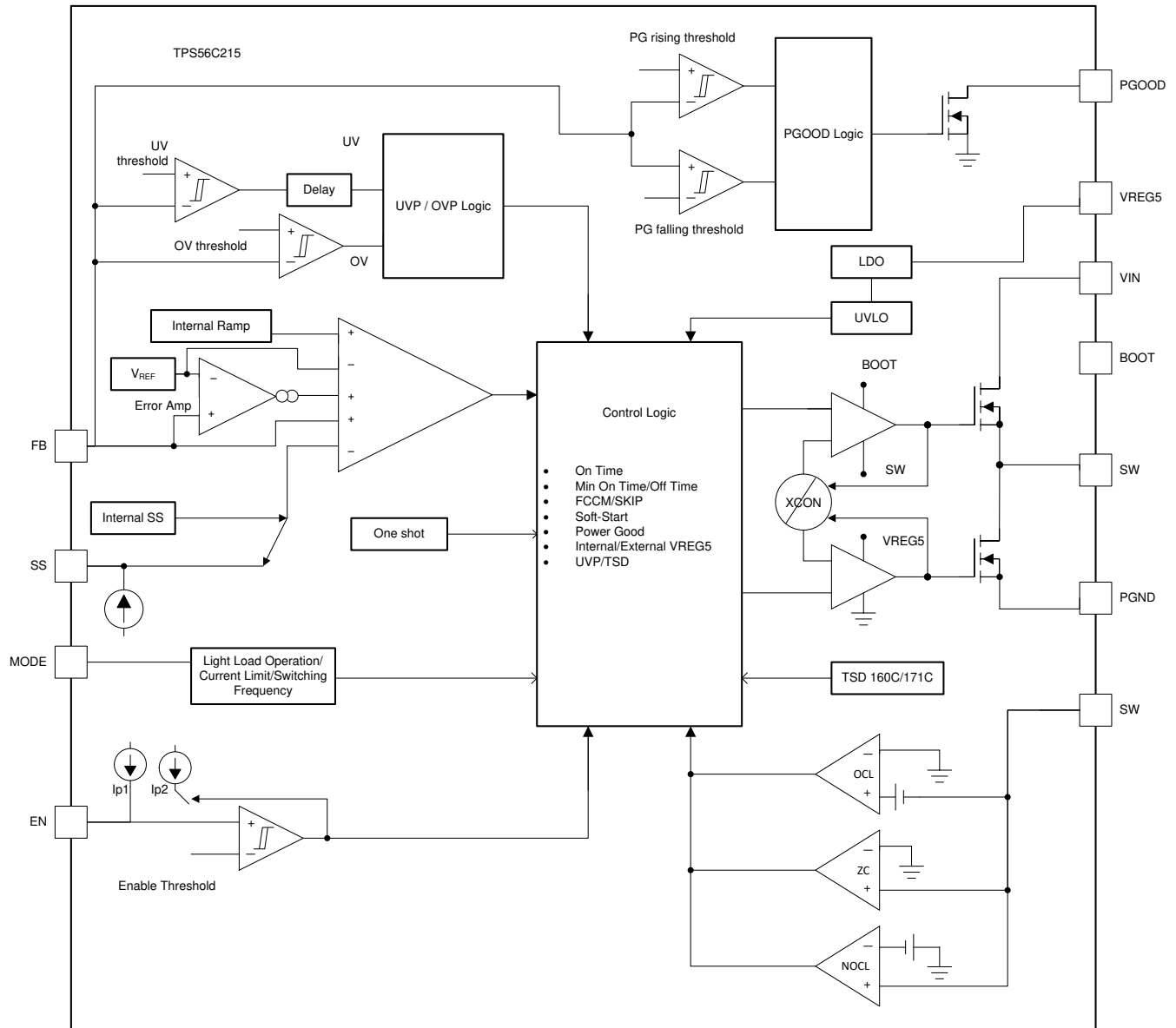

## 6.3 Feature Description

### 6.3.1 PWM Operation and D-CAP3™ Control Mode

The TPS56C215 operates using the adaptive on-time PWM control with a proprietary D-CAP3 control mode which enables low external component count with a fast load transient response while maintaining a good output voltage accuracy. At the beginning of each switching cycle, the high-side MOSFET is turned on for an on-time set by an internal one shot timer. This on-time is set based on the input voltage of the converter, output voltage of the converter, and the pseudo-fixed frequency, hence this type of control topology is called an adaptive on-time control. The one-shot timer resets and turns on again after the feedback voltage ( $V_{FB}$ ) falls below the internal reference voltage ( $V_{REF}$ ). An internal ramp is generated which is fed to the FB pin to simulate the output voltage ripple. This enables the use of very low-ESR output capacitors such as multi-layered ceramic caps (MLCC). No external current sense network or loop compensation is required for DCAP3 control topology.

The TPS56C215 includes an error amplifier that makes the output voltage very accurate. This error amplifier is absent in other flavors of DCAP3. For any control topology that is compensated internally, there is a range of the output filter it can support. The output filter used with the TPS56C215 is a low-pass L-C circuit. This L-C filter has double pole that is described in 式 1.

$$f_P = \frac{1}{2 \times \pi \times \sqrt{L_{OUT} \times C_{OUT}}} \quad (1)$$

At low frequencies, the overall loop gain is set by the output set-point resistor divider network and the internal gain of the TPS56C215. The low frequency L-C double pole has a 180 degree in-phase. At the output filter frequency, the gain rolls off at a –40-dB per decade rate and the phase drops rapidly. The internal ripple generation network introduces a high-frequency zero that reduces the gain roll off from –40-dB to –20-dB per decade and increases the phase to 90 degree one decade above the zero frequency. The internal ripple injection high frequency zero is changed according to the switching frequency selected as shown in 表 6-1. The inductor and capacitor selected for the output filter must be such that the double pole is located close enough to the high-frequency zero so that the phase boost provided by this high-frequency zero provides adequate phase margin for the stability requirement. The crossover frequency of the overall system must usually be targeted to be less than one-fifth of the switching frequency ( $F_{SW}$ ).

**表 6-1. Ripple Injection Zero**

SWITCHING FREQUENCY (kHz)	ZERO LOCATION (kHz)
400	7.1
800	14.3
1200	21.4

表 6-2 lists the inductor values and part numbers that are used to plot the efficiency curves in セクション 5.7.

**表 6-2. Inductor Values**

$V_{OUT}(V)$	$F_{SW}(kHz)$	$L_{OUT}(\mu H)$	WÜRTH PART NUMBER <sup>(1)</sup>
1.2	400	1.2	744325120
	800	0.68	744311068
	1200	0.47	744314047
3.3	400	2.4	744325240
	800	1.5	7443552150
	1200	1.2	744325120
5.5	400	3.3	744325330
	800	2.4	744325240
	1200	1.5	7443552150

(1) See [Third-Party Products](#) disclaimer.

### 6.3.2 Eco-mode Control

The TPS56C215 is designed with Eco-mode control to increase efficiency at light loads. This option can be chosen using the MODE pin as shown in 表 6-3. As the output current decreases from heavy load condition, the inductor current is also reduced. If the output current is reduced enough, the valley of the inductor current reaches the zero level, which is the boundary between continuous conduction and discontinuous conduction modes. The low-side MOSFET is turned off when a zero inductor current is detected. As the load current further decreases the converter runs into discontinuous conduction mode. The on-time is kept approximately the same as it is in continuous conduction mode. The off-time increases as it takes more time to discharge the output with a smaller load current. The light load current where the transition to Eco-mode operation happens ( $I_{OUT(LL)}$ ) can be calculated from 式 2.

$$I_{OUT(LL)} = \frac{1}{2 \times L_{OUT} \times F_{SW}} \times \frac{(V_{IN} - V_{OUT}) \times V_{OUT}}{V_{IN}} \quad (2)$$

After identifying the application requirements, design the output inductance ( $L_{OUT}$ ) so that the inductor peak-to-peak ripple current is approximately between 20% and 30% of the  $I_{OUT(max)}$  (peak current in the application). It is also important to size the inductor properly so that the valley current does not hit the negative low-side current limit.

### 6.3.3 4.7-V LDO

The VREG5 pin is the output of the internal 4.7-V linear regulator that creates the bias for all the internal circuitry and MOSFET gate drivers. The VREG5 pin needs to be bypassed with a 4.7- $\mu$ F capacitor. An external voltage that is above the internal output voltage of the LDO can override the internal LDO, switching it to the external rail after a higher voltage is detected. This enhances the efficiency of the converter because the quiescent current now runs off this external rail instead of the input power supply. The UVLO circuit monitors the VREG5 pin voltage and disables the output when VREG5 falls below the UVLO threshold. When using an external bias on the VREG5 rail, any power-up and power-down sequencing can be applied but it is important to understand that if there is a discharge path on the VREG5 rail that can pull a current higher than the internal current limit of the LDO (ILIM5) from the VREG5, then the VREG5 LDO turns off thereby shutting down the output of TPS56C215. If such condition does not exist and if the external VREG5 rail is turned off, the VREG5 voltage switches over to the internal LDO voltage which is 4.7 V typically in a few nanoseconds. [Figure 6-1](#) shows this transition of the VREG5 voltage from an external bias of 5.5 V to the internal LDO output of 4.7 V when the external bias to VREG5 is disabled while the output of TPS56C215 remains unchanged.



図 6-1. VREG5 Transition

### 6.3.4 MODE Selection

The TPS56C215 has a MODE pin that can offer 12 different states of operation as a combination of current limit, switching frequency, and light load operation. The device can operate at two different current limits ILIM-1 and ILIM to support an output continuous current of 10 A and 12 A, respectively. The TPS56C215 is designed to compare the valley current of the inductor against the current limit thresholds so understand that the output

current is half the ripple current higher than the valley current. For example, with the ILIM current limit selection, the OCL threshold is 11.73-A minimum, which means that a pk-pk inductor ripple current of 0.54-A minimum is needed to be able to draw 12 A out of the converter without entering an overcurrent condition. The TPS56C215 can operate at three different frequencies of 400 kHz, 800 kHz, and 1200 kHz and also can choose between Eco-mode and FCCM mode. The device reads the voltage on the MODE pin during start-up and latches onto one of the MODE options listed in 表 6-3. The voltage on the MODE pin can be set by connecting this pin to the center tap of a resistor divider connected between VREG5 and AGND. A guideline for the top resistor ( $R_{M\_H}$ ) and the bottom resistor ( $R_{M\_L}$ ) in 1% resistors is shown in 表 6-3. It is important that the voltage for the MODE pin is derived from the VREG5 rail only because internally this voltage is referenced to detect the MODE option. The MODE pin setting can be reset only by a VIN power cycling.

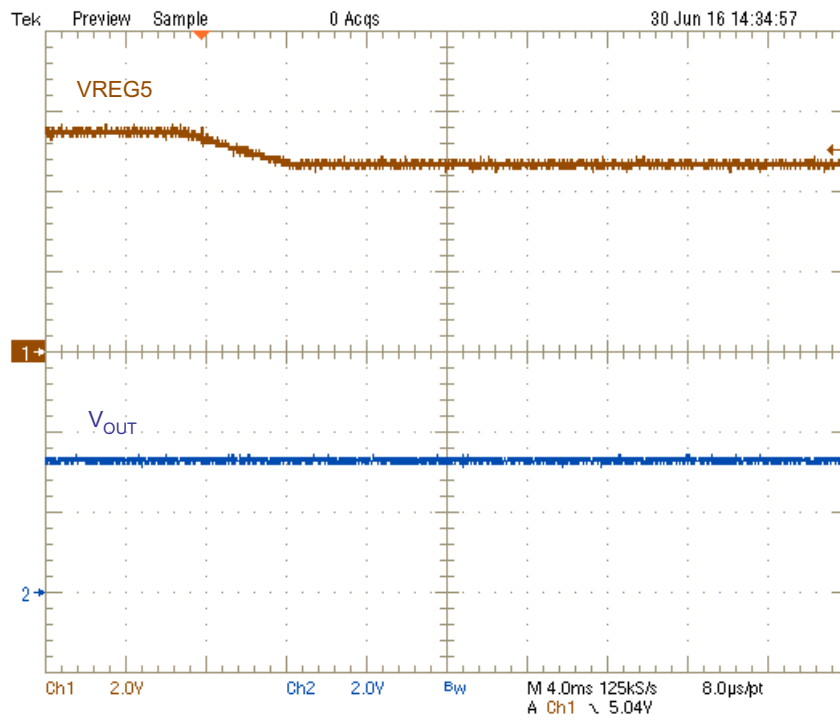
**表 6-3. MODE Pin Resistor Settings**

$R_{M\_L}$ (k $\Omega$ )	$R_{M\_H}$ (k $\Omega$ )	LIGHT LOAD OPERATION	CURRENT LIMIT	FREQUENCY (kHz)
5.1	300	FCCM	ILIM-1	400
10	200	FCCM	ILIM	400
20	160	FCCM	ILIM-1	800
20	120	FCCM	ILIM	800
51	200	FCCM	ILIM-1	1200
51	180	FCCM	ILIM	1200
51	150	DCM	ILIM-1	400
51	120	DCM	ILIM	400
51	91	DCM	ILIM-1	800
51	82	DCM	ILIM	800
51	62	DCM	ILIM-1	1200
51	51	DCM	ILIM	1200

図 6-2 shows the typical start-up sequence of the device after the EN pin voltage crosses the EN turn-on threshold. After the voltage on VREG5 pin crosses the rising UVLO threshold, it takes 100  $\mu$ s to read the first MODE setting and approximately 100  $\mu$ s from there to finish the last MODE setting. The output voltage starts ramping after the MODE setting reading is completed.





図 6-2. Power-Up Sequence

### 6.3.5 Soft Start and Prebiased Soft Start

The TPS56C215 has an adjustable soft start time that can be set by connecting a capacitor on SS pin. When the EN pin becomes high, the soft-start charge current ( $I_{SS}$ ) begins charging the external capacitor ( $C_{SS}$ ) connected between SS and AGND. The device tracks the lower of the internal soft-start voltage or the external soft-start voltage as the reference. The equation for the soft-start time ( $T_{SS}$ ) is shown in 式 3:

$$T_{SS(S)} = \frac{C_{SS} \times V_{REF}}{I_{SS}} \quad (3)$$

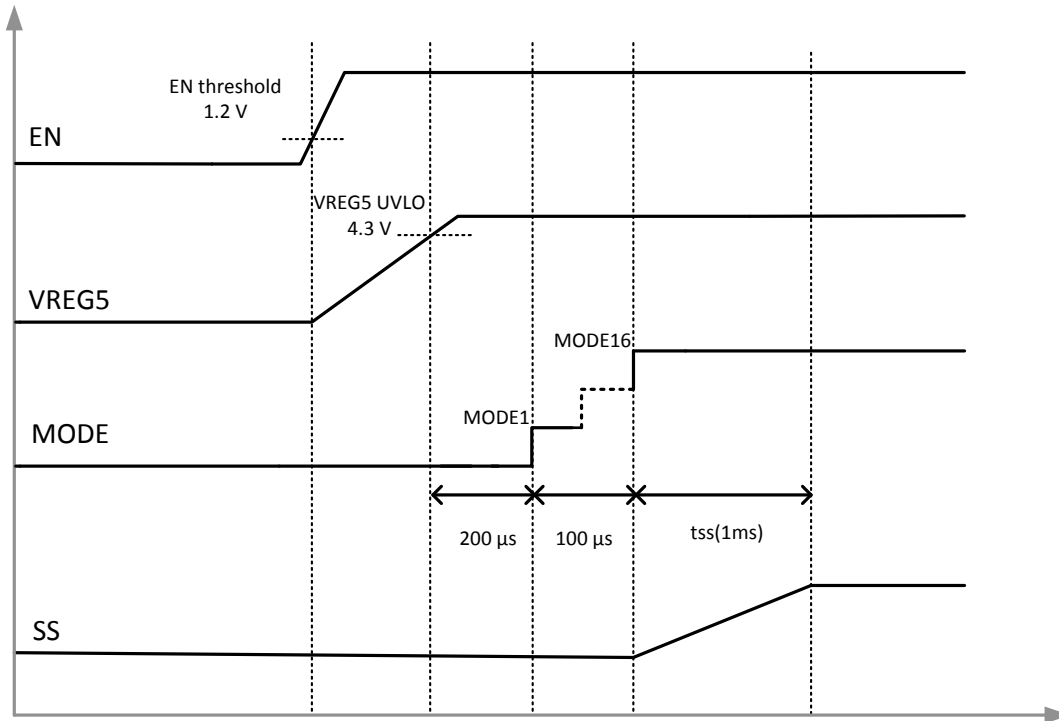
where

- $V_{REF}$  is 0.6 V and  $I_{SS}$  is 6  $\mu$ A

If the output capacitor is prebiased at start-up, the device initiates switching and starts ramping up only after the internal reference voltage becomes greater than the feedback voltage  $V_{FB}$ . This scheme makes sure that the converters ramp up smoothly into regulation point.

### 6.3.6 Enable and Adjustable UVLO

The EN pin controls the turn-on and turnoff of the device. When EN pin voltage is above the turn-on threshold which is around 1.2 V, the device starts switching and when the EN pin voltage falls below the turnoff threshold, which is around 1.1 V, it stops switching. If the user application requires a different turn-on ( $V_{START}$ ) and turnoff thresholds ( $V_{STOP}$ ) respectively, the EN pin can be configured as shown in 図 6-3 by connecting a resistor divider between VIN and EN. The EN pin has a pullup current  $I_{p1}$  that sets the default state of the pin when it is floating. This current increases to  $I_{p2}$  when the EN pin voltage crosses the turn-on threshold. The UVLO thresholds can be set by using 式 4 and 式 5.



図 6-3. Adjustable VIN Undervoltage Lockout

$$R1 = \frac{V_{\text{START}} \left( \frac{V_{\text{ENFALLING}}}{V_{\text{ENRISING}}} \right) - V_{\text{STOP}}}{I_{p1} \left( 1 - \frac{V_{\text{ENFALLING}}}{V_{\text{ENRISING}}} \right) + I_h} \quad (4)$$

$$R2 = \frac{R1 \times V_{\text{ENFALLING}}}{V_{\text{STOP}} - V_{\text{ENFALLING}} + R1 I_{p2}} \quad (5)$$

where

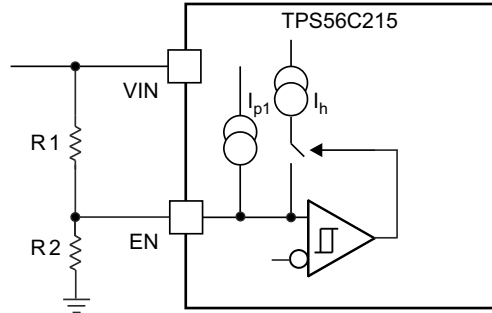
- $I_{p2} = 4.197 \mu\text{A}$
- $I_{p1} = 1.91 \mu\text{A}$
- $I_h = 2.287 \mu\text{A}$
- $V_{\text{ENRISING}} = 1.225 \text{ V}$
- $V_{\text{ENFALLING}} = 1.104 \text{ V}$

### 6.3.7 Power Good

The Power Good (PGOOD) pin is an open-drain output. After the FB pin voltage is between 93% and 107% of the internal reference voltage ( $V_{\text{REF}}$ ), the PGOOD is de-asserted and floats after a 200- $\mu\text{s}$  de-glitch time. A pullup resistor of 10 k $\Omega$  is recommended to pull it up to VREG5. The PGOOD pin is pulled low when the FB pin voltage is lower than  $V_{\text{OVP}}$  or greater than  $V_{\text{OVP}}$  threshold, in an event of thermal shutdown, or during the soft-start period.

### 6.3.8 Overcurrent Protection and Undervoltage Protection

The output overcurrent limit (OCL) is implemented using a cycle-by-cycle valley detect control circuit. The switch current is monitored during the OFF state by measuring the low-side FET drain to source voltage. This voltage is proportional to the switch current. During the on-time of the high-side FET switch, the switch current increases at a linear rate determined by input voltage, output voltage, the on-time, and the output inductor value. During the on-time of the low-side FET switch, this current decreases linearly. The average value of the switch current is the load current  $I_{\text{OUT}}$ . If the measured drain-to-source voltage of the low-side FET is above the voltage proportional to current limit, the low-side FET stays on until the current level becomes lower than the OCL level which reduces the output current available. When the current is limited the output voltage tends to drop because the load demand is higher than what the converter can support. When the output voltage falls below 68% of the target voltage, the UVP comparator detects it and shuts down the device after a wait time of 1 ms, the device restarts after a hiccup time of 7 ms. In this type of valley detect control, the load current is higher than the OCL threshold by one half of the peak-to-peak inductor ripple current. When the overcurrent condition is removed, the output voltage returns to the regulated value. If an OCL condition happens during start-up, then the device enters hiccup-mode immediately without a wait time of 1 ms.

### **6.3.9 UVLO Protection**

Undervoltage lockout protection (UVLO) monitors the internal VREG5 regulator voltage. When the VREG5 voltage is lower than UVLO threshold voltage, the device is shut off. This protection is non-latching.

### **6.3.10 Thermal Shutdown**

The device monitors the internal die temperature. If this temperature exceeds the thermal shutdown threshold value ( $T_{SDN}$  typically  $160^{\circ}\text{C}$ ), the device shuts off. This protection is a non-latch protection. During start-up, if the device temperature is higher than  $160^{\circ}\text{C}$ , the device does not start switching and does not load the MODE settings. If the device temp goes higher than  $T_{SDN}$  threshold after start-up, the device stops switching with SS reset to ground and an internal discharge switch turns on to quickly discharge the output voltage. The device re-starts switching when the temperature goes below the thermal shutdown threshold but the MODE settings are not re-loaded again.

### **6.3.11 Output Voltage Discharge**

The device has a  $500\text{-}\Omega$  discharge switch that discharges the output  $V_{OUT}$  through SW node during any event of fault like output overvoltage, output undervoltage, TSD, if VREG5 voltage below the UVLO and when the EN pin voltage ( $V_{EN}$ ) is below the turn-on threshold.

## **6.4 Device Functional Modes**

### **6.4.1 Light Load Operation**

When the MODE pin is selected to operate in FCCM mode, the converter operates in continuous conduction mode (FCCM) during light-load conditions. During FCCM, the switching frequency ( $F_{SW}$ ) is maintained at an almost constant level over the entire load range which is suitable for applications requiring tight control of the switching frequency and output voltage ripple at the cost of lower efficiency under light load. If the MODE pin is selected to operate in DCM/Eco-mode, the device enters pulse skip mode after the valley of the inductor ripple current crosses zero. The Eco-mode maintains higher efficiency at light load with a lower switching frequency.

### **6.4.2 Standby Operation**

The TPS56C215 can be placed in standby mode by pulling the EN pin low. The device operates with a shutdown current of  $7\text{ }\mu\text{A}$  when in standby condition.

## 7 Application and Implementation

### 注

以下のアプリケーション情報は、TI の製品仕様に含まれるものではなく、TI ではその正確性または完全性を保証いたしません。個々の目的に対する製品の適合性については、お客様の責任で判断していただくこととなります。お客様は自身の設計実装を検証しテストすることで、システムの機能を確認する必要があります。

### 7.1 Application Information

The schematic of [図 7-1](#) shows a typical application for TPS56C215. This design converts an input voltage range of 4.5 V to 17 V down to 1.2 V with a maximum output current of 12 A.

### 7.2 Typical Application



図 7-1. Application Schematic

#### 7.2.1 Design Requirements

表 7-1. Design Parameters

PARAMETER	CONDITIONS	MIN	TYP	MAX	UNIT
$V_{OUT}$	Output voltage		1.2		V
$I_{OUT}$	Output current		12		A
$\Delta V_{OUT}$	Transient response		40		mV
$V_{IN}$	Input voltage	4.5	12	17	V
$V_{OUT(ripple)}$	Output voltage ripple		20		mV <sub>(P-P)</sub>
	Start input voltage		Internal UVLO		V
	Stop input voltage		Internal UVLO		V
$F_{SW}$	Switching frequency		1.2		MHz
Operating Mode			DCM		
$T_A$	Ambient temperature		25		°C

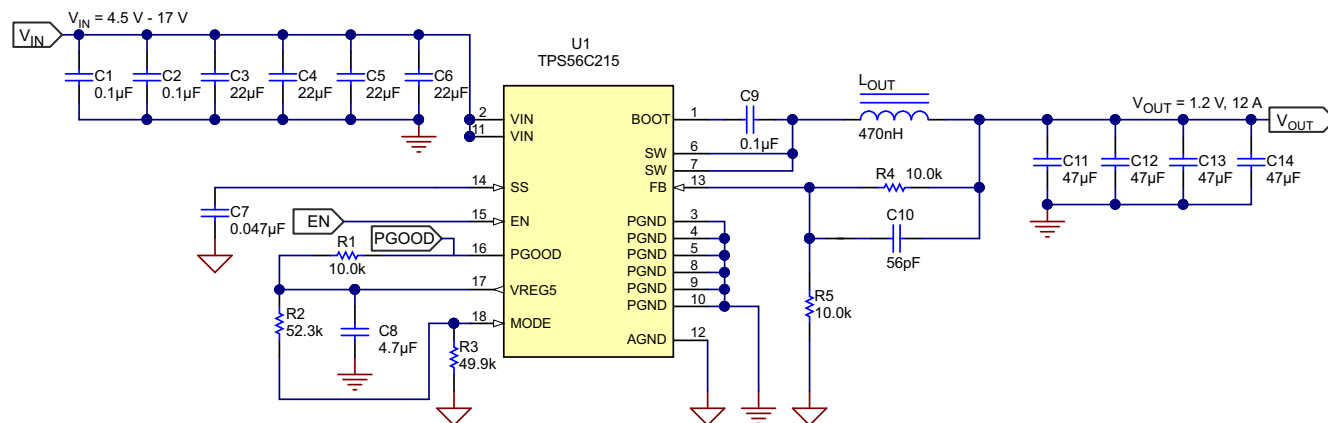
#### 7.2.2 Detailed Design Procedure

##### 7.2.2.1 External Component Selection

###### 7.2.2.1.1 Output Voltage Set Point

To change the output voltage of the application, it is necessary to change the value of the upper feedback resistor. By changing this resistor the user can change the output voltage above 0.6 V. See [式 6](#).

$$V_{OUT} = 0.6 \times \left( 1 + \frac{R_{UPPER}}{R_{LOWER}} \right) \quad (6)$$

### 7.2.2.1.2 Switching Frequency and MODE Selection

Switching Frequency, current limit, and switching mode (DCM or FCCM) are set by a voltage divider from VREG5 to GND connected to the MODE pin. See 表 6-3 for possible MODE pin configurations. Switching frequency selection is a tradeoff between higher efficiency and smaller system solution size. Lower switching frequency yields higher overall efficiency but relatively bigger external components. Higher switching frequencies cause additional switching losses which impact efficiency and thermal performance. For this design, 1.2 MHz is chosen as the switching frequency, the switching mode is DCM and the output current is 12 A.

### 7.2.2.1.3 Inductor Selection

The inductor ripple current is filtered by the output capacitor. A higher inductor ripple current means the output capacitor must have a ripple current rating higher than the inductor ripple current. See 表 7-2 for recommended inductor values.

The RMS and peak currents through the inductor can be calculated using 式 7 and 式 8. It is important that the inductor is rated to handle these currents.

$$I_{L(rms)} = \sqrt{\left( I_{OUT}^2 + \frac{1}{12} \times \left( \frac{V_{OUT} \times (V_{IN(max)} - V_{OUT})}{V_{IN(max)} \times L_{OUT} \times F_{SW}} \right)^2 \right)} \quad (7)$$

$$I_{L(peak)} = I_{OUT} + \frac{I_{OUT(ripple)}}{2} \quad (8)$$

During transient/short circuit conditions the inductor current can increase up to the current limit of the device so it is safe to choose an inductor with a saturation current higher than the peak current under current limit condition.

### 7.2.2.1.4 Output Capacitor Selection

After selecting the inductor, the output capacitor needs to be optimized. In DCAP3, the regulator reacts within one cycle to the change in the duty cycle so the good transient performance can be achieved without needing large amounts of output capacitance. The recommended output capacitance range is given in 表 7-2

Ceramic capacitors have very low ESR, otherwise the maximum ESR of the capacitor must be less than  $V_{OUT(ripple)}/I_{OUT(ripple)}$ .

表 7-2. Recommended Component Values

V <sub>OUT</sub> (V)	R <sub>LOWER</sub> (kΩ)	R <sub>UPPER</sub> (kΩ)	F <sub>SW</sub> (kHz)	L <sub>OUT</sub> (μH)	C <sub>OUT(min)</sub> (μF)	C <sub>OUT(max)</sub> (μF)	C <sub>FF</sub> (pF)
0.6	10	0	400	0.68	300	500	–
			800	0.47	100	500	–
			1200	0.33	88	500	–
1.2		10	400	1.2	100	500	–
			800	0.68	88	500	–
			1200	0.47	88	500	–
3.3		45.3	400	2.4	88	500	100–220
			800	1.5	88	500	100–220
			1200	1.2	88	500	100–220
5.5		82.5	400	3.3	88	500	100–220
			800	2.4	88	500	100–220
			1200	1.5	88	700	100–220

### 7.2.2.1.5 Input Capacitor Selection

The minimum input capacitance required is given in 式 9.

$$C_{IN(min)} = \frac{I_{OUT} \times V_{OUT}}{V_{IN(ripple)} \times V_{IN} \times F_{SW}} \quad (9)$$

TI recommends using a high quality X5R or X7R input decoupling capacitors of 40  $\mu$ F on the input voltage pin. The voltage rating on the input capacitor must be greater than the maximum input voltage. The capacitor must also have a ripple current rating greater than the maximum input current ripple of the application. The input ripple current is calculated by 式 10:

$$I_{CIN(rms)} = I_{OUT} \times \sqrt{\frac{V_{OUT}}{V_{IN(min)}} \times \frac{(V_{IN(min)} - V_{OUT})}{V_{IN(min)}}} \quad (10)$$

### 7.2.3 Application Curves

Figure 7-2 through Figure 7-18 apply to the circuit of Figure 7-1.  $V_{IN} = 12\text{ V}$ .  $T_a = 25^\circ\text{C}$  unless otherwise specified.

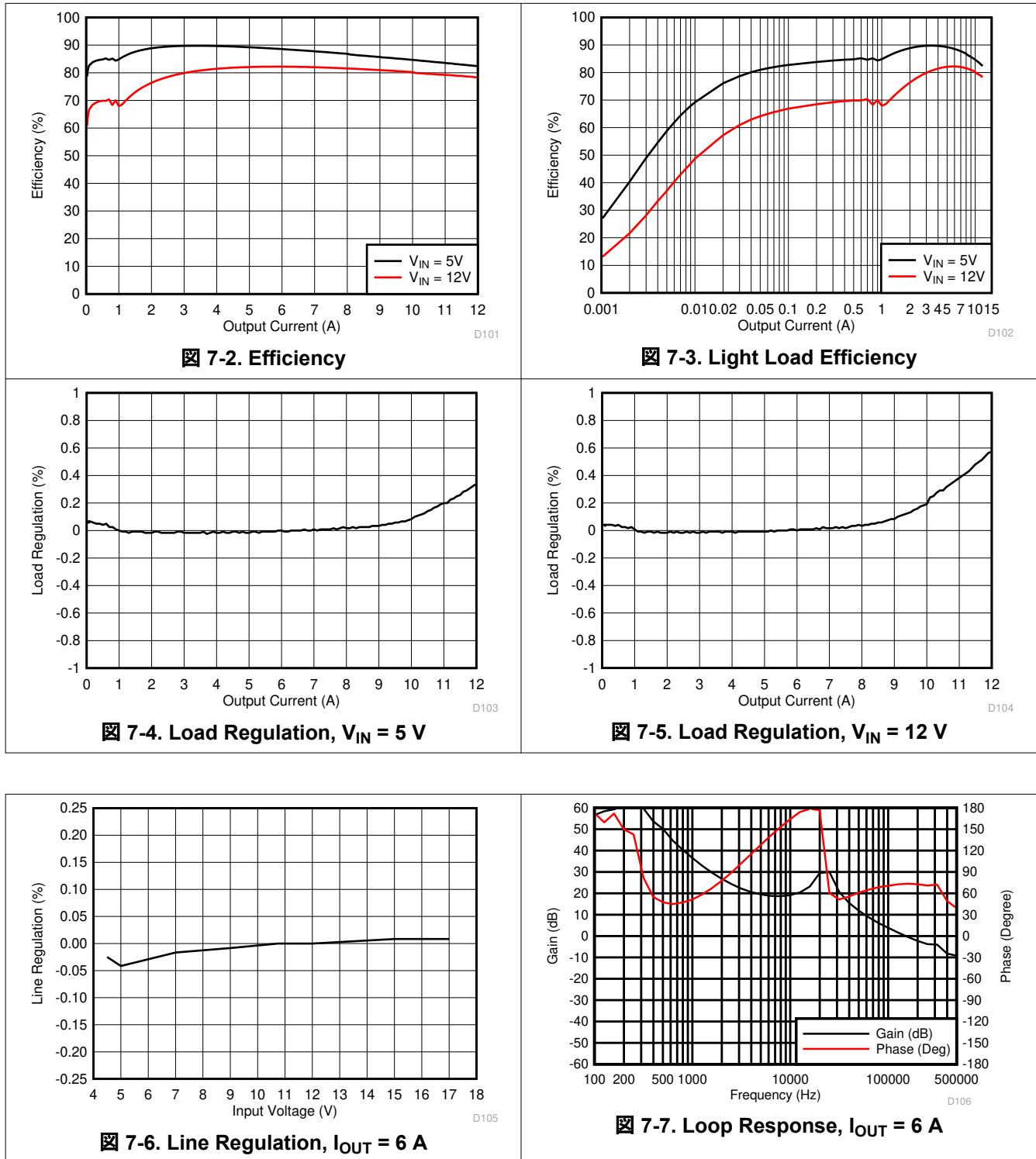



図 7-8. Input Voltage Ripple,  $I_{OUT} = 10 \text{ mA}$



図 7-9. Input Voltage Ripple,  $I_{OUT} = 800 \text{ mA}$

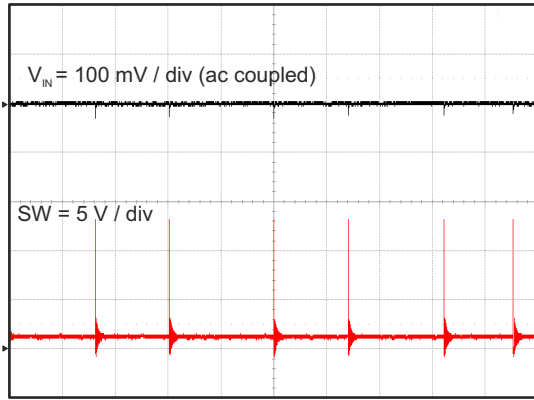

図 7-10. Input Voltage Ripple,  $I_{OUT} = 12 \text{ A}$

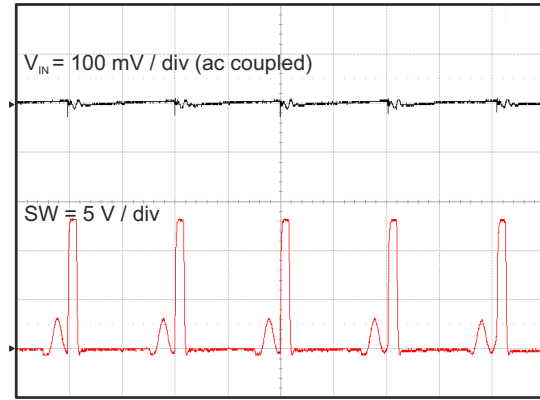

図 7-11. Output Voltage Ripple,  $I_{OUT} = 10 \text{ mA}$

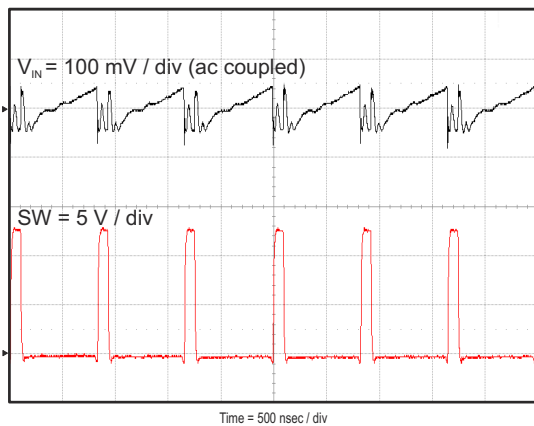

図 7-12. Output Voltage Ripple,  $I_{OUT} = 800 \text{ mA}$

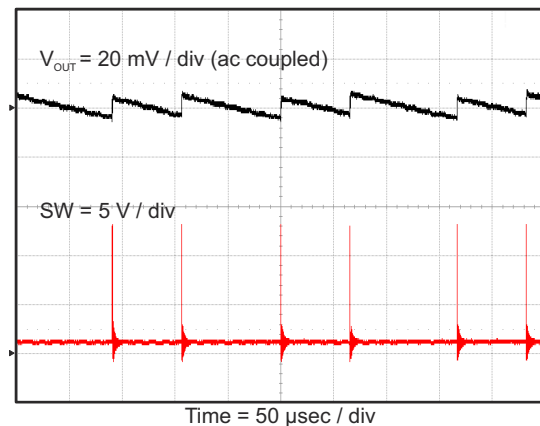

図 7-13. Output Voltage Ripple,  $I_{OUT} = 12 \text{ A}$



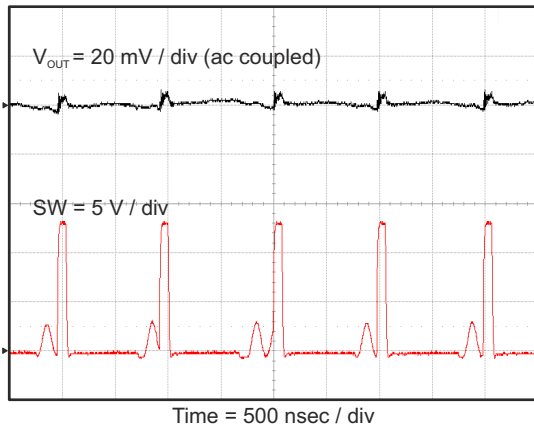

図 7-14. Start Up Relative to  $V_{IN}$  Rising

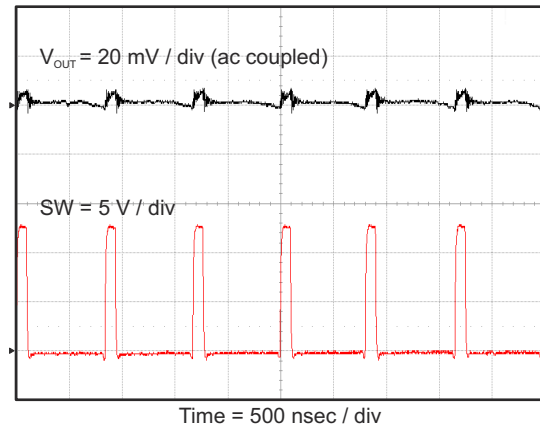

図 7-15. Start Up Relative to EN Rising

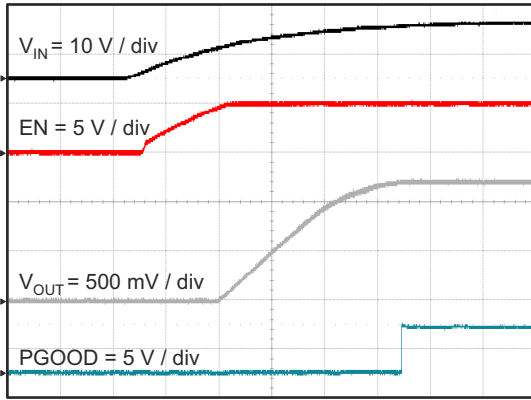

図 7-16. Shut Down Relative to  $V_{IN}$  Falling

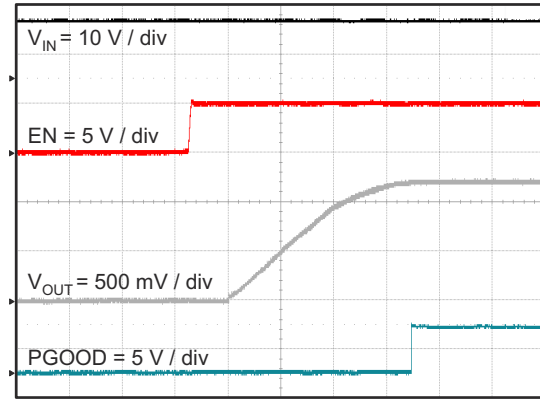

図 7-17. Shut Down Relative to EN Falling

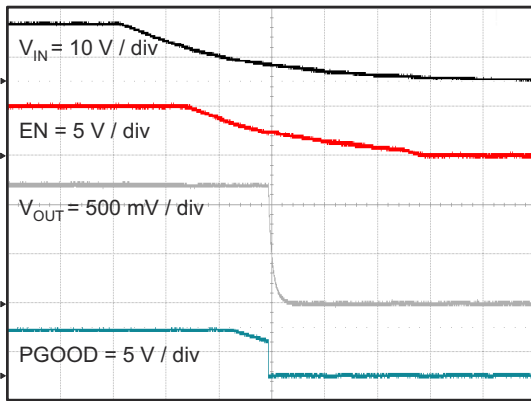

図 7-18. Transient Response

### 7.3 Power Supply Recommendations

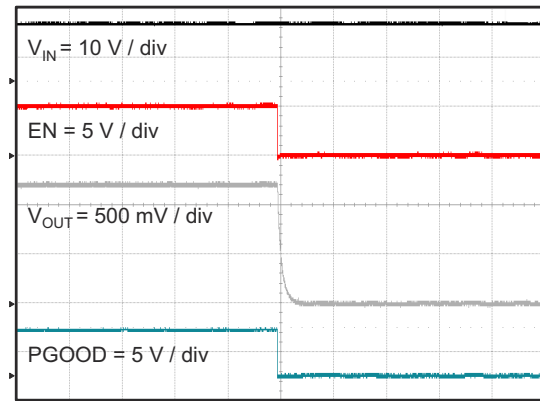
The TPS56C215 is intended to be powered by a well regulated dc voltage. The input voltage range is 3.8 to 17 V. TPS56C215 is a buck converter. The input supply voltage must be greater than the desired output voltage for proper operation. Input supply current must be appropriate for the desired output current. If the input voltage supply is located far from the TPS56215 circuit, some additional input bulk capacitance is recommended. Typical values are 100 µF to 470 µF.

## 7.4 Layout

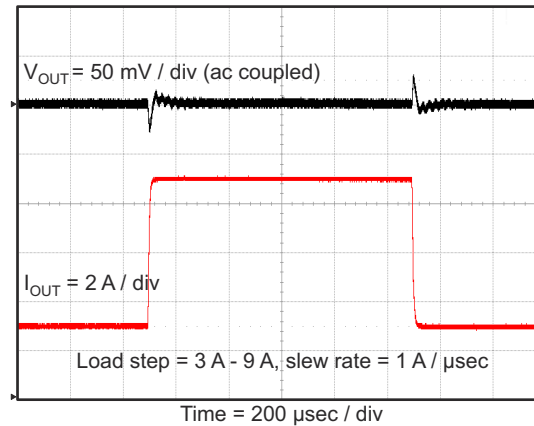
### 7.4.1 Layout Guidelines

- Recommend a four-layer or six-layer PCB for good thermal performance and with maximum ground plane. 3" × 3", four-layer PCB with 2-oz. copper used as example.
- Recommend having equal caps on each side of the IC. Place them right across VIN as close as possible.
- Inner layer 1 is ground with the PGND to AGND net tie
- Inner layer2 has VIN copper pour that has vias to the top layer VIN. *Place multiple vias under the device near VIN and PGND and near input capacitors* to reduce parasitic inductance and improve thermal performance
- Bottom later is GND with the BOOT trace routing.
- Reference feedback to the quite AGND and routed away from the switch node.
- Make VIN trace wide to reduce the trace impedance.

### 7.4.2 Layout Example

☒ 7-19 shows the recommended top side layout. Component reference designators are the same as the circuit shown in ☒ 7-1. Resistor divider for EN is not used in the circuit of ☒ 7-1, but are shown in the layout for reference.

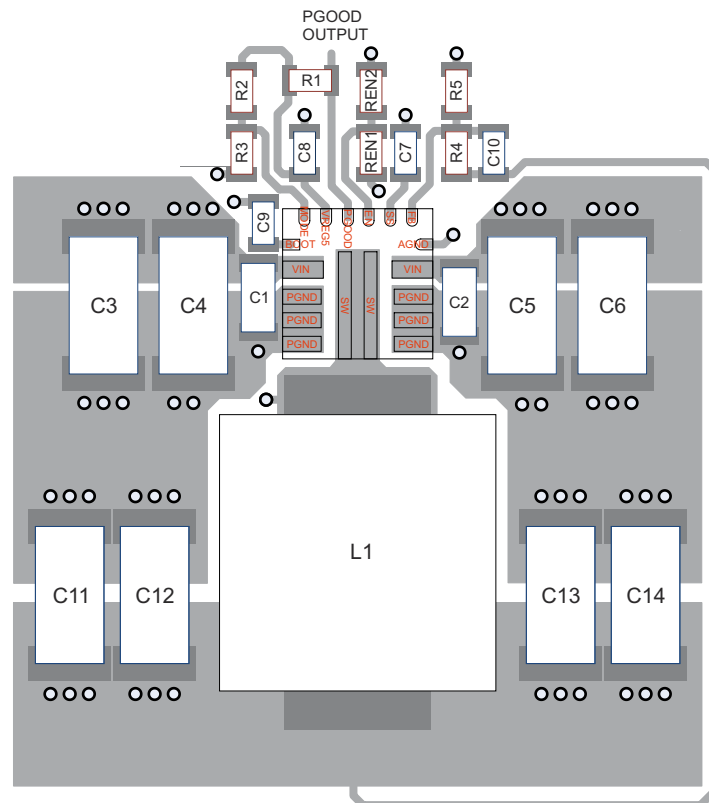

☒ 7-19. Top Side Layout

 **7-20** shows the recommended layout for the first internal layer. It is comprised of a large PGND plane and a smaller AGND island. AGND and PGND are connected at a single point to reduce circulating currents.

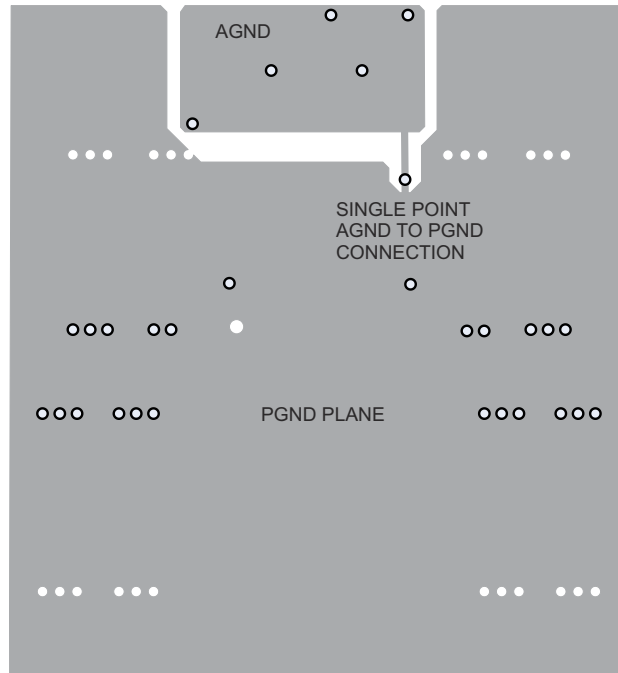

**図 7-20. Mid Layer 1 Layout**

 **7-21** shows the recommended layout for the second internal layer. It is comprised of a large PGND plane, a smaller copper fill area to connect the two top side  $V_{IN}$  copper areas and a second  $V_{OUT}$  copper fill area.

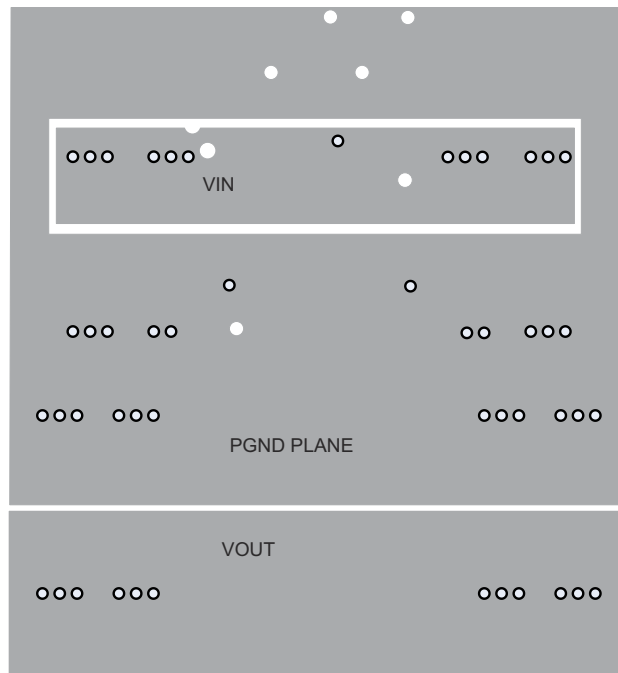

**図 7-21. Mid Layer 2 Layout**

☒ 7-22 shows the recommended layout for the bottom layer. It is comprised of a large PGND plane and a trace to connect the BOOT capacitor to the SW node.

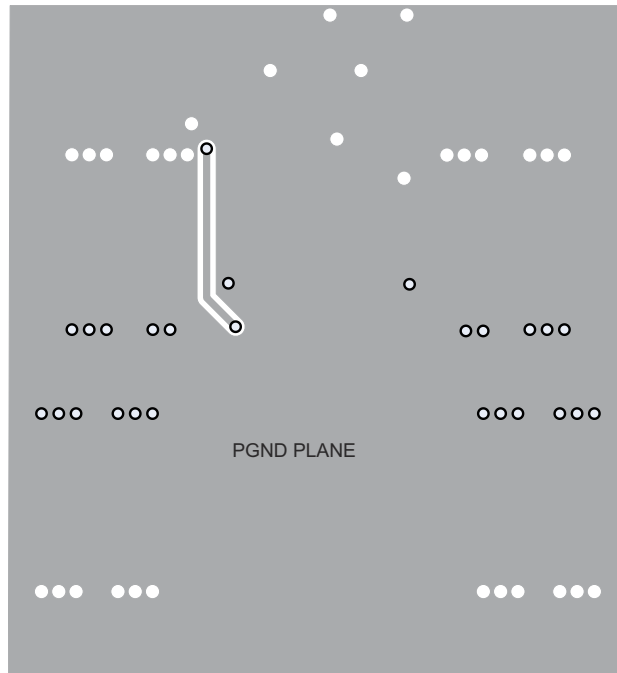

☒ 7-22. Bottom Layer Layout

## 8 Device and Documentation Support

### 8.1 Device Support

#### 8.1.1 サード・パーティ製品に関する免責事項

サード・パーティ製品またはサービスに関するテキサス・インスツルメンツの出版物は、単独またはテキサス・インスツルメンツの製品、サービスと一緒に提供される場合に関係なく、サード・パーティ製品またはサービスの適合性に関する是認、サード・パーティ製品またはサービスの是認の表明を意味するものではありません。

#### 8.1.2 Development Support

The evaluation module for system validation is shown in [図 8-1](#).

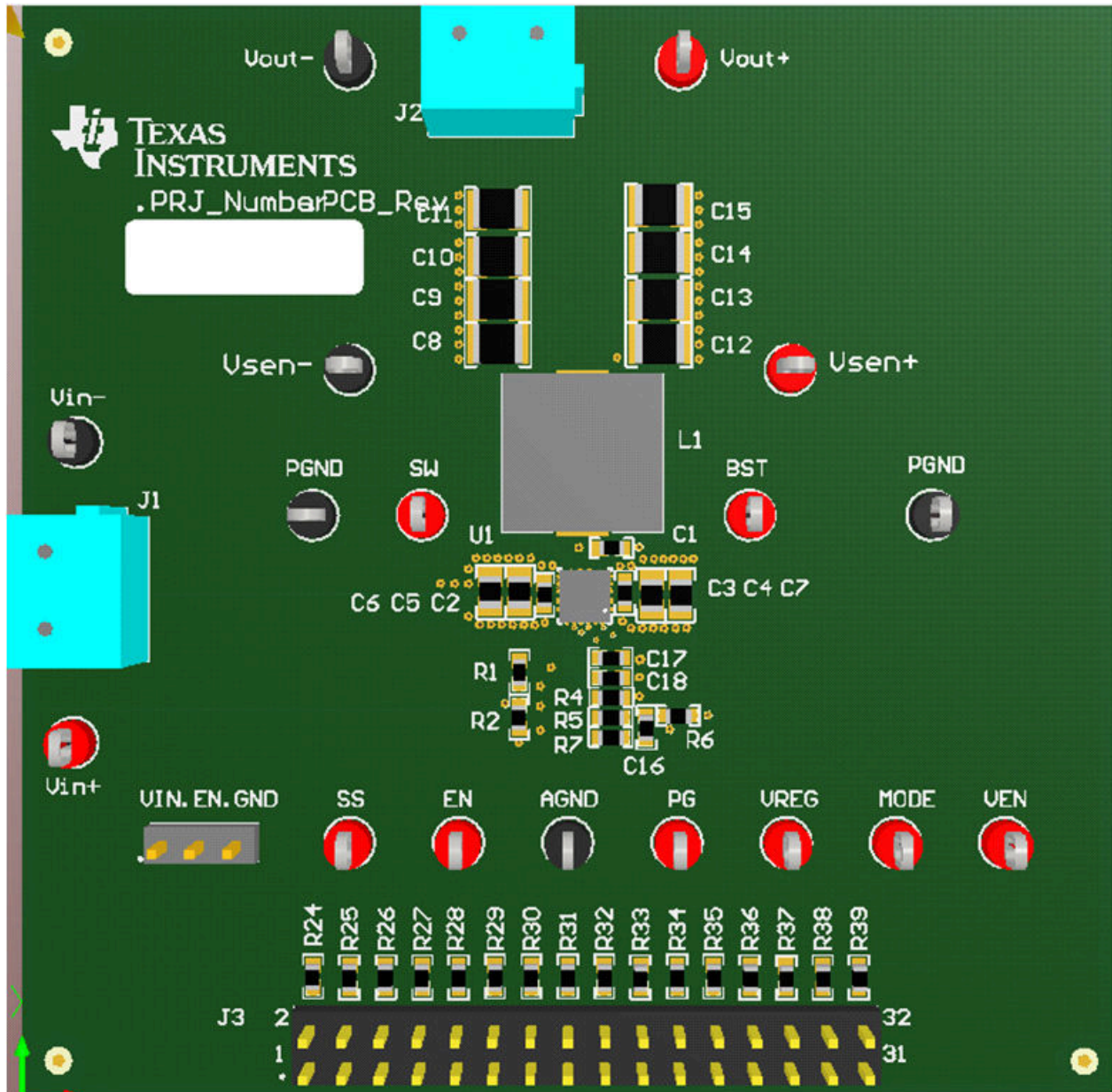

**図 8-1. System Validation EVM Board**

## 8.2 ドキュメントの更新通知を受け取る方法

ドキュメントの更新についての通知を受け取るには、[www.tij.co.jp](http://www.tij.co.jp) のデバイス製品フォルダを開いてください。[通知] をクリックして登録すると、変更されたすべての製品情報に関するダイジェストを毎週受け取ることができます。変更の詳細については、改訂されたドキュメントに含まれている改訂履歴をご覧ください。

## 8.3 サポート・リソース

テキサス・インスツルメンツ E2E™ サポート・フォーラムは、エンジニアが検証済みの回答と設計に関するヒントをエキスパートから迅速かつ直接得ることができる場所です。既存の回答を検索したり、独自の質問をしたりすることで、設計に必要な支援を迅速に得ることができます。

リンクされているコンテンツは、各寄稿者により「現状のまま」提供されるものです。これらはテキサス・インスツルメンツの仕様を構成するものではなく、必ずしもテキサス・インスツルメンツの見解を反映したものではありません。テキサス・インスツルメンツの[使用条件](#)を参照してください。

## 8.4 Trademarks

SWIFT™, D-CAP3™, HotRod™, and テキサス・インスツルメンツ E2E™ are trademarks of Texas Instruments. WEBENCH® is a registered trademark of Texas Instruments.

すべての商標は、それぞれの所有者に帰属します。

## 8.5 静電気放電に関する注意事項



この IC は、ESD によって破損する可能性があります。テキサス・インスツルメンツは、IC を取り扱う際には常に適切な注意を払うことを推奨します。正しい取り扱いおよび設置手順に従わない場合、デバイスを破損するおそれがあります。

ESD による破損は、わずかな性能低下からデバイスの完全な故障まで多岐にわたります。精密な IC の場合、パラメータがわずかに変化するだけで公表されている仕様から外れる可能性があるため、破損が発生しやすくなっています。

## 8.6 用語集

[テキサス・インスツルメンツ用語集](#) この用語集には、用語や略語の一覧および定義が記載されています。

## 9 Revision History

資料番号末尾の英字は改訂を表しています。その改訂履歴は英語版に準じています。

Changes from Revision F (August 2023) to Revision G (August 2024)	Page
• 製品ラインアップを更新し、説明を「テキサス・インスツルメンツ最小」から「小型」に変更。.....	1
• Deleted T <sub>SDN VREG5</sub> spec.....	5
• Added note "Specified by design" for the SW On Time parameter.....	6
• Deleted the <i>Out-of-Bounds Operation</i> section.....	13
• Updated the <i>Thermal Shutdown</i> section.....	19

Changes from Revision E (August 2023) to Revision F (August 2023)	Page
• 「特長」一覧にピン互換のデータシートのリンクを追加 .....	1

Changes from Revision D (February 2021) to Revision E (August 2023)	Page
• 「特長」一覧を、ピン互換デバイスで更新 .....	1

## 10 Mechanical, Packaging, and Orderable Information

The following pages include mechanical, packaging, and orderable information. This information is the most current data available for the designated devices. This data is subject to change without notice and revision of this document. For browser-based versions of this data sheet, refer to the left-hand navigation.

### 10.1 Package Marking

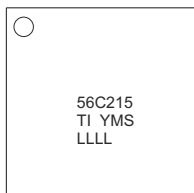

TI = TI Letters  
YM = Year Month Date Code  
S = Assembly Site Code  
LLLL = Assembly Lot Code  
  
Y : Year Code (1, 2, 3, 4, 5, 6, 7, 8, 9, 0)  
M : Month Code (1, 2, 3, 4, 5, 6, 7, 8, 9, 0, A, B, C)

#### 10-1. Symbolization

## 重要なお知らせと免責事項

テキサス・インスツルメンツは、技術データと信頼性データ (データシートを含みます)、設計リソース (リファレンス デザインを含みます)、アプリケーションや設計に関する各種アドバイス、Web ツール、安全性情報、その他のリソースを、欠陥が存在する可能性のある「現状のまま」提供しており、商品性および特定目的に対する適合性の黙示保証、第三者の知的財産権の非侵害保証を含むいかなる保証も、明示的または黙示的にかかわらず拒否します。

これらのリソースは、テキサス・インスツルメンツ製品を使用する設計の経験を積んだ開発者への提供を意図したものです。(1) お客様のアプリケーションに適した テキサス・インスツルメンツ製品の選定、(2) お客様のアプリケーションの設計、検証、試験、(3) お客様のアプリケーションに該当する各種規格や、その他のあらゆる安全性、セキュリティ、規制、または他の要件への確実な適合に関する責任を、お客様のみが単独で負うものとします。

上記の各種リソースは、予告なく変更される可能性があります。これらのリソースは、リソースで説明されている テキサス・インスツルメンツ製品を使用するアプリケーションの開発の目的でのみ、テキサス・インスツルメンツはその使用をお客様に許諾します。これらのリソースに関して、他の目的で複製することや掲載することは禁止されています。テキサス・インスツルメンツや第三者の知的財産権のライセンスが付与されている訳ではありません。お客様は、これらのリソースを自身で使用した結果発生するあらゆる申し立て、損害、費用、損失、責任について、テキサス・インスツルメンツおよびその代理人を完全に補償するものとし、テキサス・インスツルメンツは一切の責任を拒否します。

テキサス・インスツルメンツの製品は、[テキサス・インスツルメンツの販売条件](#)、または [ti.com](https://www.ti.com) やかかる テキサス・インスツルメンツ製品の関連資料などのいずれかを通じて提供する適用可能な条項の下で提供されています。テキサス・インスツルメンツがこれらのリソースを提供することは、適用されるテキサス・インスツルメンツの保証または他の保証の放棄の拡大や変更を意味するものではありません。

お客様がいかなる追加条項または代替条項を提案した場合でも、テキサス・インスツルメンツはそれらに異議を唱え、拒否します。

郵送先住所: Texas Instruments, Post Office Box 655303, Dallas, Texas 75265

Copyright © 2024, Texas Instruments Incorporated



**PACKAGING INFORMATION**

Orderable Device	Status (1)	Package Type	Package Drawing	Pins	Package Qty	Eco Plan (2)	Lead finish/ Ball material (6)	MSL Peak Temp (3)	Op Temp (°C)	Device Marking (4/5)	Samples
TPS56C215RNNR	ACTIVE	VQFN-HR	RNN	18	3000	RoHS & Green	Call TI   SN	Level-2-260C-1 YEAR	-40 to 125	56C215	<a href="#">Samples</a>
TPS56C215RNNT	ACTIVE	VQFN-HR	RNN	18	250	RoHS & Green	Call TI   SN	Level-2-260C-1 YEAR	-40 to 125	56C215	<a href="#">Samples</a>

(1) The marketing status values are defined as follows:

**ACTIVE:** Product device recommended for new designs.

**LIFEBUY:** TI has announced that the device will be discontinued, and a lifetime-buy period is in effect.

**NRND:** Not recommended for new designs. Device is in production to support existing customers, but TI does not recommend using this part in a new design.

**PREVIEW:** Device has been announced but is not in production. Samples may or may not be available.

**OBSOLETE:** TI has discontinued the production of the device.

(2) **RoHS:** TI defines "RoHS" to mean semiconductor products that are compliant with the current EU RoHS requirements for all 10 RoHS substances, including the requirement that RoHS substance do not exceed 0.1% by weight in homogeneous materials. Where designed to be soldered at high temperatures, "RoHS" products are suitable for use in specified lead-free processes. TI may reference these types of products as "Pb-Free".

**RoHS Exempt:** TI defines "RoHS Exempt" to mean products that contain lead but are compliant with EU RoHS pursuant to a specific EU RoHS exemption.

**Green:** TI defines "Green" to mean the content of Chlorine (Cl) and Bromine (Br) based flame retardants meet JS709B low halogen requirements of <=1000ppm threshold. Antimony trioxide based flame retardants must also meet the <=1000ppm threshold requirement.

(3) MSL, Peak Temp. - The Moisture Sensitivity Level rating according to the JEDEC industry standard classifications, and peak solder temperature.

(4) There may be additional marking, which relates to the logo, the lot trace code information, or the environmental category on the device.

(5) Multiple Device Markings will be inside parentheses. Only one Device Marking contained in parentheses and separated by a "~" will appear on a device. If a line is indented then it is a continuation of the previous line and the two combined represent the entire Device Marking for that device.

(6) Lead finish/Ball material - Orderable Devices may have multiple material finish options. Finish options are separated by a vertical ruled line. Lead finish/Ball material values may wrap to two lines if the finish value exceeds the maximum column width.

**Important Information and Disclaimer:**The information provided on this page represents TI's knowledge and belief as of the date that it is provided. TI bases its knowledge and belief on information provided by third parties, and makes no representation or warranty as to the accuracy of such information. Efforts are underway to better integrate information from third parties. TI has taken and continues to take reasonable steps to provide representative and accurate information but may not have conducted destructive testing or chemical analysis on incoming materials and chemicals. TI and TI suppliers consider certain information to be proprietary, and thus CAS numbers and other limited information may not be available for release.

In no event shall TI's liability arising out of such information exceed the total purchase price of the TI part(s) at issue in this document sold by TI to Customer on an annual basis.



**TAPE AND REEL INFORMATION**

**QUADRANT ASSIGNMENTS FOR PIN 1 ORIENTATION IN TAPE**



\*All dimensions are nominal

Device	Package Type	Package Drawing	Pins	SPQ	Reel Diameter (mm)	Reel Width W1 (mm)	A0 (mm)	B0 (mm)	K0 (mm)	P1 (mm)	W (mm)	Pin1 Quadrant
TPS56C215RNNT	VQFN-HR	RNN	18	250	180.0	12.4	3.75	3.75	1.15	8.0	12.0	Q1
TPS56C215RNNT	VQFN-HR	RNN	18	250	180.0	12.4	3.75	3.75	1.15	8.0	12.0	Q1

**TAPE AND REEL BOX DIMENSIONS**

\*All dimensions are nominal

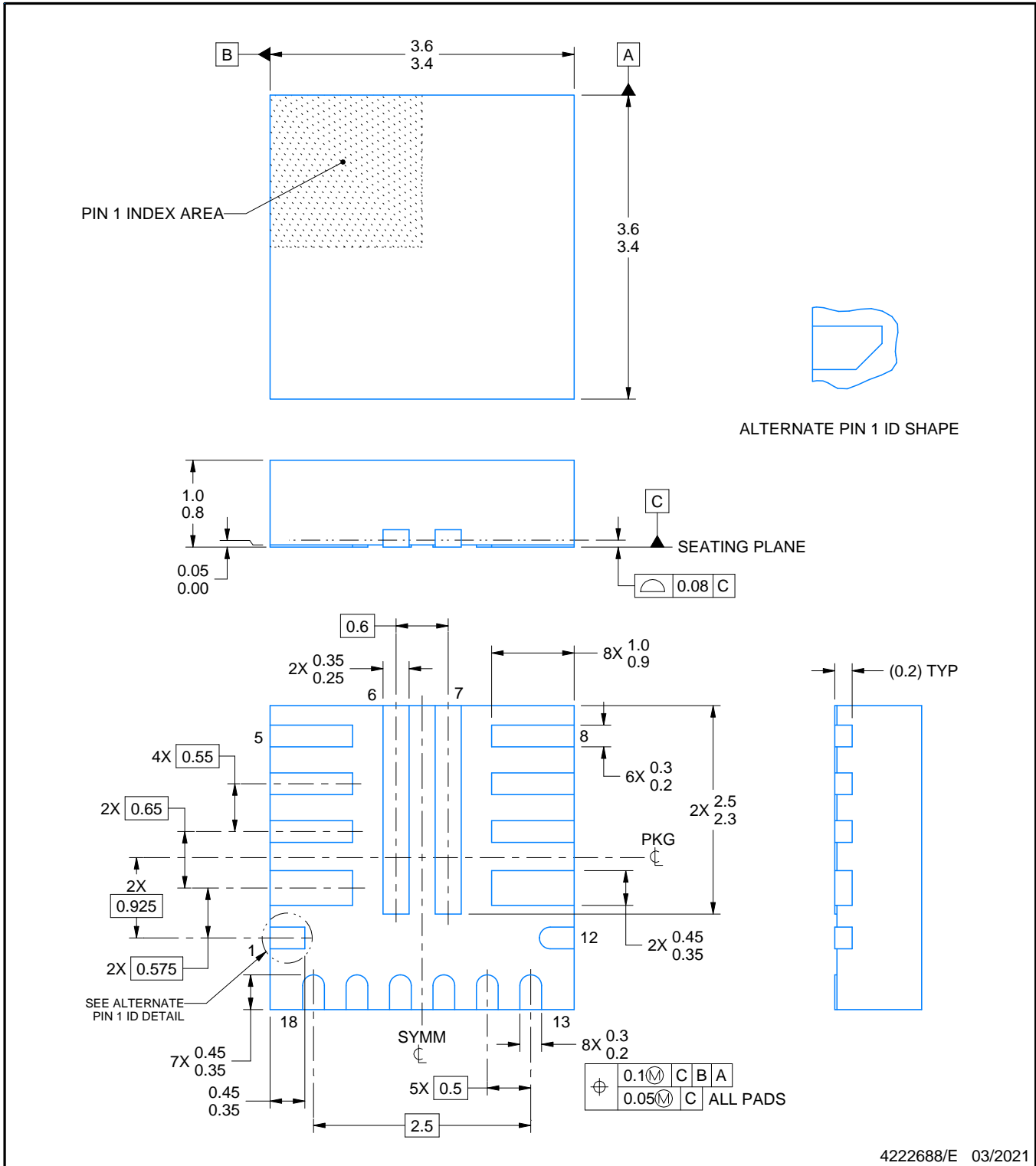
Device	Package Type	Package Drawing	Pins	SPQ	Length (mm)	Width (mm)	Height (mm)
TPS56C215RNNT	VQFN-HR	RNN	18	250	213.0	191.0	35.0
TPS56C215RNNT	VQFN-HR	RNN	18	250	210.0	185.0	35.0



**NOTES:**

1. All linear dimensions are in millimeters. Any dimensions in parenthesis are for reference only. Dimensioning and tolerancing per ASME Y14.5M.
2. This drawing is subject to change without notice.

# EXAMPLE BOARD LAYOUT

RNN0018A

VQFN-HR - 1 mm max height

PLASTIC QUAD FLATPACK - NO LEAD

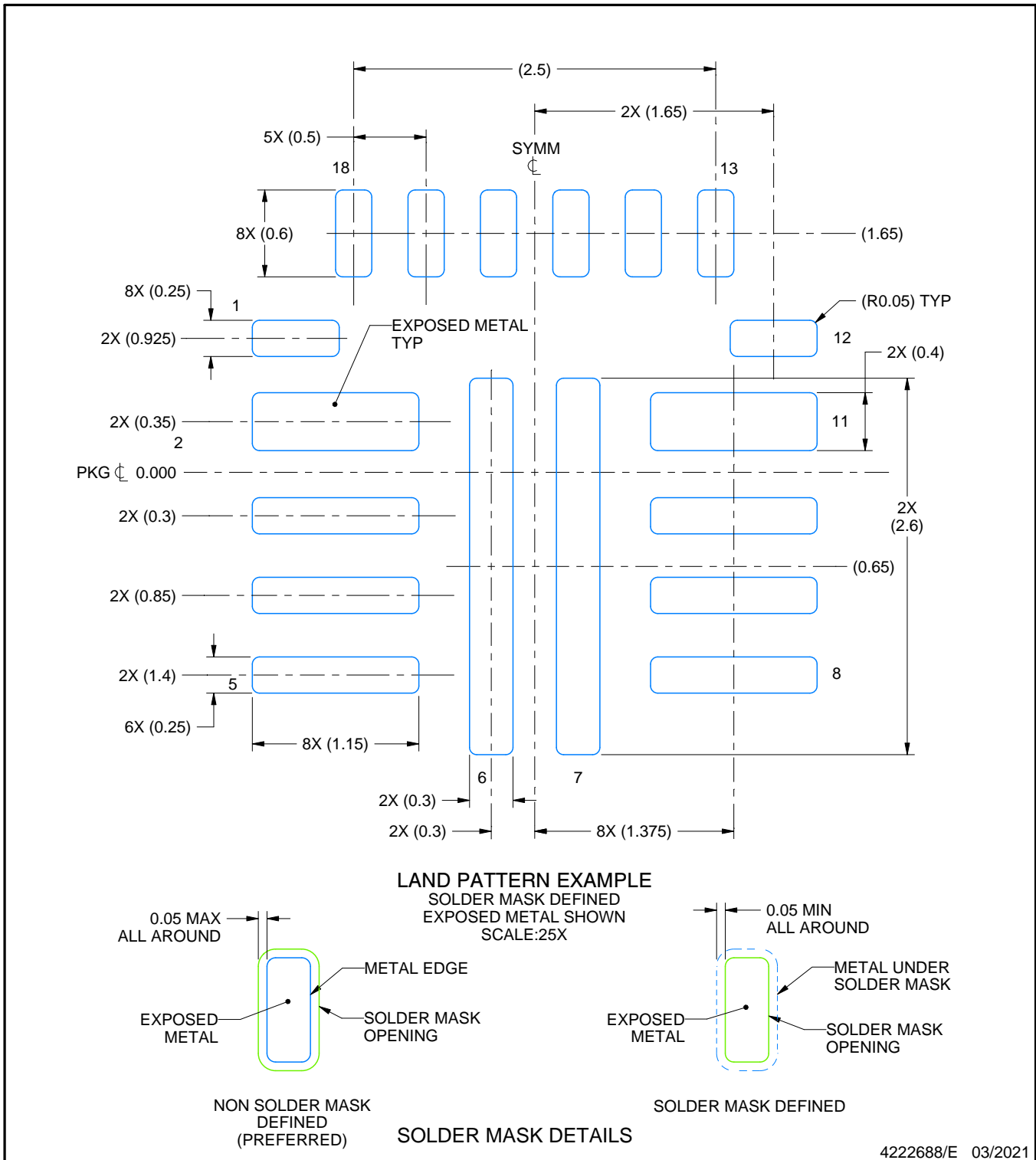

4222688/E 03/2021

NOTES: (continued)

- This package is designed to be soldered to a thermal pad on the board. For more information, see Texas Instruments literature number SLUA271 ([www.ti.com/lit/slue271](http://www.ti.com/lit/slue271)).
- Solder mask tolerances between and around signal pads can vary based on board fabrication site.

# EXAMPLE STENCIL DESIGN

RNN0018A

VQFN-HR - 1 mm max height

PLASTIC QUAD FLATPACK - NO LEAD

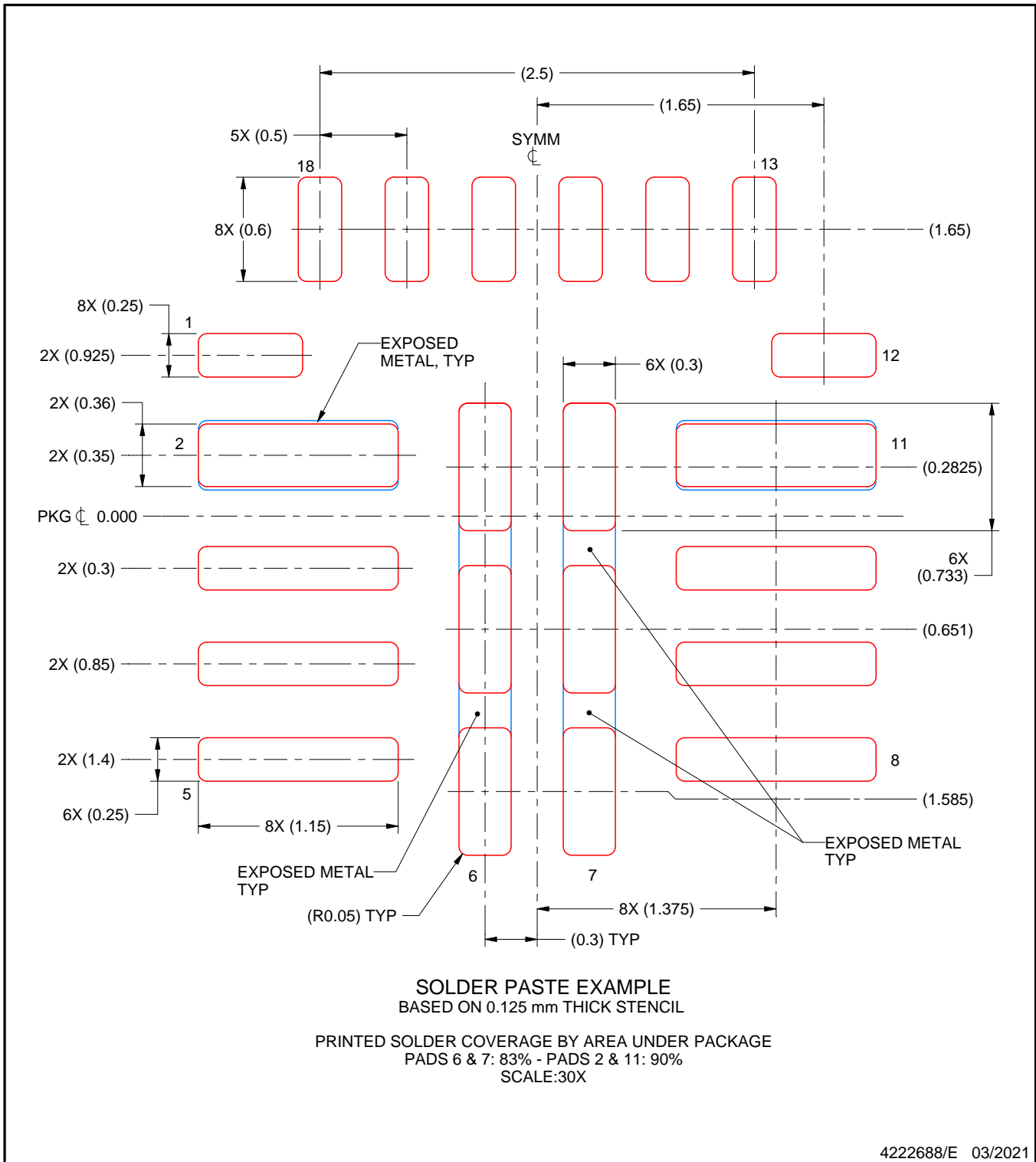

NOTES: (continued)

5. For alternate stencil design recommendations, see IPC-7525 or board assembly site preference.

## 重要なお知らせと免責事項

TI は、技術データと信頼性データ（データシートを含みます）、設計リソース（リファレンス・デザインを含みます）、アプリケーションや設計に関する各種アドバイス、Web ツール、安全性情報、その他のリソースを、欠陥が存在する可能性のある「現状のまま」提供しており、商品性および特定目的に対する適合性の黙示保証、第三者の知的財産権の非侵害保証を含むいかなる保証も、明示的または黙示的にかかわらず拒否します。

これらのリソースは、TI 製品を使用する設計の経験を積んだ開発者への提供を意図したものです。(1) お客様のアプリケーションに適した TI 製品の選定、(2) お客様のアプリケーションの設計、検証、試験、(3) お客様のアプリケーションに該当する各種規格や、その他のあらゆる安全性、セキュリティ、規制、または他の要件への確実な適合に関する責任を、お客様のみが単独で負うものとします。

上記の各種リソースは、予告なく変更される可能性があります。これらのリソースは、リソースで説明されている TI 製品を使用するアプリケーションの開発の目的でのみ、TI はその使用をお客様に許諾します。これらのリソースに関して、他の目的で複製することや掲載することは禁止されています。TI や第三者の知的財産権のライセンスが付与されている訳ではありません。お客様は、これらのリソースを自身で使用した結果発生するあらゆる申し立て、損害、費用、損失、責任について、TI およびその代理人を完全に補償するものとし、TI は一切の責任を拒否します。

TI の製品は、[TI の販売条件](#)、または [ti.com](#) やかかる TI 製品の関連資料などのいずれかを通じて提供する適用可能な条項の下で提供されています。TI がこれらのリソースを提供することは、適用される TI の保証または他の保証の放棄の拡大や変更を意味するものではありません。

お客様がいかなる追加条項または代替条項を提案した場合でも、TI はそれらに異議を唱え、拒否します。

郵送先住所：Texas Instruments, Post Office Box 655303, Dallas, Texas 75265  
Copyright © 2024, Texas Instruments Incorporated