

# TPS56320x 4.2V~17V 入力、3A、同期整流型降圧コンバータ、SOT563 パッケージ

## 1 特長

- 多様なアプリケーションに適した構成
  - 入力電圧範囲: 4.2V~17V
  - 出力電圧範囲: 0.6V~7V
  - 基準電圧: 0.6V
  - 25°C で  $\pm 1.5\%$  の基準電圧精度
  - 40°C~125°C で  $\pm 2\%$  の基準電圧精度
  - 100m $\Omega$  および 55m $\Omega$  FET を内蔵
  - TPS563203 の低静止時電流: 110 $\mu$ A
  - スイッチング周波数: 600kHz
  - 最大 95% の高デューティサイクル動作
  - 固定ソフトスタート時間: 1.4ms
- 使いやすく小さい設計サイズ
  - TPS563203 の軽負荷時の Eco-mode
  - TPS563206 の軽負荷時の FCCM モード
  - 高速過渡応答の D-CAP3™ 制御モード
  - あらかじめ出力にバイアスが印加された状態でのスタートアップをサポート
  - ラッチなしの OT および UVLO 保護
  - サイクル単位の過電流制限
  - ヒックアップモードによる UV 保護
  - 動作時の接合部温度範囲: -40°C~125°C
  - SOT563 パッケージ、1.6mm x 1.6mm
- [WEBENCH® Power Designer](#) により、TPS563203 を使用するカスタム設計を作成
- [WEBENCH® Power Designer](#) により、TPS563206 を使用するカスタム設計を作成

## 2 アプリケーション

- テレビ
- デジタル・セットトップ・ボックス (STB)
- ビルディング・オートメーション
- ブロードバンド固定回線アクセス

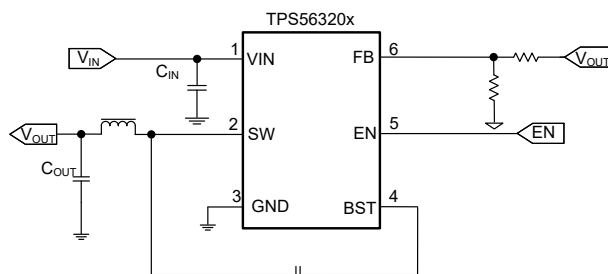

概略回路図

## 3 概要

TPS563203、TPS563206 は単純で使いやすい 3A 同期整流型降圧コンバータで、SOT563 パッケージに搭載されています。

最小の外部部品数で動作し、スタンバイ電流が小さくなるよう設計されています。

このスイッチモード電源 (SMPS) デバイスは、D-CAP3 制御モードを採用し、高速の過渡応答を実現します。また、特殊ポリマーなど ESR (等価直列抵抗) の低い出力コンデンサと、超低 ESR のセラミックコンデンサの両方を、外部補償部品なしでサポートします。

TPS563203 は Eco-mode で動作することで、軽負荷動作中も高い効率を維持します。TPS563206 は FCCM モードで動作することで、すべての負荷条件で同じ周波数と小さい出力リップルを維持します。このデバイスは、OCP、UVLO、OTP、UVP (ヒックアップ機能付き) による完全な保護機能を備えています。TPS56320x は 6 ピン、1.6mm x 1.6mm の SOT563 (DRL) パッケージで供給され、接合部温度 -40°C~125°C で動作が規定されています。

### 製品情報

部品番号	モード	パッケージ <sup>(1)</sup>	パッケージサイズ <sup>(2)</sup>
TPS563203	Eco	DRL (SOT563, 6)	1.60mm x 1.60mm
TPS563206	FCCM		

- 詳細については、[セクション 10](#) を参照してください。
- パッケージサイズ (長さ×幅) は公称値であり、該当する場合はピンも含まれます。

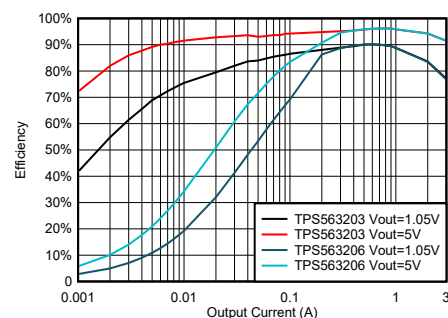

TPS563203 と TPS563206 の効率



## Table of Contents

<b>1 特長</b> .....	<b>1</b>	<b>7 Application and Implementation</b> .....	<b>15</b>
<b>2 アプリケーション</b> .....	<b>1</b>	7.1 Application Information.....	15
<b>3 概要</b> .....	<b>1</b>	7.2 Typical Application.....	15
<b>4 Pin Configuration and Functions</b> .....	<b>3</b>	7.3 Power Supply Recommendations.....	20
<b>5 Specifications</b> .....	<b>4</b>	7.4 Layout.....	20
5.1 Absolute Maximum Ratings.....	4	<b>8 Device and Documentation Support</b> .....	<b>22</b>
5.2 ESD Ratings.....	4	8.1 Device Support.....	22
5.3 Recommended Operating Conditions.....	4	8.2 ドキュメントの更新通知を受け取る方法.....	22
5.4 Thermal Information.....	5	8.3 サポート・リソース.....	22
5.5 Electrical Characteristics.....	5	8.4 Trademarks.....	22
5.6 Typical Characteristics.....	7	8.5 静電気放電に関する注意事項.....	22
<b>6 Detailed Description</b> .....	<b>11</b>	8.6 用語集.....	22
6.1 Overview.....	11	<b>9 Revision History</b> .....	<b>23</b>
6.2 Functional Block Diagram.....	11	<b>10 Mechanical, Packaging, and Orderable Information</b> .....	<b>23</b>
6.3 Feature Description.....	11		
6.4 Device Functional Modes.....	13		

## 4 Pin Configuration and Functions



図 4-1. 6-Pin SOT563 DRL Package (Top View)

表 4-1. Pin Functions

PIN		TYPE	DESCRIPTION
NAME	NO.		
VIN	1	I	Input voltage supply pin
SW	2	O	Switch node connection between high-side NFET and low-side NFET
GND	3	—	Ground pin source terminal of low-side power NFET as well as the ground terminal for controller circuit. Connect sensitive FB to this GND at a single point.
BST	4	O	Supply input for the high-side NFET gate drive circuit. Connect a 0.1- $\mu$ F capacitor between the BST and SW pin.
EN	5	I	Enable input control. Active high and must be pulled up to enable the device.
FB	6	I	Converter feedback input. Connect to output voltage with feedback resistor divider.

## 5 Specifications

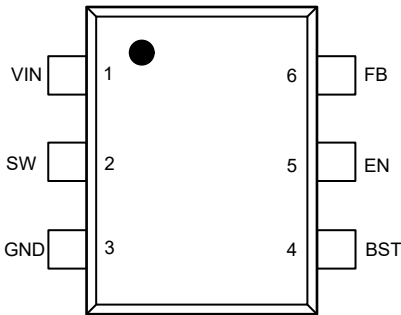
### 5.1 Absolute Maximum Ratings

over operating free-air temperature range (unless otherwise noted)<sup>(1)</sup>

		MIN	MAX	UNIT
Input voltage	VIN	-0.3	18	V
Input voltage	FB, EN	-0.3	6	V
Input voltage	GND	-0.3	0.3	V
Output voltage	BST	-0.3	25	V
Output voltage	BST (< 20ns)	-0.3	27	V
Output voltage	SW	-2	18	V
Output voltage	SW (< 20ns)	-6.5	20	V
Operating Junction Temperature Range, T <sub>J</sub>		-40	150	°C
Storage temperature, T <sub>stg</sub>	Storage temperature, T <sub>stg</sub>	-55	150	°C

- (1) Operation outside the Absolute Maximum Ratings may cause permanent device damage. Absolute Maximum Ratings do not imply functional operation of the device at these or any other conditions beyond those listed under Recommended Operating Conditions. If used outside the Recommended Operating Conditions but within the Absolute Maximum Ratings, the device may not be fully functional, and this may affect device reliability, functionality, performance, and shorten the device lifetime.

### 5.2 ESD Ratings

			VALUE	UNIT
V <sub>(ESD)</sub>	Electrostatic discharge	Human body model (HBM), per ANSI/ESDA/JEDEC JS-001 <sup>(1)</sup>	±2000	V
		Charged device model (CDM), per ANSI/ESDA/JEDEC JS-002 <sup>(2)</sup>	±500	

- (1) JEDEC document JEP155 states that 500V HBM allows safe manufacturing with a standard ESD control process.  
(2) JEDEC document JEP157 states that 250V CDM allows safe manufacturing with a standard ESD control process.

### 5.3 Recommended Operating Conditions

over operating free-air temperature range (unless otherwise noted)

		MIN	NOM	MAX	UNIT
Input voltage	VIN	4.2		17	V
Input voltage	FB, EN	-0.1		5.5	V
Input voltage	GND	-0.1		0.1	V
Output voltage	BST	-0.1		23	V
Output voltage	BST (< 20ns)	-0.1		25	V
Output voltage	SW	-1		17	V
Output voltage	SW (< 20ns)	-6		19	V
Output Current	IO	0		3	A
T <sub>J</sub>	Operating junction temperature	-40		125	°C
T <sub>stg</sub>	Storage temperature	-40		150	°C

## 5.4 Thermal Information

THERMAL METRIC <sup>(1)</sup>		DRL (SOT-563)	UNIT
		6 PINS	
R <sub>θJA</sub>	Junction-to-ambient thermal resistance	147.4	°C/W
R <sub>θJA_effective</sub>	Junction-to-ambient thermal resistance on EVM board	73 <sup>(2)</sup>	°C/W
R <sub>θJC(top)</sub>	Junction-to-case (top) thermal resistance	75.7	°C/W
R <sub>θJB</sub>	Junction-to-board thermal resistance	32.2	°C/W
Ψ <sub>JT</sub>	Junction-to-top characterization parameter	2.1	°C/W
Ψ <sub>JB</sub>	Junction-to-board characterization parameter	31.8	°C/W
R <sub>θJC(bot)</sub>	Junction-to-case (bottom) thermal resistance	N/A	°C/W

- (1) For more information about traditional and new thermal metrics, see the [Semiconductor and IC Package Thermal Metrics](#) application report.
- (2) This R<sub>θJA\_effective</sub> is tested on TPS563203EVM board (2 layer, copper thickness of top and bottom layer are 2oz) at Vin = 12V, Vout = 5V, Iout = 3A, TA = 25°C.

## 5.5 Electrical Characteristics

Over operating T<sub>J</sub> = -40°C – 125°C, V<sub>Vin</sub> = 12V (unless otherwise noted)

PARAMETER		TEST CONDITIONS	MIN	TYP	MAX	UNIT
<b>INPUT SUPPLY VOLTAGE</b>						
V <sub>in</sub>	Input voltage range		4.2		17	V
I <sub>Vin</sub>	Vin supply current	No load, V <sub>EN</sub> = 5V, non-switching, PSM version		110		μA
		No load, V <sub>EN</sub> = 5V, VFB = 0.7V, FCCM version		350		μA
I <sub>InSdn</sub>	Vin shutdown current	V <sub>EN</sub> = 0V		7		μA
<b>UVLO</b>						
UVLO	Vin undervoltage lockout	Wake up VIN voltage	3.6	3.8	4	V
UVLO	Vin undervoltage lockout	Shut down VIN voltage	3.2	3.4	3.6	V
UVLO	Vin undervoltage lockout	Hysteresis VIN voltage		400		mV
<b>FEEDBACK VOLTAGE</b>						
VFB	FB voltage	T <sub>J</sub> = 25°C, Vin = 4.2 – 17V	591	600	609	mV
VFB	FB voltage	T <sub>J</sub> = -40°C to 125°C, Vin = 4.2 – 17V	588	600	612	mV
<b>MOSFET</b>						
R <sub>DS(on)Hi</sub>	High-side MOSFET Rds(on)	T <sub>J</sub> = 25°C		100		mΩ
R <sub>DS(on)Lo</sub>	Low-side MOSFET Rds(on)	T <sub>J</sub> = 25°C		55		mΩ
<b>DUTY CYCLE and FREQUENCY CONTROL</b>						
F <sub>SW</sub>	Switching frequency	V <sub>VOUT</sub> = 3.3V		600		kHz
T <sub>OFF(Min)</sub>	Minimum off-time <sup>(1)</sup>	V <sub>FB</sub> = 0.5V		100		ns
T <sub>ON(Min)</sub>	Minimum on-time <sup>(1)</sup>			55		ns
<b>CURRENT LIMIT</b>						
I <sub>OCL_LS</sub>	Over current threshold	Valley current set point	3	3.9	4.8	A
I <sub>NOCL</sub>	Negative over current threshold	Valley current set point	0.7	1.3	1.9	A
<b>LOGIC THRESHOLD</b>						
V <sub>EN(On)</sub>	EN threshold high-level		1.15	1.21	1.27	V
V <sub>EN(Off)</sub>	EN threshold low-level		0.95	1.00	1.05	V
V <sub>ENHys</sub>	EN hysteresis			200		mV
<b>OUTPUT DISCHARGE and SOFT START</b>						

## 5.5 Electrical Characteristics (続き)

Over operating  $T_J = -40^\circ\text{C} - 125^\circ\text{C}$ ,  $V_{in} = 12\text{V}$  (unless otherwise noted)

PARAMETER		TEST CONDITIONS	MIN	TYP	MAX	UNIT
I <sub>EN</sub>	EN pulldown current	VEN = 1.5V		1		uA
t <sub>SS</sub>	Internal soft-start time	Vout from 0 to target value.		1.4		ms
<b>OUTPUT UNDERVOLTAGE AND OVERVOLTAGE PROTECTION</b>						
V <sub>UVP</sub>	UVP trip threshold		55	60	65	%
t <sub>UVPDly</sub>	UVP prop deglitch			256		us
t <sub>UVPOn</sub>	In continuous hiccup mode, the switching time	Hard short, UVP detect		1.5		ms
t <sub>UVPOff</sub>	In continuous hiccup mode, non-switching time	Hard short, UVP detect		13		ms
<b>THERMAL PROTECTION</b>						
T <sub>OTP</sub>	OTP trip threshold			155		°C
T <sub>OTPHsy</sub>	OTP hysteresis			20		°C

(1) Specified by design

## 5.6 Typical Characteristics

$V_{IN} = 12\text{ V}$  (unless otherwise noted)

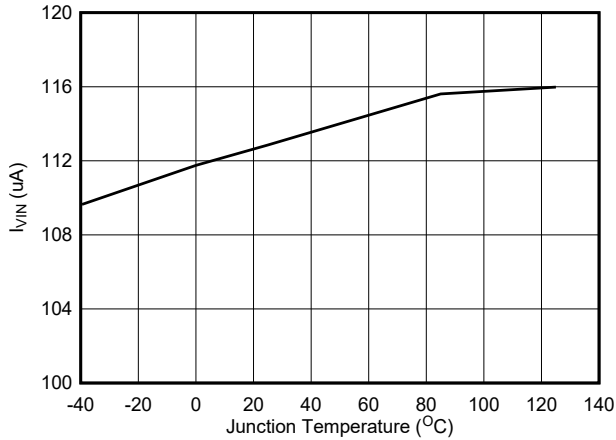

Figure 5-1. TPS563203 Quiescent Current

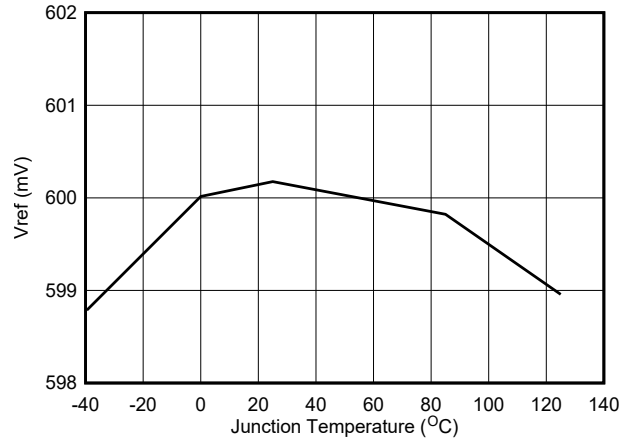

Figure 5-2. Vref Voltage

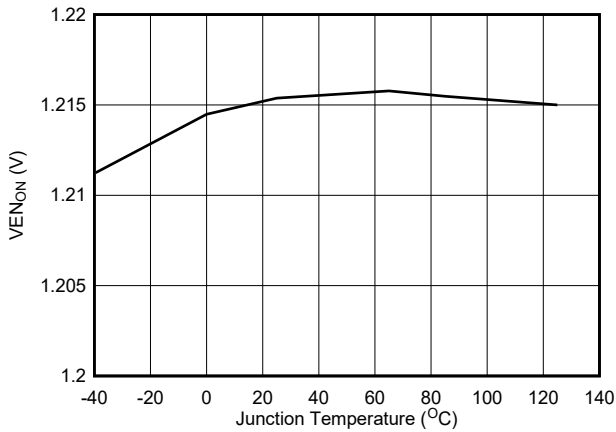

Figure 5-3. Enable On Threshold Voltage

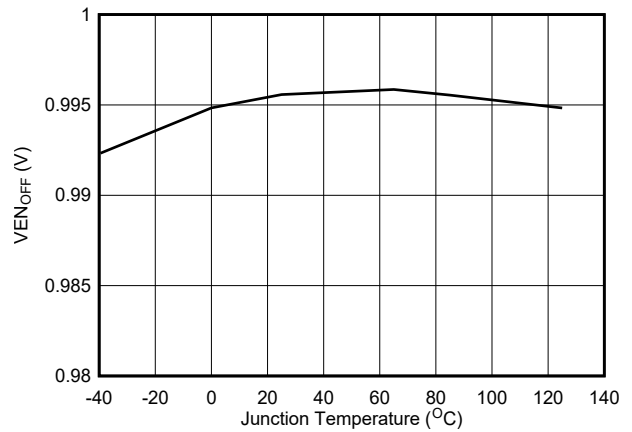

Figure 5-4. Enable Off Threshold Voltage

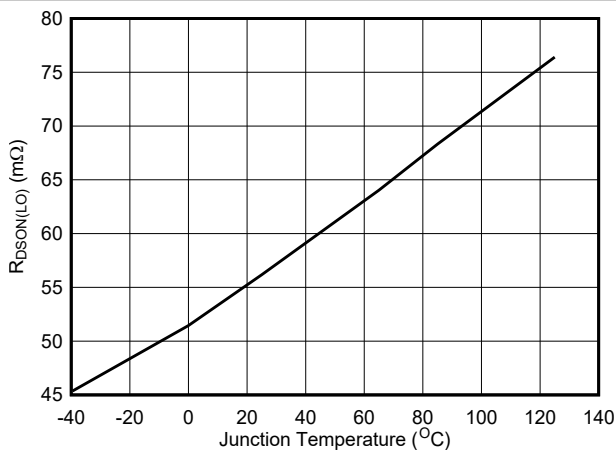

Figure 5-5. Low-Side  $R_{dson}$

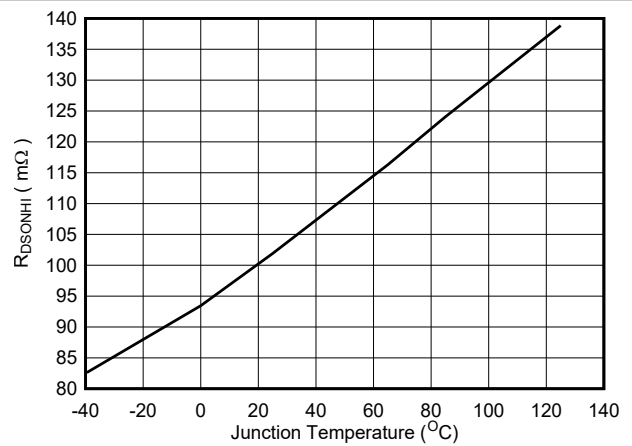
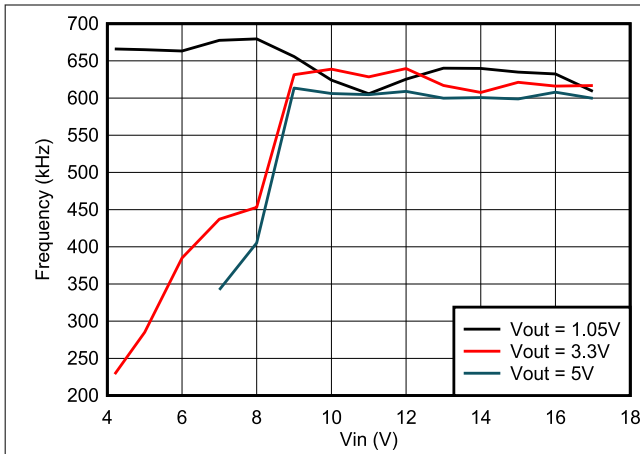

Figure 5-6. High-Side  $R_{dson}$

## 5.6 Typical Characteristics (continued)

$V_{IN} = 12\text{ V}$  (unless otherwise noted)



5-7. Frequency vs Input Voltage at 3A Loading

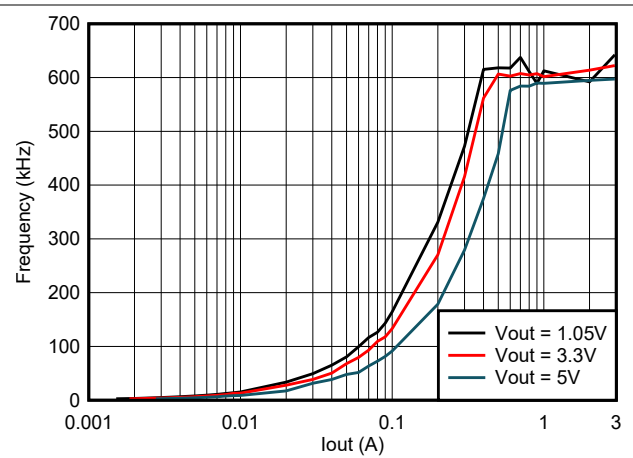

5-8. TPS563203 Frequency vs Loading

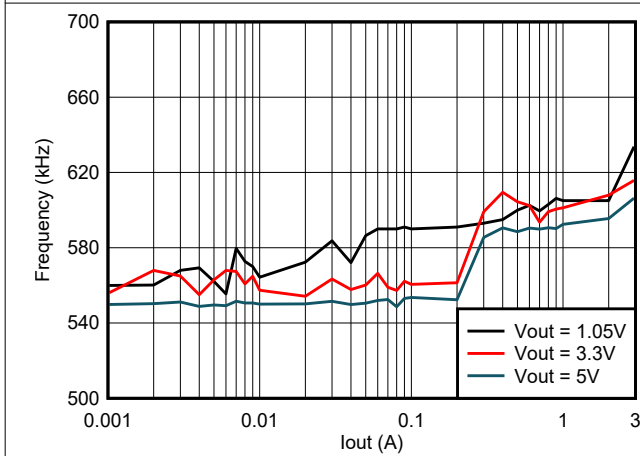

5-9. TPS563206 Frequency vs Loading

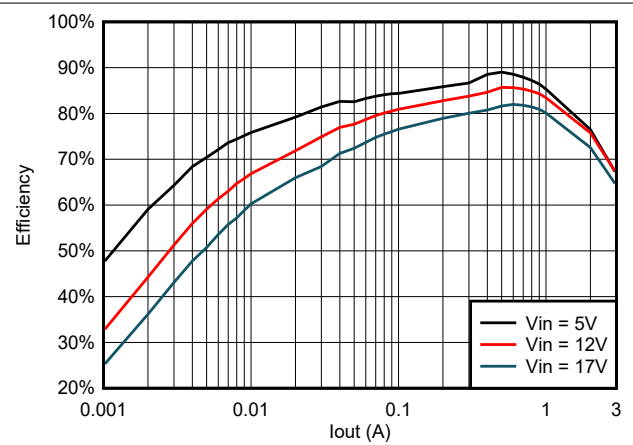

5-10. TPS563203 Efficiency at 0.6 Vout With 1.5uH Inductor

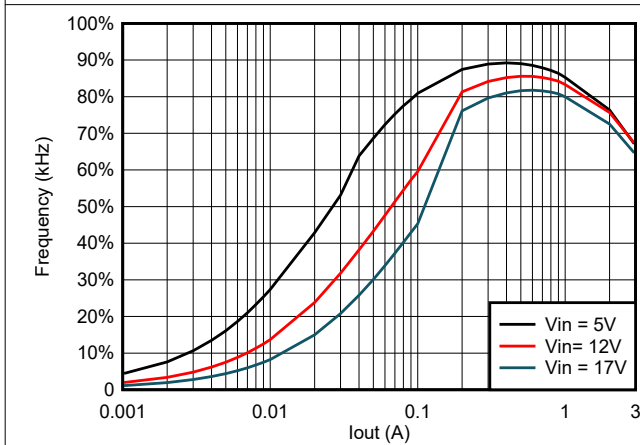

5-11. TPS563206 Efficiency at 0.6 Vout With 1.5uH Inductor

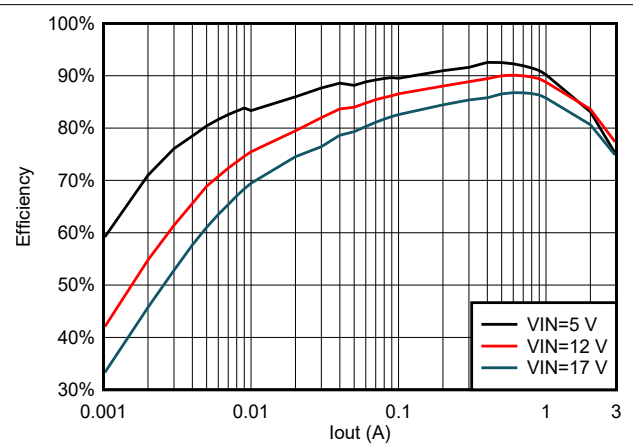

5-12. TPS563203 Efficiency at 1.05 Vout With 2.2uH Inductor



## 5.6 Typical Characteristics (continued)

$V_{IN} = 12\text{ V}$  (unless otherwise noted)

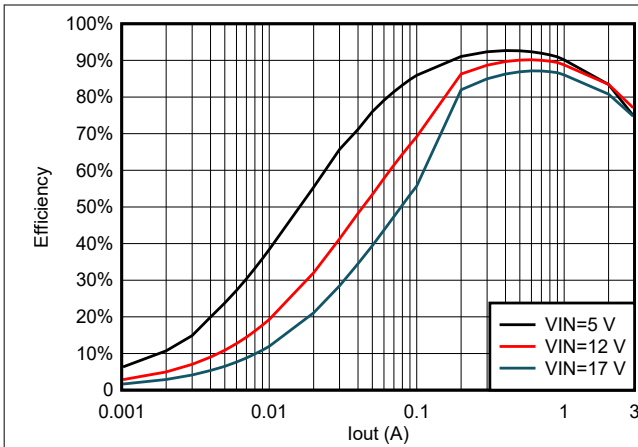

**5-13. TPS563206 Efficiency at 1.05 Vout With 2.2 $\mu$ H Inductor**

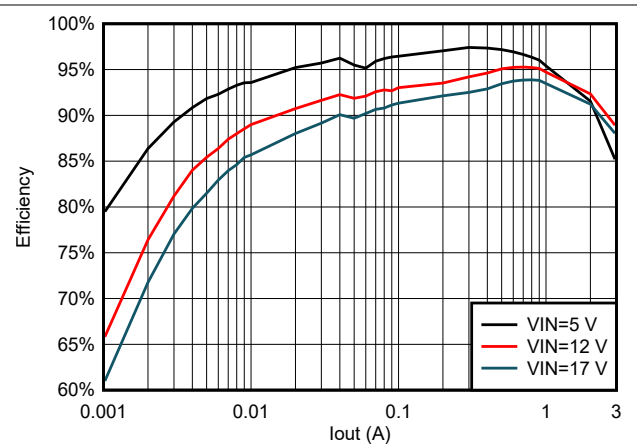

**5-14. TPS563203 Efficiency at 3.3 Vout With 4.7 $\mu$ H Inductor**

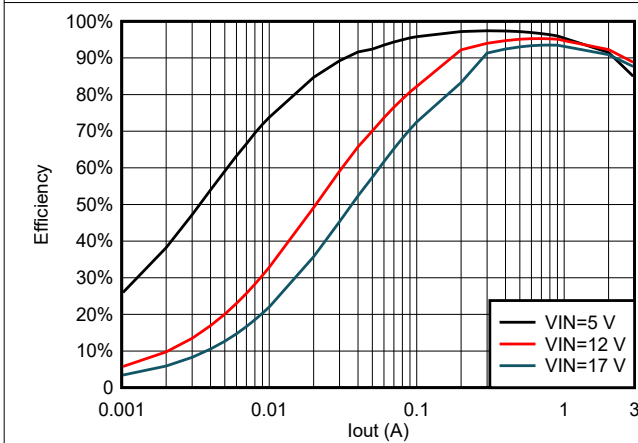

**5-15. TPS563206 Efficiency at 3.3 Vout With 4.7 $\mu$ H Inductor**

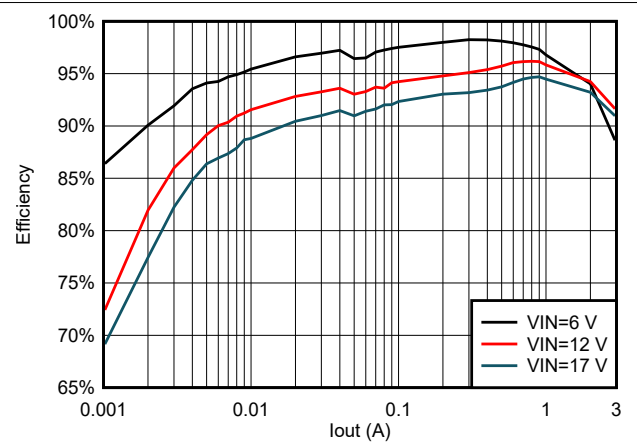

**5-16. TPS563203 Efficiency at 5 Vout With 4.7 $\mu$ H Inductor**

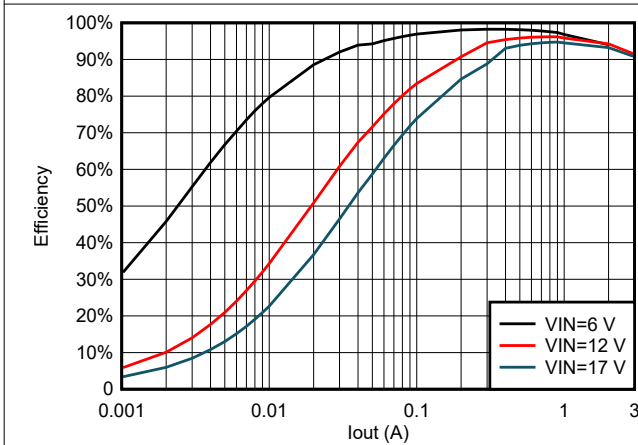

**5-17. TPS563206 Efficiency at 5 Vout With 4.7 $\mu$ H Inductor**

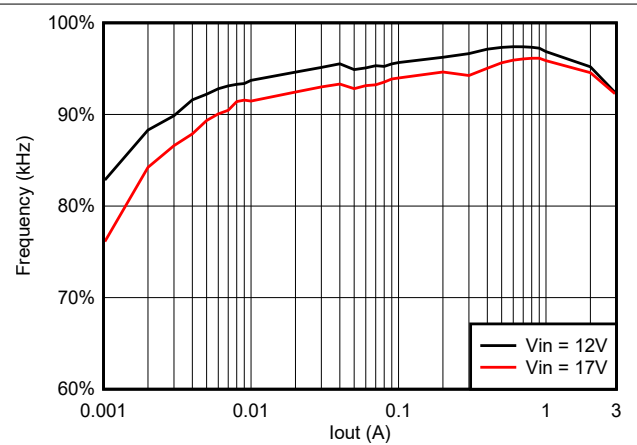

**5-18. TPS563203 Efficiency at 7 Vout With 6.8 $\mu$ H Inductor**

### 5.6 Typical Characteristics (continued)

$V_{IN} = 12\text{ V}$  (unless otherwise noted)



图 5-19. TPS563206 Efficiency at 7 Vout With 6.8uH Inductor

## 6 Detailed Description

### 6.1 Overview

The TPS56320x is a 3A integrated, FET, synchronous step-down buck converter that operates from 4.2V to 17V input voltage (VIN) and 0.6V to 7V output voltage. The device employs D-CAP3 control mode that provides fast transient response with no external compensation components and an accurate feedback voltage. The proprietary D-CAP3 control mode enables low external component count, ease of design, and optimization of the power design for cost, size, and efficiency. The topology provides a seamless transition between CCM operating mode at higher load condition and DCM operation at lighter load condition.

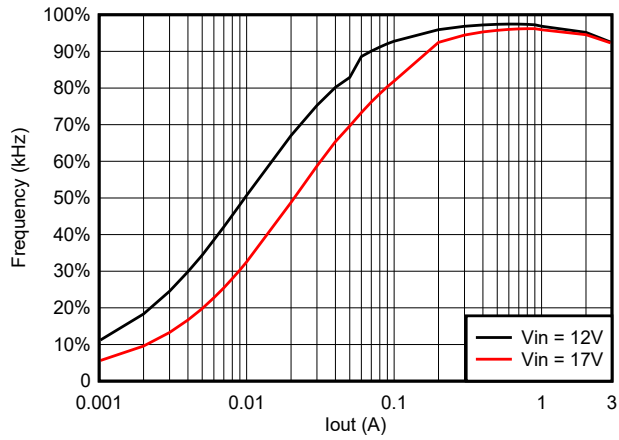
The Eco-mode version allows the TPS563203 to maintain high efficiency at light load. The FCCM mode version allows the TPS563206 to maintain a fixed switching frequency and lower output voltage ripple. The TPS56320x is able to adapt to both low equivalent series resistance (ESR) output capacitors, such as POSCAP or SP-CAP and ultra-low ESR ceramic capacitors.

### 6.2 Functional Block Diagram

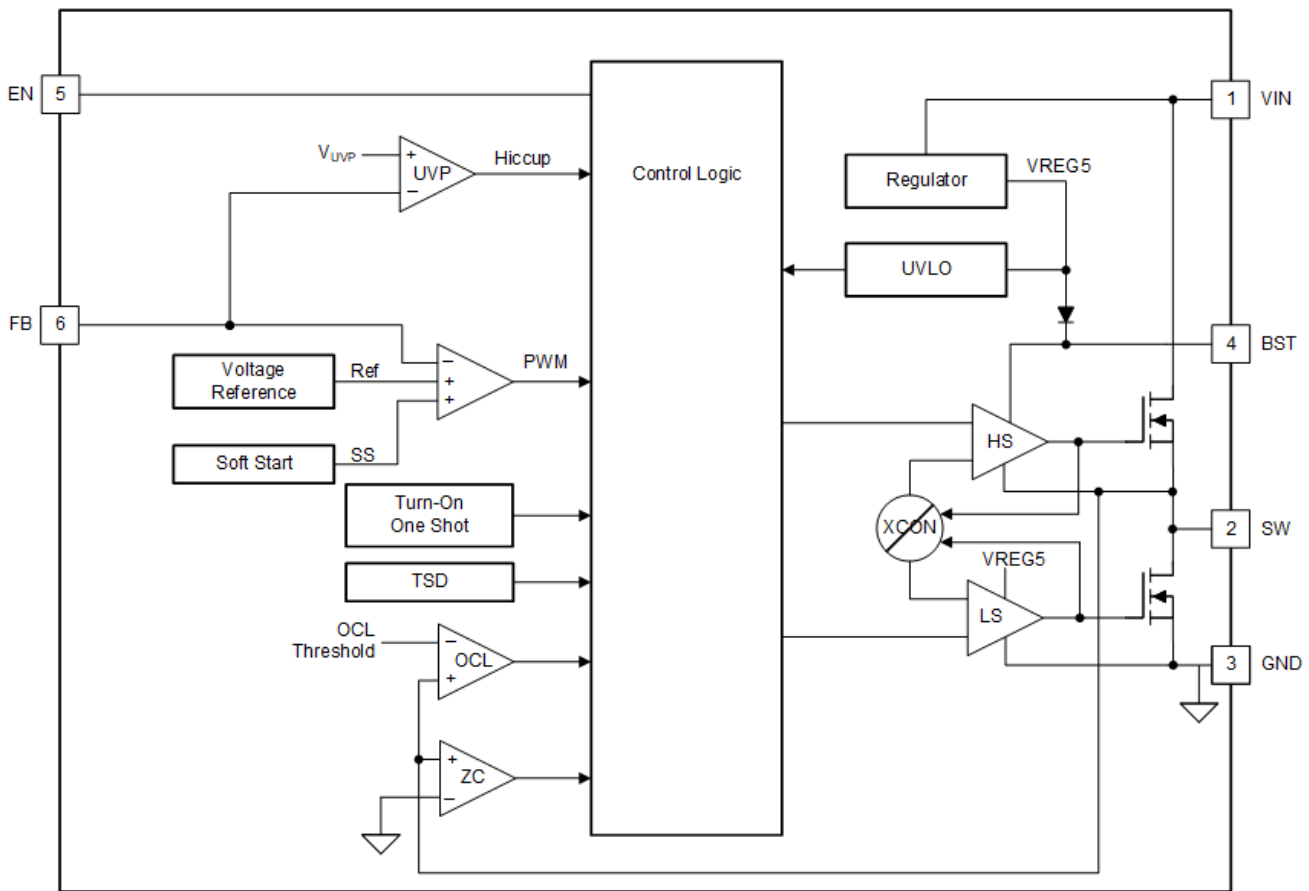

Copyright © 2019, Texas Instruments Incorporated

### 6.3 Feature Description

#### 6.3.1 Adaptive On-Time Control and PWM Operation

The main control loop of the TPS56320x is an adaptive on-time pulse width modulation (PWM) controller that supports a proprietary D-CAP3 control mode. The D-CAP3 control mode combines adaptive on-time control with an internal compensation circuit for pseudo-fixed frequency and low external component count configuration with both low-ESR and ceramic output capacitors. D-CAP3 control mode is stable even with virtually no ripple at the output. The TPS56320x also includes an error amplifier that makes the output voltage very accurate.

At the beginning of each cycle, the high-side MOSFET is turned on. This MOSFET is turned off after internal one shot timer expires. This one shot duration is set proportional to the output voltage,  $V_O$ , and inversely proportional to the converter input voltage,  $V_{IN}$ , to maintain a pseudo-fixed frequency over the input voltage range, hence called adaptive on-time control. The one-shot timer is reset and the high-side MOSFET is turned on again when the feedback voltage falls below the reference voltage. An internal ramp is added to reference voltage to simulate output ripple, eliminating the need for ESR induced output ripple from D-CAP3 control mode.

### 6.3.2 Eco-mode Control

TPS563203 is designed with advanced Eco-mode to maintain high light load efficiency. As the output current decreases from heavy load condition, the inductor current is also reduced and eventually comes to point that its ripple valley touches zero level, which is the boundary between continuous conduction and discontinuous conduction modes. The rectifying MOSFET is turned off when the zero inductor current is detected. As the load current further decreases the converter runs into discontinuous conduction mode. The on-time is kept almost the same as it was in the continuous conduction mode so that it takes longer time to discharge the output capacitor with smaller load current to the level of the reference voltage. This action makes the switching frequency lower, proportional to the load current, and keeps the light load efficiency high. Use 式 1 to calculate the transition point to the light load operation  $I_{OUT(LL)}$  current.

$$I_{out(LL)} = \frac{1}{2 \times L \times f_{SW}} \times \frac{(V_{IN} - V_{OUT}) \times V_{OUT}}{V_{IN}} \quad (1)$$

### 6.3.3 Soft Start and Prebiased Soft Start

TPS56320x have an internal typical 1.4ms soft-start time. When the EN pin becomes high, the internal soft-start function begins ramping up the reference voltage to the PWM comparator.

If the output capacitor is prebiased at start-up, the device initiates switching and start ramping up only after the internal reference voltage becomes greater than the feedback voltage  $V_{FB}$ . This scheme makes sure that the converters ramp up smoothly into regulation point.

### 6.3.4 Large Duty Operation

The TPS56320x can support large duty operations up to 95% by smoothly dropping down the switching frequency. When input voltage  $V_{in} < 7V$  and  $V_{FB}$  is lower than internal reference voltage, the switching frequency is allowed to smoothly drop to make  $T_{ON}$  extended to keep output voltage and improve the load transient performance. The minimum switching frequency is limited to about 200kHz.

### 6.3.5 Current Protection

The output overcurrent limit (OCL) is implemented using a cycle-by-cycle valley detect control circuit. The switch current is monitored during the OFF state by measuring the low-side FET drain to source voltage. This voltage is proportional to the switch current. To improve accuracy, the voltage sensing is temperature compensated.

During the on time of the high-side FET switch, the switch current increases at a linear rate determined by  $V_{in}$ ,  $V_{out}$ , the on-time and the output inductor value. During the on time of the low-side FET switch, this current decreases linearly. The average value of the switch current is the load current  $I_{out}$ . If the monitored current is above the OCL level, the converter maintains low-side FET on and delays the creation of a new set pulse, even the voltage feedback loop requires one, until the current level becomes OCL level or lower. In subsequent switching cycles, the on-time is set to a fixed value and the current is monitored in the same manner.

There are some important considerations for this type of overcurrent protection. The load current is higher than the overcurrent threshold by one half of the peak-to-peak inductor ripple current. Also, when the current is being limited, the output voltage tends to fall as the demanded load current can be higher than the current available from the converter. This action even can cause the output voltage to fall. When the FB voltage falls below the UVP threshold voltage, the UVP comparator detects the fall. And then, the device shuts down after the UVP delay time and re-starts after the hiccup time.

When the overcurrent condition is removed, the output voltage returns to the regulated value.

The TPS563206 is an FCCM mode part. In this mode, the device has negative inductor current at light loading. The device has NOC (negative overcurrent) protection to avoid too large negative current. NOC protection detects the valley of inductor current. When the valley value of inductor current exceeds the NOC threshold, the IC turns off the low side then turns on the high side. When NOC protection is triggered eight times continuously, IC turns off both high side FET and low side FET. When the NOC condition is removed and output voltage returns to target value, the device returns to normal switching.

Because the TPS563206 is an FCCM mode port, if the inductance is so small that the device trigger NOC, this action causes output voltage to be higher than target value. The minimum inductance is identified as 式 2.

$$L = \frac{V_{out} \times \left(1 - \frac{V_{out}}{V_{in}}\right)}{2 \times \text{Frequency} \times \text{NOC}_{min}} \quad (2)$$

### 6.3.6 Enable Circuit

The EN pin controls the turn-on and turn-off of the device. When EN pin voltage is above the turn-on threshold, the device starts switching, and when the EN pin voltage falls below the turn-off threshold, the device stops switching. The default status is low because there is a 1uA pulldown current in internal IC.

EN can be controlled by a typical divider resistor circuit from Vin or by a voltage of lower than 5.5V.

TPS56320x also allows EN to connect to Vin by only a pullup resistor, which is suggested a 100k ohm resistor. EN voltage is clamped by a Zener diode. This Zener diode is not allowed to go through large current. R1 is not allowed smaller than 80k ohm. R1 must also not use a too large resistor to avoid EN not being able to turn on. So R1 range is 80k ohm to 3M ohm. R1 must to use 100k ohm.



図 6-1. EN Block Circuit

### 6.3.7 Undervoltage Lockout (UVLO) Protection

UVLO protection monitors the internal regulator voltage. When the voltage is lower than UVLO threshold voltage, the device is shut off. This protection is non-latching.

### 6.3.8 Thermal Shutdown

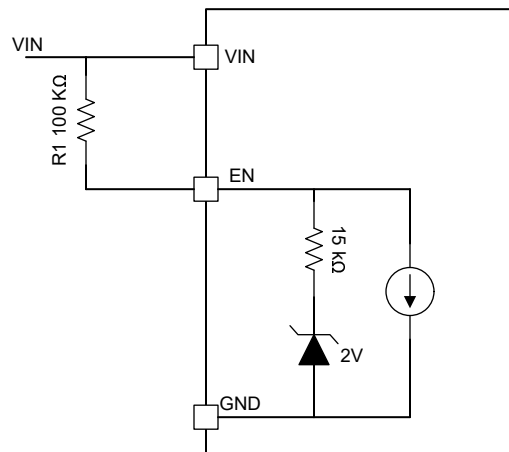
The device monitors the temperature of itself. If the temperature exceeds the threshold value (typically 155°C), the device is shut off. This protection is a non-latch protection.

## 6.4 Device Functional Modes

### 6.4.1 Eco-mode Operation

The TPS563203 operates in Eco-mode, which maintains high efficiency at light loading. As the output current decreases from heavy load conditions, the inductor current is also reduced and eventually comes to a point

where the rippled valley touches zero level, which is the boundary between continuous conduction and discontinuous conduction modes. The rectifying MOSFET is turned off when the zero inductor current is detected. As the load current further decreases, the converter runs into discontinuous conduction mode. The on-time is kept almost the same as the on-time was in continuous conduction mode so that discharging the output capacitor with smaller load current to the level of the reference voltage takes longer. This fact makes the switching frequency lower, proportional to the load current, and keeps the light load efficiency high.

#### 6.4.2 FCCM Mode Operation

The TPS563206 operates in forced CCM (FCCM) mode, which keeps the converter operating in continuous current mode during light load conditions and allows the inductor current to become negative. During FCCM mode, the switching frequency (FSW) is maintained at an almost constant level over the entire load range, which is designed for applications requiring tight control of the switching frequency and output voltage ripple at the cost of lower efficiency under light load.

## 7 Application and Implementation

### 注

Information in the following applications sections is not part of the TI component specification, and TI does not warrant its accuracy or completeness. TI's customers are responsible for determining suitability of components for their purposes, as well as validating and testing their design implementation to confirm system functionality.

### 7.1 Application Information

The devices are typical buck DC/DC converters. The devices are typically used to convert a higher DC voltage to a lower DC voltage with a maximum available output current of 3A. The following design procedure can be used to select component values for TPS56320x. Alternately, use the WEBENCH® software to generate a complete design. The WEBENCH software uses an iterative design procedure and accesses a comprehensive database of components when generating a design. This section presents a simplified discussion of the design process.

### 7.2 Typical Application

The application schematic in [Figure 7-1](#) is developed to meet the previous requirements. This circuit is available as the evaluation module (EVM). The section provide the design procedure.

[Figure 7-1](#) shows the TPS563203 4.2V to 17V input, 1.05V output converter schematics.

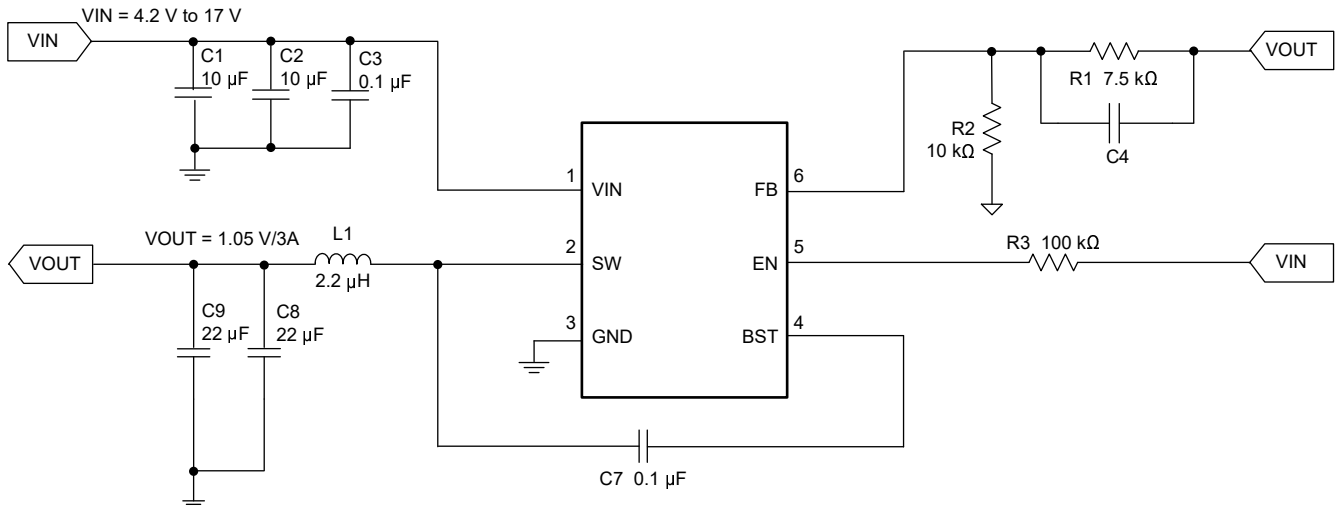

**Figure 7-1. TPS563203 1.05V/3A Reference Design**

## 7.2.1 Design Requirements

表 7-1 shows the design parameters for this application.

**表 7-1. Design Parameters**

PARAMETER	EXAMPLE VALUE
Input voltage range	4.2V to 17V
Output voltage	1.05V
Transient response, 1.5A load step	$\Delta V_{out} = \pm 5\%$
Input ripple voltage	100mV
Output ripple voltage	20mV
Output current rating	3A
Operating frequency	600kHz

## 7.2.2 Detailed Design Procedure

### 7.2.2.1 Custom Design with WEBENCH® Tools

[Click here](#) to create a custom design using the TPS563203 device with the WEBENCH® Power Designer.

[Click here](#) to create a custom design using the TPS563206 device with the WEBENCH® Power Designer.

1. Start by entering the input voltage ( $V_{IN}$ ), output voltage ( $V_{OUT}$ ), and output current ( $I_{OUT}$ ) requirements.
2. Optimize the design for key parameters such as efficiency, footprint, and cost using the optimizer dial.
3. Compare the generated design with other possible solutions from Texas Instruments.

The WEBENCH Power Designer provides a customized schematic along with a list of materials with real-time pricing and component availability.

In most cases, these actions are available:

- Run electrical simulations to see important waveforms and circuit performance
- Run thermal simulations to understand board thermal performance
- Export customized schematic and layout into popular CAD formats
- Print PDF reports for the design, and share the design with colleagues

Get more information about WEBENCH tools at [www.ti.com/WEBENCH](http://www.ti.com/WEBENCH).

### 7.2.2.2 Output Voltage Resistors Selection

The output voltage is set with a resistor divider from the output node to the FB pin. TI recommends to use 1% tolerance or better divider resistors. Start by using 式 3 to calculate  $V_{OUT}$ .

To improve efficiency at very light loads, consider using larger value resistors. Too high of resistance is more susceptible to noise and voltage errors from the FB input current are more noticeable.

$$V_{OUT} = 0.6 \times \left( 1 + \frac{R1}{R2} \right) \quad (3)$$

### 7.2.2.3 Output Filter Selection

The LC filter used as the output filter has a double pole at 式 4. In this equation,  $C_{OUT}$  must use the effective value after derating, not the nominal value.

$$Frequency_{doublepole} = \frac{1}{2 \times \pi \times \sqrt{L_{OUT} \times C_{OUT}}} \quad (4)$$

For any control topology that is compensated internally, there is a range of the output filter the control topology can support. At low frequency, the overall loop gain is set by the output set-point resistor divider network and the internal gain of the device. The low frequency phase is 180°. At the output filter pole frequency, the gain rolls off



at a –40dB per decade rate and the phase drops has a 180 degree drop. The internal ripple generation network introduces a high-frequency zero that reduces the gain roll off from –40dB to –20dB per decade and leads the 90 degree phase boost. The internal ripple injection high-frequency zero is about 41kHz. TI recommends the inductor and capacitor selected for the output filter that the double pole is located about 20kHz, so that the phase boost provided by this high-frequency zero provides adequate phase margin for the stability requirement. For higher than 2V output voltage, TI suggests to add a CFF (Cap of Feed Forward) C4 in schematic to increase the bandwidth and phase margin. The suggested CFF range is 10pF to 100pF. The crossover frequency of the overall system must usually be targeted to be less than one-third of the switching frequency.

**表 7-2. Recommended Component Values**

OUTPUT VOLTAGE (V)	R1 (kΩ)	R2 (kΩ)	Min L(uH)	TYP L (uH)	Max L(uH)	Min Cout(uF)	Typ Cout(uF)	Max Cout(uF)	Typ CFF(pF)
0.8	3.33	10.0	1.2	1.5	3.3	22	66	110	-
1.05	7.5	10.0	1.2	2.2	3.3	22	44	110	-
2.5	95.0	30.0	2.2	3.3	4.7	22	44	110	10
3.3	135.0	30.0	3.3	4.7	6.8	22	44	110	18
5	220.0	30.0	3.3	4.7	6.8	22	44	110	18
7	320.0	30.0	3.3	4.7	6.8	22	44	110	18

Use 式 5, 式 6, and 式 7 to calculate the inductor peak-to-peak ripple current, peak current and RMS current. The inductor saturation current rating must be greater than the calculated peak current and the RMS or heating current rating must be greater than the calculated RMS current.

$$I_{P-P} = \frac{V_{OUT}}{V_{IN(Max)}} \times \frac{V_{IN(Max)} - V_{OUT}}{L_{OUT} \times f_{SW}} \quad (5)$$

$$I_{PEAK} = I_O + \frac{I_{P-P}}{2} \quad (6)$$

$$I_{LO(RMS)} = \sqrt{I_O^2 + \frac{1}{12} \times I_{P-P}^2} \quad (7)$$

For this design example, the calculated peak current is 3.68A and the calculated RMS current is 3.03A. The inductor used is a WE 74437349022.

The capacitor value and ESR determines the amount of output voltage ripple. The TPS563203 are intended for use with ceramic or other low ESR capacitors. TI recommends to use 2 × 22μF output cap. Use 式 8 to determine the required RMS current rating for the output capacitor.

$$I_{CO(RMS)} = \frac{V_{OUT} \times (V_{IN} - V_{OUT})}{\sqrt{12} \times V_{IN} \times L_{OUT} \times f_{SW}} \quad (8)$$

For this design, two MuRata GRM21BR61A226ME44L 22μF output capacitors are used. The typical ESR is 2mΩ each. The calculated RMS current is 0.286A and each output capacitor is rated for 4A.

#### 7.2.2.4 Input Capacitor Selection

The TPS563203 requires an input decoupling capacitor, and a bulk capacitor is needed depending on the application. TI recommends a ceramic capacitor over 10μF for the decoupling capacitor. An additional 0.1μF capacitor (C3) from pin 3 to ground is optional to provide additional high frequency filtering. The capacitor voltage rating must be greater than the maximum input voltage.

#### 7.2.2.5 Bootstrap Capacitor Selection

Connect a 0.1μF ceramic capacitor between the BST to SW pin for proper operation. TI recommends to use a ceramic capacitor.

### 7.2.3 Application Curves

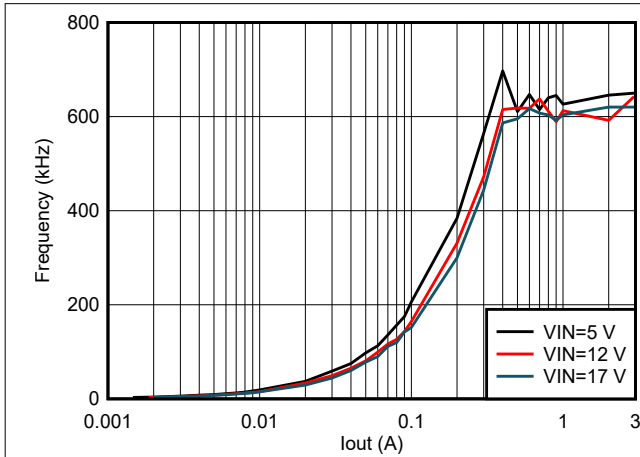

**7-2. TPS563203 Frequency vs Loading**

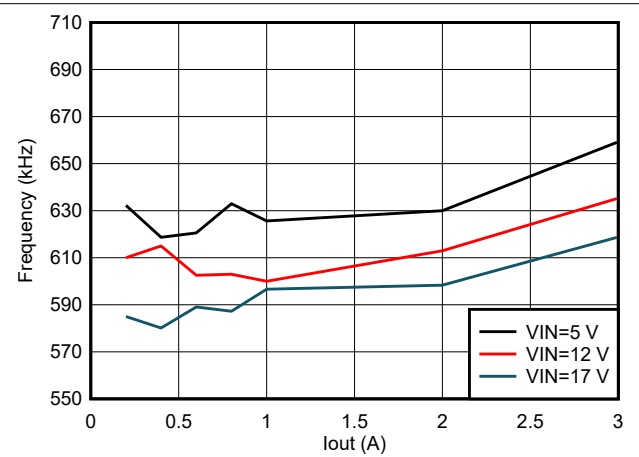

**7-3. TPS563206 Frequency vs Loading**

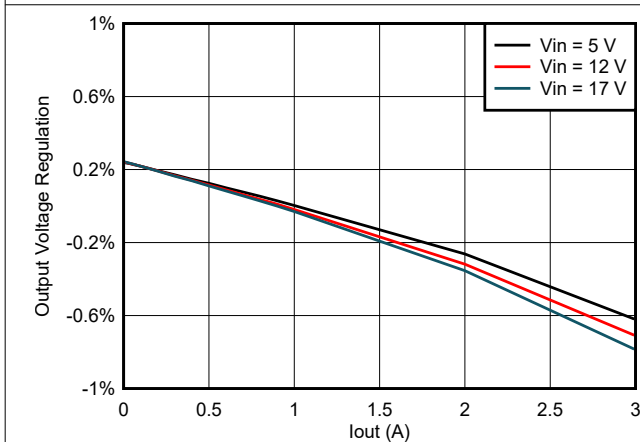

**7-4. TPS563203 Load Regulation vs Loading**

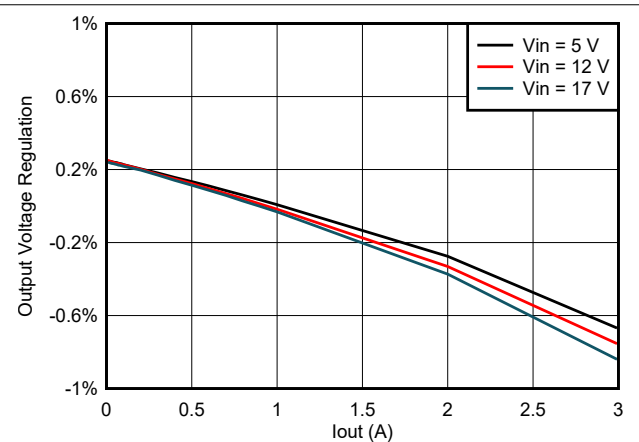

**7-5. TPS563206 Load Regulation vs Loading**

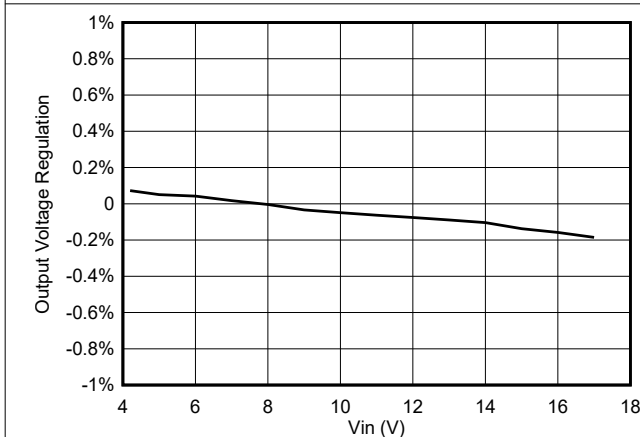

**7-6. TPS563203 Line Regulation vs Vin at 1-A Loading**

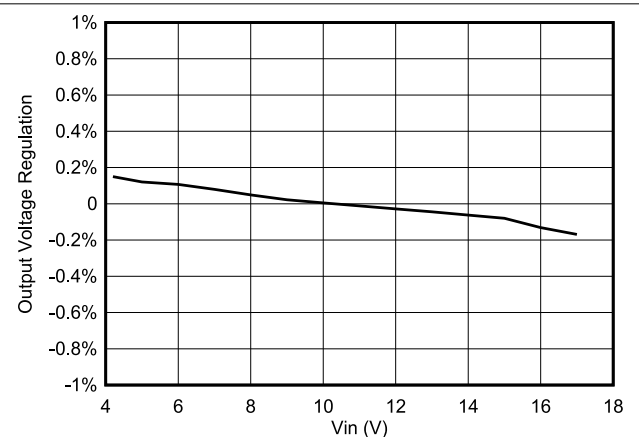

**7-7. TPS563206 Line Regulation vs Vin at 1-A Loading**

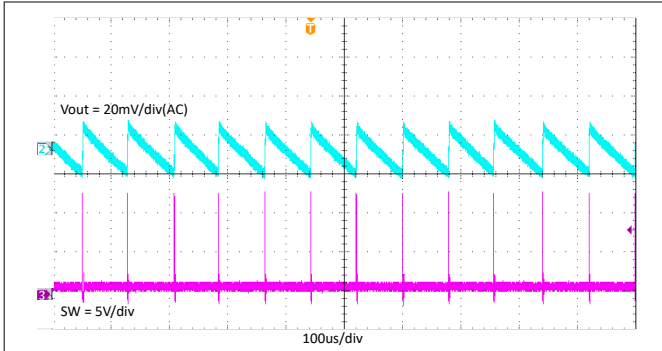

**7-8. TPS563203 Output Voltage Ripple With 0.1A Loading**

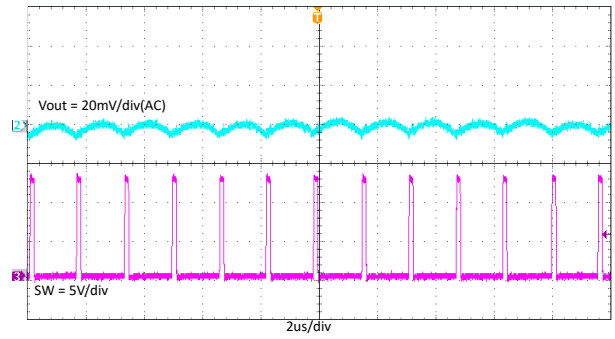

**7-9. TPS563206 Output Voltage Ripple With 0.1A Loading**

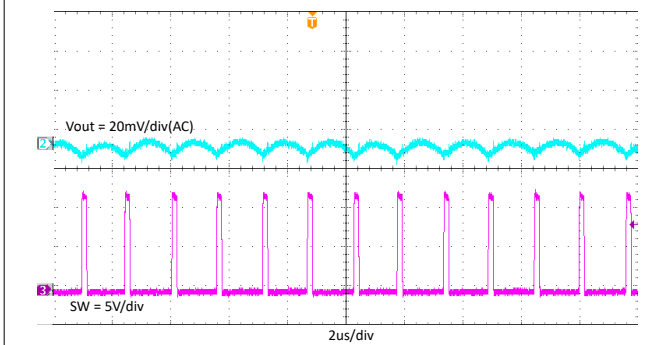

**7-10. TPS563203 Output Voltage Ripple With 3A Loading**

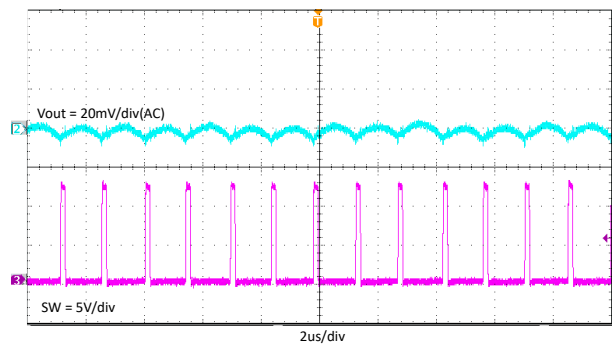

**7-11. TPS563206 Output Voltage Ripple With 3A Loading**

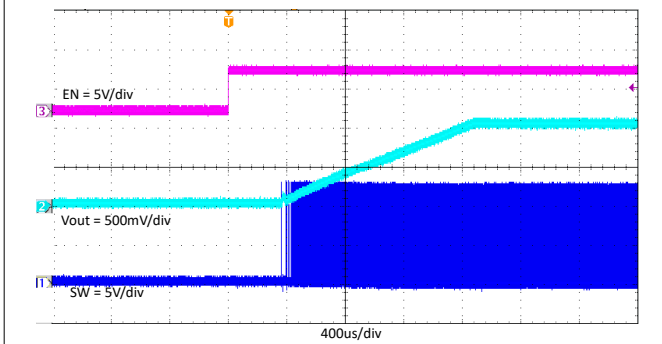

**7-12. TPS563203 Enable on With 3A Loading**

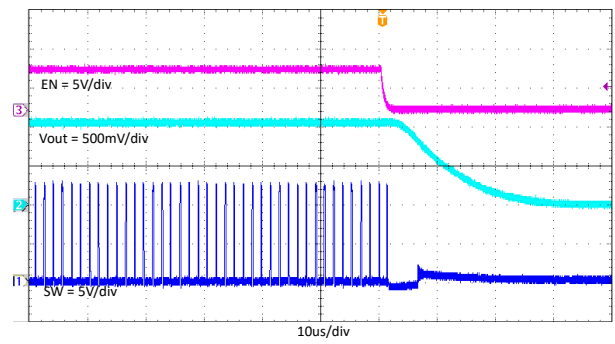

**7-13. TPS563203 Enable off With 3A Loading**

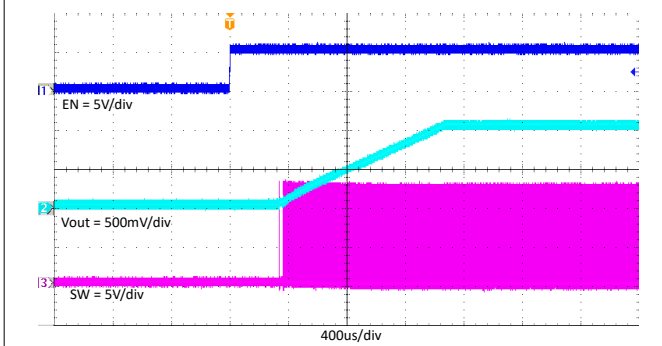

**7-14. TPS563206 Enable on With 3A Loading**

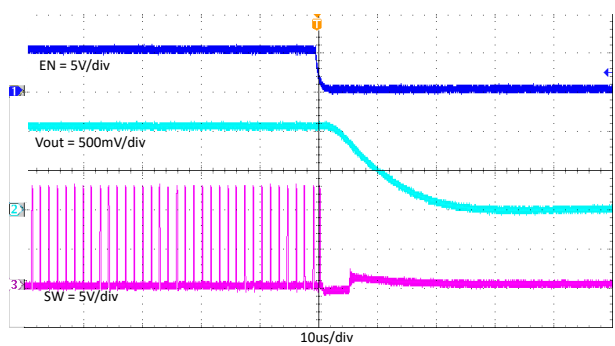

**7-15. TPS563206 Enable off With 3A Loading**

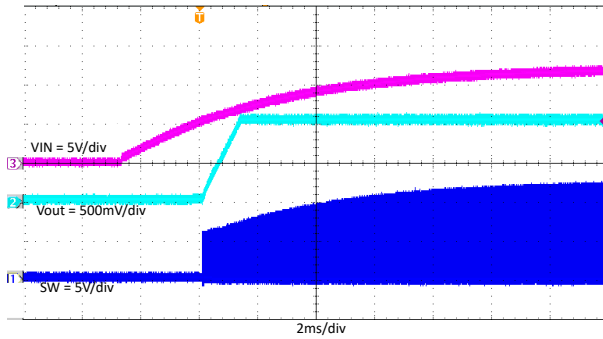

**7-16. TPS563203 Power on With 3A Loading**

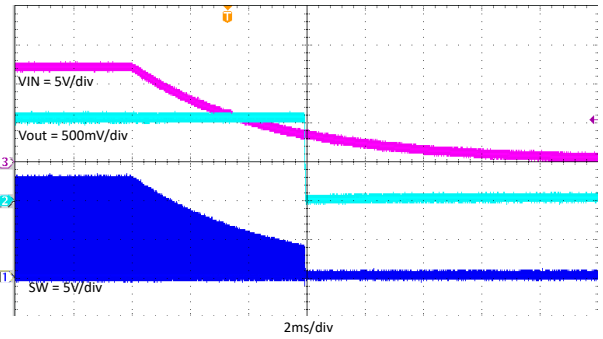

**7-17. TPS563203 Power off With 3A Loading**

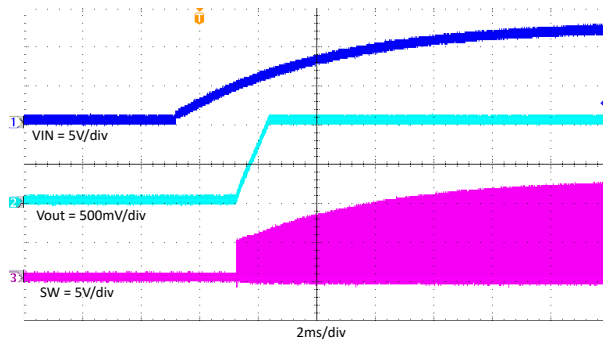

**7-18. TPS563206 Power on With 3A Loading**

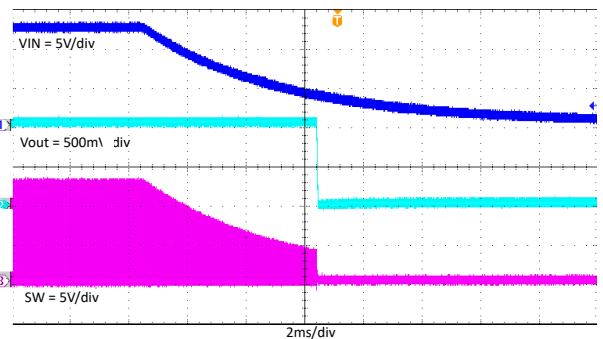

**7-19. TPS563206 Power off With 3A Loading**

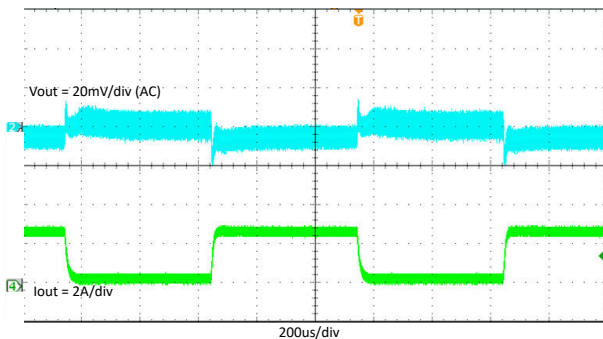

**7-20. TPS563203 Load Transient With 0.3A to 2.7A**

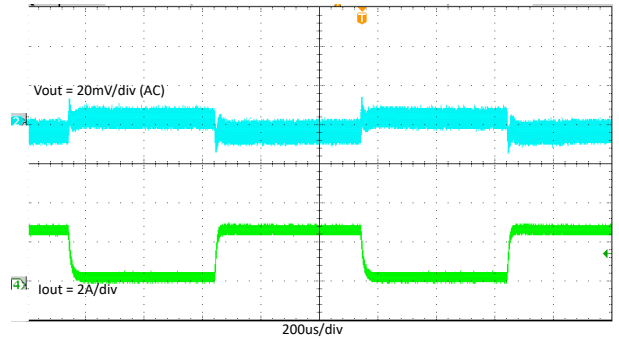

**7-21. TPS563206 Load Transient With 0.3A to 2.7A**

## 7.3 Power Supply Recommendations

TPS56320x are designed to operate from input supply voltages in the range of 4.2V to 17V. Buck converters require the input voltage to be higher than the output voltage for proper operation. The maximum duty is 95%.

## 7.4 Layout

### 7.4.1 Layout Guidelines

1. Make VIN and GND traces as wide as possible to reduce trace impedance. The wide areas are also of advantage from the view point of heat dissipation.
2. Place the input capacitor and output capacitor as close to the device as possible to minimize trace impedance.
3. Provide sufficient vias for the input capacitor and output capacitor.
4. Keep the SW trace as physically short and wide as practical to minimize radiated emissions.
5. Do not allow switching current to flow under the device.
6. Connect a separate VOUT path to the upper feedback resistor.

7. Make a Kelvin connection to the GND pin for the feedback path.
8. Place voltage feedback loop away from the high-voltage switching trace, and preferably make sure there is ground shield.
9. Make the trace of the FB node as small as possible to avoid noise coupling.
10. Make the GND trace between the output capacitor and the GND pin as wide as possible to minimize the trace impedance.

### 7.4.2 Layout Example

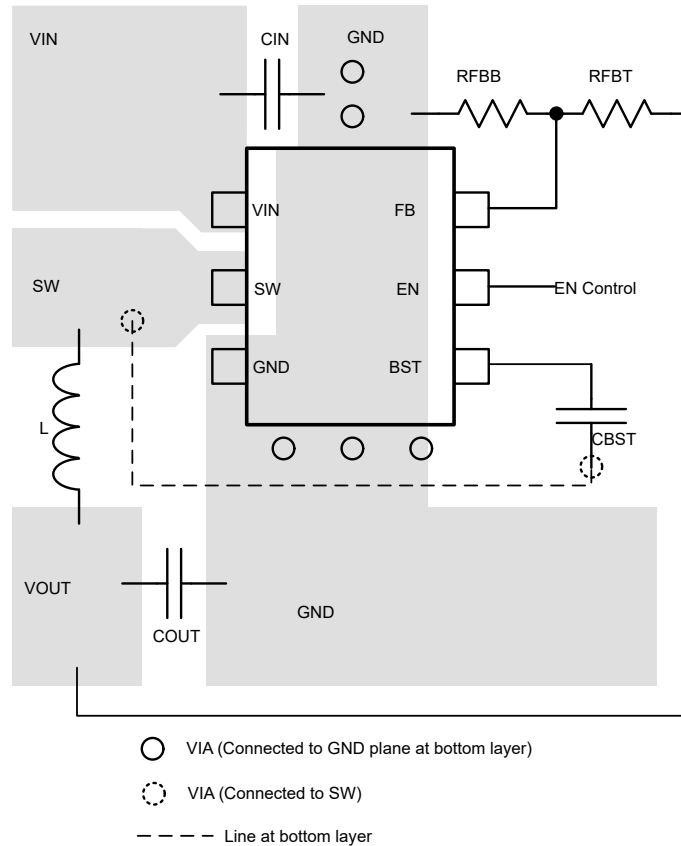

**7-22. TPS563203 Layout**

## 8 Device and Documentation Support

### 8.1 Device Support

#### 8.1.1 Development Support

##### 8.1.1.1 Custom Design with WEBENCH® Tools

[Click here](#) to create a custom design using the TPS563203 device with the WEBENCH® Power Designer.

[Click here](#) to create a custom design using the TPS563206 device with the WEBENCH® Power Designer.

1. Start by entering the input voltage ( $V_{IN}$ ), output voltage ( $V_{OUT}$ ), and output current ( $I_{OUT}$ ) requirements.
2. Optimize the design for key parameters such as efficiency, footprint, and cost using the optimizer dial.
3. Compare the generated design with other possible solutions from Texas Instruments.

The WEBENCH Power Designer provides a customized schematic along with a list of materials with real-time pricing and component availability.

In most cases, these actions are available:

- Run electrical simulations to see important waveforms and circuit performance
- Run thermal simulations to understand board thermal performance
- Export customized schematic and layout into popular CAD formats
- Print PDF reports for the design, and share the design with colleagues

Get more information about WEBENCH tools at [www.ti.com/WEBENCH](http://www.ti.com/WEBENCH).

### 8.2 ドキュメントの更新通知を受け取る方法

ドキュメントの更新についての通知を受け取るには、[www.tij.co.jp](http://www.tij.co.jp) のデバイス製品フォルダを開いてください。[通知] をクリックして登録すると、変更されたすべての製品情報に関するダイジェストを毎週受け取ることができます。変更の詳細については、改訂されたドキュメントに含まれている改訂履歴をご覧ください。

### 8.3 サポート・リソース

テキサス・インスツルメンツ E2E™ サポート・フォーラムは、エンジニアが検証済みの回答と設計に関するヒントをエキスパートから迅速かつ直接得ることができる場所です。既存の回答を検索したり、独自の質問をしたりすることで、設計に必要な支援を迅速に得ることができます。

リンクされているコンテンツは、各寄稿者により「現状のまま」提供されるものです。これらはテキサス・インスツルメンツの仕様を構成するものではなく、必ずしもテキサス・インスツルメンツの見解を反映したものではありません。テキサス・インスツルメンツの[使用条件](#)を参照してください。

### 8.4 Trademarks

D-CAP3™ and テキサス・インスツルメンツ E2E™ are trademarks of Texas Instruments.

WEBENCH® is a registered trademark of Texas Instruments.

すべての商標は、それぞれの所有者に帰属します。

### 8.5 静電気放電に関する注意事項



この IC は、ESD によって破損する可能性があります。テキサス・インスツルメンツは、IC を取り扱う際には常に適切な注意を払うことを推奨します。正しい取り扱いおよび設置手順に従わない場合、デバイスを破損するおそれがあります。

ESD による破損は、わずかな性能低下からデバイスの完全な故障まで多岐にわたります。精密な IC の場合、パラメータがわずかに変化するだけで公表されている仕様から外れる可能性があるため、破損が発生しやすくなっています。

### 8.6 用語集

[テキサス・インスツルメンツ用語集](#)

この用語集には、用語や略語の一覧および定義が記載されています。

## 9 Revision History

### Changes from Revision \* (March 2023) to Revision A (January 2024)

Page

- 
- ドキュメントのステータスを「事前情報」から「量産データ」に変更..... 1
- 

## 10 Mechanical, Packaging, and Orderable Information

The following pages include mechanical, packaging, and orderable information. This information is the most current data available for the designated devices. This data is subject to change without notice and revision of this document. For browser-based versions of this data sheet, refer to the left-hand navigation.

## 重要なお知らせと免責事項

テキサス・インスツルメンツは、技術データと信頼性データ(データシートを含みます)、設計リソース(リファレンス デザインを含みます)、アプリケーションや設計に関する各種アドバイス、Web ツール、安全性情報、その他のリソースを、欠陥が存在する可能性のある「現状のまま」提供しており、商品性および特定目的に対する適合性の黙示保証、第三者の知的財産権の非侵害保証を含むいかなる保証も、明示的または黙示的にかかわらず拒否します。

これらのリソースは、テキサス・インスツルメンツ製品を使用する設計の経験を積んだ開発者への提供を意図したものです。(1) お客様のアプリケーションに適したテキサス・インスツルメンツ製品の選定、(2) お客様のアプリケーションの設計、検証、試験、(3) お客様のアプリケーションに該当する各種規格や、その他のあらゆる安全性、セキュリティ、規制、または他の要件への確実な適合に関する責任を、お客様のみが単独で負うものとします。

上記の各種リソースは、予告なく変更される可能性があります。これらのリソースは、リソースで説明されているテキサス・インスツルメンツ製品を使用するアプリケーションの開発の目的でのみ、テキサス・インスツルメンツはその使用をお客様に許諾します。これらのリソースに関して、他の目的で複製することや掲載することは禁止されています。テキサス・インスツルメンツや第三者の知的財産権のライセンスが付与されている訳ではありません。お客様は、これらのリソースを自身で使用した結果発生するあらゆる申し立て、損害、費用、損失、責任について、テキサス・インスツルメンツおよびその代理人を完全に補償するものとし、テキサス・インスツルメンツは一切の責任を拒否します。

テキサス・インスツルメンツの製品は、[テキサス・インスツルメンツの販売条件](#)、または [ti.com](https://www.ti.com) やかかるテキサス・インスツルメンツ製品の関連資料などのいずれかを通じて提供する適用可能な条項の下で提供されています。テキサス・インスツルメンツがこれらのリソースを提供することは、適用されるテキサス・インスツルメンツの保証または他の保証の放棄の拡大や変更を意味するものではありません。

お客様がいかなる追加条項または代替条項を提案した場合でも、テキサス・インスツルメンツはそれらに異議を唱え、拒否します。

郵送先住所: Texas Instruments, Post Office Box 655303, Dallas, Texas 75265  
Copyright © 2024, Texas Instruments Incorporated



**PACKAGING INFORMATION**

Orderable Device	Status (1)	Package Type	Package Drawing	Pins	Package Qty	Eco Plan (2)	Lead finish/ Ball material (6)	MSL Peak Temp (3)	Op Temp (°C)	Device Marking (4/5)	Samples
TPS563203DRLR	ACTIVE	SOT-5X3	DRL	6	4000	RoHS & Green	Call TI   SN	Level-1-260C-UNLIM	-40 to 125	T203	<a href="#">Samples</a>
TPS563206DRLR	ACTIVE	SOT-5X3	DRL	6	4000	RoHS & Green	Call TI   SN	Level-1-260C-UNLIM	-40 to 125	T206	<a href="#">Samples</a>

(1) The marketing status values are defined as follows:

**ACTIVE:** Product device recommended for new designs.

**LIFEBUY:** TI has announced that the device will be discontinued, and a lifetime-buy period is in effect.

**NRND:** Not recommended for new designs. Device is in production to support existing customers, but TI does not recommend using this part in a new design.

**PREVIEW:** Device has been announced but is not in production. Samples may or may not be available.

**OBSOLETE:** TI has discontinued the production of the device.

(2) **RoHS:** TI defines "RoHS" to mean semiconductor products that are compliant with the current EU RoHS requirements for all 10 RoHS substances, including the requirement that RoHS substance do not exceed 0.1% by weight in homogeneous materials. Where designed to be soldered at high temperatures, "RoHS" products are suitable for use in specified lead-free processes. TI may reference these types of products as "Pb-Free".

**RoHS Exempt:** TI defines "RoHS Exempt" to mean products that contain lead but are compliant with EU RoHS pursuant to a specific EU RoHS exemption.

**Green:** TI defines "Green" to mean the content of Chlorine (Cl) and Bromine (Br) based flame retardants meet JS709B low halogen requirements of <=1000ppm threshold. Antimony trioxide based flame retardants must also meet the <=1000ppm threshold requirement.

(3) MSL, Peak Temp. - The Moisture Sensitivity Level rating according to the JEDEC industry standard classifications, and peak solder temperature.

(4) There may be additional marking, which relates to the logo, the lot trace code information, or the environmental category on the device.

(5) Multiple Device Markings will be inside parentheses. Only one Device Marking contained in parentheses and separated by a "~" will appear on a device. If a line is indented then it is a continuation of the previous line and the two combined represent the entire Device Marking for that device.

(6) Lead finish/Ball material - Orderable Devices may have multiple material finish options. Finish options are separated by a vertical ruled line. Lead finish/Ball material values may wrap to two lines if the finish value exceeds the maximum column width.

**Important Information and Disclaimer:**The information provided on this page represents TI's knowledge and belief as of the date that it is provided. TI bases its knowledge and belief on information provided by third parties, and makes no representation or warranty as to the accuracy of such information. Efforts are underway to better integrate information from third parties. TI has taken and continues to take reasonable steps to provide representative and accurate information but may not have conducted destructive testing or chemical analysis on incoming materials and chemicals. TI and TI suppliers consider certain information to be proprietary, and thus CAS numbers and other limited information may not be available for release.

In no event shall TI's liability arising out of such information exceed the total purchase price of the TI part(s) at issue in this document sold by TI to Customer on an annual basis.



# DRL0006A



# PACKAGE OUTLINE

## SOT - 0.6 mm max height

PLASTIC SMALL OUTLINE

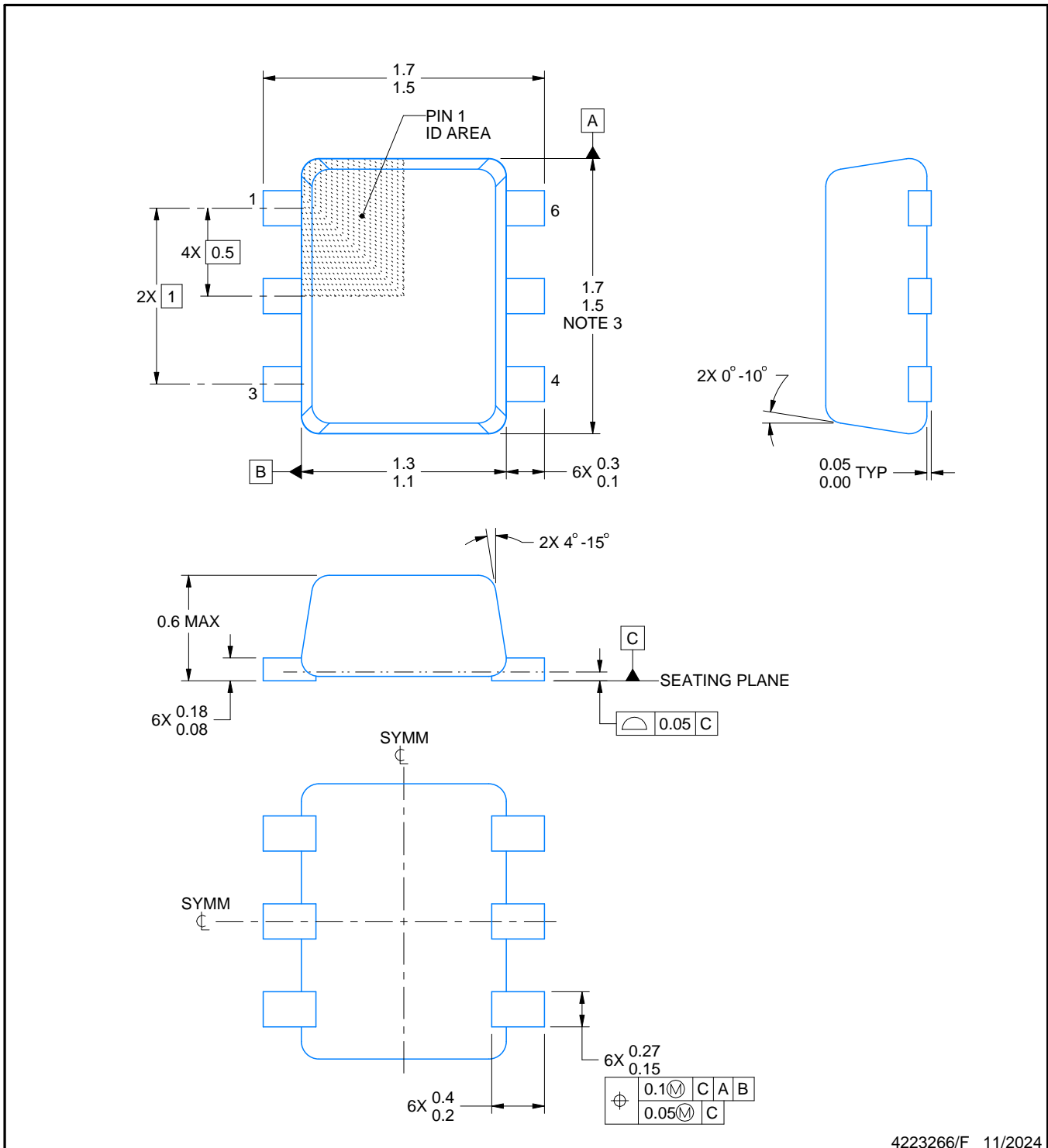

4223266/F 11/2024

### NOTES:

1. All linear dimensions are in millimeters. Any dimensions in parenthesis are for reference only. Dimensioning and tolerancing per ASME Y14.5M.
2. This drawing is subject to change without notice.
3. This dimension does not include mold flash, protrusions, or gate burrs. Mold flash, protrusions, or gate burrs shall not exceed 0.15 mm per side.
4. Reference JEDEC registration MO-293 Variation UAAD

# EXAMPLE BOARD LAYOUT

DRL0006A

SOT - 0.6 mm max height

PLASTIC SMALL OUTLINE

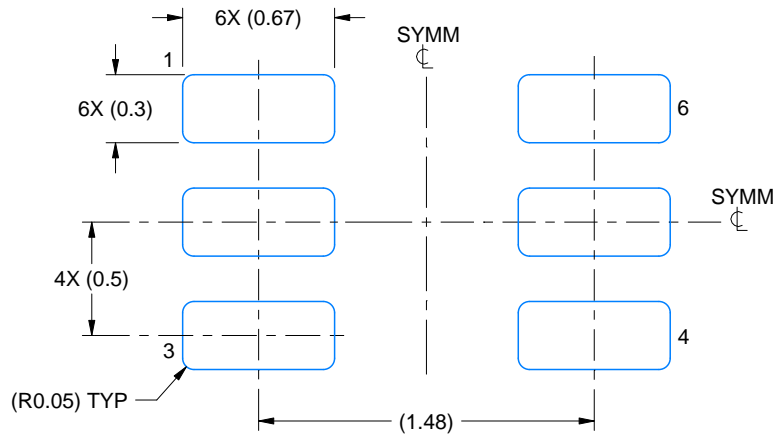

LAND PATTERN EXAMPLE  
SCALE:30X

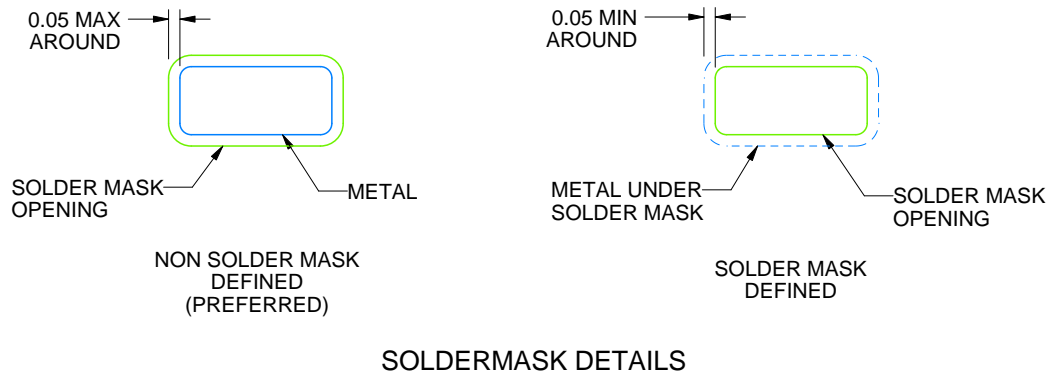

SOLDERMASK DETAILS

4223266/F 11/2024

NOTES: (continued)

5. Publication IPC-7351 may have alternate designs.
6. Solder mask tolerances between and around signal pads can vary based on board fabrication site.
7. Land pattern design aligns to IPC-610, Bottom Termination Component (BTC) solder joint inspection criteria.

# EXAMPLE STENCIL DESIGN

DRL0006A

SOT - 0.6 mm max height

PLASTIC SMALL OUTLINE

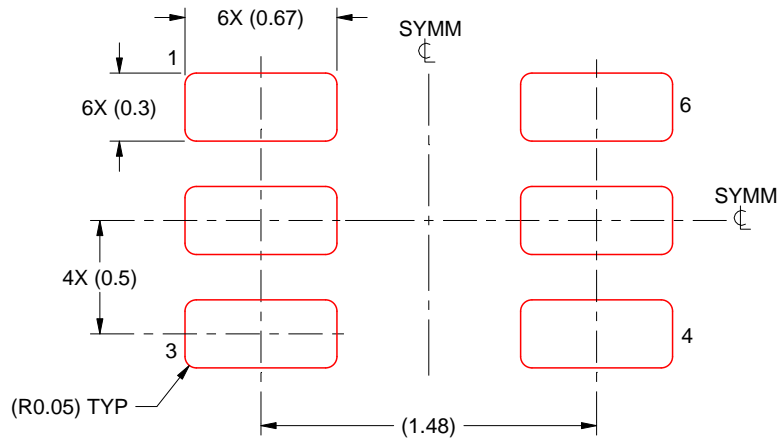

SOLDER PASTE EXAMPLE  
BASED ON 0.1 mm THICK STENCIL  
SCALE:30X

4223266/F 11/2024

NOTES: (continued)

8. Laser cutting apertures with trapezoidal walls and rounded corners may offer better paste release. IPC-7525 may have alternate design recommendations.
9. Board assembly site may have different recommendations for stencil design.

## 重要なお知らせと免責事項

テキサス・インスツルメンツは、技術データと信頼性データ(データシートを含みます)、設計リソース(リファレンス デザインを含みます)、アプリケーションや設計に関する各種アドバイス、Web ツール、安全性情報、その他のリソースを、欠陥が存在する可能性のある「現状のまま」提供しており、商品性および特定目的に対する適合性の黙示保証、第三者の知的財産権の非侵害保証を含むいかなる保証も、明示的または黙示的にかかわらず拒否します。

これらのリソースは、テキサス・インスツルメンツ製品を使用する設計の経験を積んだ開発者への提供を意図したものです。(1) お客様のアプリケーションに適したテキサス・インスツルメンツ製品の選定、(2) お客様のアプリケーションの設計、検証、試験、(3) お客様のアプリケーションに該当する各種規格や、その他のあらゆる安全性、セキュリティ、規制、または他の要件への確実な適合に関する責任を、お客様のみが単独で負うものとし、ます。

上記の各種リソースは、予告なく変更される可能性があります。これらのリソースは、リソースで説明されているテキサス・インスツルメンツ製品を使用するアプリケーションの開発の目的でのみ、テキサス・インスツルメンツはその使用をお客様に許諾します。これらのリソースに関して、他の目的で複製することや掲載することは禁止されています。テキサス・インスツルメンツや第三者の知的財産権のライセンスが付与されている訳ではありません。お客様は、これらのリソースを自身で使用した結果発生するあらゆる申し立て、損害、費用、損失、責任について、テキサス・インスツルメンツおよびその代理人を完全に補償するものとし、テキサス・インスツルメンツは一切の責任を拒否します。

テキサス・インスツルメンツの製品は、[テキサス・インスツルメンツの販売条件](#)、または [ti.com](https://www.ti.com) やかかるテキサス・インスツルメンツ製品の関連資料などのいずれかを通じて提供する適用可能な条項の下で提供されています。テキサス・インスツルメンツがこれらのリソースを提供することは、適用されるテキサス・インスツルメンツの保証または他の保証の放棄の拡大や変更を意味するものではありません。

お客様がいかなる追加条項または代替条項を提案した場合でも、テキサス・インスツルメンツはそれらに異議を唱え、拒否します。

郵送先住所：Texas Instruments, Post Office Box 655303, Dallas, Texas 75265  
Copyright © 2025, Texas Instruments Incorporated