

TPS2290x 可変高速ターンオン機能搭載、3.6V、500-mA、78mΩ オン抵抗ロード・スイッチ

1 特長

- 統合型 P チャネル・ロード・スイッチ
- 低入力電圧：1 V ~ 3.6 V
- オン抵抗 (標準値)
 - $r_{ON} = 78\text{m}\Omega$ ($V_{IN} = 3.6\text{V}$ の場合)
 - $r_{ON} = 93\text{m}\Omega$ ($V_{IN} = 2.5\text{V}$ の場合)
 - $r_{ON} = 109\text{m}\Omega$ ($V_{IN} = 1.8\text{V}$ の場合)
 - $r_{ON} = 146\text{m}\Omega$ ($V_{IN} = 1.2\text{V}$ の場合)
- 最大連続スイッチ電流：500mA
- 静止電流: 82nA (1.8V の場合)
- シャットダウン電流：44nA (1.8V の場合)
- 制御入力スレッシュホールドが低いため 1.2V、1.8V、2.5V、3.3V ロジックを使用可能
- スルーレートを制御することで突入電流を防止
 - $t_r = 40\mu\text{s}$ ($V_{IN} = 1.8\text{V}$ の場合) (TPS22901/2)
 - $t_r = 220\mu\text{s}$ ($V_{IN} = 1.8\text{V}$ の場合) (TPS22902B)
- クイック出力放電 (QOD) (TPS22902/2B)
- JESD 22 準拠で ESD 性能をテスト済み
 - 2000V、人体モデル (A114-B, Class II)
 - 1000V、荷電デバイス・モデル (C101)
- 4 ピンのウエハ・チップ・スケール DSBGA パッケージ
 - 0.8mm×0.8mm、0.4mm ピッチ、高さ 0.5mm (YFP)

2 アプリケーション

- パーソナル・デジタル・アシスタント(PDA)
- 携帯電話
- GPS デバイス
- MP3 プレーヤー
- デジタル・カメラ
- ペリフェラル・ポート
- ポータブル機器
- RF モジュール

3 概要

TPS22901、TPS22902、TPS22902B は、制御ターンオン機能を備えた小型でオン抵抗 (r_{ON}) が小さいロード・スイッチです。これらのデバイスには、1.0V~3.6V の入力電圧範囲で動作する P チャネル MOSFET が内蔵されています。本スイッチはオン / オフ入力 (ON) で制御され、低電圧制御信号と直接接続できます。TPS22902 および TPS22902B では、スイッチをオフにした際に出力を速やかに放電させるための 88Ω のオンチップ負荷抵抗が追加されています。

TPS22901、TPS22902、TPS22902B は、0.4mm ピッチの省スペース 4 ピン DSBGA (YFP) で提供しています。これらのデバイスは、 $-40^{\circ}\text{C} \sim 85^{\circ}\text{C}$ の温度範囲 (自由通気) で動作が規定されています。

製品情報

型番	パッケージ ⁽¹⁾ (1 ページ)	本体サイズ (公称)
TPS22901	DSBGA (4)	0.80mm×0.80mm
TPS22902		
TPS22902B		

(1) 利用可能なすべてのパッケージについては、このデータシートの末尾にある注文情報を参照してください。

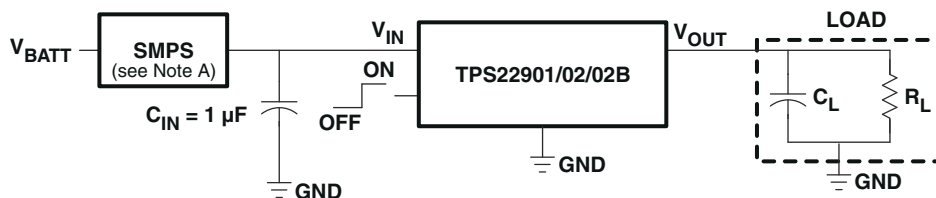

A. スイッチ・モード電源

代表的なアプリケーション回路図



Table of Contents

1 特長	1	9 Detailed Description	20
2 アプリケーション	1	9.1 Overview.....	20
3 概要	1	9.2 Functional Block Diagram.....	20
4 Revision History	2	9.3 Feature Description.....	20
5 Device Comparison Table	3	9.4 Device Functional Modes.....	20
6 Pin Configuration and Functions	3	10 Application and Implementation	21
7 Specifications	4	10.1 Application Information.....	21
7.1 Absolute Maximum Ratings.....	4	10.2 Typical Application.....	21
7.2 ESD Ratings.....	4	11 Power Supply Recommendations	24
7.3 Recommended Operating Conditions.....	4	12 Layout	24
7.4 Thermal Information.....	4	12.1 Layout Guidelines.....	24
7.5 Electrical Characteristics.....	5	12.2 Layout Example.....	24
7.6 Switching Characteristics ($V_{IN} = 1.1\text{ V}$).....	6	13 Device and Documentation Support	25
7.7 Switching Characteristics ($V_{IN} = 1.2\text{ V}$).....	6	13.1 Related Links.....	25
7.8 Switching Characteristics ($V_{IN} = 1.8\text{ V}$).....	7	13.2 Trademarks.....	25
7.9 Switching Characteristics ($V_{IN} = 2.5\text{ V}$).....	7	13.3 Electrostatic Discharge Caution.....	25
7.10 Switching Characteristics ($V_{IN} = 3.0\text{ V}$).....	8	13.4 Glossary.....	25
7.11 Switching Characteristics ($V_{IN} = 3.6\text{ V}$).....	8	14 Mechanical, Packaging, and Orderable Information	25
7.12 Typical Characteristics.....	9		
8 Parameter Measurement Information	19		

4 Revision History

資料番号末尾の英字は改訂を表しています。その改訂履歴は英語版に準じています。

Changes from Revision D (January 2015) to Revision E (September 2020)	Page
• 文書全体にわたって表、図、相互参照の採番方法を更新.....	1

Changes from Revision C (December 2012) to Revision D (January 2015)	Page
• 「ESD 定格」の表、「機能説明」セクション、「デバイスの機能モード」セクション、「アプリケーションと実装」セクション、「電源に関する推奨事項」セクション、「レイアウト」セクション、「デバイスおよびドキュメントのサポート」セクション、「メカニカル、パッケージ、および注文情報」セクションを追加.....	1
• Deleted the <i>ORDERING INFORMATION</i> table.....	3

Changes from Revision B (March 2009) to Revision C (December 2012)	Page
• Changed the <i>ORDERING INFORMATION</i> table.....	3

5 Device Comparison Table

	R _{ON} at 1.8 V (TYP)	RISE TIME (TYP at 1.8 V)	QUICK OUTPUT DISCHARGE ⁽¹⁾	MAX OUTPUT CURRENT	ENABLE
TPS22901	109 mΩ	40 μs	No	500 mA	Active high
TPS22902			Yes		
TPS22902B		220 μs	Yes		

(1) This feature discharges the output of the switch to ground through an 88 Ω resistor, preventing the output from floating.

6 Pin Configuration and Functions

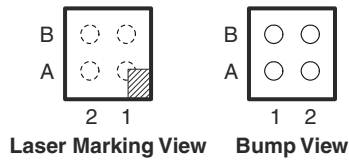

6-1. YFP Package 4-Pin DSBGA

Pin Assignments

B	ON	GND
A	V _{IN}	V _{OUT}
	2	1

Pin Functions

PIN		I/O	DESCRIPTION
NO.	NAME		
A1	V _{OUT}	O	Switch output
A2	V _{IN}	I	Switch input, bypass this input with a ceramic capacitor to ground
B1	GND	-	Ground
B2	ON	I	Switch control input, active high

7 Specifications

7.1 Absolute Maximum Ratings

over operating free-air temperature range (unless otherwise noted)⁽¹⁾

		MIN	MAX	UNIT
V _{IN}	Input voltage	-0.3	4	V
V _{OUT}	Output voltage		V _{IN} + 0.3	V
V _{ON}	Input voltage	-0.3	4	V
P	Power dissipation at T _A = 25°C		0.48	W
I _{MAX}	Maximum continuous switch current		500	mA
T _A	Operating free-air temperature	-40	85	°C
T _{lead}	Maximum lead temperature (10-s soldering time)		300	°C
T _{stg}	Storage temperature	-65	150	°C

- (1) Stresses beyond those listed under *Absolute Maximum Ratings* may cause permanent damage to the device. These are stress ratings only, which do not imply functional operation of the device at these or any other conditions beyond those indicated under [セクション 7.3](#). Exposure to absolute-maximum-rated conditions for extended periods may affect device reliability.

7.2 ESD Ratings

		VALUE	UNIT
V _(ESD)	Electrostatic discharge	Human body model (HBM), per ANSI/ESDA/JEDEC JS-001 ⁽¹⁾	±2000
		Charged-device model (CDM), per JEDEC specification JESD22-C101 ⁽²⁾	±1000

- (1) JEDEC document JEP155 states that 500-V HBM allows safe manufacturing with a standard ESD control process.
 (2) JEDEC document JEP157 states that 250-V CDM allows safe manufacturing with a standard ESD control process.

7.3 Recommended Operating Conditions

		MIN	MAX	UNIT
V _{IN}	Input voltage	1	3.6	V
V _{OUT}	Output voltage		V _{IN}	V
V _{IH}	High-level input voltage, ON	0.85	3.6	V
V _{IL}	Low-level input voltage, ON		0.4	V
C _{IN}	Input capacitor	See ⁽¹⁾		µF

- (1) See [セクション 10.1.1](#).

7.4 Thermal Information

THERMAL METRIC ⁽¹⁾		TPS2290X	UNIT
		YFP (DSBGA)	
		4 PINS	
R _{θJA}	Junction-to-ambient thermal resistance	192.1	°C/W
R _{θJC(top)}	Junction-to-case (top) thermal resistance	2.3	
R _{θJB}	Junction-to-board thermal resistance	35.8	
Ψ _{JT}	Junction-to-top characterization parameter	11.8	
Ψ _{JB}	Junction-to-board characterization parameter	35.6	

- (1) For more information about traditional and new thermal metrics, see the *IC Package Thermal Metrics* application report, [SPRA953](#).

7.5 Electrical Characteristics

$V_{IN} = 1.0\text{ V to }3.6\text{ V}$, $T_A = -40^\circ\text{C to }85^\circ\text{C}$ (unless otherwise noted). Typical values are for $T_A = 25^\circ\text{C}$

PARAMETER		TEST CONDITIONS	T_A	MIN	TYP	MAX	UNIT
I_Q	Quiescent current	$I_{OUT} = 0$, $V_{IN} = V_{ON}$	$V_{IN} = 1.1\text{ V}$	Full	37	120	nA
			$V_{IN} = 1.8\text{ V}$	Full	82	235	
			$V_{IN} = 3.6\text{ V}$	Full	204	880	
$I_{IN(OFF)}$	OFF-state supply current	$V_{ON} = \text{GND}$, $V_{OUT} = \text{Open}$	$V_{IN} = 1.1\text{ V}$	Full	22	210	nA
			$V_{IN} = 1.8\text{ V}$	Full	44	260	
			$V_{IN} = 3.6\text{ V}$	Full	137	700	
$I_{IN(LEAKAGE)}$	OFF-state switch current	$V_{ON} = \text{GND}$, $V_{OUT} = 0\text{ V}$	$V_{IN} = 1.1\text{ V}$	Full	22	140	nA
			$V_{IN} = 1.8\text{ V}$	Full	45	230	
			$V_{IN} = 3.6\text{ V}$	Full	137	610	
r_{ON}	ON-state resistance	$I_{OUT} = -200\text{ mA}$	$V_{IN} = 3.6\text{ V}$	25°C	78	95	m Ω
				Full		95	
			$V_{IN} = 2.5\text{ V}$	25°C	93	110	
				Full		110	
			$V_{IN} = 1.8\text{ V}$	25°C	109	130	
				Full		130	
			$V_{IN} = 1.2\text{ V}$	25°C	146	200	
				Full		200	
$V_{IN} = 1.1\text{ V}$	25°C	174	330				
	Full		330				
r_{PD}	Output pulldown resistance	$V_{IN} = 3.3\text{ V}$, $V_{ON} = 0$, $I_{OUT} = 30\text{ mA}$ (TPS22902/TPS22902B only)	25°C		88	120	Ω
I_{ON}	ON input leakage current	$V_{ON} = 1.1\text{ V to }3.6\text{ V or GND}$	Full			25	nA

7.6 Switching Characteristics ($V_{IN} = 1.1\text{ V}$)

$V_{IN} = 1.1\text{ V}$, $T_A = 25^\circ\text{C}$ (unless otherwise noted)

PARAMETER	TEST CONDITIONS		TPS22901			TPS22902 ⁽¹⁾			TPS22902B ⁽¹⁾			UNIT
			MIN	TYP	MAX	MIN	TYP	MAX	MIN	TYP	MAX	
t_{ON} Turn-ON time	$R_L = 500\ \Omega$	$C_L = 0.1\ \mu\text{F}$	108			108			531			μs
		$C_L = 1\ \mu\text{F}$	131			131			596			
		$C_L = 3.3\ \mu\text{F}$	153			153			659			
t_{OFF} Turn-OFF time	$R_L = 500\ \Omega$	$C_L = 0.1\ \mu\text{F}$	39			11			11			μs
		$C_L = 1\ \mu\text{F}$	317			69			67			
		$C_L = 3.3\ \mu\text{F}$	1105			238			225			
t_r V_{OUT} rise time	$R_L = 500\ \Omega$	$C_L = 0.1\ \mu\text{F}$	70			70			365			μs
		$C_L = 1\ \mu\text{F}$	78			78			367			
		$C_L = 3.3\ \mu\text{F}$	92			92			395			
t_f V_{OUT} fall time	$R_L = 500\ \Omega$	$C_L = 0.1\ \mu\text{F}$	107			18			21			μs
		$C_L = 1\ \mu\text{F}$	966			175			189			
		$C_L = 3.3\ \mu\text{F}$	3532			632			565			

(1) Quick Output Discharge

7.7 Switching Characteristics ($V_{IN} = 1.2\text{ V}$)

$V_{IN} = 1.2\text{ V}$, $T_A = 25^\circ\text{C}$ (unless otherwise noted)

PARAMETER	TEST CONDITIONS		TPS22901			TPS22902 ⁽¹⁾			TPS22902B ⁽¹⁾			UNIT
			MIN	TYP	MAX	MIN	TYP	MAX	MIN	TYP	MAX	
t_{ON} Turn-ON time	$R_L = 500\ \Omega$	$C_L = 0.1\ \mu\text{F}$	96			96			471			μs
		$C_L = 1\ \mu\text{F}$	116			116			527			
		$C_L = 3.3\ \mu\text{F}$	135			135			587			
t_{OFF} Turn-OFF time	$R_L = 500\ \Omega$	$C_L = 0.1\ \mu\text{F}$	39			10			10			μs
		$C_L = 1\ \mu\text{F}$	317			62			61			
		$C_L = 3.3\ \mu\text{F}$	1110			210			199			
t_r V_{OUT} rise time	$R_L = 500\ \Omega$	$C_L = 0.1\ \mu\text{F}$	62			62			324			μs
		$C_L = 1\ \mu\text{F}$	69			69			325			
		$C_L = 3.3\ \mu\text{F}$	81			81			350			
t_f V_{OUT} fall time	$R_L = 500\ \Omega$	$C_L = 0.1\ \mu\text{F}$	109			17			20			μs
		$C_L = 1\ \mu\text{F}$	995			163			175			
		$C_L = 3.3\ \mu\text{F}$	3650			587			523			

(1) Quick Output Discharge

7.8 Switching Characteristics ($V_{IN} = 1.8\text{ V}$)

 $V_{IN} = 1.8\text{ V}$, $T_A = 25^\circ\text{C}$ (unless otherwise noted)

PARAMETER	TEST CONDITIONS		TPS22901			TPS22902 ⁽¹⁾			TPS22902B ⁽¹⁾			UNIT
			MIN	TYP	MAX	MIN	TYP	MAX	MIN	TYP	MAX	
t_{ON} Turn-ON time	$R_L = 500\ \Omega$	$C_L = 0.1\ \mu\text{F}$	61			61			302			μs
		$C_L = 1\ \mu\text{F}$	72			72			335			
		$C_L = 3.3\ \mu\text{F}$	83			83			367			
t_{OFF} Turn-OFF time	$R_L = 500\ \Omega$	$C_L = 0.1\ \mu\text{F}$	38			8			8			μs
		$C_L = 1\ \mu\text{F}$	317			49			49			
		$C_L = 3.3\ \mu\text{F}$	1135			169			167			
t_r V_{OUT} rise time	$R_L = 500\ \Omega$	$C_L = 0.1\ \mu\text{F}$	40			40			220			μs
		$C_L = 1\ \mu\text{F}$	45			45			220			
		$C_L = 3.3\ \mu\text{F}$	53			53			235			
t_f V_{OUT} fall time	$R_L = 500\ \Omega$	$C_L = 0.1\ \mu\text{F}$	111			15			15			μs
		$C_L = 1\ \mu\text{F}$	1020			140			159			
		$C_L = 3.3\ \mu\text{F}$	3700			517			481			

(1) Quick Output Discharge

7.9 Switching Characteristics ($V_{IN} = 2.5\text{ V}$)

 $V_{IN} = 2.5\text{ V}$, $T_A = 25^\circ\text{C}$ (unless otherwise noted)

PARAMETER	TEST CONDITIONS		TPS22901			TPS22902 ⁽¹⁾			TPS22902B ⁽¹⁾			UNIT
			MIN	TYP	MAX	MIN	TYP	MAX	MIN	TYP	MAX	
t_{ON} Turn-ON time	$R_L = 500\ \Omega$	$C_L = 0.1\ \mu\text{F}$	45			45			223			μs
		$C_L = 1\ \mu\text{F}$	53			53			246			
		$C_L = 3.3\ \mu\text{F}$	61			61			268			
t_{OFF} Turn-OFF time	$R_L = 500\ \Omega$	$C_L = 0.1\ \mu\text{F}$	38			7			7			μs
		$C_L = 1\ \mu\text{F}$	314			46			47			
		$C_L = 3.3\ \mu\text{F}$	1140			161			158			
t_r V_{OUT} rise time	$R_L = 500\ \Omega$	$C_L = 0.1\ \mu\text{F}$	32			32			175			μs
		$C_L = 1\ \mu\text{F}$	35			35			175			
		$C_L = 3.3\ \mu\text{F}$	41			41			187			
t_f V_{OUT} fall time	$R_L = 500\ \Omega$	$C_L = 0.1\ \mu\text{F}$	113			14			18			μs
		$C_L = 1\ \mu\text{F}$	1040			139			185			
		$C_L = 3.3\ \mu\text{F}$	3795			516			471			

(1) Quick Output Discharge

7.10 Switching Characteristics (V_{IN} = 3.0 V)

V_{IN} = 3.0 V, T_A = 25°C (unless otherwise noted)

PARAMETER	TEST CONDITIONS		TPS22901			TPS22902 ⁽¹⁾			TPS22902B ⁽¹⁾			UNIT
			MIN	TYP	MAX	MIN	TYP	MAX	MIN	TYP	MAX	
t _{ON} Turn-ON time	R _L = 500 Ω	C _L = 0.1 μF	38			38			191			μs
		C _L = 1 μF	45			45			211			
		C _L = 3.3 μF	53			53			231			
t _{OFF} Turn-OFF time	R _L = 500 Ω	C _L = 0.1 μF	38			7			7			μs
		C _L = 1 μF	320			46			46			
		C _L = 3.3 μF	1145			53			156			
t _r V _{OUT} rise time	R _L = 500 Ω	C _L = 0.1 μF	28			28			159			μs
		C _L = 1 μF	31			31			160			
		C _L = 3.3 μF	37			37			170			
t _f V _{OUT} fall time	R _L = 500 Ω	C _L = 0.1 μF	114			14			17			μs
		C _L = 1 μF	1045			139			160			
		C _L = 3.3 μF	3815			509			473			

(1) Quick Output Discharge

7.11 Switching Characteristics (V_{IN} = 3.6 V)

V_{IN} = 3.6 V, T_A = 25°C (unless otherwise noted)

PARAMETER	TEST CONDITIONS		TPS22901			TPS22902 ⁽¹⁾			TPS22902B ⁽¹⁾			UNIT
			MIN	TYP	MAX	MIN	TYP	MAX	MIN	TYP	MAX	
t _{ON} Turn-ON time	R _L = 500 Ω	C _L = 0.1 μF	33			33			166			μs
		C _L = 1 μF	39			39			183			
		C _L = 3.3 μF	46			46			201			
t _{OFF} Turn-OFF time	R _L = 500 Ω	C _L = 0.1 μF	38			7			7			μs
		C _L = 1 μF	322			46			45			
		C _L = 3.3 μF	1145			156			155			
t _r V _{OUT} rise time	R _L = 500 Ω	C _L = 0.1 μF	25			25			146			μs
		C _L = 1 μF	28			28			146			
		C _L = 3.3 μF	34			34			156			
t _f V _{OUT} fall time	R _L = 500 Ω	C _L = 0.1 μF	116			14			17			μs
		C _L = 1 μF	1060			139			161			
		C _L = 3.3 μF	3840			512			475			

(1) Quick Output Discharge

7.12 Typical Characteristics

7.12.1 Typical DC Characteristics

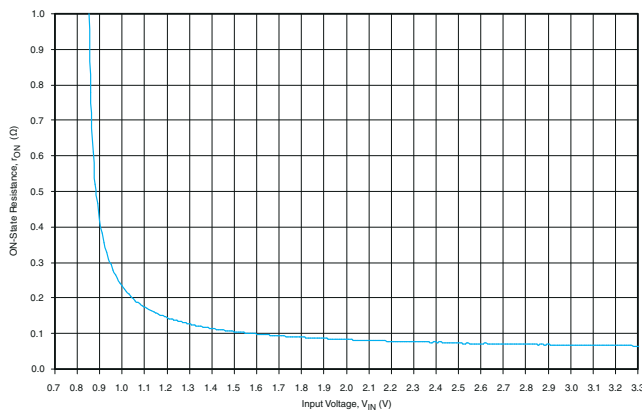

7-1. r_{ON} vs V_{IN}

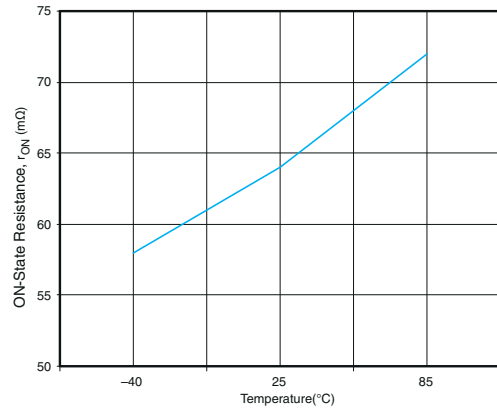

7-2. r_{ON} vs Temperature ($V_{IN} = 3.3$ V)

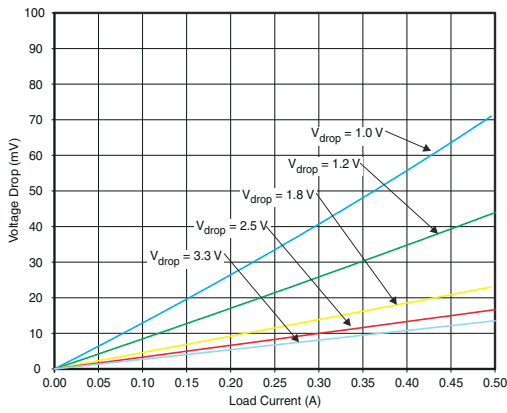

7-3. Voltage Drop vs. Load Current

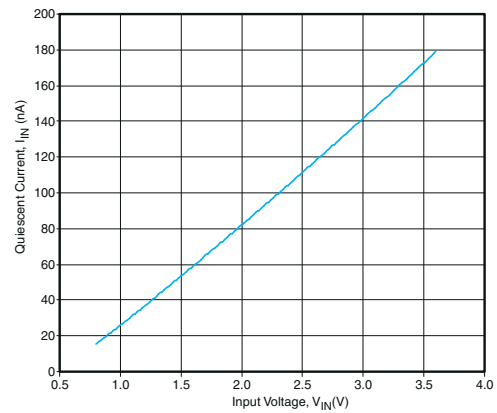

7-4. Quiescent Current vs V_{IN} ($V_{ON} = V_{IN}$, $I_{OUT} = 0$)

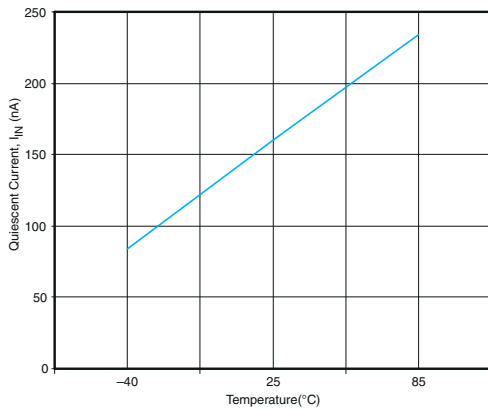

7-5. Quiescent Current vs Temperature ($V_{IN} = 3.3$ V, $I_{OUT} = 0$)

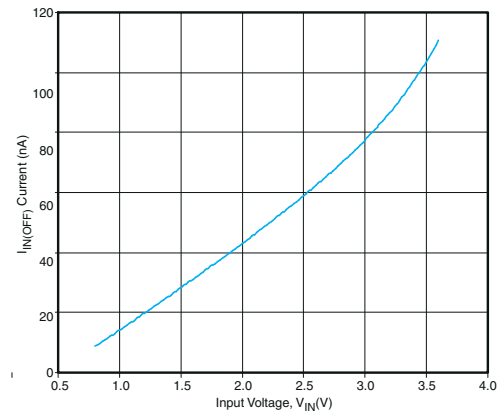

7-6. $I_{IN(OFF)}$ vs V_{IN} ($V_{ON} = 0$ V)

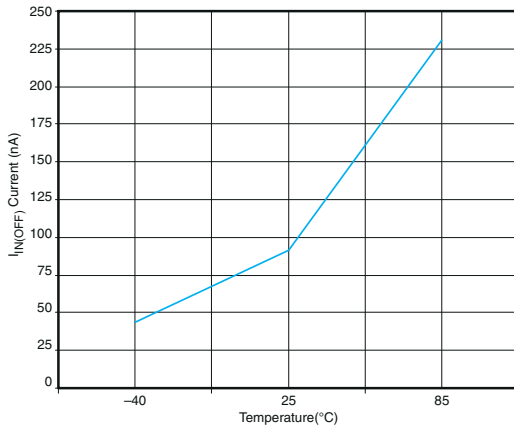

7-7. $I_{IN(OFF)}$ vs Temperature ($V_{IN} = 3.3$ V)

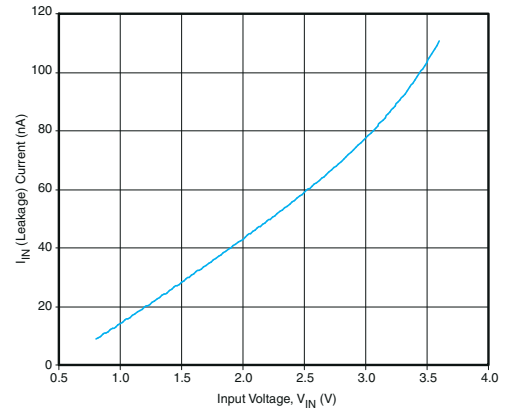

7-8. I_{IN} (Leakage) vs V_{IN} ($I_{OUT} = 0$)

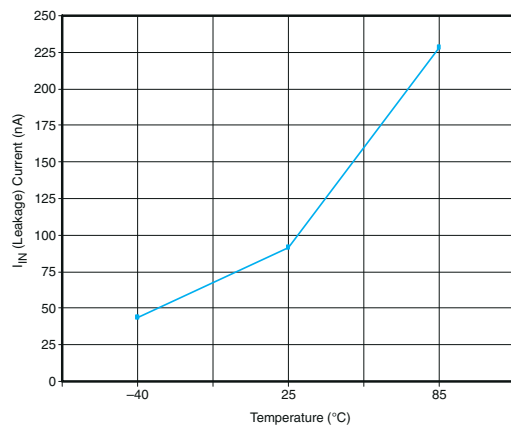

7-9. I_{IN} (Leakage) vs Temperature ($V_{IN} = 3.3$ V)

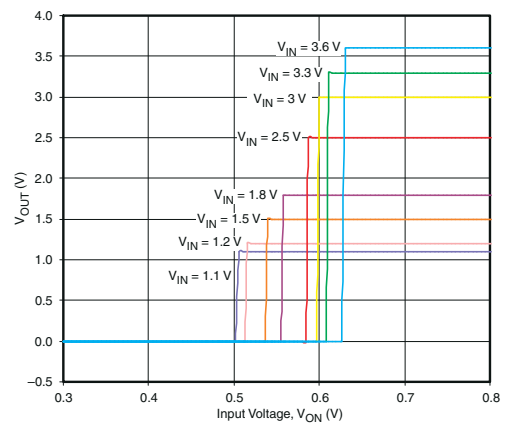

7-10. ON-Input Threshold

7.12.2 Typical AC Characteristics

7.12.2.1 TPS22901

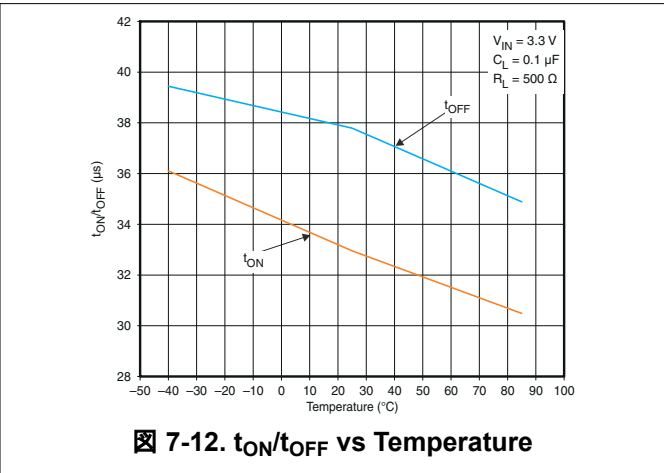
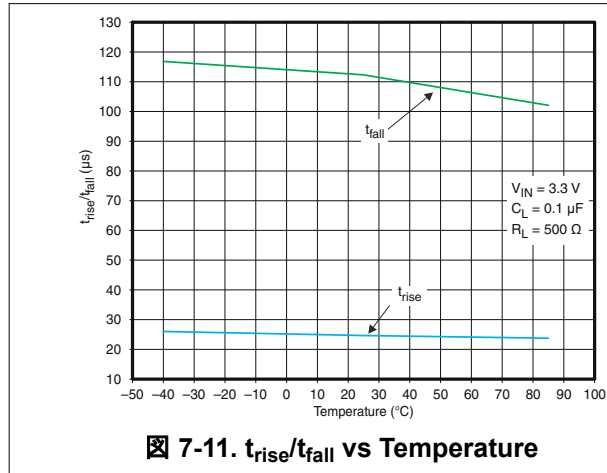

7.12.2.2 TPS22902

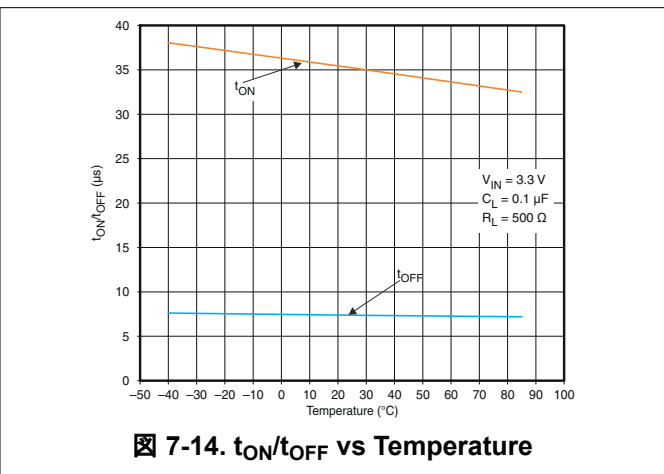
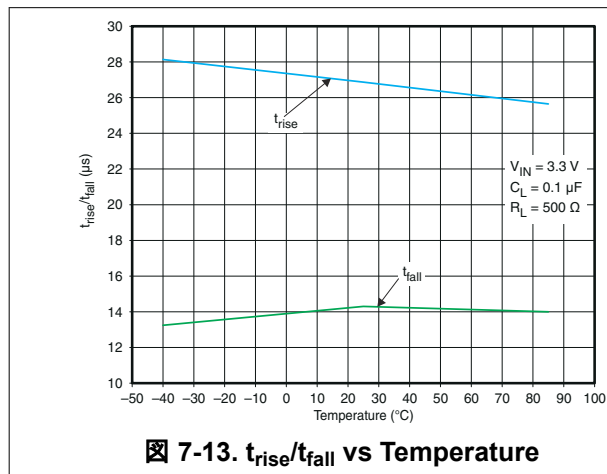

7.12.2.3 TPS22902B

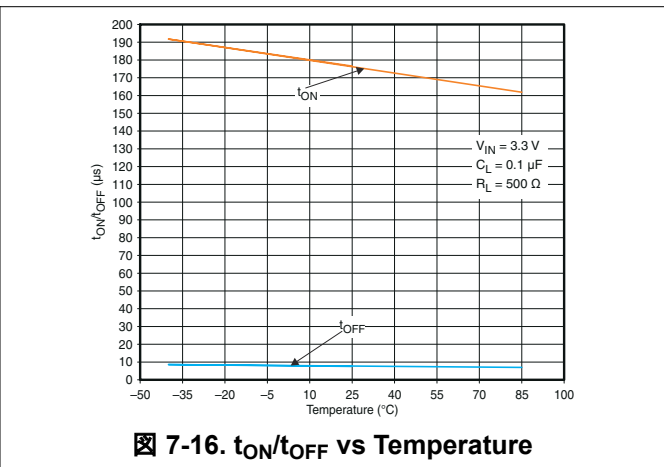
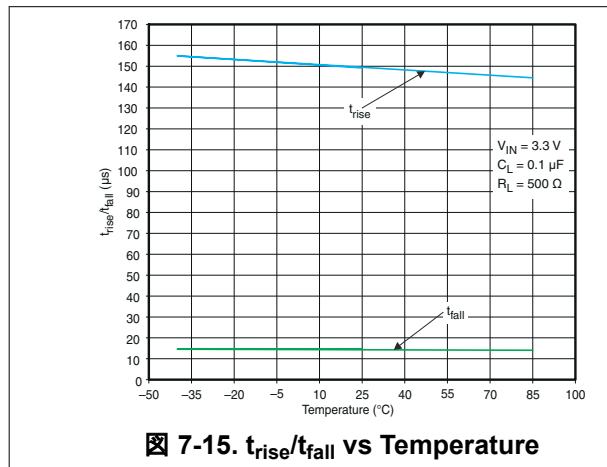

TPS22901, TPS22902, TPS22902B

JAJST3E – NOVEMBER 2008 – REVISED SEPTEMBER 2020

7.12.2.4 TPS22901 and TPS22902

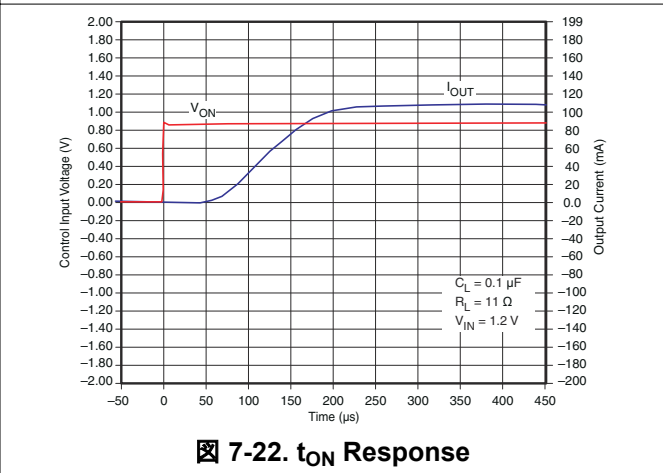
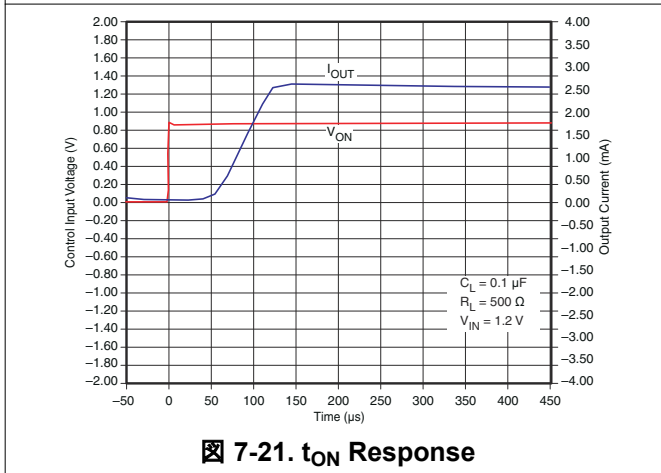
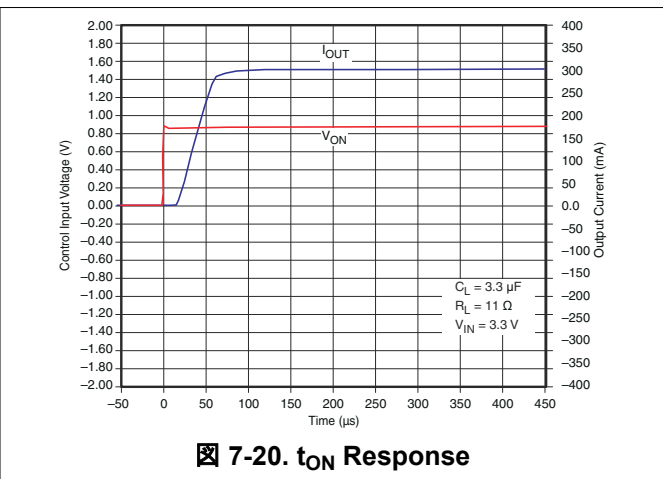
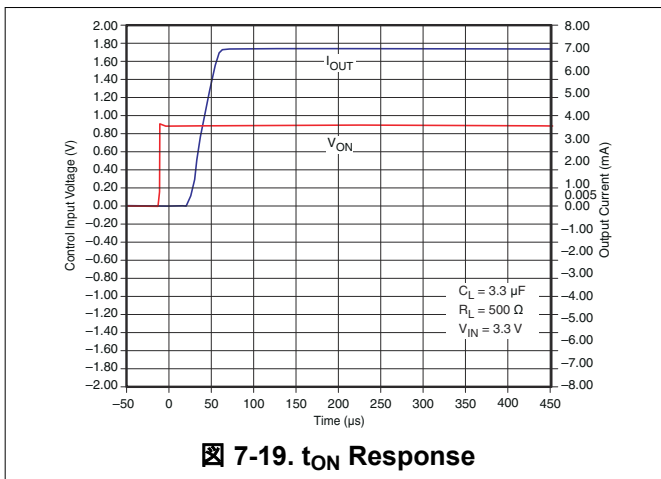
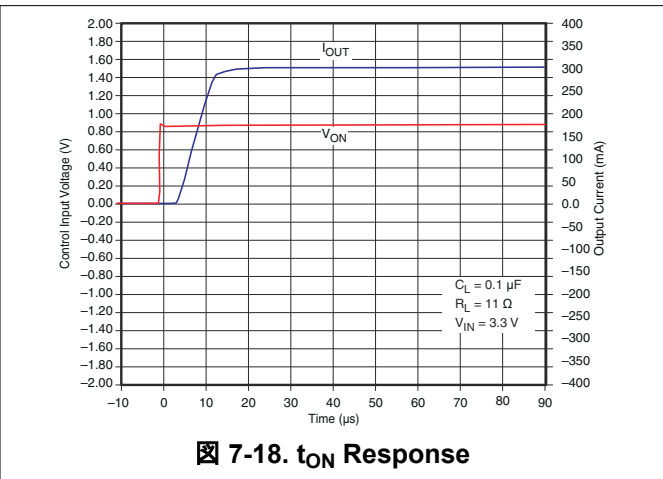
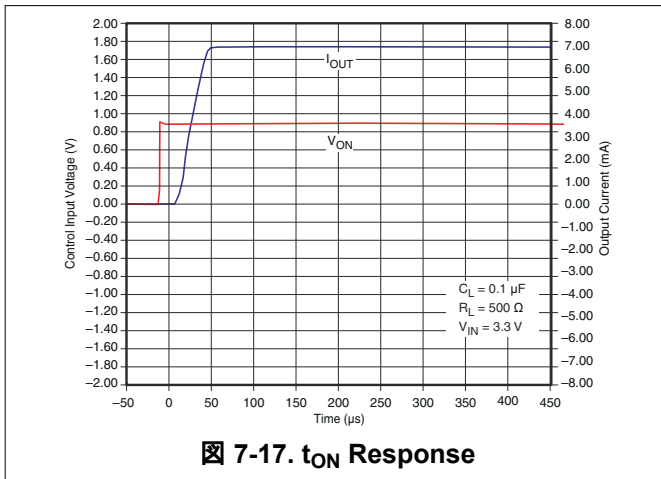

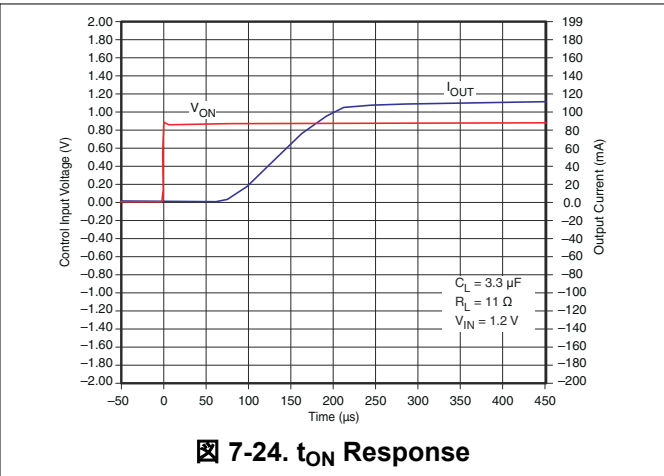
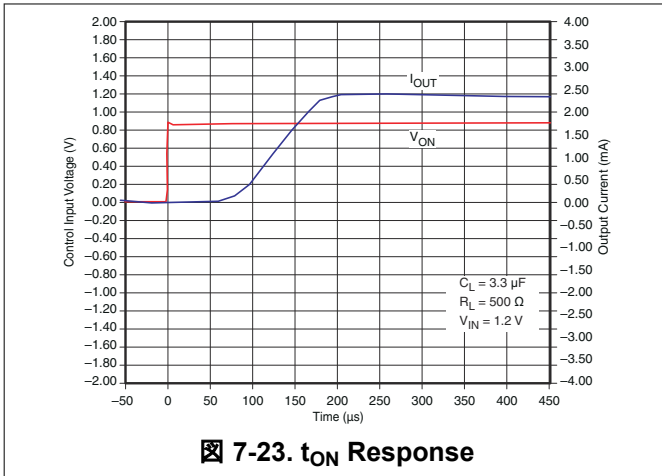

7.12.2.5 TPS22901

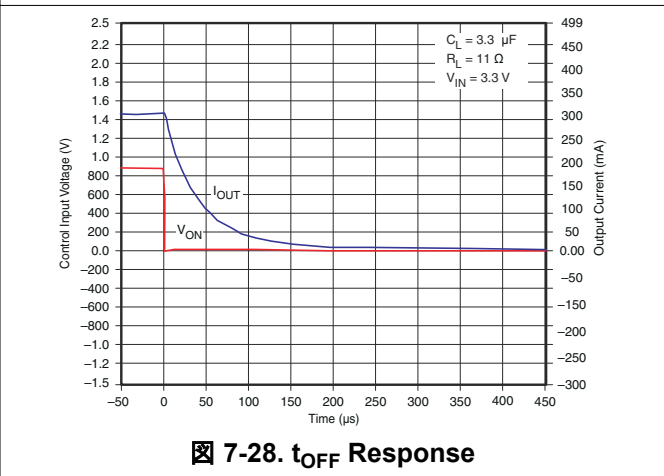
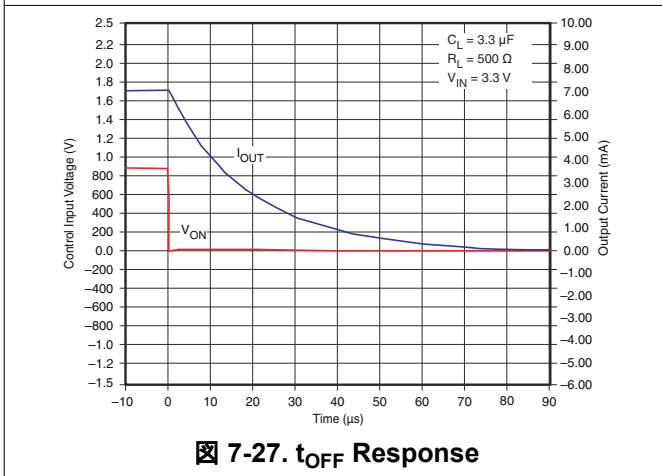
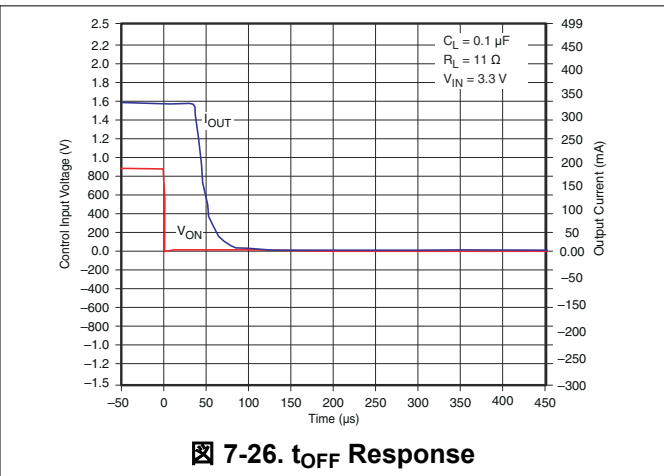
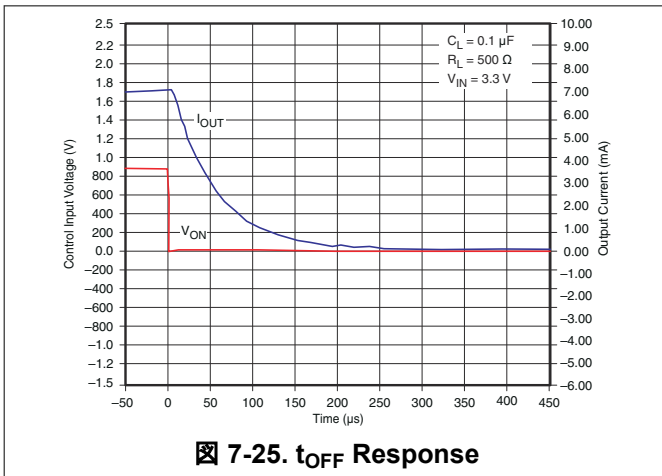

TPS22901, TPS22902, TPS22902B

JAJSJT3E – NOVEMBER 2008 – REVISED SEPTEMBER 2020



图 7-29. t_{OFF} Response



图 7-30. t_{OFF} Response

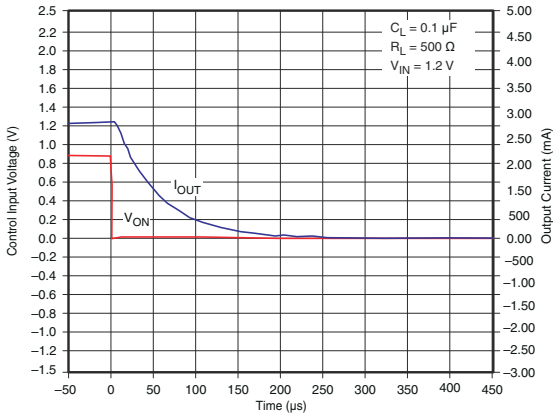

图 7-31. t_{OFF} Response

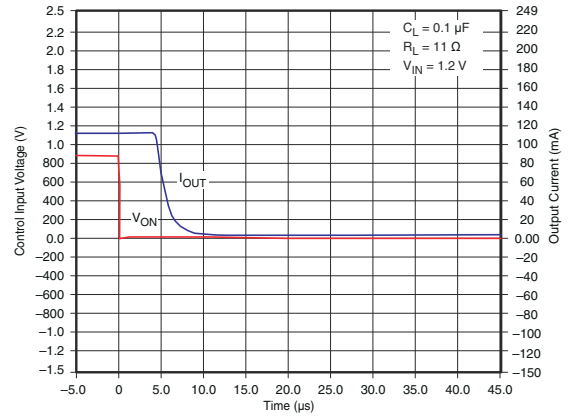

图 7-32. t_{OFF} Response

7.12.2.6 TPS22902

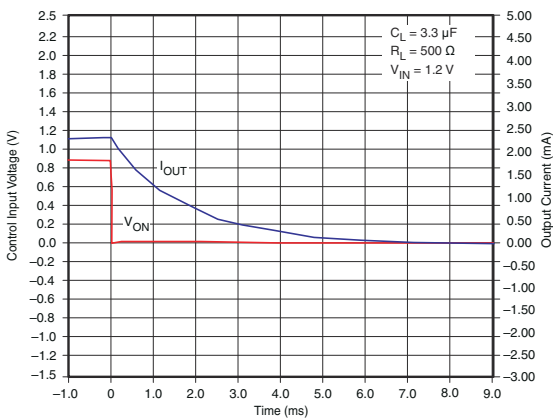

图 7-33. t_{OFF} Response

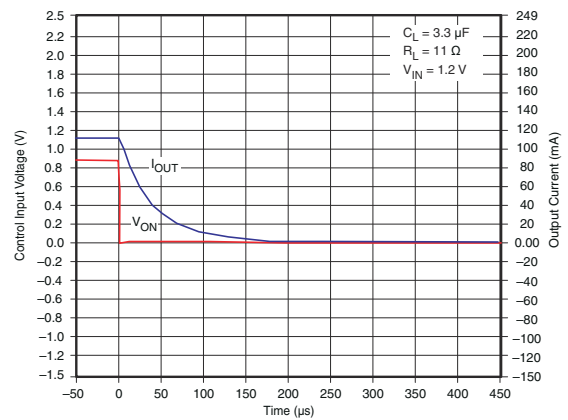

图 7-34. t_{OFF} Response

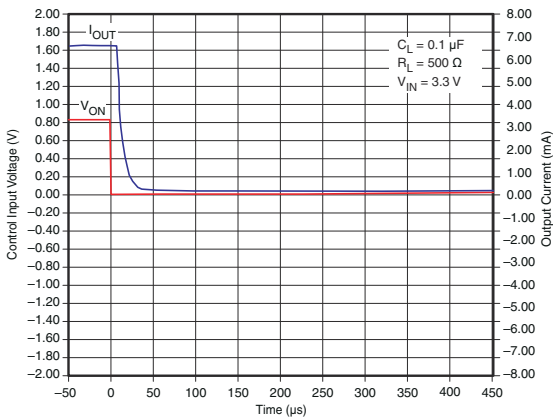

图 7-35. t_{OFF} Response

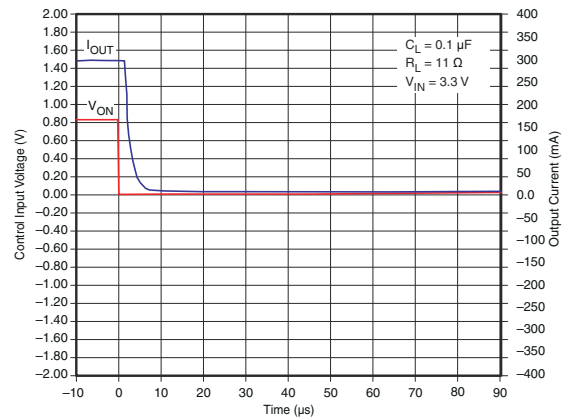

图 7-36. t_{OFF} Response

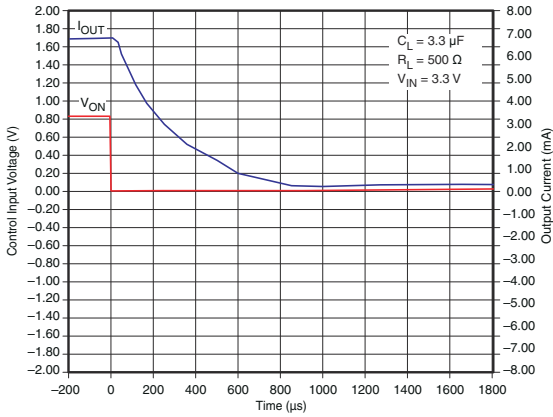

图 7-37. t_{OFF} Response

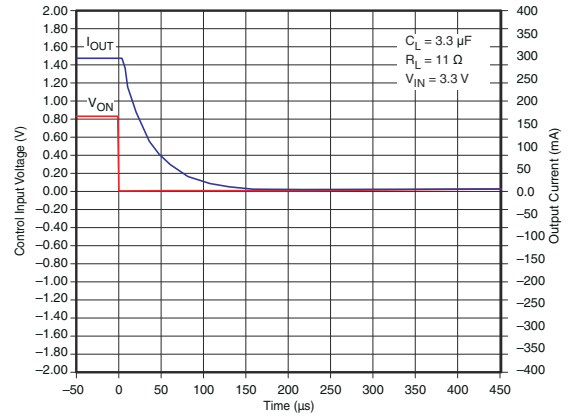

图 7-38. t_{OFF} Response

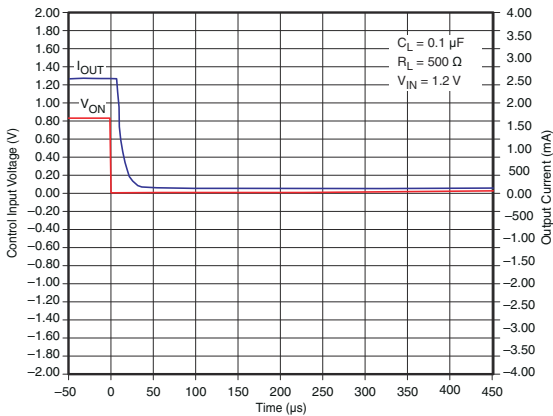

图 7-39. t_{OFF} Response

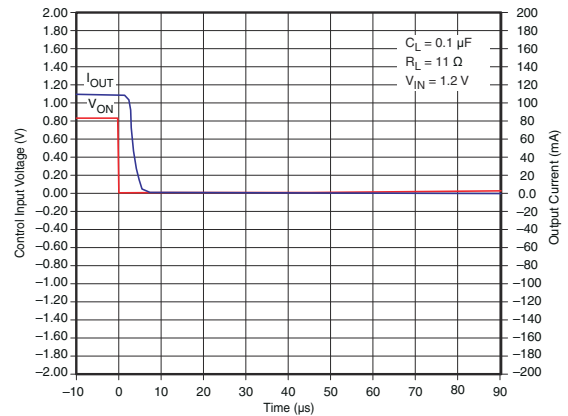

图 7-40. t_{OFF} Response

7.12.2.7 TPS22902B

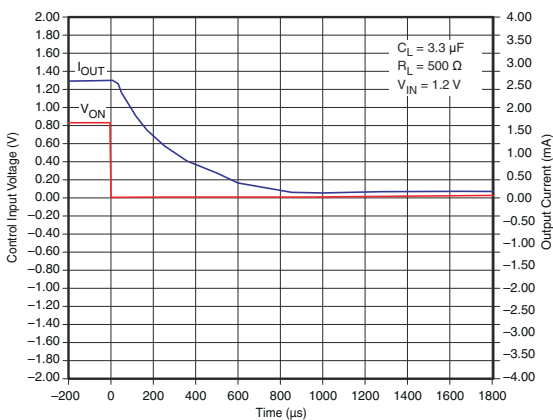

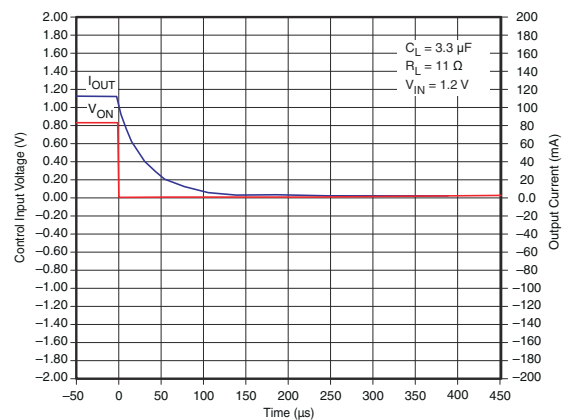
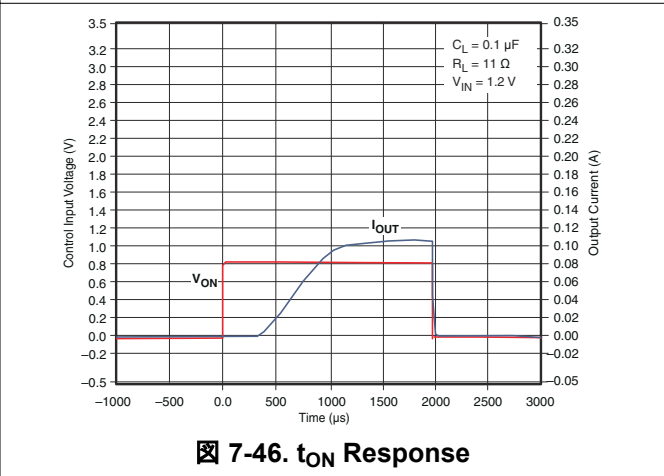
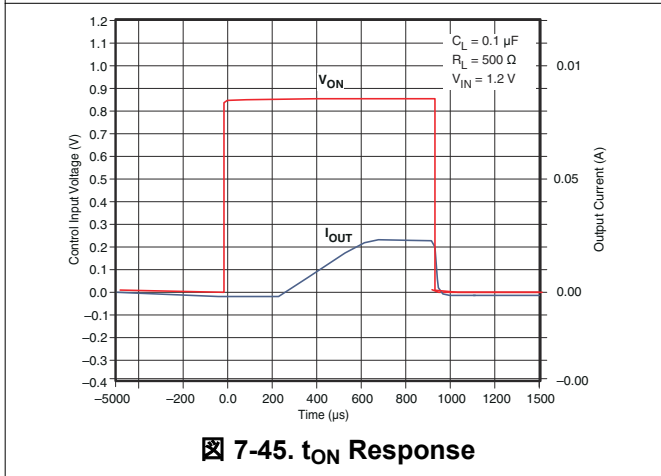
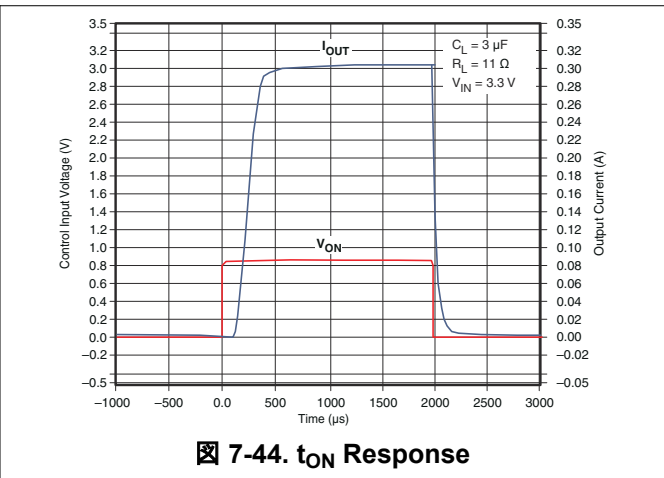
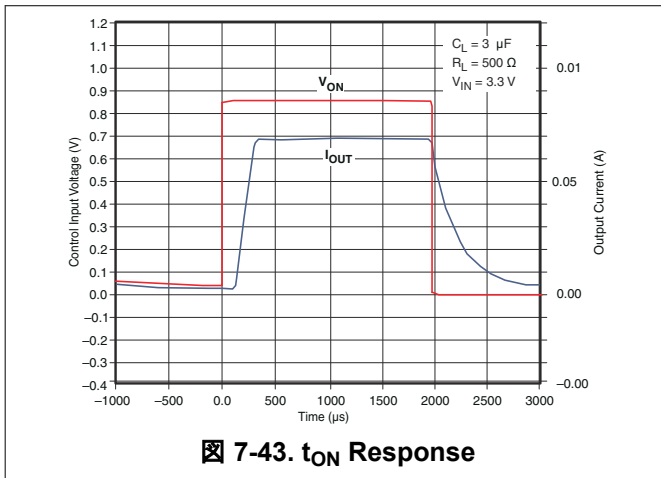
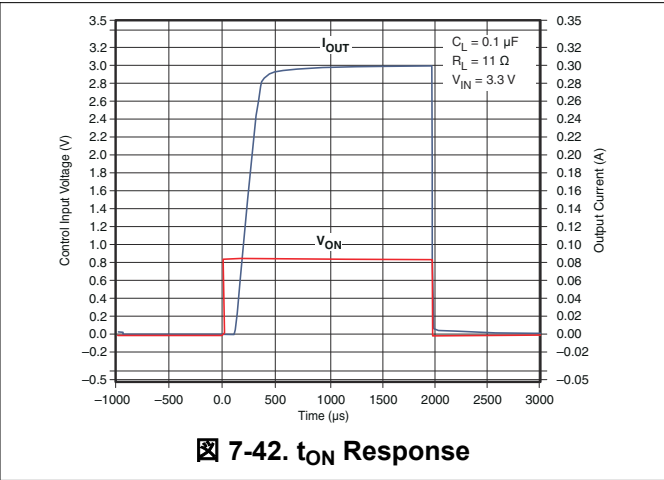
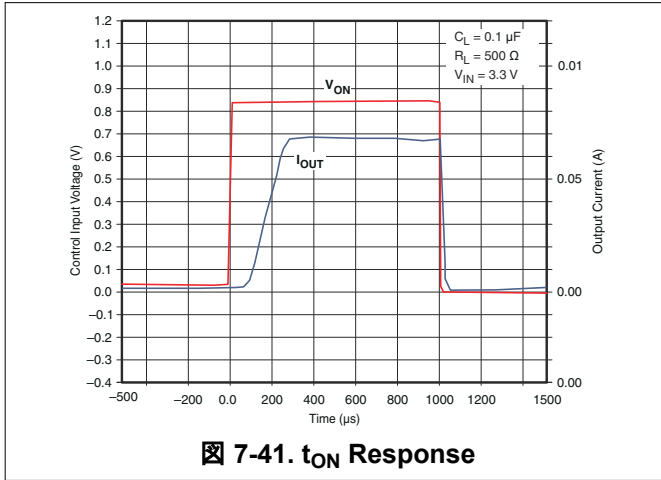

图 7-47. t_{ON} Response



图 7-48. t_{ON} Response

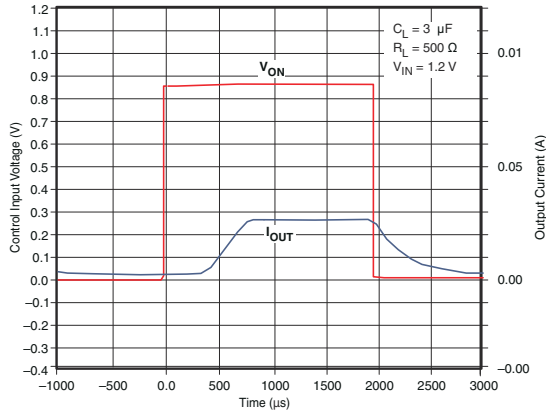

图 7-49. t_{OFF} Response

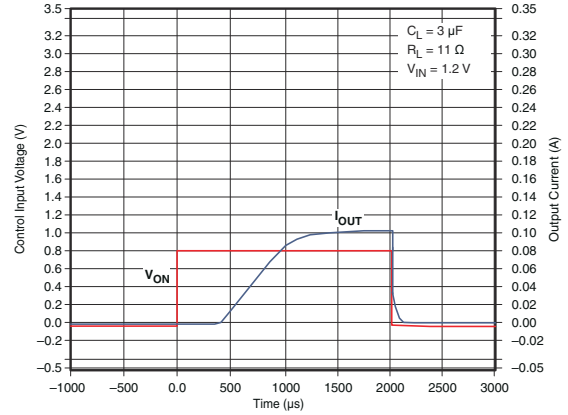

图 7-50. t_{OFF} Response

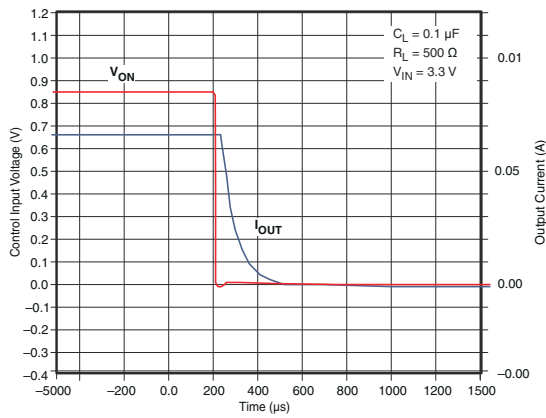

图 7-51. t_{OFF} Response

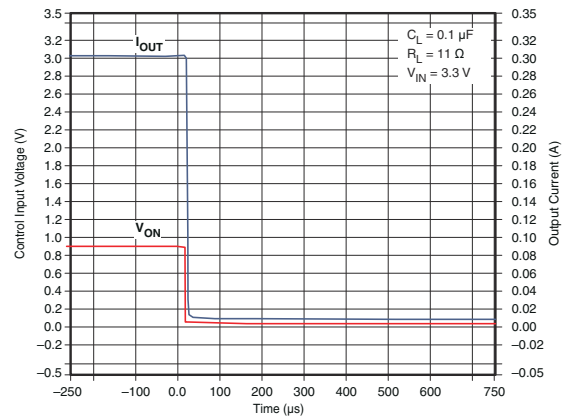

图 7-52. t_{OFF} Response

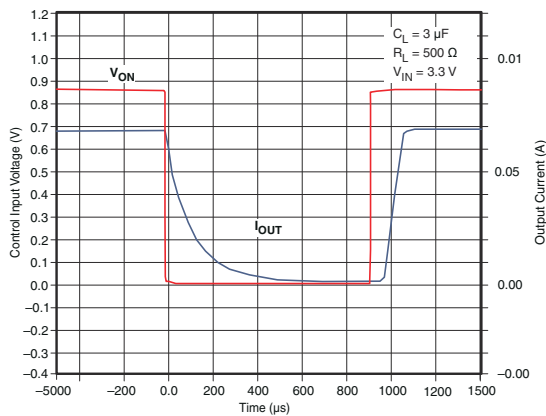

图 7-53. t_{OFF} Response

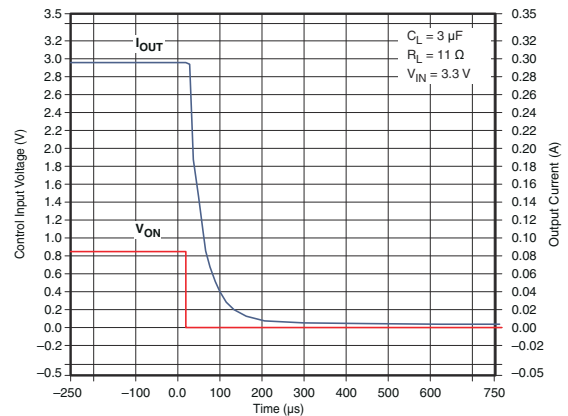

图 7-54. t_{OFF} Response

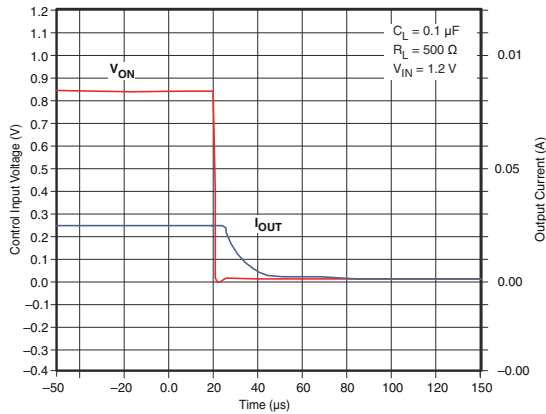

图 7-55. t_{OFF} Response

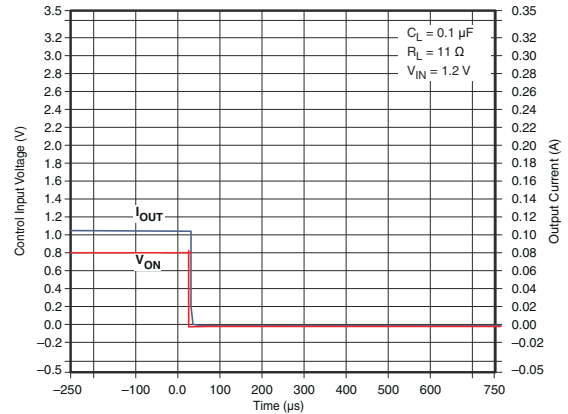

图 7-56. t_{OFF} Response

8 Parameter Measurement Information

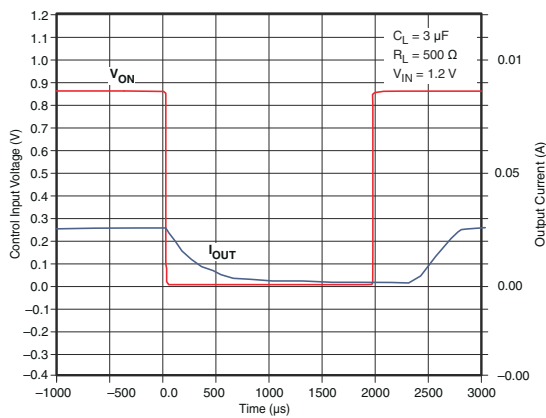

A. t_{rise} and t_{fall} of the control signal is 100 ns.

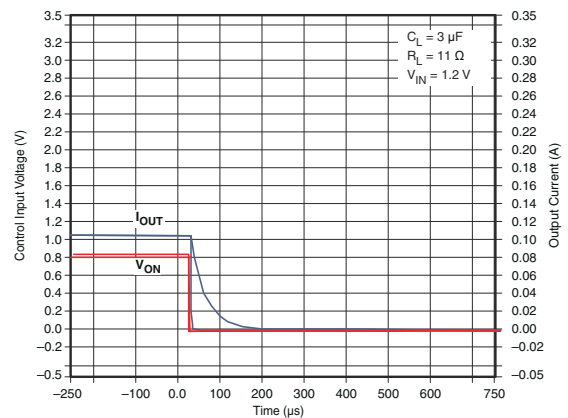
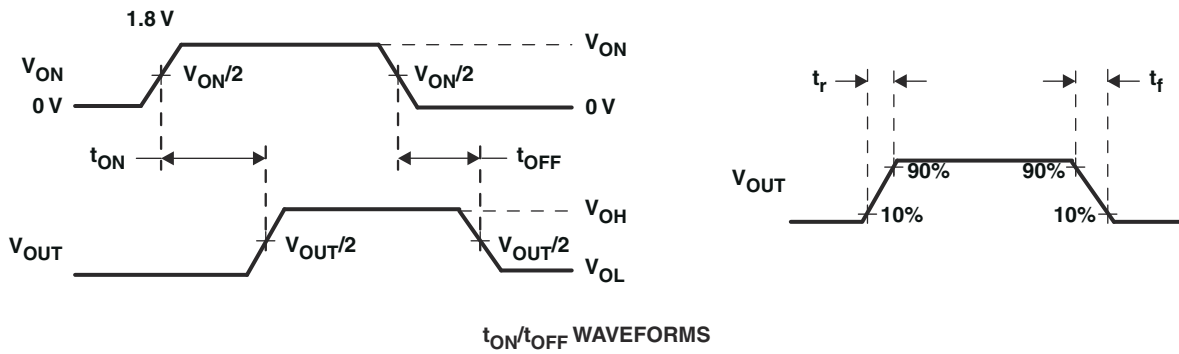
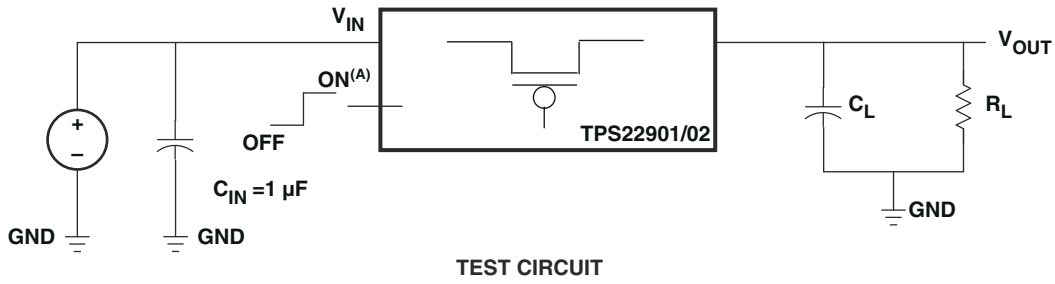
图 8-1. Test Circuit and t_{ON}/t_{OFF} Waveforms

9 Detailed Description

9.1 Overview

The TPS2290x and TPS22902B is a single channel, 500-mA load switch in a small, space-saving DSBGA-4 package. These devices implement a P-channel MOSFET to provide a low ON-resistance for a low voltage drop across the device. A controlled rise time is used in applications to limit the inrush current.

9.2 Functional Block Diagram

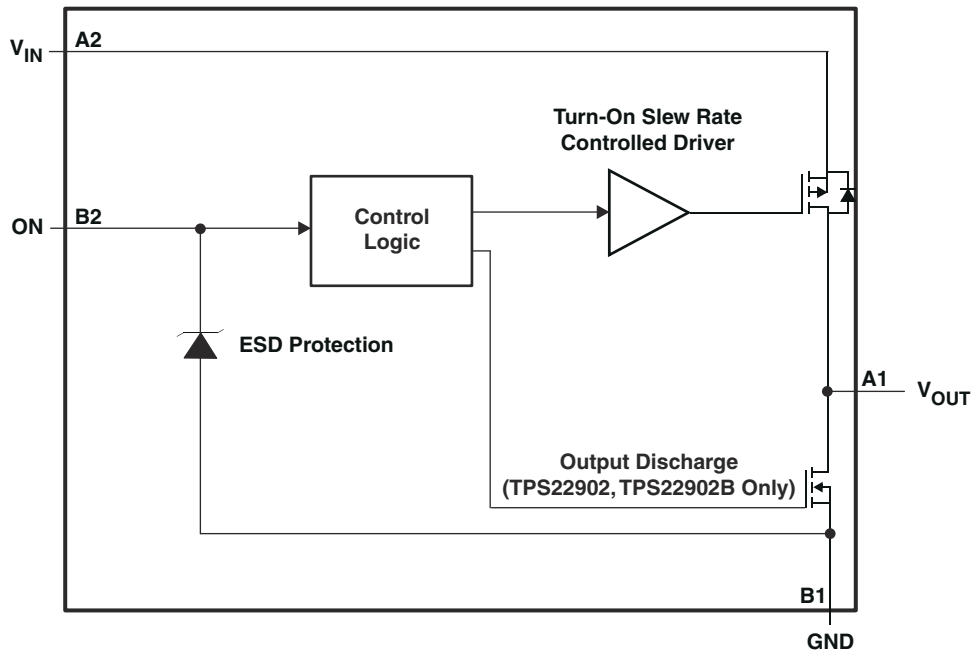

9.3 Feature Description

9.3.1 ON/OFF Control

The ON pin controls the state of the switch. Activating ON continuously holds the switch in the on state. ON is active-high and has a low threshold, making it capable of interfacing with low-voltage signals. The ON pin is compatible with standard GPIO logic threshold, and it can be used with any microcontroller with 1.2 V, 1.8 V, 2.5 V or 3.3 V GPIOs.

9.3.2 Quick Output Discharge

The TPS2290x and TPS22902B includes the Quick Output Discharge (QOD) feature. When the switch is disabled, a discharge resistance with a typical value of 88 Ω is connected between the output and ground. This resistance pulls down the output and prevents it from floating when the device is disabled.

9.4 Device Functional Modes

表 9-1 lists the VOUT pin connections for a particular device as determined by the ON pin.

Table 9-1. VOUT Function Table

ON (Control Input)	TPS22901	TPS22902/2B
L	Open	GND
H	VIN	VIN

10 Application and Implementation

Note

Information in the following applications sections is not part of the TI component specification, and TI does not warrant its accuracy or completeness. TI's customers are responsible for determining suitability of components for their purposes. Customers should validate and test their design implementation to confirm system functionality.

10.1 Application Information

10.1.1 Input Capacitor (Optional)

To limit the voltage drop on the input supply caused by transient inrush currents when the switch turns on into a discharged load capacitor, a capacitor needs to be placed between V_{IN} and GND. A 1- μF ceramic capacitor, C_{IN} , placed close to the pins is usually sufficient. Higher values of C_{IN} can be use to further reduce the voltage drop during high current application. When switching heavy loads, TI recommends using an input capacitor about 10 times higher than the output capacitor in order to avoid excessive voltage drop.

10.1.2 Output Capacitor (Optional)

Because of the integral body diode in the PMOS switch, a C_{IN} greater than C_L is highly recommended. A C_L greater than C_{IN} can cause V_{OUT} to exceed V_{IN} when the system supply is removed. This could result in current flow through the body diode from V_{OUT} to V_{IN} .

10.2 Typical Application

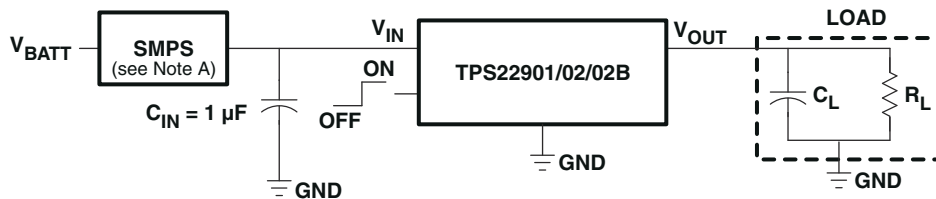

A. Switched-mode power supply

图 10-1. Typical Application Schematic

10.2.1 Design Requirements

Table 10-1. Design Parameters

DESIGN PARAMETER	EXAMPLE VALUE
V_{IN}	1.8 V
C_L	4.7 μF
Load current	500 mA
Ambient Temperature	25 °C
Maximum inrush current	200 mA

10.2.2 Detailed Design Procedure

10.2.2.1 Managing Inrush Current

When the switch is enabled, the output capacitors must be charged up from 0 V to the set value (1.8 V in this example). This charge arrives in the form of inrush current. Inrush current can be calculated using the following equation:

$$I_{\text{INRUSH}} = C_L \times \frac{dV_{\text{OUT}}}{dt} \quad (1)$$

where:

- C_L = Output capacitance
- dV_{OUT} = Output voltage
- dt = Rise time

The TPS2290x and TPS22902B offers a controlled rise time for minimizing inrush current. This device can be selected based upon the minimum acceptable rise time which can be calculated using the design requirements and the inrush current equation. An output capacitance of 4.7 μF will be used since the amount of inrush current increases with output capacitance:

$$\begin{aligned} 200 \text{ mA} &= 4.7 \mu\text{F} \times 1.8\text{V} / dt \\ dt &= 42.3 \mu\text{s} \end{aligned} \quad (2)$$

To ensure an inrush current of less than 200 mA, a device with a rise time greater than 42.3 μs must be used. The TPS22902B has a typical rise time of 220 μs at 1.8 V which meets the above design requirements. The TPS22901/2 has a faster rise time of 40 μs at 1.8 V, and this would result in an inrush current larger than desired.

10.2.2.2 VIN to VOUT Voltage Drop

The voltage drop from VIN to VOUT is determined by the ON-resistance of the device and the load current. R_{ON} can be found in [セクション 7.5](#) and is dependent on temperature. When the value of R_{ON} is found, the following equation can be used to calculate the voltage drop across the device:

$$\Delta V = I_{\text{LOAD}} \times R_{\text{ON}} \quad (3)$$

where:

- ΔV = Voltage drop across the device
- I_{LOAD} = Load current
- R_{ON} = ON-resistance of the device

At $V_{\text{IN}} = 1.8 \text{ V}$, the TPS22901/2/2B has an R_{ON} value of 109 m Ω . Using this value and the defined load current, the above equation can be evaluated:

$$\begin{aligned} \Delta V &= 500 \text{ mA} \times 109 \text{ m}\Omega \\ \Delta V &= 54.5 \text{ mV} \end{aligned} \quad (4)$$

Therefore, the voltage drop across the device will be 54.5 mV.

10.2.3 Application Curve

 10-2 shows the expected voltage drop across the device for different load currents and input voltages.

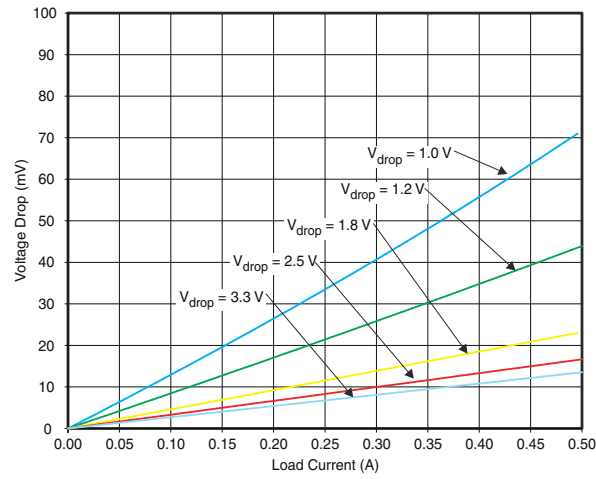

 10-2. Voltage Drop vs Load Current

11 Power Supply Recommendations

The device is designed to operate with a V_{IN} range of 1 V to 3.6 V. This supply must be well regulated and placed as close to the device terminals as possible. It must also be able to withstand all transient and load currents, using a recommended input capacitance of 1 μF if necessary. If the supply is located more than a few inches from the device terminals, additional bulk capacitance may be required in addition to the ceramic bypass capacitors. If additional bulk capacitance is required, an electrolytic, tantalum, or ceramic capacitor of 10 μF may be sufficient.

12 Layout

12.1 Layout Guidelines

For best performance, V_{IN} , V_{OUT} , and GND traces should be as short and wide as possible to help minimize the parasitic electrical effects. To be most effective, the input and output capacitors should be placed close to the device to minimize the effects that parasitic trace inductances may have on normal operation.

For higher reliability, the maximum IC junction temperature, $T_{J(\text{max})}$, should be restricted to 125°C under normal operating conditions. Junction temperature is directly proportional to power dissipation in the device and the two are related by

$$T_J = T_A + \theta_{JA} \times P_D \quad (5)$$

where:

- T_J = Junction temperature of the device
- T_A = Ambient temperature
- P_D = Power dissipation inside the device
- θ_{JA} = Junction to ambient thermal resistance. See Thermal Information section of the datasheet. This parameter is highly dependent on board layout.

12.2 Layout Example

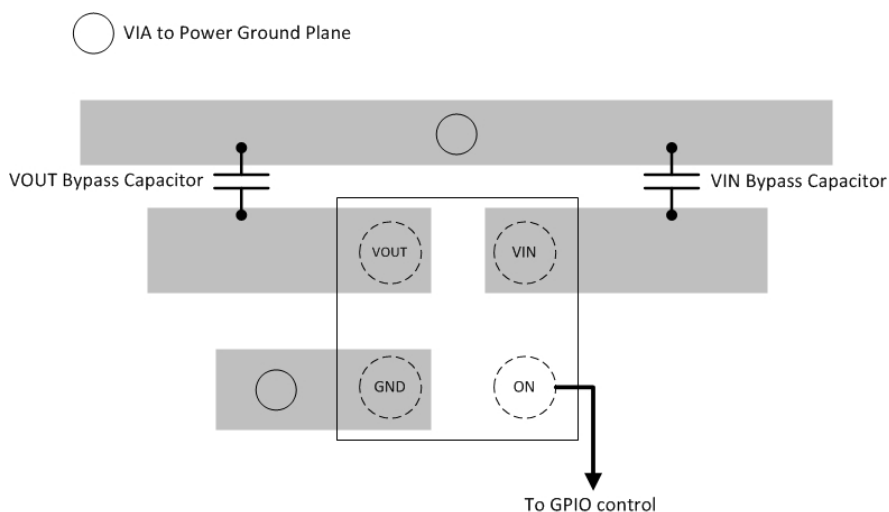

12-1. Layout Example Schematic

13 Device and Documentation Support

13.1 Related Links

The table below lists quick access links. Categories include technical documents, support and community resources, tools and software, and quick access to sample or buy.

Table 13-1. Related Links

PARTS	PRODUCT FOLDER	SAMPLE & BUY	TECHNICAL DOCUMENTS	TOOLS & SOFTWARE	SUPPORT & COMMUNITY
TPS22901	Click here	Click here	Click here	Click here	Click here
TPS22902	Click here	Click here	Click here	Click here	Click here
TPS22902B	Click here	Click here	Click here	Click here	Click here

13.2 Trademarks

すべての商標は、それぞれの所有者に帰属します。

13.3 Electrostatic Discharge Caution



This integrated circuit can be damaged by ESD. Texas Instruments recommends that all integrated circuits be handled with appropriate precautions. Failure to observe proper handling and installation procedures can cause damage.

ESD damage can range from subtle performance degradation to complete device failure. Precision integrated circuits may be more susceptible to damage because very small parametric changes could cause the device not to meet its published specifications.



13.4 Glossary

TI Glossary This glossary lists and explains terms, acronyms, and definitions.

14 Mechanical, Packaging, and Orderable Information

The following pages include mechanical, packaging, and orderable information. This information is the most current data available for the designated devices. This data is subject to change without notice and revision of this document. For browser-based versions of this data sheet, refer to the left-hand navigation.

PACKAGING INFORMATION

Orderable Device	Status (1)	Package Type	Package Drawing	Pins	Package Qty	Eco Plan (2)	Lead finish/ Ball material (6)	MSL Peak Temp (3)	Op Temp (°C)	Device Marking (4/5)	Samples
TPS22901YFPR	ACTIVE	DSBGA	YFP	4	3000	RoHS & Green	SNAGCU	Level-1-260C-UNLIM	-40 to 85	3P (3, 5)	
TPS22902BYFPR	ACTIVE	DSBGA	YFP	4	3000	RoHS & Green	SNAGCU	Level-1-260C-UNLIM	-40 to 85	3S 3	
TPS22902YFPR	ACTIVE	DSBGA	YFP	4	3000	RoHS & Green	SNAGCU	Level-1-260C-UNLIM	-40 to 85	3R	

(1) The marketing status values are defined as follows:

ACTIVE: Product device recommended for new designs.

LIFEBUY: TI has announced that the device will be discontinued, and a lifetime-buy period is in effect.

NRND: Not recommended for new designs. Device is in production to support existing customers, but TI does not recommend using this part in a new design.

PREVIEW: Device has been announced but is not in production. Samples may or may not be available.

OBSOLETE: TI has discontinued the production of the device.

(2) **RoHS:** TI defines "RoHS" to mean semiconductor products that are compliant with the current EU RoHS requirements for all 10 RoHS substances, including the requirement that RoHS substance do not exceed 0.1% by weight in homogeneous materials. Where designed to be soldered at high temperatures, "RoHS" products are suitable for use in specified lead-free processes. TI may reference these types of products as "Pb-Free".

RoHS Exempt: TI defines "RoHS Exempt" to mean products that contain lead but are compliant with EU RoHS pursuant to a specific EU RoHS exemption.

Green: TI defines "Green" to mean the content of Chlorine (Cl) and Bromine (Br) based flame retardants meet JS709B low halogen requirements of <=1000ppm threshold. Antimony trioxide based flame retardants must also meet the <=1000ppm threshold requirement.

(3) MSL, Peak Temp. - The Moisture Sensitivity Level rating according to the JEDEC industry standard classifications, and peak solder temperature.

(4) There may be additional marking, which relates to the logo, the lot trace code information, or the environmental category on the device.

(5) Multiple Device Markings will be inside parentheses. Only one Device Marking contained in parentheses and separated by a "-" will appear on a device. If a line is indented then it is a continuation of the previous line and the two combined represent the entire Device Marking for that device.

(6) Lead finish/Ball material - Orderable Devices may have multiple material finish options. Finish options are separated by a vertical ruled line. Lead finish/Ball material values may wrap to two lines if the finish value exceeds the maximum column width.

Important Information and Disclaimer:The information provided on this page represents TI's knowledge and belief as of the date that it is provided. TI bases its knowledge and belief on information provided by third parties, and makes no representation or warranty as to the accuracy of such information. Efforts are underway to better integrate information from third parties. TI has taken and continues to take reasonable steps to provide representative and accurate information but may not have conducted destructive testing or chemical analysis on incoming materials and chemicals. TI and TI suppliers consider certain information to be proprietary, and thus CAS numbers and other limited information may not be available for release.

In no event shall TI's liability arising out of such information exceed the total purchase price of the TI part(s) at issue in this document sold by TI to Customer on an annual basis.

TAPE AND REEL INFORMATION

QUADRANT ASSIGNMENTS FOR PIN 1 ORIENTATION IN TAPE



*All dimensions are nominal

Device	Package Type	Package Drawing	Pins	SPQ	Reel Diameter (mm)	Reel Width W1 (mm)	A0 (mm)	B0 (mm)	K0 (mm)	P1 (mm)	W (mm)	Pin1 Quadrant
TPS22901YFPR	DSBGA	YFP	4	3000	178.0	9.2	0.89	0.89	0.58	4.0	8.0	Q1
TPS22902BYFPR	DSBGA	YFP	4	3000	180.0	8.4	0.89	0.89	0.58	4.0	8.0	Q1
TPS22902YFPR	DSBGA	YFP	4	3000	180.0	8.4	0.89	0.89	0.58	4.0	8.0	Q1

TAPE AND REEL BOX DIMENSIONS

*All dimensions are nominal

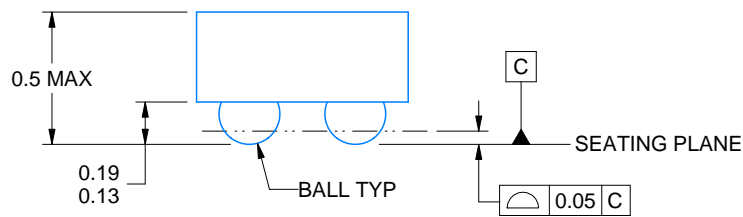
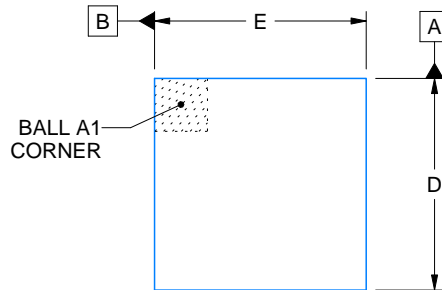
Device	Package Type	Package Drawing	Pins	SPQ	Length (mm)	Width (mm)	Height (mm)
TPS22901YFPR	DSBGA	YFP	4	3000	220.0	220.0	35.0
TPS22902BYFPR	DSBGA	YFP	4	3000	182.0	182.0	20.0
TPS22902YFPR	DSBGA	YFP	4	3000	182.0	182.0	20.0



D: Max = 0.79 mm, Min = 0.73 mm
 E: Max = 0.79 mm, Min = 0.73 mm

4223507/A 01/2017

NOTES:

1. All linear dimensions are in millimeters. Any dimensions in parenthesis are for reference only. Dimensioning and tolerancing per ASME Y14.5M.
2. This drawing is subject to change without notice.

EXAMPLE BOARD LAYOUT

YFP0004

DSBGA - 0.5 mm max height

DIE SIZE BALL GRID ARRAY



LAND PATTERN EXAMPLE
EXPOSED METAL SHOWN
SCALE:50X

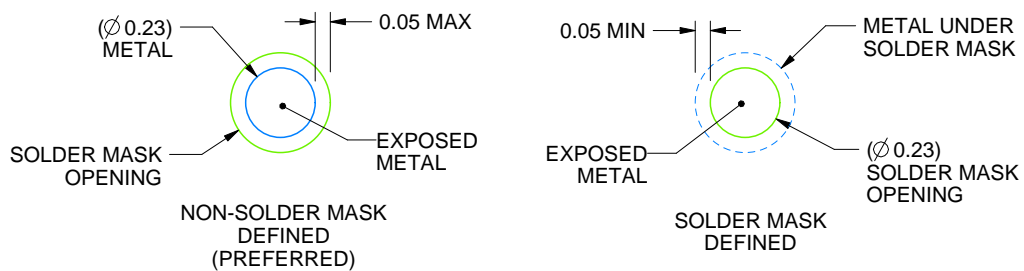

SOLDER MASK DETAILS
NOT TO SCALE

4223507/A 01/2017

NOTES: (continued)

- Final dimensions may vary due to manufacturing tolerance considerations and also routing constraints. For more information, see Texas Instruments literature number SNVA009 (www.ti.com/lit/snva009).

EXAMPLE STENCIL DESIGN

YFP0004

DSBGA - 0.5 mm max height

DIE SIZE BALL GRID ARRAY

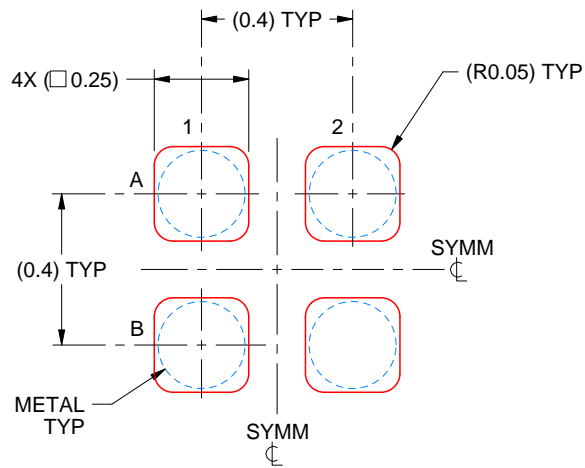

SOLDER PASTE EXAMPLE
BASED ON 0.1 mm THICK STENCIL
SCALE:50X

4223507/A 01/2017

NOTES: (continued)

4. Laser cutting apertures with trapezoidal walls and rounded corners may offer better paste release.

重要なお知らせと免責事項

TI は、技術データと信頼性データ (データシートを含みます)、設計リソース (リファレンス・デザインを含みます)、アプリケーションや設計に関する各種アドバイス、Web ツール、安全性情報、その他のリソースを、欠陥が存在する可能性のある「現状のまま」提供しており、商品性および特定目的に対する適合性の黙示保証、第三者の知的財産権の非侵害保証を含むいかなる保証も、明示的または黙示的にかかわらず拒否します。

これらのリソースは、TI 製品を使用する設計の経験を積んだ開発者への提供を意図したものです。(1) お客様のアプリケーションに適した TI 製品の選定、(2) お客様のアプリケーションの設計、検証、試験、(3) お客様のアプリケーションに該当する各種規格や、その他のあらゆる安全性、セキュリティ、規制、または他の要件への確実な適合に関する責任を、お客様のみが単独で負うものとし、

上記の各種リソースは、予告なく変更される可能性があります。これらのリソースは、リソースで説明されている TI 製品を使用するアプリケーションの開発の目的でのみ、TI はその使用をお客様に許諾します。これらのリソースに関して、他の目的で複製することや掲載することは禁止されています。TI や第三者の知的財産権のライセンスが付与されている訳ではありません。お客様は、これらのリソースを自身で使用した結果発生するあらゆる申し立て、損害、費用、損失、責任について、TI およびその代理人を完全に補償するものとし、TI は一切の責任を拒否します。

TI の製品は、[TI の販売条件](#)、または [ti.com](#) やかかる TI 製品の関連資料などのいずれかを通じて提供する適用可能な条項の下で提供されています。TI がこれらのリソースを提供することは、適用される TI の保証または他の保証の放棄の拡大や変更を意味するものではありません。

お客様がいかなる追加条項または代替条項を提案した場合でも、TI はそれらに異議を唱え、拒否します。

郵送先住所 : Texas Instruments, Post Office Box 655303, Dallas, Texas 75265
Copyright © 2024, Texas Instruments Incorporated