

TPD1E10B09-Q1 車載対応 1 チャネル ESD、0402 パッケージ、10pF 容量、9V ブレークダウン

1 特長

- AEC-Q101 準拠
- IEC 61000-4-2 レベル 4 ESD 保護
 - 接触放電 $\pm 20\text{kV}$
 - 空中放電 $\pm 20\text{kV}$
- ISO 10605 (330pF, 330 Ω) ESD 保護
 - 接触放電 $\pm 8\text{kV}$
 - 空中放電 $\pm 15\text{kV}$
- IEC 61000-4-5 サージ保護
 - 4.5A (8/20 μs)
- I/O 容量: 10pF (標準値)
- R_{DYN} : 0.5 Ω (代表値)
- DC ブレークダウン電圧: $\pm 9.5\text{V}$ (最小値)
- 超低リーク電流: 100nA (最大値)
- 13V のクランプ電圧 ($I_{\text{PP}} = 1\text{A}$ での標準値)
- 産業用温度範囲: $-40^{\circ}\text{C} \sim +125^{\circ}\text{C}$
- 省スペースの 0402 パッケージ

2 アプリケーション

- 最終製品
 - ヘッド・ユニット
 - プレミアム・オーディオ
 - 外部アンプ
 - ボディ・コントロール・モジュール
 - ゲートウェイ
 - テレマティクス
 - カメラ・モジュール
- インターフェイス
 - オーディオ・ライン
 - 押しボタン
 - メモリ・インターフェイス
 - GPIO

3 概要

TPD1E10B09-Q1 デバイスは、小型の 0402 業界標準パッケージで提供される双方向の静電気放電 (ESD) 過渡電圧抑制 (TVS) ダイオードです。この TVS 保護ダイオードは、容積の制約が厳しいアプリケーションでの部品配置用に便利で、低い R_{DYN} と、高い IEC 定格が特長です。TPD1E10B09-Q1 は、IEC 61000-4-2 国際標準 (レベル 4) で規定されている最大レベルを超える ESD 衝撃を放散できる定格で、 $\pm 20\text{kV}$ の接触放電と、 $\pm 20\text{kV}$ の IEC エアギャップ保護を実現しています。ESD 電圧は容易に 5kV に達することがあり、極端な状況ではこの電圧がさらに高くなる可能性もあり、多くの IC に損傷を引き起こします。たとえば、湿度の低い環境では電圧が 20kV を超えることがあります。

低い動的抵抗 (0.5 Ω) と、低いクランプ電圧 (1A IPP で 13V) により、過渡事象に対するシステム・レベルの保護が可能で、ESD 事象にさらされる設計において強固な保護を実現できます。また、このデバイスは IO 容量が 10pF であるため、オーディオ・ライン、プッシュボタン、メモリ・インターフェイス、GPIO に最適です。

このデバイスには、車載用認定なしのバージョンもありません。TPD1E10B09

パッケージ情報

部品番号	パッケージ(1)	パッケージ・サイズ (2)
TPD1E10B09-Q1	DPY (X1SON, 2)	1mm × 0.6mm

- (1) 利用可能なすべてのパッケージについては、データシートの末尾にある注文情報を参照してください。
- (2) パッケージ・サイズ (長さ×幅) は公称値であり、該当する場合はピンも含まれます。

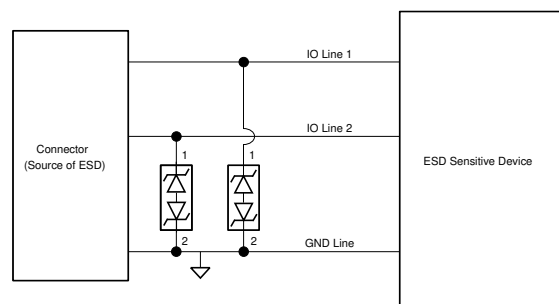

Copyright © 2016, Texas Instruments Incorporated

アプリケーション回路図



Table of Contents

1 特長	1	7.3 Feature Description.....	8
2 アプリケーション	1	7.4 Device Functional Modes.....	9
3 概要	1	8 Application and Implementation	10
4 Revision History	2	8.1 Application Information.....	10
5 Pin Configuration and Functions	3	8.2 Typical Application.....	10
6 Specifications	4	8.3 Power Supply Recommendations.....	12
6.1 Absolute Maximum Ratings.....	4	8.4 Layout.....	12
6.2 ESD Ratings—AEC Specification.....	4	9 Device and Documentation Support	13
6.3 ESD Ratings—IEC Specification.....	4	9.1 Documentation Support.....	13
6.4 ESD Ratings—ISO Specification.....	4	9.2 ドキュメントの更新通知を受け取る方法.....	13
6.5 Recommended Operating Conditions.....	4	9.3 サポート・リソース.....	13
6.6 Thermal Information.....	5	9.4 Trademarks.....	13
6.7 Electrical Characteristics.....	5	9.5 静電気放電に関する注意事項.....	13
6.8 Typical Characteristics.....	6	9.6 用語集.....	13
7 Detailed Description	8	10 Mechanical, Packaging, and Orderable Information	13
7.1 Overview.....	8		
7.2 Functional Block Diagram.....	8		

4 Revision History

資料番号末尾の英字は改訂を表しています。その改訂履歴は英語版に準じています。

Changes from Revision A (September 2016) to Revision B (September 2023) Page

- 「パッケージ情報」表のフォーマットを変更し、パッケージのリード・サイズを追加 1
- ドキュメント全体にわたって表、図、相互参照の採番方法を変更..... 1

Changes from Revision * (August 2016) to Revision A (September 2016) Page

- デバイスのステータスを「製品プレビュー」から「量産データ」へ変更 1

5 Pin Configuration and Functions

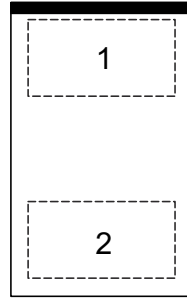

5-1. DPY Package, 2-Pin X1SON (Top View)

表 5-1. Pin Functions

PIN		TYPE ⁽¹⁾	DESCRIPTION
NO.	NAME		
1	IO	I/O	ESD protected I/O
2	GND	Ground	Ground. Connect to ground

(1) I = input, O = output, GND = ground

6 Specifications

6.1 Absolute Maximum Ratings

over operating free-air temperature range (unless otherwise noted)⁽¹⁾

	MIN	MAX	UNIT
I _{PP} Peak pulse current (tp = 8/20 μs, positive)		5.5	A
I _{PP} Peak pulse current (tp = 8/20 μs, negative)		4.5	A
P _{PP} Peak pulse power (tp = 8/20 μs)		90	W
P Power Dissipation ⁽²⁾		162	mW
Operating temperature	−40	125	°C
T _{stg} Storage temperature	−65	155	°C

- (1) Stresses beyond those listed under *Absolute Maximum Ratings* may cause permanent damage to the device. These are stress ratings only, which do not imply functional operation of the device at these or any other conditions beyond those indicated under *Recommended Operating Conditions*. Exposure to absolute-maximum-rated conditions for extended periods may affect device reliability.
- (2) Max junction temperature: 125°C; power dissipation calculated at 25°C ambient temperature using JEDEC High K board Standard. Not to be used for steady state power dissipation in the breakdown region.

6.2 ESD Ratings—AEC Specification

	VALUE	UNIT
V _(ESD) Electrostatic discharge	Human-body model (HBM), per AEC Q100-002 ⁽¹⁾	±2500
	Charged-device model (CDM), per AEC Q100-011	±1000

- (1) AEC Q100-002 indicates that HBM stressing shall be in accordance with the ANSI/ESDA/JEDEC JS-001 specification.

6.3 ESD Ratings—IEC Specification

	VALUE	UNIT
V _(ESD) Electrostatic discharge	IEC 61000-4-2 Contact Discharge	±20000
	IEC 61000-4-2 Air-Gap Discharge	±20000

6.4 ESD Ratings—ISO Specification

	VALUE	UNIT
V _(ESD) Electrostatic discharge	ISO 10605 (330 pF, 330 Ω) Contact Discharge	±8000
	ISO 10605 (330 pF, 330 Ω) Air-Gap Discharge	±15000

6.5 Recommended Operating Conditions

over operating free-air temperature range (unless otherwise noted)

	MIN	MAX	UNIT
T _A Operating free-air temperature	−40	125	°C
Operating voltage	−9	9	V

6.6 Thermal Information

THERMAL METRIC ⁽¹⁾		TPD1E10B09-Q1	
		DPY (X1SON)	
		2 PINS	
			UNIT
R _{θJA}	Junction-to-ambient thermal resistance	615.5	°C/W
R _{θJC(top)}	Junction-to-case (top) thermal resistance	404.8	°C/W
R _{θJB}	Junction-to-board thermal resistance	493.3	°C/W
ψ _{JT}	Junction-to-top characterization parameter	127.7	°C/W
ψ _{JB}	Junction-to-board characterization parameter	493.3	°C/W

(1) For more information about traditional and new thermal metrics, see the [Semiconductor and IC Package Thermal Metrics](#) application report.

6.7 Electrical Characteristics

over operating free-air temperature range (unless otherwise noted)

PARAMETER		TEST CONDITION	MIN	TYP	MAX	UNIT
V _{RWM}	Reverse stand-off voltage	Pin 1 to 2 or pin 2 to 1			9	V
I _{LEAK}	Leakage current	Pin 1 = 5 V, pin 2 = 0 V			100	nA
V _{Clamp1,2}	Clamp voltage with ESD strike on pin 1, pin 2 grounded	I _{PP} = 1 A, t _p = 8/20 μs ⁽²⁾		13		V
		I _{PP} = 5 A, t _p = 8/20 μs ⁽²⁾		17		
V _{Clamp2,1}	Clamp voltage with ESD strike on pin 2, pin 1 grounded	I _{PP} = 1 A, t _p = 8/20 μs ⁽²⁾		13		V
		I _{PP} = 4.5 A, t _p = 8/20 μs ⁽²⁾		20		
R _{DYN}	Dynamic resistance	Pin 1 to pin 2 ⁽¹⁾		0.5		Ω
		Pin 2 to pin 1 ⁽¹⁾		0.5		
C _{IO}	I/O capacitance	V _{IO} = 2.5 V; f = 1 MHz		10		pF
V _{BR1,2}	Break-down voltage, pin 1 to pin 2	I _{IO} = 1 mA	9.5			V
V _{BR2,1}	Break-down voltage, pin 2 to pin 1	I _{IO} = 1 mA	9.5			V

(1) Extraction of R_{DYN} using least squares fit of TLP characteristics from I_{PP} = 10 A to I_{PP} = 20 A.

(2) Non-repetitive current pulse 8/20 μs exponentially decaying waveform according to IEC 61000-4-5.

6.8 Typical Characteristics

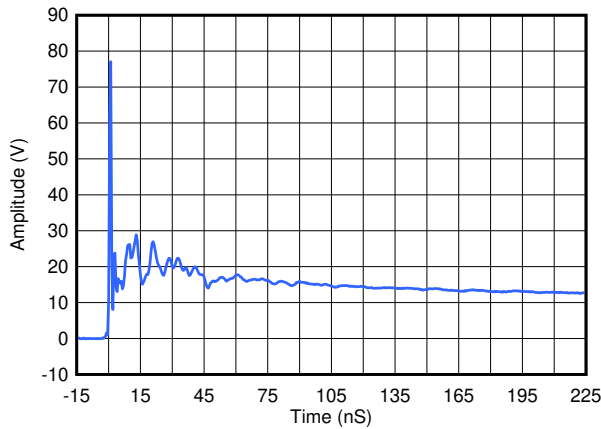

6-1. ESD Clamp Voltage 8-kV Contact ESD

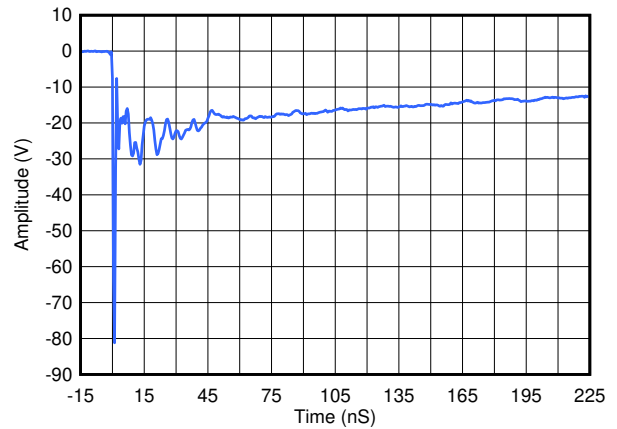

6-2. ESD Clamp Voltage -8-kV Contact ESD

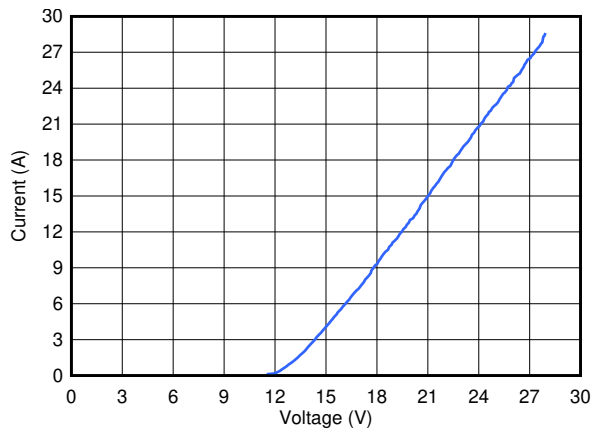

6-3. Transmission Line Pulse (TLP) Waveform Pin 1 to Pin 2

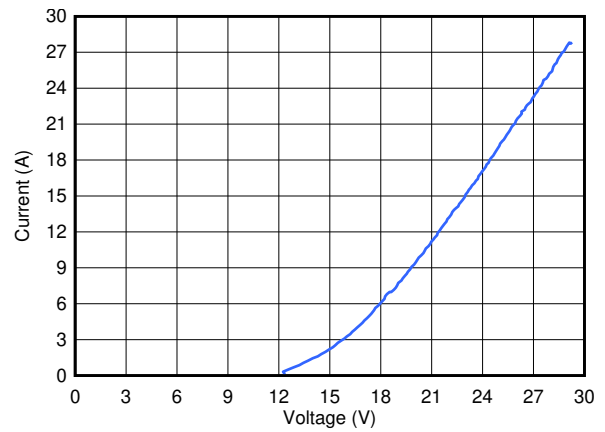

6-4. Transmission Line Pulse (TLP) Waveform Pin 2 to Pin 1

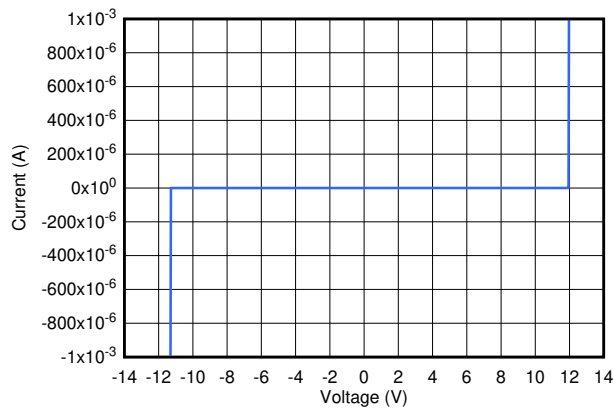

6-5. IV Curve

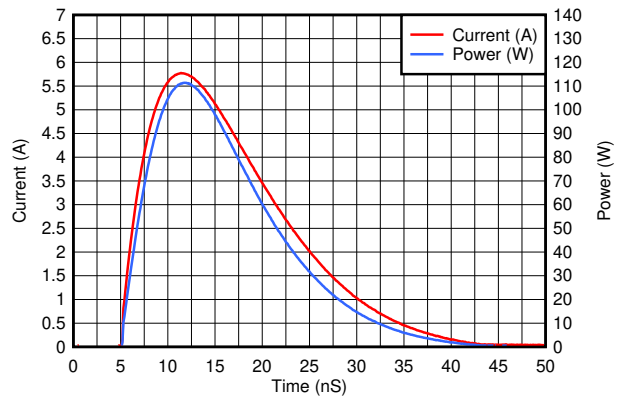

6-6. Positive Surge Waveform 8/20 μ s

6.8 Typical Characteristics (continued)

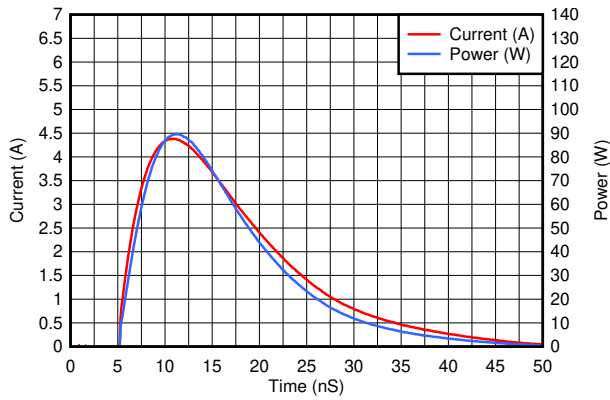

6-7. Negative Surge Waveform 8/20 μ s

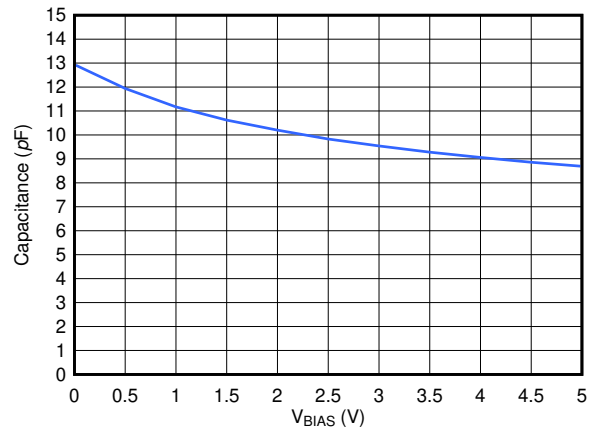

6-8. Pin Capacitance Across V_{BIAS}

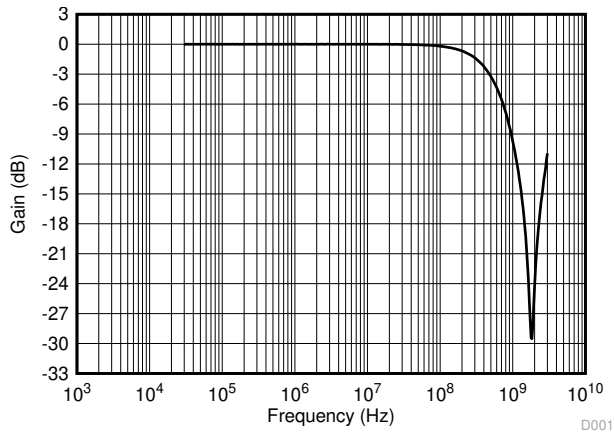

6-9. Insertion Loss

7 Detailed Description

7.1 Overview

The TPD1E10B09-Q1 is a single-channel ESD TVS that provides ± 20 -kV IEC 61000-4-2 (Level 4) contact and air-gap ESD protection. The 10-pF back-to-back diode architecture is suitable for signals that range from -9 V to 9 V and supports data rates up to 500 Mbps. The industry-standard 0402 package is convenient for placement in applications with limited space.

7.2 Functional Block Diagram

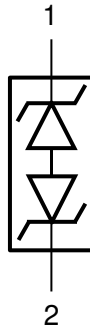

Copyright © 2016, Texas Instruments Incorporated

7.3 Feature Description

The TPD1E10B09-Q1 is a bidirectional TVS with high ESD protection level. This device protects circuit from ESD strikes up to ± 20 -kV contact and ± 20 -kV air-gap specified in the IEC 61000-4-2 level 4 international standard. The device can also handle up to 4.5-A surge current (IEC 61000-4-5 8/20 μ s). The I/O capacitance of 10 pF supports a data rate up to 500 Mbps. This clamping device has a small dynamic resistance of 0.5Ω typically. This makes the clamping voltage low when the device is actively protecting other circuits. For example, the clamping voltage is only 13 V when the device is taking 1-A transient current. The breakdown is bidirectional so that this protection device is a good fit for GPIO, especially audio lines which carry bidirectional signals. Low leakage allows the diode to conserve power when working below the V_{RWM} . The industrial temperature range of -40°C to $+125^\circ\text{C}$ makes this ESD device work at extensive temperatures in most environments. The space-saving 0402 package can fit into small electronic devices like mobile equipment and wearables.

7.3.1 AEC-Q101 Qualified

This device is qualified to AEC-Q101 standards and is qualified to operate from -40°C to $+125^\circ\text{C}$.

7.3.2 IEC 61000-4-2 ESD Protection

The I/O pins can withstand ESD events up to ± 20 -kV contact and ± 20 -kV air according to the IEC 61000-4-2 standard. An ESD-surge clamp diverts the current to ground.

7.3.3 ISO 10605 ESD Protection

The I/O pins can withstand ESD events at least ± 8 -kV contact and ± 15 -kV air according to the ISO 10605 (330 pF, 330 Ω) standard. An ESD-surge clamp diverts the current to ground.

7.3.4 IEC 61000-4-5 Surge Protection

The IO pins can withstand surge events up to 5.5 A positive and 4.5 A negative (8/20 μ s waveform). An ESD-surge clamp diverts this current to ground.

7.3.5 IO Capacitance

The capacitance between the I/O pins 10 pF. This capacitance support data rates up to 500 Mbps.

7.3.6 Dynamic Resistance

The IO pins feature an ESD clamp that has a low R_{DYN} of 0.50 Ω which prevents system damage during ESD events.

7.3.7 DC Breakdown Voltage

The DC breakdown voltage between the IO pins is a minimum of 9.5 V, which protects sensitive equipment from surges above the reverse standoff voltage of 9 V.

7.3.8 Ultra Low Leakage Current

The IO pins feature an ultra-low leakage current of 100 nA (maximum) with a bias of 5 V.

7.3.9 Clamping Voltage

The IO pins feature an ESD clamp that is capable of clamping the voltage to 13 V ($I_{PP} = 1$ A) and 17 V ($I_{PP} = 5$ A).

7.3.10 Industrial Temperature Range

This device features an industrial operating range of -40°C to $+125^{\circ}\text{C}$.

7.3.11 Space-Saving Footprint

This device features a space-saving, industry standard 0402 footprint.

7.4 Device Functional Modes

The TPD1E10B09-Q1 is a passive clamp that has low leakage during normal operation when the voltage between pin 1 and pin 2 is below V_{RWM} and activates when the voltage between pin 1 and pin 2 goes above V_{BR} . During IEC ESD events, transient voltages as high as ± 20 kV can be clamped between the two pins. When the voltages on the protected lines fall below the trigger voltage, the device reverts back to the low leakage passive state.

8 Application and Implementation

注

以下のアプリケーション情報は、TI の製品仕様に含まれるものではなく、TI ではその正確性または完全性を保証いたしません。個々の目的に対する製品の適合性については、お客様の責任で判断していただくこととなります。お客様は自身の設計実装を検証しテストすることで、システムの機能を確認する必要があります。

8.1 Application Information

The TPD1E10B09-Q1 is a single-channel back-to-back diode that protects one bidirectional signal line from electrostatic discharge and surge pulses. Because the diode is bidirectional, the TPD1E10B09-Q1 protects signals that have positive or negative polarity. During normal operation, the diode behaves as a 10-pF capacitance to ground. Board layout is critical for optimal performance of any diode.

Placement: The diode must be placed very close to the external connector for optimal performance. Ideally, the diode must be placed on the line that it is protecting.

Layout: Pin 1 of the diode must be right over the protected signal line. There must a thick and short trace from pin 2 to ground. An example is shown in the [Layout](#) section.

8.2 Typical Application

A system with a human interface is vulnerable to large system-level ESD strikes that standard ICs cannot survive. TVS ESD protection diodes are typically used to suppress ESD at these connectors. The TPD1E10B09-Q1 is a single-channel ESD protection device containing back-to-back TVS diodes, which is typically used to provide a path to ground for dissipating ESD events on bidirectional signal lines between a human interface connector and a system. As the current from ESD passes through the device, only a small voltage drop is present across the diode structure. This is the voltage presented to the protected IC. The low R_{DYN} of the triggered TVS holds this voltage, V_{CLAMP} , to a tolerable level to the protected IC.

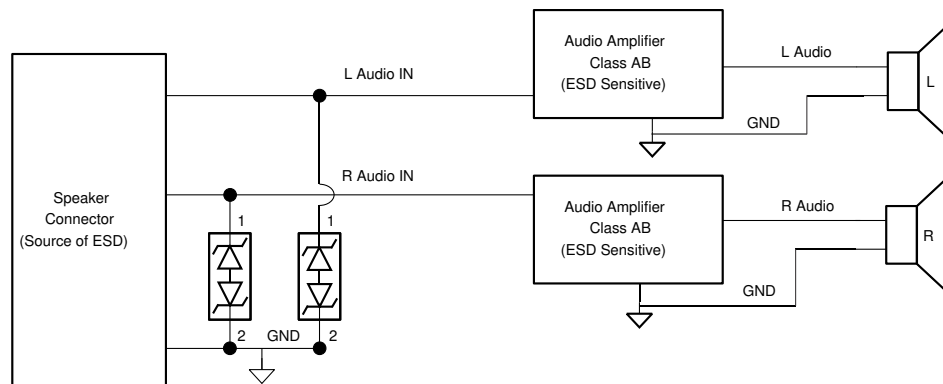

Copyright © 2016, Texas Instruments Incorporated

8-1. Typical Application Schematic

8.2.1 Design Requirements

For this design example, two TPD1E10B09-Q1s are used to protect left and right audio channels. 表 8-1 lists the known system parameters for this audio application.

表 8-1. Design Parameters

DESIGN PARAMETER	VALUE
Audio amplifier class	AB
Audio signal voltage range	-8 V to 8 V
Audio frequency content	20 Hz to 20 kHz
Required IEC 61000-4-2 ESD protection	±15-kV Contact, ±15-kV Air-Gap

8.2.2 Detailed Design Procedure

To begin the design process, some parameters must be decided upon; the designer must make sure:

- The voltage range on the protected line does not exceed the reverse standoff voltage of the TVS diode(s) (V_{RWM}).
- The operating frequency is supported by the I/O capacitance, C_{IO} , of the TVS diode.
- The IEC 61000-4-2 protection requirement is covered by the IEC performance of the TVS diode.

For this application, the audio signal voltage range is -8 V to 8 V. The V_{RWM} for the TVS is -9.5 V to 9.5 V; therefore, the bidirectional TVS does not break down during normal operation, and normal operation of the audio signal is not affected due to the signal voltage range. In this application, a bidirectional TVS like the TPD1E10B09-Q1 is required.

Next, consider the frequency content of this audio signal. In this application with the class AB amplifier, the frequency content is from 20 Hz to 20 kHz; ensure that the TVS I/O capacitance does not distort this signal by filtering it. With the TPD1E10B09-Q1 typical capacitance of 10 pF, which leads to a typical cutoff frequency of just under 500 MHz, this diode has sufficient bandwidth to pass the audio signal without distorting it.

Finally, the human interface in this application requires protection for ±15-kV Contact and ±15-kV Air-Gap ESD, which is above the standard Level 4 IEC 61000-4-2 system-level ESD protection. A standard TVS cannot survive this level of IEC ESD stress. However, the TPD1E10B09-Q1 can survive at least ±20-kV Contact and ±20-kV Air-Gap ESD. Therefore, the device can provide sufficient ESD protection for the interface, even though the requirements are stringent. For any TVS diode to provide its full range of ESD protection capabilities, as well as to minimize the noise and EMI disturbances the board will see during ESD events, it is crucial that a system designer uses proper board layout of their TVS ESD protection diodes. See the [Layout](#) section for instructions on properly laying out the TPD1E10B09-Q1.

8.2.3 Application Curves

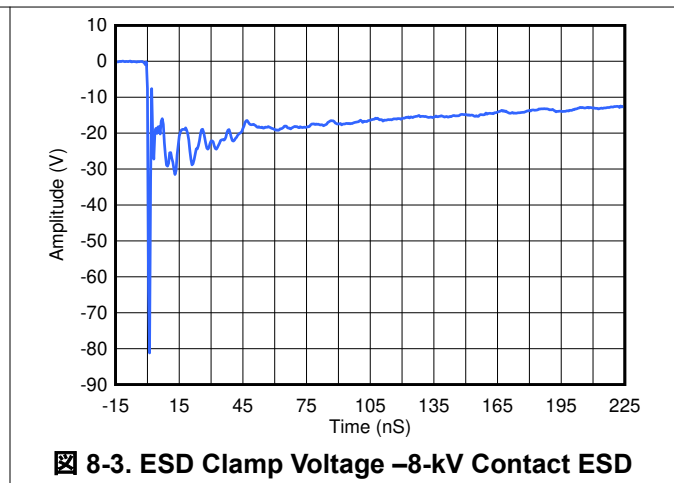
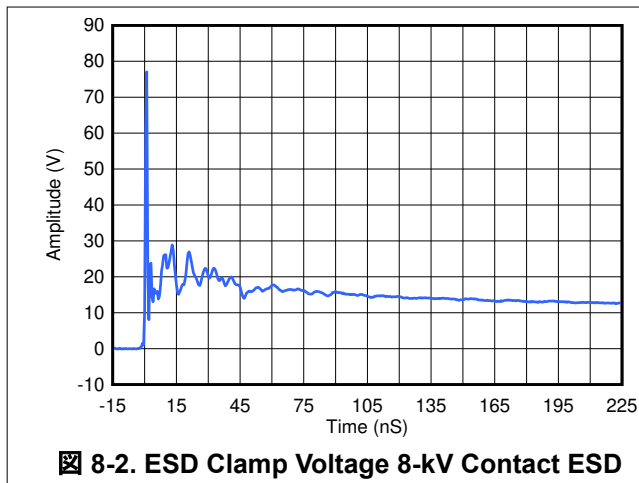

8.3 Power Supply Recommendations

This device is a passive TVS diode-based ESD protection device, so there is no need to power it. Do not violate the maximum specifications for each pin.

8.4 Layout

8.4.1 Layout Guidelines

- The optimum placement is as close to the connector as possible.
 - EMI during an ESD event can couple from the trace being struck to other nearby unprotected traces, resulting in early system failures.
 - The PCB designer must minimize the possibility of EMI coupling by keeping any unprotected traces away from the protected traces which are between the TVS and the connector.
- Route the protected traces as straight as possible.
- Use rounded corners with the largest radii possible on the protected traces between the TVS and the connector, thus eliminating any sharp corners.
 - Electric fields tend to build up on corners, increasing EMI coupling.
- If pin 1 or pin 2 is connected to ground, use a thick and short trace for this return path.

8.4.2 Layout Example

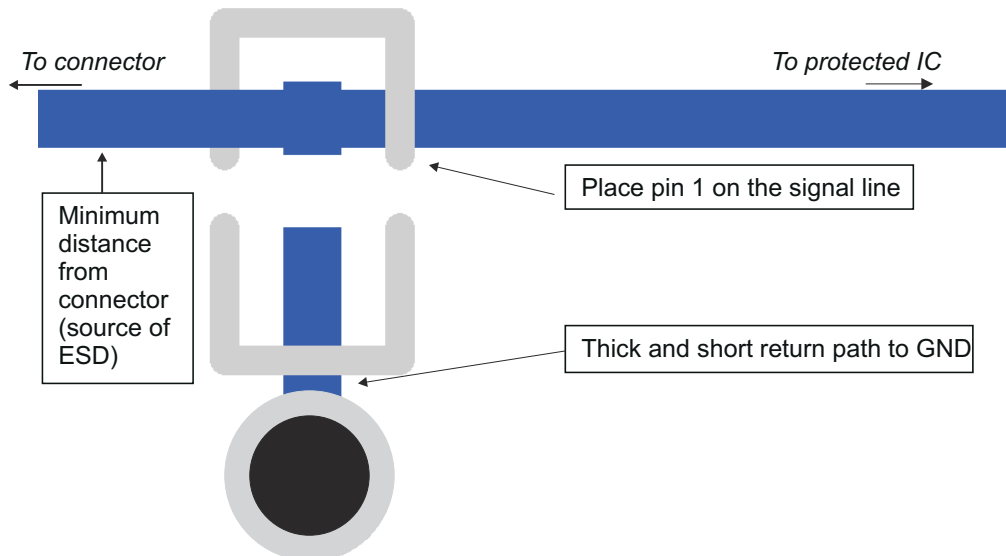

✎ 8-4. Layout Example

9 Device and Documentation Support

9.1 Documentation Support

9.1.1 Related Documentation

For related documentation see the following:

- Texas Instruments, [TPD1E10B09-Q1 Evaluation Module](#)
- Texas Instruments, [Reading and Understanding an ESD Protection Data Sheet](#)
- Texas Instruments, [ESD Layout Guide](#)
- Texas Instruments, [ESD PROTECTION DIODES EVM](#)

9.2 ドキュメントの更新通知を受け取る方法

ドキュメントの更新についての通知を受け取るには、[ti.com](#) のデバイス製品フォルダを開いてください。「更新の通知を受け取る」をクリックして登録すると、変更されたすべての製品情報に関するダイジェストを毎週受け取れます。変更の詳細については、修正されたドキュメントに含まれている改訂履歴をご覧ください。

9.3 サポート・リソース

[TI E2E™ サポート・フォーラム](#)は、エンジニアが検証済みの回答と設計に関するヒントをエキスパートから迅速かつ直接得ることができる場所です。既存の回答を検索したり、独自の質問をしたりすることで、設計に必要な支援を迅速に得ることができます。

リンクされているコンテンツは、該当する貢献者により、現状のまま提供されるものです。これらは TI の仕様を構成するものではなく、必ずしも TI の見解を反映したものではありません。TI の[使用条件](#)を参照してください。

9.4 Trademarks

TI E2E™ is a trademark of Texas Instruments.

すべての商標は、それぞれの所有者に帰属します。

9.5 静電気放電に関する注意事項



この IC は、ESD によって破損する可能性があります。テキサス・インスツルメンツは、IC を取り扱う際には常に適切な注意を払うことを推奨します。正しい取り扱いおよび設置手順に従わない場合、デバイスを破損するおそれがあります。

ESD による破損は、わずかな性能低下からデバイスの完全な故障まで多岐にわたります。精密な IC の場合、パラメータがわずかに変化するだけで公表されている仕様から外れる可能性があるため、破損が発生しやすくなっています。

9.6 用語集

[テキサス・インスツルメンツ用語集](#) この用語集には、用語や略語の一覧および定義が記載されています。

10 Mechanical, Packaging, and Orderable Information

The following pages include mechanical, packaging, and orderable information. This information is the most current data available for the designated devices. This data is subject to change without notice and revision of this document. For browser-based versions of this data sheet, refer to the left-hand navigation.

PACKAGING INFORMATION

Orderable Device	Status (1)	Package Type	Package Drawing	Pins	Package Qty	Eco Plan (2)	Lead finish/ Ball material (6)	MSL Peak Temp (3)	Op Temp (°C)	Device Marking (4/5)	Samples
TPD1E10B09QDPYRQ1	ACTIVE	X1SON	DPY	2	10000	RoHS & Green	NIPDAU	Level-1-260C-UNLIM	-40 to 125	4N	Samples

(1) The marketing status values are defined as follows:

ACTIVE: Product device recommended for new designs.

LIFEBUY: TI has announced that the device will be discontinued, and a lifetime-buy period is in effect.

NRND: Not recommended for new designs. Device is in production to support existing customers, but TI does not recommend using this part in a new design.

PREVIEW: Device has been announced but is not in production. Samples may or may not be available.

OBSOLETE: TI has discontinued the production of the device.

(2) **RoHS:** TI defines "RoHS" to mean semiconductor products that are compliant with the current EU RoHS requirements for all 10 RoHS substances, including the requirement that RoHS substance do not exceed 0.1% by weight in homogeneous materials. Where designed to be soldered at high temperatures, "RoHS" products are suitable for use in specified lead-free processes. TI may reference these types of products as "Pb-Free".

RoHS Exempt: TI defines "RoHS Exempt" to mean products that contain lead but are compliant with EU RoHS pursuant to a specific EU RoHS exemption.

Green: TI defines "Green" to mean the content of Chlorine (Cl) and Bromine (Br) based flame retardants meet JS709B low halogen requirements of <=1000ppm threshold. Antimony trioxide based flame retardants must also meet the <=1000ppm threshold requirement.

(3) MSL, Peak Temp. - The Moisture Sensitivity Level rating according to the JEDEC industry standard classifications, and peak solder temperature.

(4) There may be additional marking, which relates to the logo, the lot trace code information, or the environmental category on the device.

(5) Multiple Device Markings will be inside parentheses. Only one Device Marking contained in parentheses and separated by a "~" will appear on a device. If a line is indented then it is a continuation of the previous line and the two combined represent the entire Device Marking for that device.

(6) Lead finish/Ball material - Orderable Devices may have multiple material finish options. Finish options are separated by a vertical ruled line. Lead finish/Ball material values may wrap to two lines if the finish value exceeds the maximum column width.

Important Information and Disclaimer: The information provided on this page represents TI's knowledge and belief as of the date that it is provided. TI bases its knowledge and belief on information provided by third parties, and makes no representation or warranty as to the accuracy of such information. Efforts are underway to better integrate information from third parties. TI has taken and continues to take reasonable steps to provide representative and accurate information but may not have conducted destructive testing or chemical analysis on incoming materials and chemicals. TI and TI suppliers consider certain information to be proprietary, and thus CAS numbers and other limited information may not be available for release.

In no event shall TI's liability arising out of such information exceed the total purchase price of the TI part(s) at issue in this document sold by TI to Customer on an annual basis.

OTHER QUALIFIED VERSIONS OF TPD1E10B09-Q1 :

- Catalog : [TPD1E10B09](#)

NOTE: Qualified Version Definitions:

- Catalog - TI's standard catalog product

TAPE AND REEL INFORMATION

QUADRANT ASSIGNMENTS FOR PIN 1 ORIENTATION IN TAPE

*All dimensions are nominal

Device	Package Type	Package Drawing	Pins	SPQ	Reel Diameter (mm)	Reel Width W1 (mm)	A0 (mm)	B0 (mm)	K0 (mm)	P1 (mm)	W (mm)	Pin1 Quadrant
TPD1E10B09QDPYRQ1	X1SON	DPY	2	10000	180.0	9.5	0.73	1.13	0.5	2.0	8.0	Q1

TAPE AND REEL BOX DIMENSIONS

*All dimensions are nominal

Device	Package Type	Package Drawing	Pins	SPQ	Length (mm)	Width (mm)	Height (mm)
TPD1E10B09QDPYRQ1	X1SON	DPY	2	10000	189.0	185.0	36.0

GENERIC PACKAGE VIEW

DPY 2

X1SON - 0.45 mm max height

1 x 0.6 mm

PLASTIC SMALL OUTLINE - NO LEAD

This image is a representation of the package family, actual package may vary.
Refer to the product data sheet for package details.



4231484/A

DPY0002A

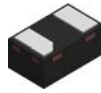

PACKAGE OUTLINE
X1SON - 0.45 mm max height

PLASTIC SMALL OUTLINE - NO LEAD

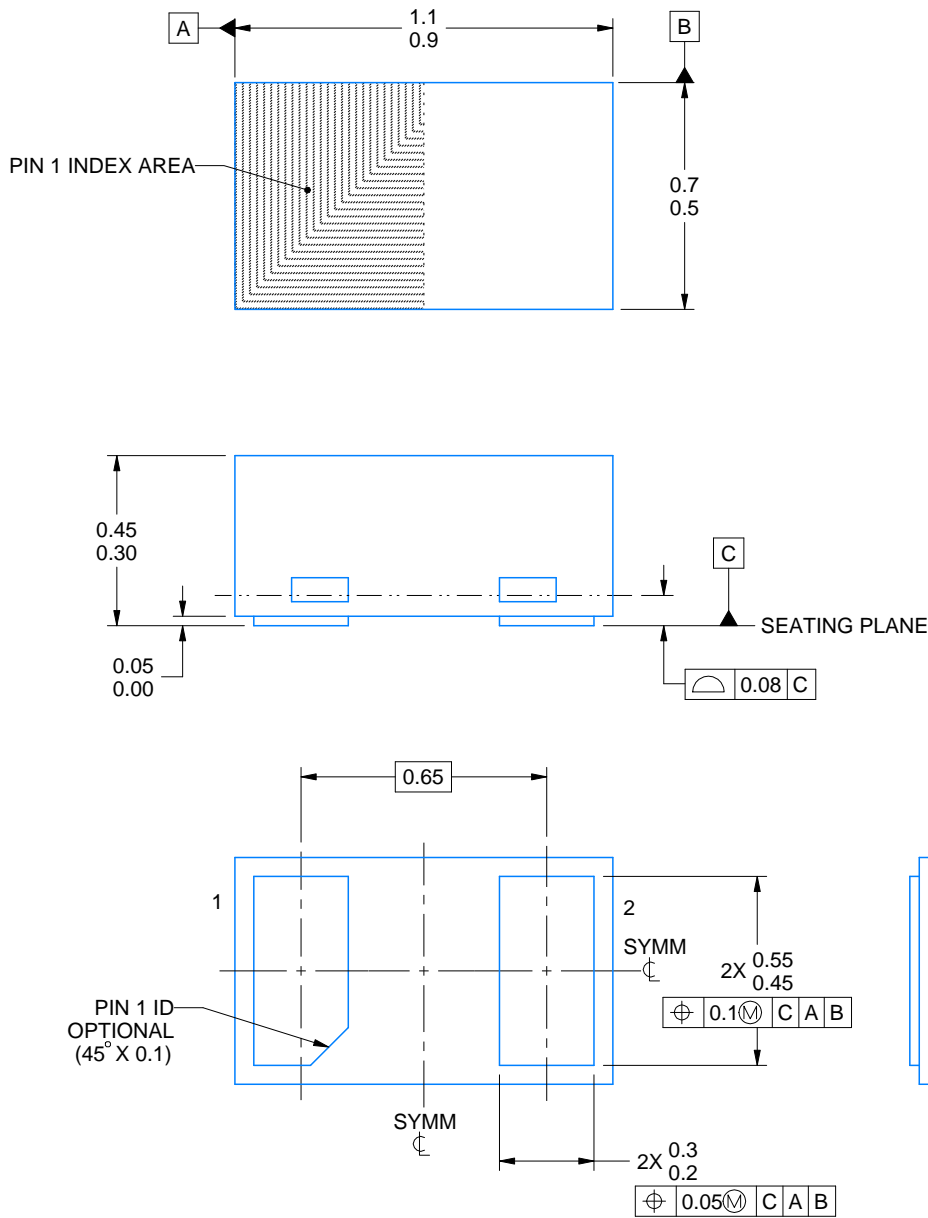

4224561/C 07/2024

NOTES:

1. All linear dimensions are in millimeters. Any dimensions in parenthesis are for reference only. Dimensioning and tolerancing per ASME Y14.5M
2. This drawing is subject to change without notice.

EXAMPLE BOARD LAYOUT

DPY0002A

X1SON - 0.45 mm max height

PLASTIC SMALL OUTLINE - NO LEAD

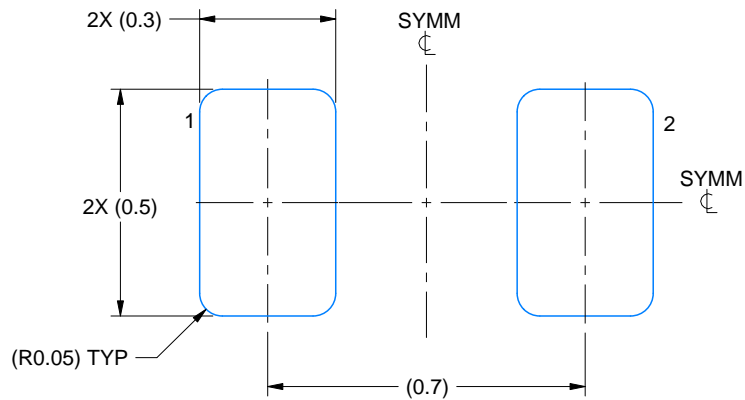

LAND PATTERN EXAMPLE
EXPOSED METAL SHOWN
SCALE:60X

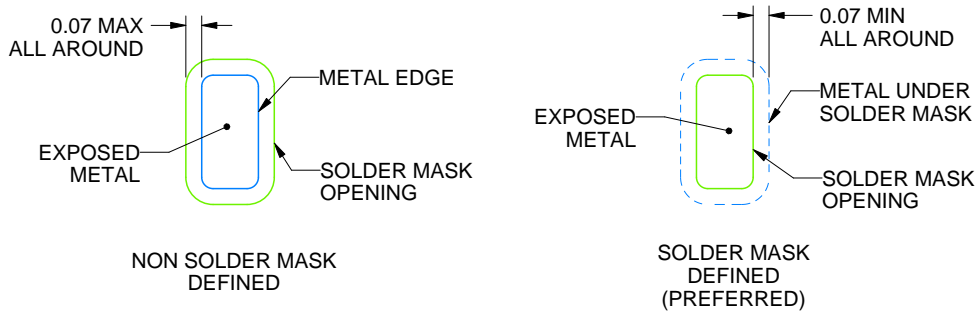

SOLDER MASK DETAILS

4224561/C 07/2024

NOTES: (continued)

3. For more information, see Texas Instruments literature number SLUA271 (www.ti.com/lit/slue271).
4. Vias are optional depending on application, refer to device data sheet. If any vias are implemented, refer to their locations shown on this view. It is recommended that vias under paste be filled, plugged or tented.

EXAMPLE STENCIL DESIGN

DPY0002A

X1SON - 0.45 mm max height

PLASTIC SMALL OUTLINE - NO LEAD

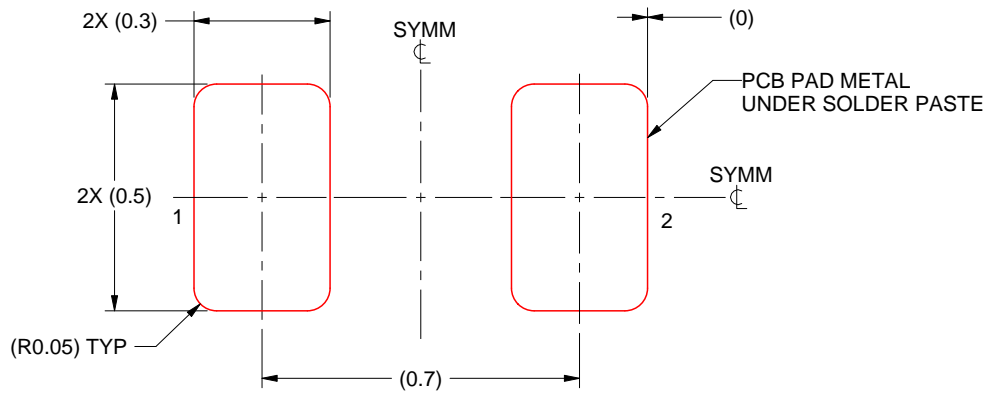

SOLDER PASTE EXAMPLE
BASED ON 0.1 mm THICK STENCIL
SCALE:60X

4224561/C 07/2024

NOTES: (continued)

5. Laser cutting apertures with trapezoidal walls and rounded corners may offer better paste release. IPC-7525 may have alternate design recommendations.

重要なお知らせと免責事項

テキサス・インスツルメンツは、技術データと信頼性データ(データシートを含みます)、設計リソース(リファレンス デザインを含みます)、アプリケーションや設計に関する各種アドバイス、Web ツール、安全性情報、その他のリソースを、欠陥が存在する可能性のある「現状のまま」提供しており、商品性および特定目的に対する適合性の黙示保証、第三者の知的財産権の非侵害保証を含むいかなる保証も、明示的または黙示的にかかわらず拒否します。

これらのリソースは、テキサス・インスツルメンツ製品を使用する設計の経験を積んだ開発者への提供を意図したものです。(1) お客様のアプリケーションに適したテキサス・インスツルメンツ製品の選定、(2) お客様のアプリケーションの設計、検証、試験、(3) お客様のアプリケーションに該当する各種規格や、その他のあらゆる安全性、セキュリティ、規制、または他の要件への確実な適合に関する責任を、お客様のみが単独で負うものとし、ます。

上記の各種リソースは、予告なく変更される可能性があります。これらのリソースは、リソースで説明されているテキサス・インスツルメンツ製品を使用するアプリケーションの開発の目的でのみ、テキサス・インスツルメンツはその使用をお客様に許諾します。これらのリソースに関して、他の目的で複製することや掲載することは禁止されています。テキサス・インスツルメンツや第三者の知的財産権のライセンスが付与されている訳ではありません。お客様は、これらのリソースを自身で使用した結果発生するあらゆる申し立て、損害、費用、損失、責任について、テキサス・インスツルメンツおよびその代理人を完全に補償するものとし、テキサス・インスツルメンツは一切の責任を拒否します。

テキサス・インスツルメンツの製品は、[テキサス・インスツルメンツの販売条件](#)、または [ti.com](https://www.ti.com) やかかるテキサス・インスツルメンツ製品の関連資料などのいずれかを通じて提供する適用可能な条項の下で提供されています。テキサス・インスツルメンツがこれらのリソースを提供することは、適用されるテキサス・インスツルメンツの保証または他の保証の放棄の拡大や変更を意味するものではありません。

お客様がいかなる追加条項または代替条項を提案した場合でも、テキサス・インスツルメンツはそれらに異議を唱え、拒否します。

郵送先住所：Texas Instruments, Post Office Box 655303, Dallas, Texas 75265
Copyright © 2025, Texas Instruments Incorporated