

# TMP119 高精度、低消費電力、デジタル温度センサ

## SMBus™ および I<sup>2</sup>C 互換インターフェイス搭載

### 1 特長

- TMP119 高精度温度センサ
  - 0°C~45°C で ±0.03°C (標準値)
  - 0°C~45°C で ±0.08°C (最大値)
  - -25°C~85°C で ±0.09°C (最大値)
  - -40°C~85°C で ±0.12°C (最大値)
  - -55°C~125°C で ±0.15°C (最大値)
  - -55°C~150°C で ±0.2°C (最大値)
- 動作温度範囲: -55°C~150°C
- 低消費電力:
  - 3.5µA, 1Hz の変換サイクル
  - 150nA シャットダウン電流
- 電源電圧範囲:
  - 1.7V~5.5V (-55°C~70°C)
  - 1.8V~5.5V (-55°C~150°C)
- 16 ビット分解能: 0.0078°C (1 LSB)
- 温度アラート制限をプログラム可能
- 平均化を選択可能
- 歪み耐圧
- デジタル オフセットによるシステム補正
- 汎用 EEPROM: 48 ビット
- NIST トレース可能
- SMBus™、I<sup>2</sup>C インターフェイスと互換
- 医療グレード: ASTM E1112 および ISO 80601-2-56 準拠
- RTD の置き換え: PT100、PT500、PT1000

### 2 アプリケーション

- 電子温度計
- ワイヤレス環境センサ
- サーモスタット
- 車載用試験装置
- ウェアラブル フィットネスおよびアクティビティ モニタ
- コールド チェーン向けアセットトラッキング
- ガス メータおよび熱メータ
- 温度トランスミッタ

### 3 概要

TMP119 は高精度のデジタル温度センサです。このデバイスは、ASTM E1112 および ISO 80601 の電子医療体温計の精度要件を満たすように設計されています。校正不要で、0°C~45°C の温度範囲にわたって 0.0078°C の分解能、最大 ±0.08°C の精度で 16 ビットの温度結果を提供します。TMP119 は、I<sup>2</sup>C および SMBus™ 互換インターフェイスでプログラム可能なアラート機能を備え、1 つのバスで最大 4 つのデバイスをサポートできます。汎用的に使用できる 48 ビットの追加メモリを備えたデバイス設定用 EEPROM も内蔵しています。TMP119 は 1.7V~5.5V で動作し、1Hz の変換サイクルで標準的な消費電流は 3.5µA です。

医療用途以外では、シングル チップのデジタル温度センサとして、白金 RTD の代替になります。TMP119 は Class AA RTD と同等の精度を持ちながら、PT100 RTD で一般的に必要な電力と比べて、わずかな電力しか使用しません。TMP119 では、高精度の基準、配線のマッチング、複雑なアルゴリズム、校正など、RTD の複雑さの多くが解消されるため、設計を簡素化できます。このデバイスはひずみ耐性を持つよう設計されているため、デバイスの半田付け、モールド、アンダーフィル、基板の曲げなど、PCB 製造でよく見られる一般的なひずみに対する堅牢性があります。

TMP119 ユニットは NIST トレース可能な製造時のセットアップで 100% テスト済みであり、ISO/IEC 17025 で認められた標準に従って校正済みの機器により検証されています。

#### パッケージ情報

部品番号	パッケージ <sup>(1)</sup>	パッケージ サイズ <sup>(2)</sup>
TMP119	YBG (DSBGA, 6)	0.95mm × 1.488mm

- (1) 供給されているすべてのパッケージについては、[セクション 11](#) を参照してください。
- (2) パッケージ サイズ (長さ×幅) は公称値であり、該当する場合はピンも含まれます。



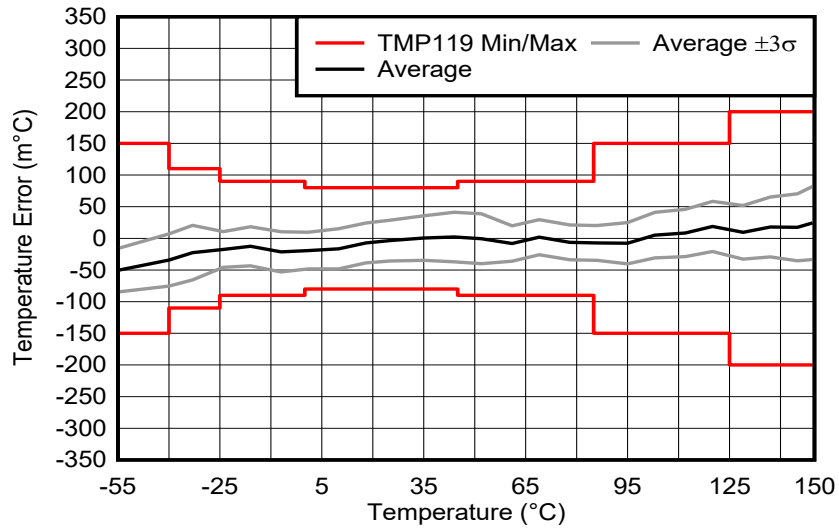

YBG の温度精度

## Table of Contents

<b>1 特長</b> .....	1	7.4 Device Functional Modes.....	16
<b>2 アプリケーション</b> .....	1	7.5 Programming.....	20
<b>3 概要</b> .....	1	<b>8 Application and Implementation</b> .....	27
<b>4 Device Comparison</b> .....	4	8.1 Application Information.....	27
<b>5 Pin Configuration and Functions</b> .....	5	8.2 Typical Application.....	28
<b>6 Specifications</b> .....	6	8.3 Power Supply Recommendations.....	30
6.1 Absolute Maximum Ratings.....	6	8.4 Layout.....	30
6.2 ESD Ratings.....	6	8.5 Register Map.....	32
6.3 Recommended Operating Conditions.....	6	<b>9 Device and Documentation Support</b> .....	41
6.4 Thermal Information.....	6	9.1 Documentation Support.....	41
6.5 Electrical Characteristics.....	7	9.2 ドキュメントの更新通知を受け取る方法.....	41
6.6 Switching Characteristics.....	8	9.3 サポート・リソース.....	41
6.7 Two-Wire Interface Timing.....	8	9.4 Trademarks.....	41
6.8 Timing Diagram.....	10	9.5 静電気放電に関する注意事項.....	41
6.9 Typical Characteristics.....	10	9.6 用語集.....	41
<b>7 Detailed Description</b> .....	13	<b>10 Revision History</b> .....	41
7.1 Overview.....	13	<b>11 Mechanical, Packaging, and Orderable Information</b> .....	42
7.2 Functional Block Diagram.....	13		
7.3 Feature Description.....	14		

## 4 Device Comparison

表 4-1. Device Options

Feature	TMP114	TMP116	TMP116N	TMP117	TMP117M	TMP117N	TMP119
VDD Range (V)	1.08 - 1.98	3.0 - 3.6	3.0 - 3.6	1.7 - 5.5	1.7 - 5.5	1.7 - 5.5	1.7 - 5.5
I <sub>AVG</sub> @ 1Hz	0.63	3.5	3.5	3.5	3.5	3.5	3.5
I <sub>Q_ACTIVE</sub> (μA)	68	135	135	135	135	135	135
I <sub>SB</sub> (μA)	0.26	1.25	1.25	1.25	1.25	1.25	1.25
I <sub>SD</sub> (μA)	0.16	0.25	0.25	0.25	0.25	0.25	0.25
<b>Accuracy</b>							
0°C to 45°C (typ)	0.1	0.1	0.2	0.05	0.05	0.1	0.03
0°C to 45°C (max)	0.2	0.2	0.3	0.1	0.1	0.2	0.08
-55°C (max)	-	-	-	0.25	-	0.3	0.15
-40°C (max)	0.5	0.25	0.4	0.15	-	0.2	0.11
-20°C (max)	0.5	0.25	0.3	0.1	-	0.2	0.09
-10°C (max)	0.3	0.2	0.3	0.1	-	0.2	0.09
-0°C (max)	0.3	0.2	0.3	0.1	0.15	0.2	0.08
20°C (max)	0.2	0.2	0.3	0.1	0.1	0.2	0.08
45°C (max)	0.2	0.2	0.3	0.1	0.1	0.2	0.08
60°C (max)	0.3	0.2	0.3	0.15	0.15	0.2	0.09
85°C (max)	0.5	0.2	0.3	0.2	0.2	0.2	0.15
100°C (max)	0.5	0.25	0.4	0.2	-	0.2	0.15
125°C (max)	0.5	0.3	0.4	0.25	-	0.25	0.2
150°C (max)	-	-	-	0.3	-	0.3	0.2
<b>Packaging</b>							
Dimensions [mm ×mm ×mm]	PICOSTAR: 0.76 x 0.76 x 0.15	WSON: 2.0 x 2.0 x 0.8		BGA: 1.49 x 0.95 x 0.531 WSON: 2.0 x 2.0 x 0.8			BGA: 1.49 x 0.95 x 0.525
<b>Features</b>							
Address #	4	4	4	4	4	4	4
Address Programming	Factory Set	ADD0 Pin	ADD0 Pin	ADD0 Pin	ADD0 Pin	ADD0 Pin	ADD0 Pin
NIST Traceable	No	Yes	Yes	Yes	Yes	Yes	Yes

## 5 Pin Configuration and Functions



図 5-1. YBG Package 6-Pin DSBGA Top View

表 5-1. Pin Functions

PIN		TYPE	DESCRIPTION
NAME	DSBGA		
ADD0	C1	I	Address select. Connect to GND, V+, SDA, or SCL.
ALERT	C2	O	Overtemperature alert or data-ready signal. This open-drain output requires a pullup resistor if used.
GND	B2	—	Ground
SCL	A2	I	Serial clock
SDA	A1	I/O	Serial data input and open-drain output. Requires a pullup resistor.
V+	B1	I	Supply voltage

## 6 Specifications

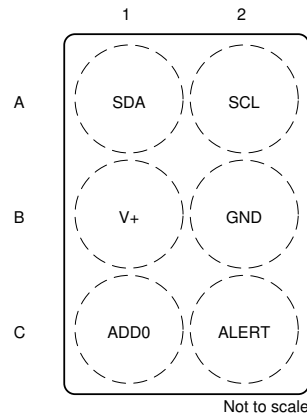
### 6.1 Absolute Maximum Ratings

Over free-air temperature range unless otherwise noted<sup>(1)</sup>

		MIN	MAX	UNIT
Supply voltage	V+	-0.3	6	V
Voltage at	SCL, SDA, ALERT and ADD0	-0.3	6	V
Operating junction temperature, T <sub>J</sub>		-55	155	°C
Storage temperature, T <sub>stg</sub>		-65	155	°C

- (1) Operation outside the Absolute Maximum Ratings may cause permanent device damage. Absolute Maximum Ratings do not imply functional operation of the device at these or any other conditions beyond those listed under Recommended Operating Conditions. If used outside the Recommended Operating Conditions but within the Absolute Maximum Ratings, the device may not be fully functional, and this may affect device reliability, functionality, performance, and shorten the device lifetime.

### 6.2 ESD Ratings

			VALUE	UNIT
V <sub>(ESD)</sub>	Electrostatic discharge	Human-body model (HBM), per ANSI/ESDA/JEDEC JS-001 <sup>(1)</sup>	±2000	V
		Charged-device model (CDM), per JEDEC specification JESD22-C101 <sup>(2)</sup>	±1000	

- (1) JEDEC document JEP155 states that 500V HBM allows safe manufacturing with a standard ESD control process.  
 (2) JEDEC document JEP157 states that 250V CDM allows safe manufacturing with a standard ESD control process.

### 6.3 Recommended Operating Conditions

		MIN	NOM	MAX	UNIT
V+	Supply voltage, T <sub>A</sub> = -55 °C to 150 °C	1.8	3.3	5.5	V
V+	Supply voltage, T <sub>A</sub> = -55 °C to 70 °C	1.7		5.5	V
V <sub>I/O</sub>	SCL, SDA, ALERT and ADD0	0		5.5	V
T <sub>A</sub>	Operating free-air temperature	-55		150	°C

### 6.4 Thermal Information

THERMAL METRIC <sup>(1)</sup>		TMP119	UNITS
		YBG (DSBGA)	
		6 PINS	
R <sub>θJA</sub>	Junction-to-ambient thermal resistance	133.2	°C/W
R <sub>θJC(top)</sub>	Junction-to-case (top) thermal resistance	1.0	°C/W
R <sub>θJC(bot)</sub>	Junction-to-case (bottom) thermal resistance	N/A	°C/W
R <sub>θJB</sub>	Junction-to-board thermal resistance	40.9	°C/W
ψ <sub>JT</sub>	Junction-to-top characterization parameter	0.1	°C/W
ψ <sub>JB</sub>	Junction-to-board characterization parameter	40.7	°C/W
M <sub>T</sub>	Thermal Mass	0.7	mJ/°C

- (1) For more information about traditional and new thermal metrics, see the [Semiconductor and IC Package Thermal Metrics](#) application note.

## 6.5 Electrical Characteristics

Over free-air temperature range and  $V_+ = 1.7V$  to  $5.5V$  for  $T_A = -55^\circ C$  to  $70^\circ C$ , or  $V_+ = 1.8V$  to  $5.5V$  for  $T_A = -55^\circ C$  to  $150^\circ C$  (unless otherwise noted); Typical specifications are at  $T_A = 25^\circ C$  and  $V_+ = 3.3V$  (unless otherwise noted)

PARAMETER		TEST CONDITIONS		MIN	TYP	MAX	UNIT	
<b>TEMPERATURE TO DIGITAL CONVERTER</b>								
Temperature accuracy	TMP119		0°C to 45°C	8 averages 1-Hz conversion cycle I <sup>2</sup> C Input voltages: $V_{IL} \leq 0.05 * V_+$ , $V_{IH} \geq 0.95 * V_+$	-0.08	±0.03	0.08	°C
			-25°C to 85°C		-0.09	±0.03	0.09	
			-40°C to 85°C		-0.12	±0.06	0.12	
			-55°C to 125°C		-0.15	±0.06	0.15	
			-55°C to 150°C		-0.2	±0.06	0.2	
	TMP119M	0°C to 45°C	-0.08		±0.03	0.08		
		-20°C to 65°C	-0.09		±0.03	0.09		
DC power supply sensitivity		One-shot mode, 8 internal averages		6		m°C/V		
Response Time	Response Time	t <sub>63%</sub> step Stirred liquid 31mil thick rigid PCB	t <sub>63%</sub> step Stirred liquid 31mil thick rigid PCB	1		s		
Gain Error		Maximum Temp Error Drift over 10°C		-0.04	0.04		°C	
Temperature resolution (LSB)				7.8125		m°C		
Repeatability <sup>(1)</sup>		V <sub>+</sub> = 3.3 V 8 averages 1-Hz conversion cycle		±1		LSB		
Long-term stability and drift		1000 hours at 150°C <sup>(2)</sup>		±0.03		°C		
Temperature cycling and hysteresis <sup>(3)</sup>		8 Averages		±2		LSB		
Conversion time		No internal averages		13	15.5	17.5	ms	
<b>DIGITAL INPUT/OUTPUT</b>								
Input capacitance				4		pF		
V <sub>IH</sub>	Input logic high level	SCL, SDA, ADD0		0.7 * (V <sub>+</sub> )		V		
V <sub>IL</sub>	Input logic low level	SCL, SDA, ADD0		0.3 * (V <sub>+</sub> )		V		
I <sub>IN</sub>	Input leakage current			-0.1	0.1		µA	
V <sub>OL</sub>	SDA and ALERT output logic low level	I <sub>OL</sub> = -3mA				0.4	V	

Over free-air temperature range and  $V+ = 1.7V$  to  $5.5V$  for  $T_A = -55^\circ C$  to  $70^\circ C$ , or  $V+ = 1.8V$  to  $5.5V$  for  $T_A = -55^\circ C$  to  $150^\circ C$  (unless otherwise noted); Typical specifications are at  $T_A = 25^\circ C$  and  $V+ = 3.3V$  (unless otherwise noted)

PARAMETER		TEST CONDITIONS	MIN	TYP	MAX	UNIT
<b>POWER SUPPLY</b>						
$I_{Q\_ACTIV E}$	Quiescent current during active conversion	Active Conversion, serial bus inactive		135	220	$\mu A$
$I_Q$	Quiescent current	Duty cycle 1Hz, averaging mode off, serial bus inactive. $T_A = 25^\circ C$		3.5	5	$\mu A$
		Duty cycle 1Hz, 8 averaging mode on, serial bus inactive. $T_A = 25^\circ C$		16	22	
		Duty cycle 1Hz, averaging mode off, serial bus active, SCL frequency = 400kHz		15		
$I_{SB}$	Standby current <sup>(4)</sup>	Serial bus inactive. SCL, SDA, and ADD0 = V+. $T_A = 25^\circ C$		1.25	2	$\mu A$
$I_{SD}$	Shutdown current	Serial bus inactive, SCL, SDA, and ADD0 = V+. $T_A = 25^\circ C$		0.15	0.35	$\mu A$
	Shutdown current	Serial bus inactive, SCL, SDA and ADD0 = V+, $T_A = 150^\circ C$			5	$\mu A$
	Shutdown current	Serial bus active, SCL frequency = 400kHz, ADD0 = V+		17		$\mu A$
$I_{EE}$	EEPROM write quiescent current	ADC conversion off; serial bus inactive		240		$\mu A$
$V_{POR}$	Power-on-reset threshold voltage	Supply rising		1.6		V
	Brownout detect	Supply falling		1.1		V
$t_{RESET}$	Reset Time	Time required by device to reset		1.5		ms

- (1) Repeatability is the ability to reproduce a reading when the measured temperature is applied consecutively, under the same conditions.
- (2) Long term stability is determined using accelerated operational life testing at a junction temperature of  $150^\circ C$ .
- (3) Hysteresis is defined as the ability to reproduce a temperature reading as the temperature varies from room  $\rightarrow$  hot  $\rightarrow$  room  $\rightarrow$  cold  $\rightarrow$  room. The temperatures used for this test are  $-55^\circ C$ ,  $25^\circ C$ , and  $150^\circ C$ .
- (4) Quiescent current between conversions

## 6.6 Switching Characteristics

Over free-air temperature range and  $V+ = 1.7V$  to  $5.5V$  for  $T_A = -55^\circ C$  to  $70^\circ C$ , or  $V+ = 1.8V$  to  $5.5V$  for  $T_A = -55^\circ C$  to  $150^\circ C$  (unless otherwise noted); Typical specifications are at  $T_A = 25^\circ C$  and  $V+ = 3.3V$  (unless otherwise noted)

PARAMETER		TEST CONDITIONS	MIN	TYP	MAX	UNIT
<b>EEPROM</b>						
Programming time				7		ms
Number of writes			1,000	50,000		Times
Data retention time			10	100		Years

## 6.7 Two-Wire Interface Timing

Over free-air temperature range and  $V+ = 1.7V$  to  $5.5V$  for  $T_A = -55^\circ C$  to  $70^\circ C$ , or  $V+ = 1.8V$  to  $5.5V$  for  $T_A = -55^\circ C$  to  $150^\circ C$  (unless otherwise noted)

		STANDARD		FAST-MODE		UNIT
		MIN	MAX	MIN	MAX	
$f_{SCL}$	SCL operating frequency	1		1	400	KHz
$t_{BUF}$	Bus free time between STOP and START conditions			1300		ns
$t_{HD,STA}$	Hold time after repeated START condition. After this period, the first clock is generated <sup>(1)</sup>	5		600		ns
$t_{SU,STA}$	Repeated START condition setup time			600		ns
$t_{SU,STO}$	STOP condition setup time			600		ns



Over free-air temperature range and  $V+ = 1.7V$  to  $5.5V$  for  $T_A = -55^{\circ}C$  to  $70^{\circ}C$ , or  $V+ = 1.8V$  to  $5.5V$  for  $T_A = -55^{\circ}C$  to  $150^{\circ}C$  (unless otherwise noted)

		STANDARD		FAST-MODE		UNIT
		MIN	MAX	MIN	MAX	
$t_{HD;DAT}$	Data hold time			0		ns
$t_{VD;DAT}$	Data valid time <sup>(2)</sup>				0.9	$\mu s$
$t_{SU;DAT}$	Data setup time			100		ns
$t_{LOW}$	SCL clock low period			1300		ns
$t_{HIGH}$	SCL clock high period			600		ns
$t_F - SDA$	Data fall time			$20 \times (V+ / 5.5)$	300	ns
$t_F, t_R - SCL$	Clock fall and rise time				300	ns
$t_R$	Rise time for SCL $\leq 100$ kHz				1000	ns
	Serial bus timeout (SDA bus released if there is no clock)			20	40	ms

- (1) The maximum  $t_{HD;DAT}$  could be  $0.9 \mu s$  for Fast-Mode, and is less than the maximum  $t_{VD;DAT}$  by a transition time.  
 (2)  $t_{VD;DAT}$  = time for data signal from SCL "LOW" to SDA output ("HIGH" to "LOW", depending on which is worse).

## 6.8 Timing Diagram



图 6-1. Two-Wire Timing Diagram

## 6.9 Typical Characteristics

at  $T_A = 25^\circ\text{C}$ ,  $V_+ = 3.3\text{V}$ , and measurement taken in oil bath (unless otherwise noted)

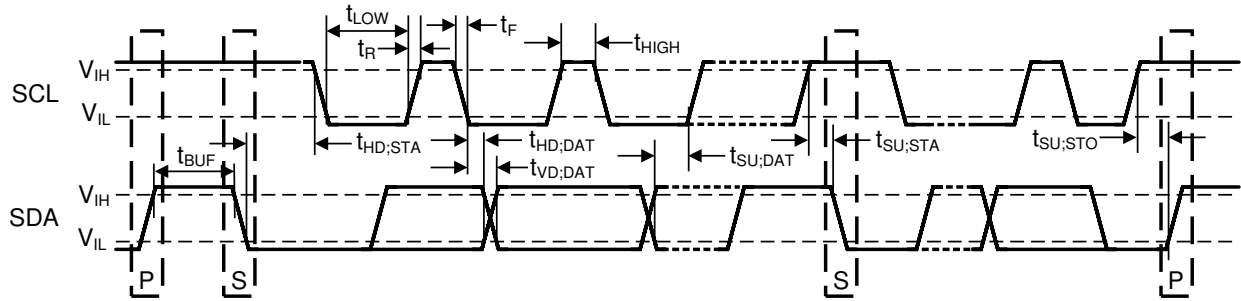

图 6-2. YBG Package Temperature Error vs Temperature



图 6-3. Temperature Error vs Supply Voltage

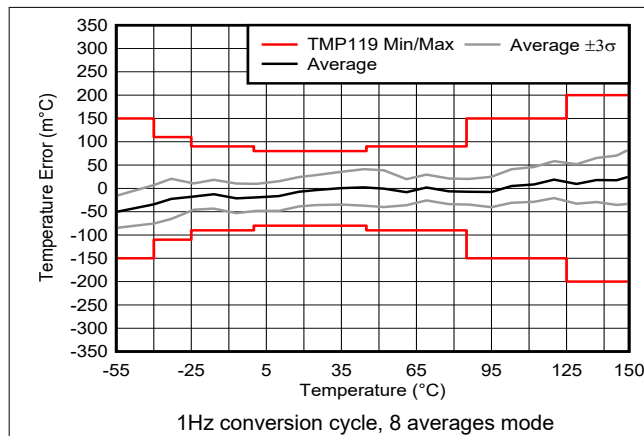

图 6-4. Data Reading Distribution (No Averaging,  $V_+ = 3.3\text{V}$ )

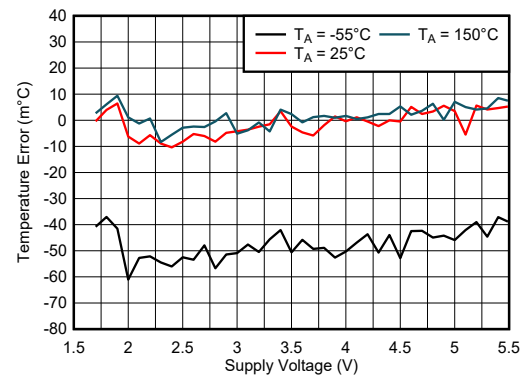

$T_A = 25^\circ\text{C}$ ,  $V_+ = 3.3\text{V}$ . One-shot mode with averaging = 8.

图 6-5. Typical Temperature Distribution Error

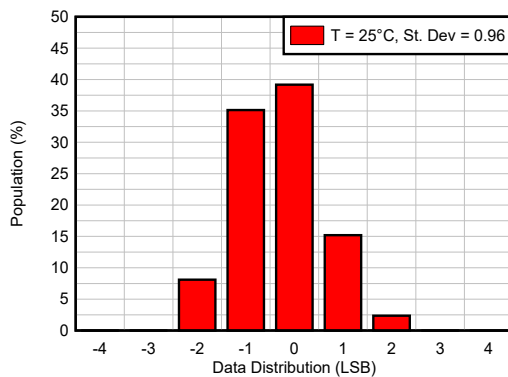
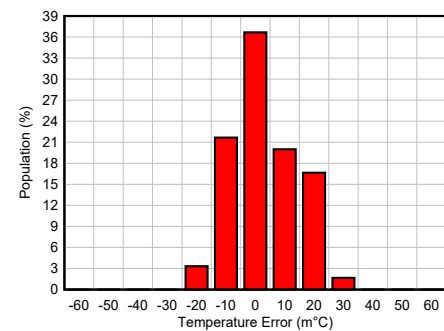
## 6.9 Typical Characteristics (continued)

at  $T_A = 25^\circ\text{C}$ ,  $V_+ = 3.3\text{V}$ , and measurement taken in oil bath (unless otherwise noted)

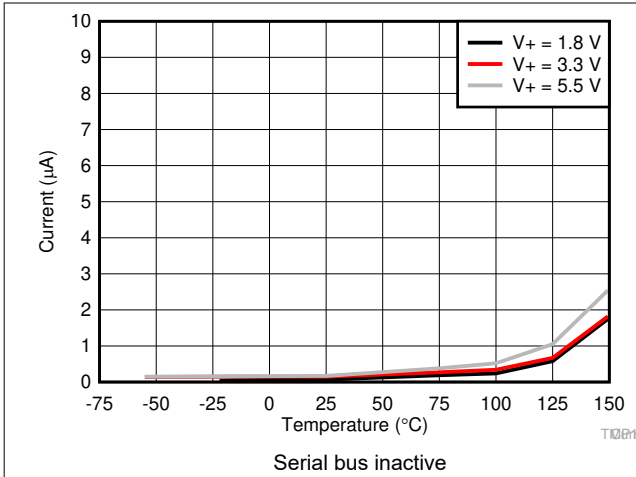

6-6. Quiescent Current in Shutdown Mode

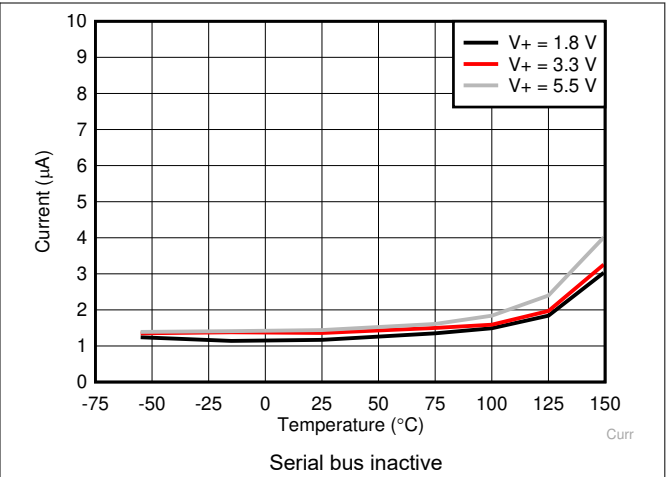

6-7. Quiescent Current in Standby Mode

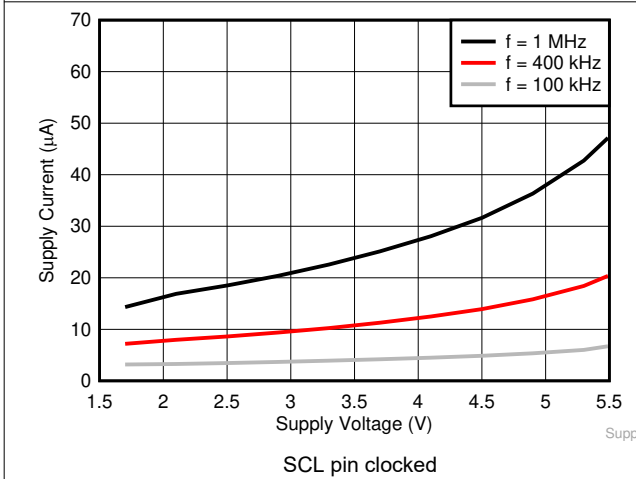

6-8. Quiescent Current in Shutdown Mode

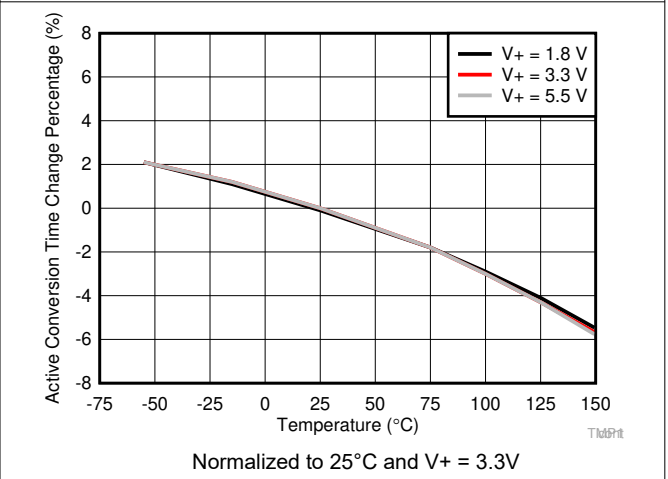

6-9. Active Conversion Time vs Temperature

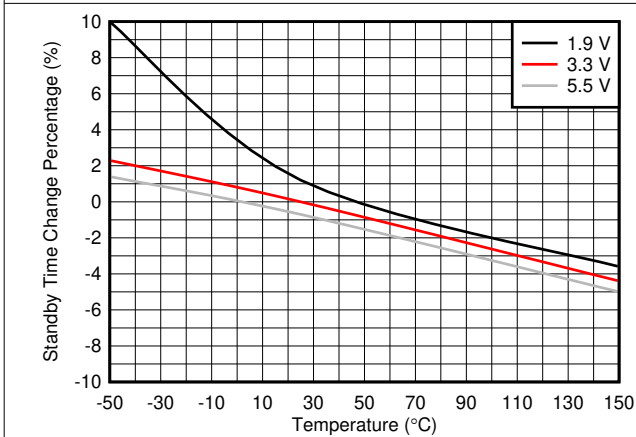

6-10. Standby Time vs Temperature

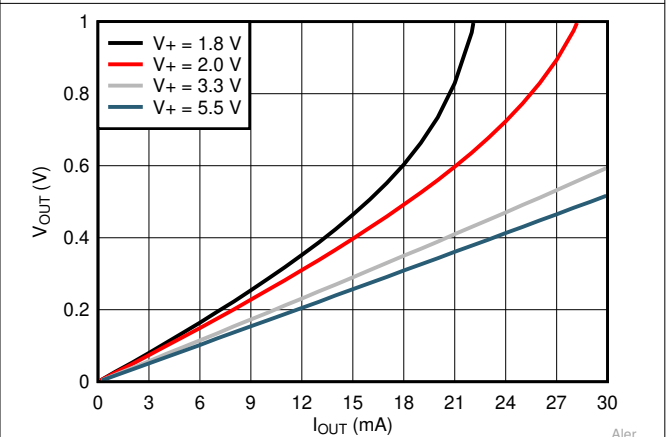

6-11. ALERT Pin Output Voltage vs Pin Sink Current

## 6.9 Typical Characteristics (continued)

at  $T_A = 25^\circ\text{C}$ ,  $V_+ = 3.3\text{V}$ , and measurement taken in oil bath (unless otherwise noted)



图 6-12. Supply Current vs Input Cell Voltage



图 6-13. Temperature Error vs Microstrain

## 7 Detailed Description

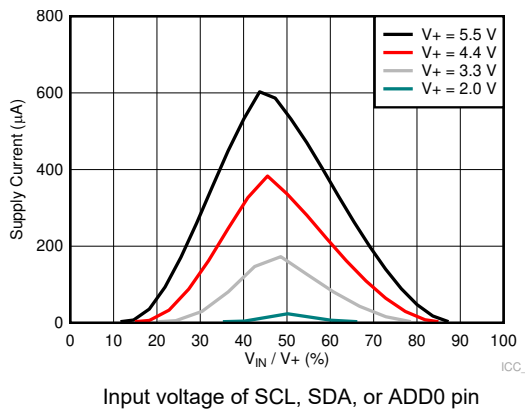
### 7.1 Overview

The TMP119 is a digital output temperature sensor designed for thermal-management and thermal-protection applications. The TMP119 is two-wire, SMBus, and I<sup>2</sup>C interface-compatible. The device is specified over an ambient air operating temperature range of –55°C to 150°C. [Figure 7-1](#) shows a block diagram of the TMP119.

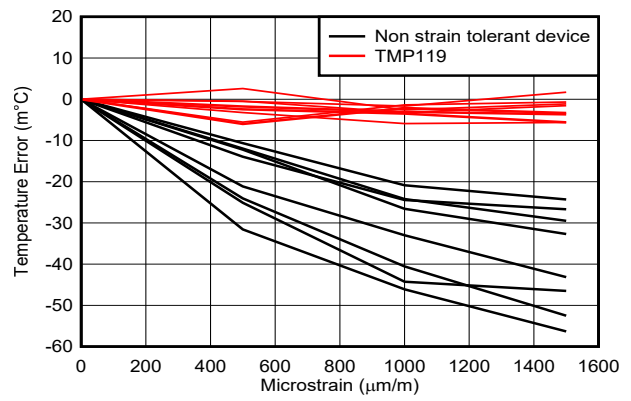
### 7.2 Functional Block Diagram

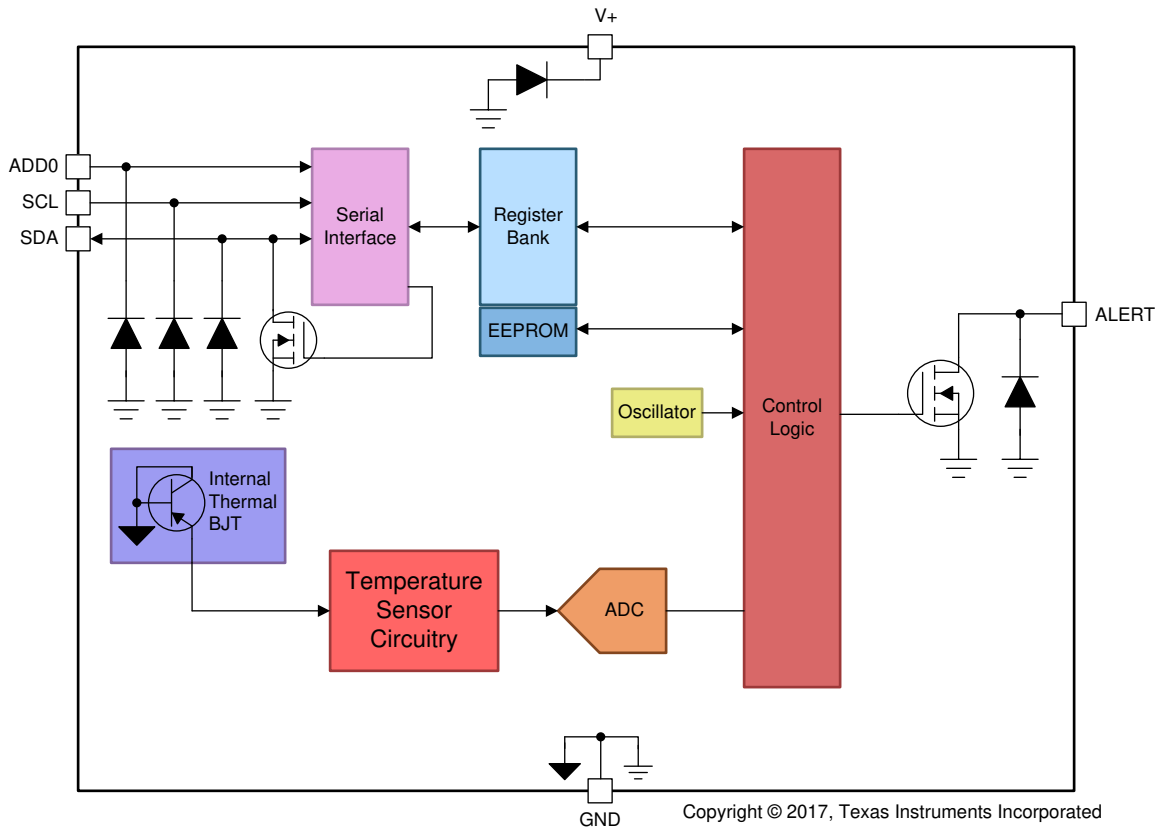

**Figure 7-1. Internal Block Diagram**

## 7.3 Feature Description

### 7.3.1 Power Up

After the supply voltage reaches within the operating range, the device requires 1.5ms to power up before conversions can begin. The device can be programmed to start up in shutdown mode as well. See the [EEPROM Programming](#) section for more information. The [temperature register](#) reads  $-256^{\circ}\text{C}$  before the first conversion.

### 7.3.2 Averaging

Users can configure the device to report the average of multiple temperature conversions with the [AVG\[1:0\]](#) bits to reduce noise in the conversion results. When the TMP119 is configured to perform averaging with AVG set to 01, the device executes the configured number of conversions to eight. The device accumulates those conversion results and reports the average of all the collected results at the end of the process.

 [7-2](#) shows the total conversion cycle time trade-off when using the averaging mode to achieve this improvement in noise performance. Averaging will increase the average active current consumption due to increasing the active conversion time in a conversion cycle. For example a single active conversion typically takes 15.5ms, so if the device is configured to report an average of eight conversions, then the active conversion time is 124ms ( $15.5\text{ms} \times 8$ ). Use [式 1](#) to factor in this increase in active conversion time to accurately calculate the average current consumption of the device. The average current consumption of the device can be decreased by increasing the amount of time the device spends in standby period as compared to active conversion. Under the factory EEPROM settings, the device is configured to report an average of eight conversions with a conversion cycle time of 1 second by default.

Averaging can be used in both the continuous conversion mode and the one-shot mode.

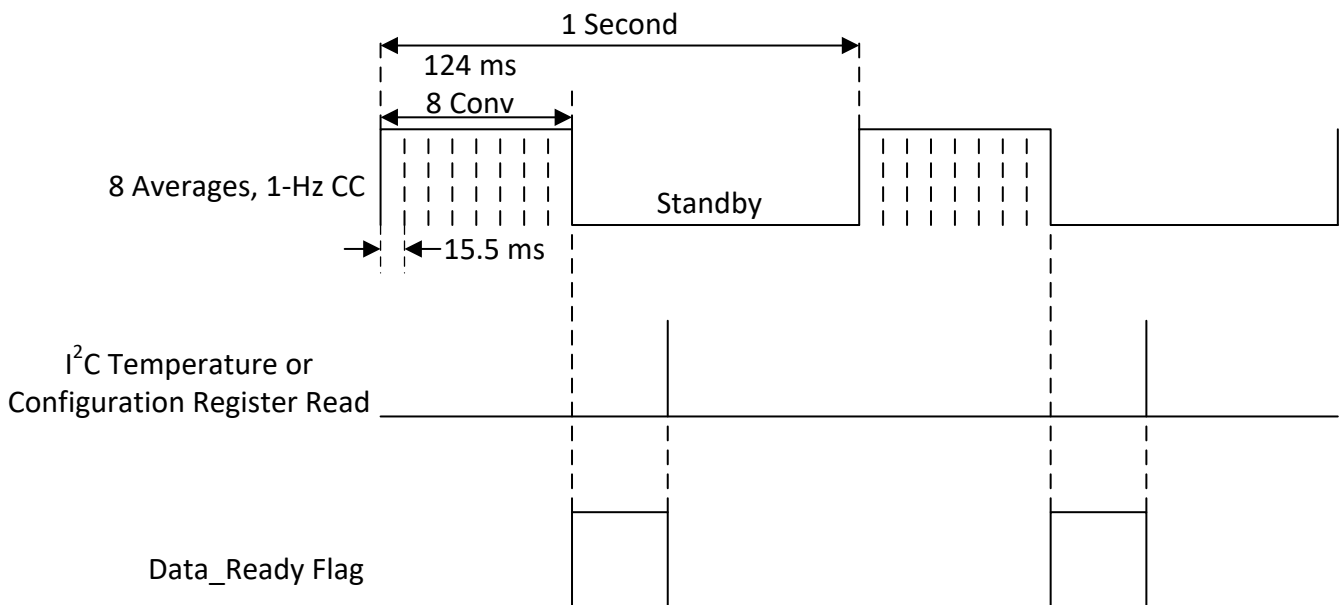

**図 7-2. Averaging Timing Diagram**

### 7.3.3 Temperature Result and Limits

At the end of every conversion, the device updates the temperature register with the conversion result. The data in the result register is in 2's complement format, has a data width of 16 bits and a resolution of 7.8125m°C. [表 7-1](#) shows multiple examples of possible binary data that can be read from the temperature result register and the corresponding hexadecimal and temperature equivalents.

The TMP119 also has alert status flags and alert pin functionality that use the temperature limits stored in the [low limit register](#) and [high limit register](#). The same data format used for the temperature result register is used for data written to the high and low limit registers.

**表 7-1. 16-Bit Temperature Data Format**

TEMPERATURE (°C)	TEMPERATURE REGISTER VALUE (0.0078125°C RESOLUTION)	
	BINARY	HEX
-256	1000 0000 0000 0000	8000
-25	1111 0011 1000 0000	F380
-0.1250	1111 1111 1111 0000	FFF0
-0.0078125	1111 1111 1111 1111	FFFF
0	0000 0000 0000 0000	0000
0.0078125	0000 0000 0000 0001	0001
0.1250	0000 0000 0001 0000	0010
1	0000 0000 1000 0000	0080
25	0000 1100 1000 0000	0C80
100	0011 0010 0000 0000	3200
255.9921	0111 1111 1111 1111	7FFF

### 7.3.4 Strain Tolerance

The TMP119 features internal strain tolerance that helps mitigate error resulting from strain developed in the DSBGA package from various common manufacturing areas, including but not limited to device solder, molding, under-fill, and board flex.

To demonstrate this capability, multiple TMP119 devices are soldered onto a rigid 62mil thick PCB, and tested under multiple flexing orientations, with pin 1 located both orthogonal and parallel to the applied microstrain examined during the test, measured through a strain gauge. The resultant temp error under this strain is measured against a known reference, and are recorded at increasing flex levels of the PCB. [図 7-3](#) demonstrates device distribution under these microstrain conditions. Several non-strain tolerant devices were also subjected to the same test to demonstrate the difference.



図 7-3. Strain Tolerance

## 7.4 Device Functional Modes

The TMP119 can be configured to operate in various conversion modes by using the MOD[1:0] bits. These modes provide flexibility to operate the device in the most power efficient way necessary for the intended application.

### 7.4.1 Continuous Conversion Mode

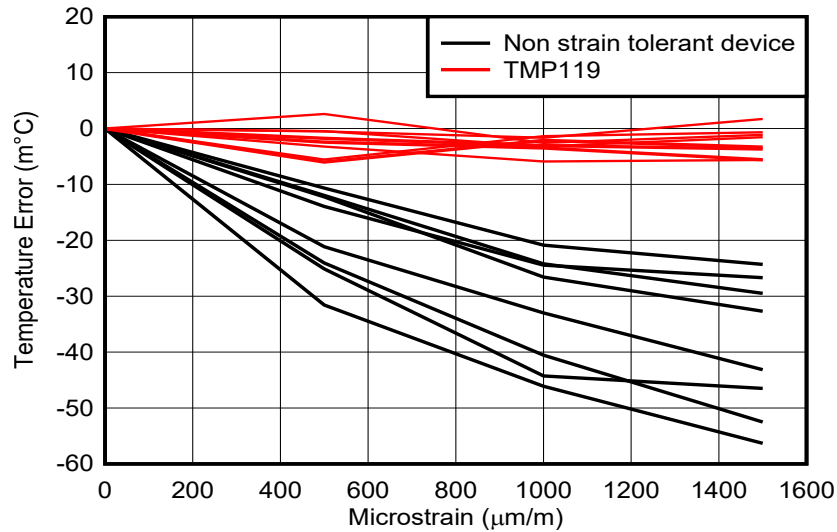
When the MOD[1:0] bits are set to 00 or 10 in the [configuration register](#), the device operates in continuous conversion mode. The device continuously performs temperature conversions in this mode, as shown in [图 7-4](#), and updates the temperature result register at the end of every active conversion. The user can read the configuration register or the temperature result register to clear the Data\_Ready flag. Therefore, the Data\_Ready flag can be used to determine when the conversion completes so that an external controller can synchronize reading the result register with conversion result updates. The user can set the DR/nAlert\_EN bit in the configuration register to monitor the state of the Data\_Ready flag on the ALERT pin.

Every conversion cycle consists of an active conversion period followed by a standby period. The device typically consumes 135μA during active conversion and only 1.25μA during the low-power standby period. [图 7-4](#) shows a current consumption profile of a conversion cycle while in continuous current mode. The duration of the active conversion period and standby period can be configured using the CONV[2:0] and AVG[1:0] bits in the [configuration register](#), thereby allowing the average current consumption of the device to be optimized based on the application requirements. Changing the conversion cycle period also affects the temperature result update rate because the temperature result register is updated at the end of every active conversion.

Use [式 1](#) to calculate the average current consumption of the device in continuous conversion mode.

$$\frac{(\text{Active Current Consumption} \times \text{Active Conversion Time}) + (\text{Standby Current Consumption} \times \text{Standby Time})}{\text{Conversion Cycle Time}} \quad (1)$$



图 7-4. Conversion Cycle Timing Diagram



### 7.4.2 Shutdown Mode (SD)

When the MOD[1:0] bits are set to 01 in the [configuration register](#), the device instantly aborts the currently running conversion and enters a low-power shutdown mode. In this mode, the device powers down all active circuitry and can be used in conjunction with the OS mode to perform temperature conversions. Engineers can use the TMP119 for battery-operated systems and other low-power consumption applications because the device typically only consumes 250nA in SD mode.

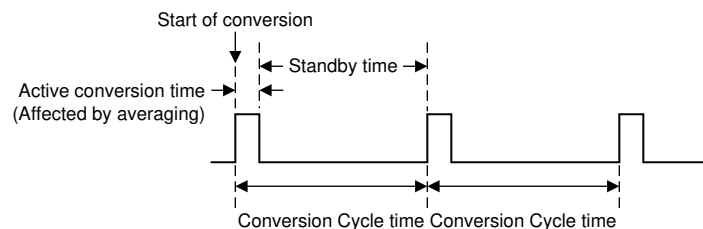
### 7.4.3 One-Shot Mode (OS)

When the MOD[1:0] bits are set to 11 in the [configuration register](#), the TMP119 can run a temperature conversion referred to as a one-shot conversion. After the device completes a one-shot conversion, the device goes to the low-power shutdown mode. A one-shot conversion cycle, unlike the continuous conversion mode, only consists of the active conversion time and no standby period. Thus, the duration of a one-shot conversion is only affected by the AVG bit settings. The CONV bits do not affect the duration of a one-shot conversion. [Figure 7-5](#) shows a timing diagram for this mode with an AVG setting of 00. At the end of a one-shot conversion, the Data\_Ready and ALERT flag in the configuration register is set. The Data\_Ready flag can be used to determine when the conversion completes. The user can perform an I<sup>2</sup>C read on the configuration register or temperature result register to clear the Data\_Ready flag. The user can also set the DR/nAlert\_EN bit in the configuration register to monitor the state of the Data\_Ready flag on the ALERT pin.

One-shot mode cannot be programmed to a default start-up mode. If the EEPROM is programmed to be in one-shot mode on start-up, the device will default to shutdown mode instead.

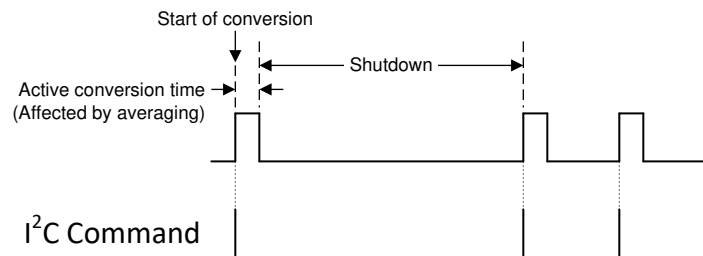

**Figure 7-5. One-Shot Timing Diagram With AVG[1:0] = 00**

### 7.4.4 Therm and Alert Modes

The built-in therm and alert functions of the TMP119 can alert the user if the temperature has crossed a certain temperature limit or if the device is within a certain temperature range. At the end of every conversion, including averaging, the TMP119 compares the converted temperature result to the values stored in the [low limit register](#) and [high limit register](#). The device then either sets or clears the corresponding status flags in the configuration register, as described in this section.

### 7.4.4.1 Alert Mode

When the T/nA bit in the [configuration register](#) is set to 0, the device is in alert mode. In this mode, the device compares the conversion result at the end of every conversion with the values in the [low limit register](#) and [high limit register](#). If the temperature result exceeds the value in the high limit register, the HIGH\_Alert status flag in the configuration register is set. If the temperature result is lower than the value in the low limit register, the LOW\_Alert status flag in the configuration register is set. As shown in [Figure 7-6](#), the user can run an I<sup>2</sup>C read from the configuration register to clear the status flags in alert mode.

When a user configures the device in alert mode, the mode affects the behavior of the ALERT pin. The device asserts the ALERT pin in this mode when either the HIGH\_Alert or the LOW\_Alert status flag is set, as shown in [Figure 7-6](#). The user can either run an I<sup>2</sup>C read of the configuration register (which also clears the status flags) or run an SMBus alert response command (see the [SMBus Alert Function](#) section) to deassert the ALERT pin. The polarity of the ALERT pin can be changed by using the POL bit setting in the configuration register.

This mode effectively makes the device behave like a window limit detector. Thus this mode can be used in applications where detecting if the temperature goes outside of the specified range is necessary.

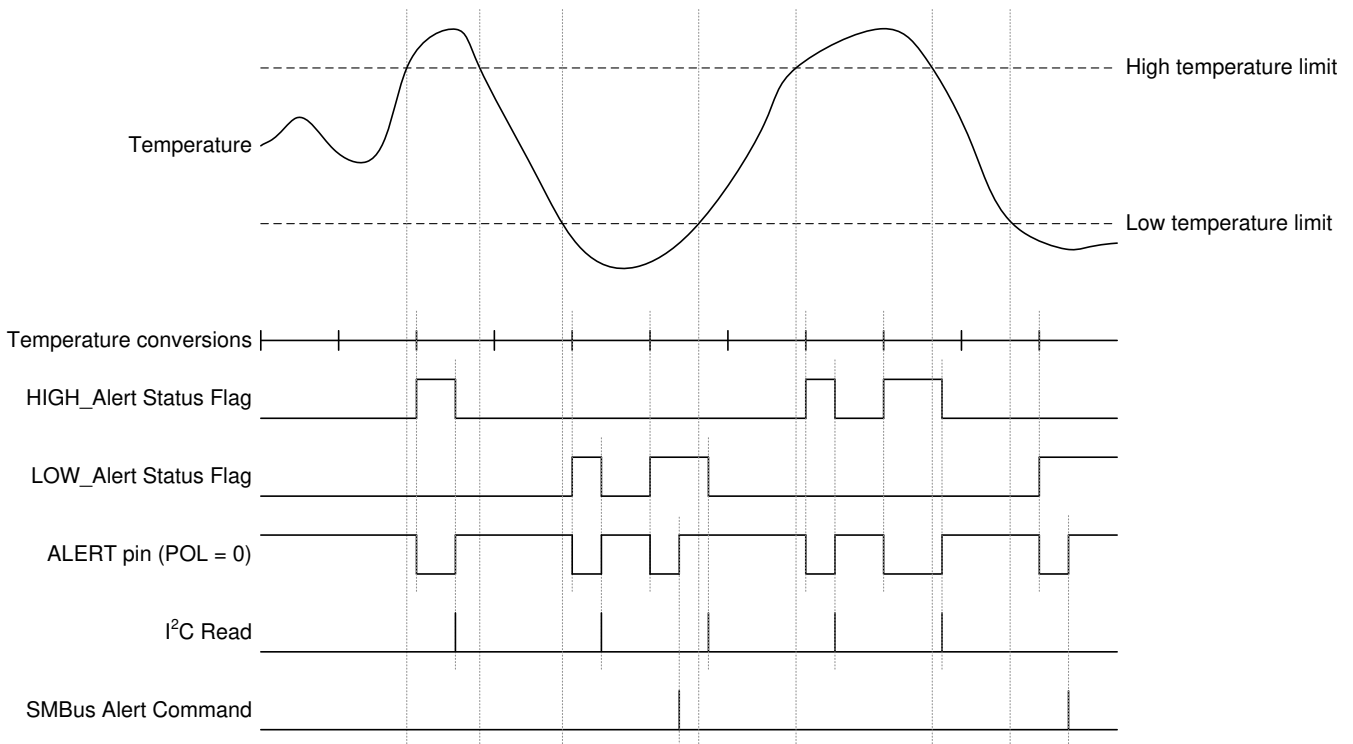

**Figure 7-6. Alert Mode Timing Diagram**

#### 7.4.4.2 Therm Mode

When the T/nA bit in the [configuration register](#) is set to 1, the device is in therm mode. In this mode, the device compares the conversion result at the end of every conversion with the values in the [low limit register](#) and [high limit register](#) and sets the HIGH\_Alert status flag in the configuration register if the temperature exceeds the value in the high limit register. When set, the device clears the HIGH\_Alert status flag if the conversion result goes below the value in the low limit register. Thus, the difference between the high and low limits effectively acts like a hysteresis. In this mode, the LOW\_Alert status flag is disabled and always reads 0. Unlike the alert mode, I<sup>2</sup>C reads of the configuration register do not affect the status bits. The HIGH\_Alert status flag is only set or cleared at the end of conversions based on the value of the temperature result compared to the high and low limits.

As in alert mode, configuring the device in therm mode also affects the behavior of the ALERT pin. In this mode, the device asserts the ALERT pin if the HIGH\_Alert status flag is set and deasserts the ALERT pin when the HIGH\_Alert status flag is cleared. In therm mode, the ALERT pin cannot be cleared by performing an I<sup>2</sup>C read of the configuration register or by performing an SMBus alert response command. As in alert mode, the polarity of the active state of the ALERT pin can be changed if the user adjusts the POL bit setting in the configuration register.

Thus, this mode effectively makes the device behave like a high-limit threshold detector. This mode can be used in applications where detecting if the temperature has gone above a desired threshold is necessary. [Figure 7-7](#) shows a timing diagram of this mode.

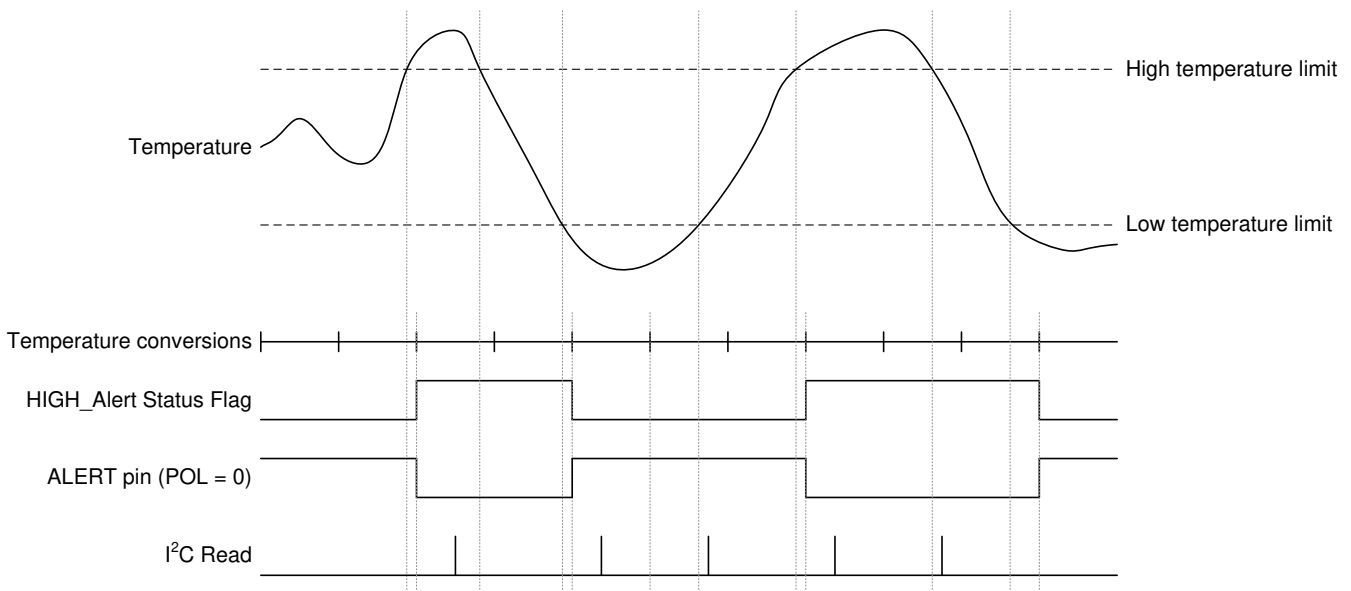

**Figure 7-7. Therm Mode Timing Diagram**

## 7.5 Programming

### 7.5.1 EEPROM Programming

#### 7.5.1.1 EEPROM Overview

The device has a user-programmable EEPROM that can be used for two purposes:

- Storing power-on reset (POR) values of the high limit register, low limit register, conversion cycle time, averaging mode, conversion mode (continuous or shutdown mode), alert function mode (alert or therm mode), and alert polarity
- Storing four 16-bit locations for general-purpose use. See the [EEPROM\[4:1\] registers](#) for more information.

On reset, the device goes through a POR sequence that loads the values programmed in the EEPROM into the respective register map locations. This process takes approximately 1.5ms. When the power-up sequence is complete, the device starts operating in accordance to the configuration parameters that are loaded from the EEPROM. Any I<sup>2</sup>C writes performed during this initial POR period to the limit registers or the configuration register are ignored. I<sup>2</sup>C read transactions can still be performed with the device during the power-up period. While the POR sequence is being executed, the EEPROM\_Busy status flag in the [EEPROM unlock register](#) is set.

During production, the EEPROM in the TMP119 is programmed with reset values as shown in [表 8-2](#). The [Programming the EEPROM](#) section describes how to change these values. A unique ID is also programmed in the general-purpose EEPROM locations during production. This unique ID is used to support NIST traceability. The TMP119 units are 100% tested on a production setup that is NIST traceable and verified with equipment that is calibrated to ISO/IEC 17025 accredited standards. Only reprogram the general-purpose EEPROM[4:1] locations if NIST traceability is not desired.

#### 7.5.1.2 Programming the EEPROM

To prevent accidental programming, the EEPROM is locked by default. When locked, any I<sup>2</sup>C writes to the register map locations are performed only on the volatile registers and not on the EEPROM.

☒ [7-8](#) shows a flow chart describing the EEPROM programming sequence. To program the EEPROM, first unlock the EEPROM by setting the EUN bit in the [EEPROM unlock register](#). After the EEPROM is unlocked, any subsequent I<sup>2</sup>C writes to the register map locations program a corresponding non-volatile memory location in the EEPROM. Programming a single location typically takes 7ms to complete and consumes 230μA. Do not perform any I<sup>2</sup>C writes until programming is complete. During programming, the EEPROM\_busy flag is set. Read this flag to monitor if the programming is complete. After programming the desired data, issue a general-call reset command to trigger a software reset. The programmed data from the EEPROM are then loaded to the corresponding register map locations as part of the reset sequence. This command also clears the EUN bit and automatically locks the EEPROM to prevent any further accidental programming. Avoid using the device to perform temperature conversions when the EEPROM is unlocked.



図 7-8. EEPROM Programming Sequence

## 7.5.2 Pointer Register

Figure 7-9 shows the internal register structure of the TMP119. The 8-bit pointer register of the device is used to address a given data register. The reset value is 00.

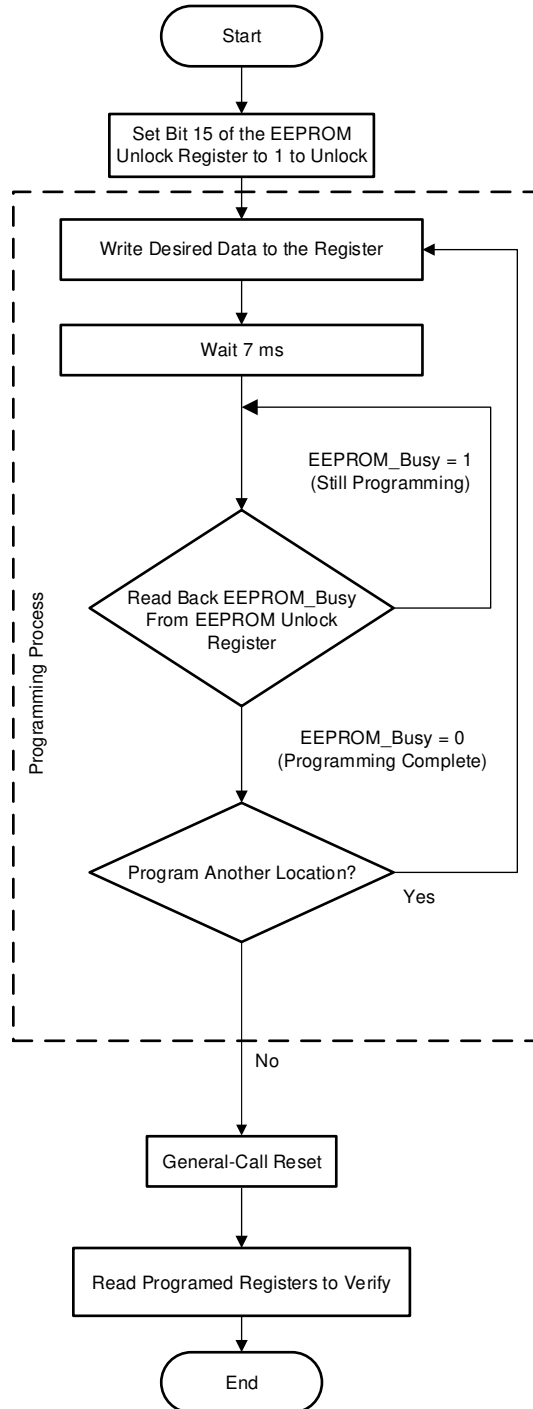
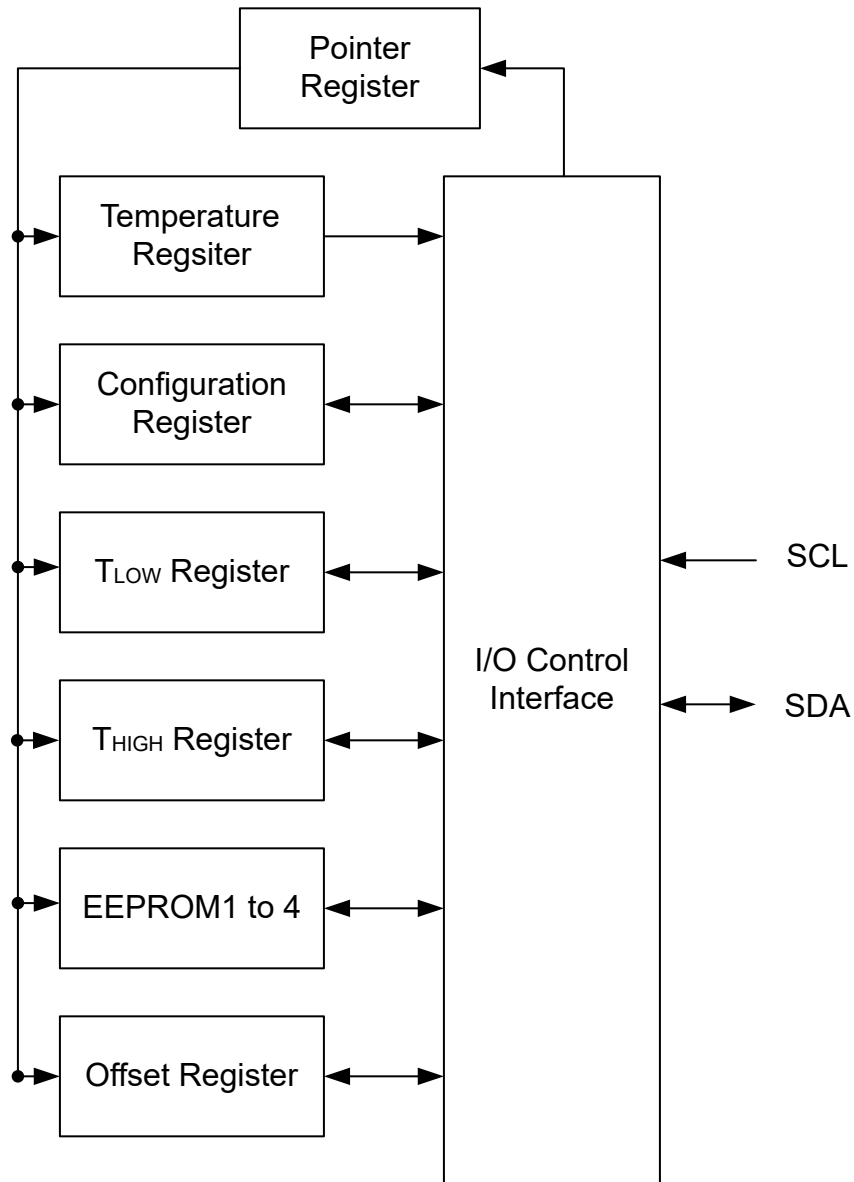

Figure 7-9. Internal Register Structures

## 7.5.3 I<sup>2</sup>C and SMBus Interface

### 7.5.3.1 Serial Interface

The TMP119 operates as a target device only on the two-wire, SMBus and I<sup>2</sup>C interface-compatible bus. Connections to the bus are made through the open-drain I/O lines, the SDA and SCL pins. The SDA and SCL pins feature integrated spike-suppression filters and Schmitt triggers to minimize the effects of input spikes and bus noise. The device supports the transmission protocol for fast (1kHz to 400kHz) mode. Register bytes are sent with the most significant byte first, followed by the least significant byte.

### 7.5.3.1.1 Bus Overview

The device that initiates the transfer is called a *controller*, and the devices controlled by the controller are *targets*. The bus must be controlled by a controller device that generates the serial clock (SCL), controls the bus access, and generates the START and STOP conditions.

To address a specific device, a START condition is initiated, indicated by pulling the data line (SDA) from a high-to-low-logic level when the SCL pin is high. All targets on the bus shift in the target address byte on the rising edge of the clock, and the last bit indicates whether a read or write operation is intended. During the ninth clock pulse, the addressed target generates an acknowledge and pulls the SDA pin low to respond to the controller.

A data transfer is then initiated and sent over eight clock pulses followed by an acknowledge bit. During the data transfer, the SDA pin must remain stable when the SCL pin is high because any change in the SDA pin when the SCL pin is high is interpreted as a START or STOP signal.

When all data are transferred, the controller generates a repeated START condition or a STOP condition.

- TMP119 will ignore any I<sup>2</sup>C traffic until a START condition is observed
- TMP119 I<sup>2</sup>C state machine resets every time the device sees a STOP condition
- For best precision, TI recommends to avoid I<sup>2</sup>C communication during an active conversion

### 7.5.3.1.2 Serial Bus Address

To communicate with the TMP119, the controller must first address target devices through an address byte. The address byte has seven address bits and a read-write (R/W) bit that indicates the intent of executing a read or write operation.

The TMP119 features an address pin to allow up to four devices to be addressed on a single bus. [表 7-2](#) describes the pin logic levels used to properly connect up to four devices. x represents the read-write (R/  $\bar{W}$ ) bit.

**表 7-2. Address Pin and Target Addresses**

DEVICE TWO-WIRE ADDRESS	ADD0 PIN CONNECTION
1001000x	Ground
1001001x	V+
1001010x	SDA
1001011x	SCL

### 7.5.3.1.3 Writing and Reading Operation

The user can write a register address to the pointer register to access a particular register on the TMP119. The value for the pointer register is the first byte transferred after the target address byte with the R/  $\bar{W}$  bit low. Every write operation to the TMP119 requires a value for the pointer register.

When reading from the TMP119, the last value stored in the pointer register by a write operation is used to determine which register is read during a read operation. To change the register pointer for a read operation, a new value must be written to the pointer register. The user can issue an address byte with the R/  $\bar{W}$  bit low, followed by the pointer register byte to write a new value for the pointer register. No additional data is required. The controller can then generate a START condition and send the target address byte with the R/  $\bar{W}$  bit high to initiate the read command. See [図 7-11](#) for details of this sequence. If repeated reads from the same register are desired, it is not necessary to send the pointer register bytes continuously because the TMP119 retains the pointer register value until the value is changed by the next write operation.

Register bytes are sent with the most significant byte first, followed by the least significant byte.

### 7.5.3.1.4 Target Mode Operations

The TMP119 can operate as a target receiver or target transmitter. As a target device, the TMP119 never drives the SCL line.

#### 7.5.3.1.4.1 Target Receiver Mode

The first byte transmitted by the controller is the target address with the  $R/\overline{W}$  bit low. The TMP119 then acknowledges reception of a valid address. The next byte transmitted by the controller is the pointer register. The TMP119 then acknowledges reception of the pointer register byte. The next byte(s) are written to the register addressed by the pointer register. The TMP119 acknowledges reception of each data byte. The controller can terminate data transfer by generating a START or STOP condition.

#### 7.5.3.1.4.2 Target Transmitter Mode

The first byte transmitted by the controller is the target address with the  $R/\overline{W}$  bit high. The target acknowledges reception of a valid target address. The next byte is transmitted by the target and is the most significant byte of the register indicated by the pointer register. The controller acknowledges reception of the data byte. The next byte transmitted by the target is the least significant byte. The controller acknowledges reception of the data byte. The controller can terminate data transfer by generating a *not-acknowledge* on reception of any data byte or by generating a START or STOP condition.

#### 7.5.3.1.5 SMBus Alert Function

The TMP119 supports the SMBus alert function. When the ALERT pin is connected to an SMBus alert signal and a controller senses that an alert condition is present, the controller can send out an SMBus ALERT command (0001 1001) to the bus. If the ALERT pin is active, the device acknowledges the SMBus ALERT command and responds by returning the target address on the SDA line. The eighth bit (LSB) of the target address byte indicates if the alert condition is caused by the temperature exceeding  $T_{(HIGH)}$  or falling below  $T_{(LOW)}$ . The LSB is high if the temperature is greater than  $T_{(HIGH)}$ , or low if the temperature is less than  $T_{(LOW)}$ . See [Figure 7-12](#) for details of this sequence.

In the event that the device with the lowest I<sup>2</sup>C address in continuous conversion mode sees an alert, the controller can temporarily disable Alert mode in this device until all alerts in the system are cleared to prevent this device from blocking other devices with higher I<sup>2</sup>C addresses from reporting to the controller.

If multiple devices on the bus respond to the SMBus ALERT command, arbitration during the target address portion of the SMBus ALERT command determines which device clears the alert status of that device. The device with the lowest two-wire address wins the arbitration. If the TMP119 wins the arbitration, the TMP119 ALERT pin becomes inactive at the completion of the SMBus ALERT command. If the TMP119 loses the arbitration, the TMP119 ALERT pin remains active.

#### 7.5.3.1.6 General-Call Reset Function

The TMP119 responds to a two-wire, general-call address (0000 000) if the eighth bit is 0. The device acknowledges the general-call address and responds to commands in the second byte. If the second byte is 0000 0110, the TMP119 internal registers are reset to power-up values.

#### 7.5.3.1.7 Timeout Function

The TMP119 resets the serial interface if the SCL line is held low by the controller or the SDA line is held low by the TMP119 for 35ms (typical) between a START and STOP condition. The TMP119 releases the SDA line if the SCL pin is pulled low and waits for a START condition from the host controller. To avoid activating the timeout function, maintain a communication speed of at least 1kHz for the SCL operating frequency.

#### 7.5.3.1.8 Timing Diagrams

The TMP119 is two-wire, SMBus and I<sup>2</sup>C interface-compatible. [Figure 7-10](#) to [Figure 7-13](#) show the various operations with the TMP119. Bus definitions are:

**Bus Idle:** Both SDA and SCL lines remain high.

**Start Data Transfer:** A change in the state of the SDA line from high to low when the SCL line is high defines a START condition. Each data transfer is initiated with a START condition.

**Stop Data Transfer:** A change in the state of the SDA line from low to high when the SCL line is high defines a STOP condition. Each data transfer is terminated with a repeated START or STOP condition.



**Data Transfer:** The number of data bytes transferred between a START and a STOP condition is not limited and is determined by the controller device.

**Acknowledge:** Each receiving device, when addressed, is obliged to generate an acknowledge bit. A device that acknowledges must pull down the SDA line during the acknowledge clock pulse in such a way that the SDA line is stable low during the high period of the acknowledge clock pulse. The user must take setup and hold times into account. On a controller receive, the termination of the data transfer can be signaled by the controller generating a *not-acknowledge* (1) on the last byte transmitted by the target.

- Controller controls SDA line
- Target controls SDA line

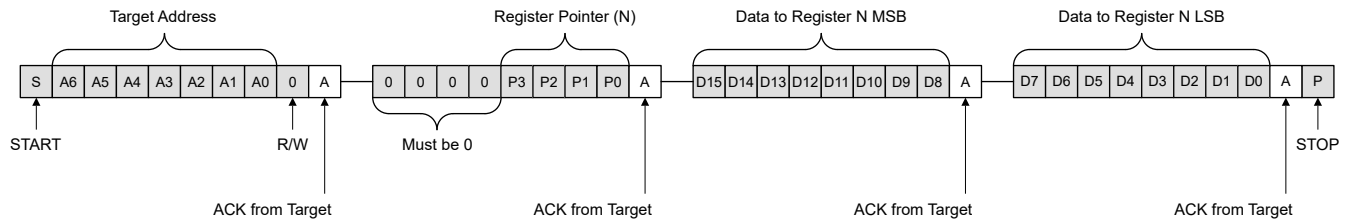

7-10. Write Word Command Timing Diagram

- Controller controls SDA line
- Target controls SDA line

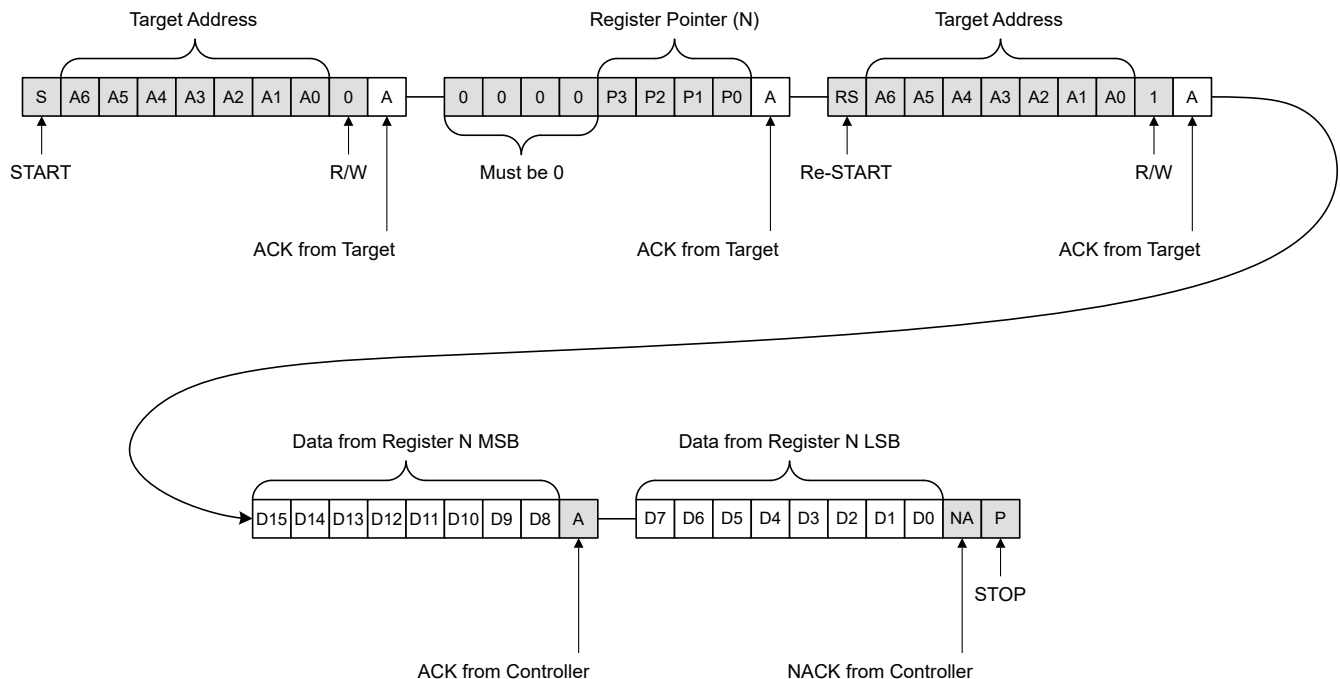

7-11. Read Word Command Timing Diagram

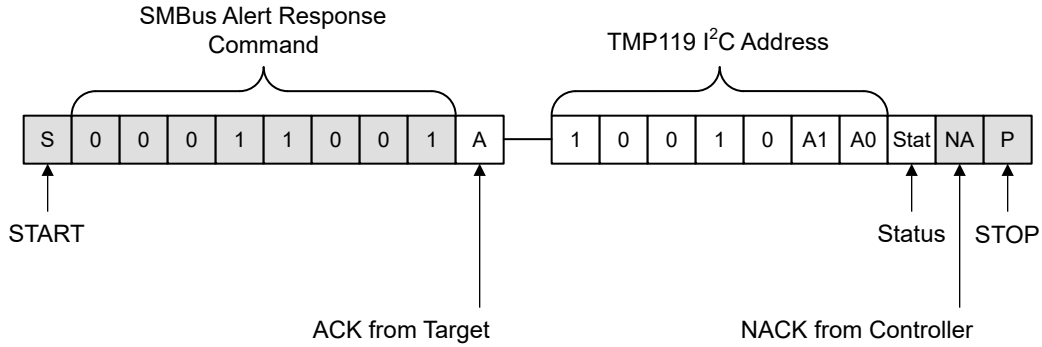
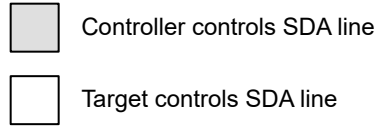

7-12. SMBus ALERT Timing Diagram

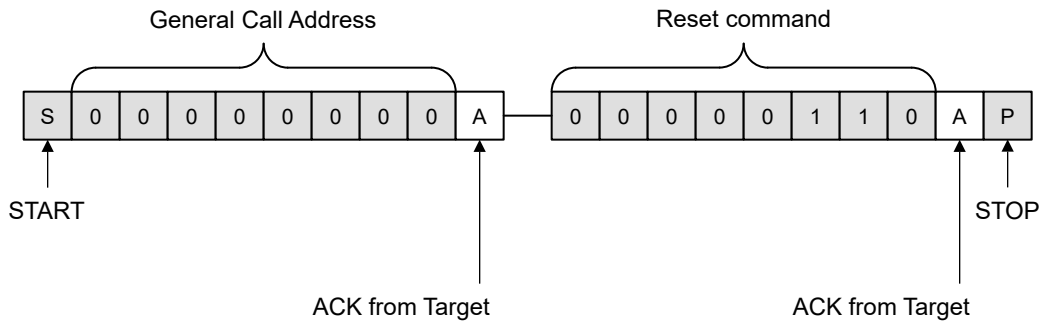
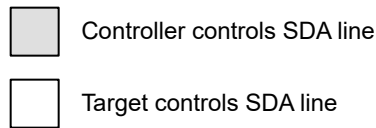

7-13. General-Call Reset Command Timing Diagram

## 8 Application and Implementation

### 注

Information in the following applications sections is not part of the TI component specification, and TI does not warrant its accuracy or completeness. TI's customers are responsible for determining suitability of components for their purposes, as well as validating and testing their design implementation to confirm system functionality.

### 8.1 Application Information

The TMP119 is used to measure the temperature of the board location where the device is mounted. The programmable address options allow up to four locations on the board to be monitored on a single serial bus. For more information, refer to the related [Considerations for Measuring Ambient Air Temperature](#) (SNOA966), [Replacing resistance temperature detectors with the TMP116 temp sensor](#) (SNOA969), and [Temperature sensors: PCB guidelines for surface mount devices](#) (SNOA967) application reports on ti.com.

#### 8.1.1 C-Code Decoding Temperature Data

The TMP119 temperature registers use a 16-bit format. Temperature data is represented by a 16-bit 2's complement word with a Least Significant Bit (LSB) equal to 0.0078125°C. The temperature output of the TMP119 has a range of -256°C to 255°C. The fractional values are included in the temperature readings, which can be denoted using Q notation, a simple way to represent the length of the fractional portion of the value. 2's Compliment is employed to describe negative temperatures. C code can easily convert the 2's Compliment data when the data is typecast into the correct signed data type.

図 8-1. Encoding Parameters

Parameter	Value
Bits	16
Q	7
Resolution	0.0078125
Range (+)	255.9921875
Range (-)	-256
25°C	0xC80

表 8-1. 16-Bit Q Notation Bit Weights

15	14	13	12	11	10	9	8	7	6	5	4	3	2	1	0
Sign	128	64	32	16	8	4	2	1	0.5	0.25	0.125	0.0625	0.03125	0.015625	0.0078125
-256	128	64	32	16	8	4	2	1	1/2	1/4	1/8	1/16	1/32	1/64	1/128
-2 <sup>8</sup>	2 <sup>7</sup>	2 <sup>6</sup>	2 <sup>5</sup>	2 <sup>4</sup>	2 <sup>3</sup>	2 <sup>2</sup>	2 <sup>1</sup>	2 <sup>0</sup>	2 <sup>-1</sup>	2 <sup>-2</sup>	2 <sup>-3</sup>	2 <sup>-4</sup>	2 <sup>-5</sup>	2 <sup>-6</sup>	2 <sup>-7</sup>

```
C Code Examples:
/* 16-bit format will have 0 bits discarded by right shift
q7 is 0.0078125 resolution
the following bytes represent 24.5C */
uint8_t byte1 = 0xC;
uint8_t byte2 = 0x40;
float f = ((int8_t) byte1 << 8 | byte2) * 0.0078125f;
int mC = ((int8_t) byte1 << 8 | byte2) * 1000 >> 7;
int c = ((int8_t) byte1 << 8 | byte2) >> 7;
```

## 8.2 Typical Application



図 8-2. Typical Connections

### 8.2.1 Design Requirements

The TMP119 operates only as a target device and communicates with the host through the I<sup>2</sup>C-compatible serial interface. SCL is the input pin, SDA is a bidirectional pin, and ALERT is the output. The TMP119 requires a pullup resistor on the SDA, and ALERT pins. The recommended value for the pullup resistors is 5kΩ. In some applications, the pullup resistor can be lower or higher than 5kΩ. A 0.1μF bypass capacitor is recommended to be connected between V+ and GND. An SCL pullup resistor is required if the system microprocessor SCL pin is open-drain. Use a ceramic capacitor type with a temperature rating that matches the operating range of the application, and place the capacitor as close as possible to the V+ pin of the TMP119. The ADD0 pin can be connected directly to GND, V+, SDA and SCL for address selection of four possible unique target ID addresses. [表 7-1](#) explains the addressing scheme. The ALERT output pin can be connected to a microcontroller interrupt that triggers an event that occurred when the temperature limit exceeds the programmable value in registers 02h and 03h. The ALERT pin can be left floating or connected to ground when not in use.

## 8.2.2 Detailed Design Procedure

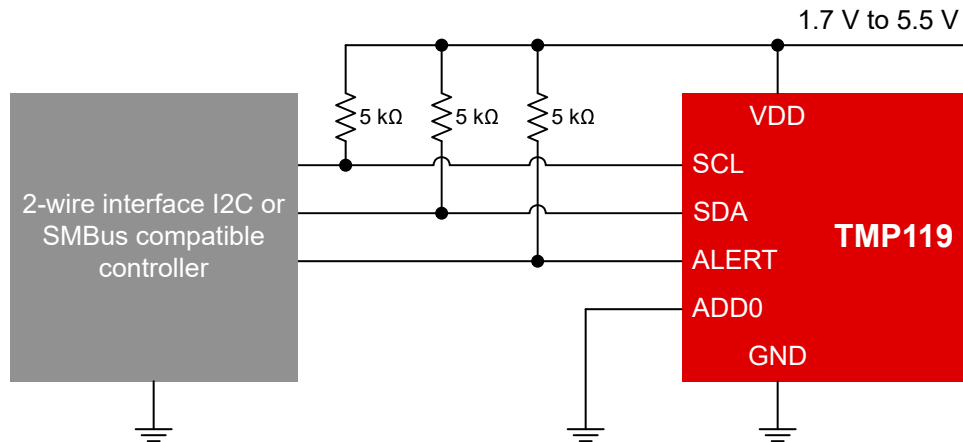
### 8.2.2.1 Noise and Averaging

The device temperature sampling distribution (with averaging disabled) covers an area of approximately six neighboring codes. The noise area of the six codes remains the same at full supply and full temperature range with a standard deviation of approximately 1 LSB. The device provides an averaging tool for 1, 8, 32, or 64 conversions. As shown in [Figure 6-5](#), the 8-sample averaging reduces the internal noise distribution to a theoretical minimum of two LSBs. This averaging means that if the system temperature slowly changes and the supply voltage is stable, then the 8-sample averaging can be enough to neutralize the device noise and provide stable temperature readings. However, if the system environment is noisy (such as when measuring air flow temperatures, power supply fluctuations, intensive communication on a serial bus, and so forth), then higher averaging numbers are recommended to be used.

### 8.2.2.2 Self-Heating Effect (SHE)

During ADC conversion, some power is dissipated that heats the device despite the small power consumption of the TMP119. Consider the self-heating effect (SHE) for certain precise measurements. [Figure 8-3](#) shows the device SHE in still air at 25°C after the supply is switched on. The device package is soldered to the 11mm × 20mm × 0.7mm size coupon board. The board is placed horizontally, with the device on top. The TMP119 is in continuous conversion mode with 64 sampling averaging and zero conversion cycle time. There is no digital bus activity aside from reading temperature data one time each second. As shown in [Figure 8-3](#), the SHE stabilization time in still air is greater when the device dissipates more power.

The SHE drift is strongly proportional to the device dissipated power. The SHE drift is also proportional to the device temperature because the consumption current with the same supply voltage increases with temperature. [Figure 8-4](#) shows the SHE drifts versus temperature and dissipated power at 25 °C for the same coupon board and the same conditions described previously.

To estimate the SHE for similar size boards, calculate the device consumption power for 25°C and use the corresponding power line shown in [Figure 8-4](#).

The following methods can reduce the SHE:

- System calibration removes not only the self-heating error and power-supply rejection ratio (PSRR) effect but also compensates the temperature shift caused by the thermal resistance between the device and the measured object.
- If practical, use the device one-shot mode. If continuous conversion is needed, use the conversion cycle mode with significant standby time. For example, in most cases an 8-sample averaging (125ms) with a 1-second conversion cycle provides enough time for the device to cool down to the environment temperature and removes the SHE.
- Use the minimal acceptable power supply voltage.
- Use a printed-circuit board (PCB) layout that provides minimal thermal resistance to the device.
- Avoid using small-value pullup resistors on the SDA and ALERT pins. Instead, use pullup resistors larger than 2kΩ.
- Ensure that the SCL and SDA signal levels remain below 10% or above 90% of the device supply voltage.
- Avoid heavy bypass traffic on the data line. Communication to other devices on the same data line increases the supply current even if the device is in SD mode.
- Use the highest available communication speed.

### 8.2.2.3 Synchronized Temperature Measurements

When four temperature measurements are needed in four different places simultaneously, triggering a reset is recommended. In this method, four devices are programmed with control registers set to CC mode with a conversion cycle time of 16s. All four devices are connected to same two-wire bus with four different bus addresses. The bus general-call reset command is issued by the controller. This command triggers all devices to reset (which takes approximately 1.5ms) and triggers a simultaneous temperature sampling according to configuration registers setting. The controller has 16 seconds to read data from the devices.

### 8.2.3 Application Curves

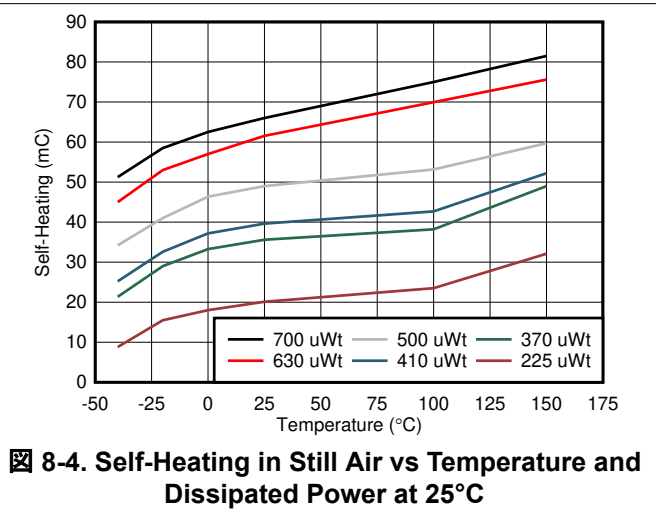
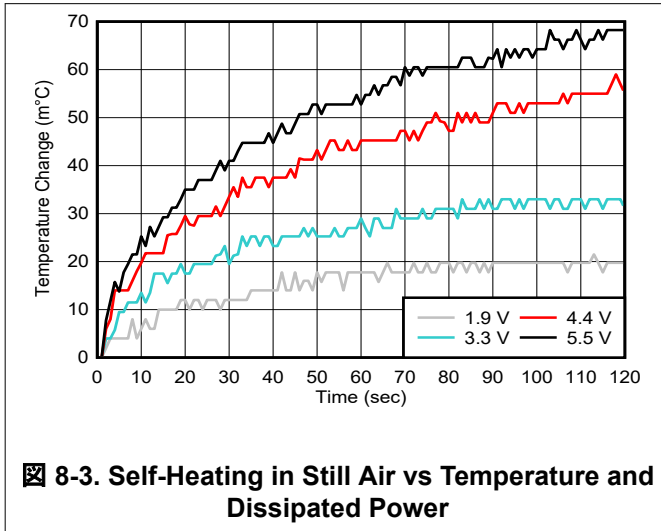

### 8.3 Power Supply Recommendations

The TMP119 operates on a power-supply range from 1.7V to 5.5V. A power-supply bypass capacitor is required, which must be placed as close to the supply and ground pins of the device as possible. A recommended value for this supply bypass capacitor is 100nF. Applications with noisy or high-impedance power supplies may require additional decoupling capacitors to reject power-supply noise.

### 8.4 Layout

#### 8.4.1 Layout Guidelines

For more information on board layout, refer to the related [Precise temperature measurements with TMP116 and TMP117](#) (SNOA986) and [Wearable temperature-sensing layout considerations optimized for thermal response](#) (SNIA021) application reports on ti.com.

Place the power-supply bypass capacitor as close as possible to the supply and ground pins. The recommended value of this bypass capacitor is 0.1μF. In some cases, the pullup resistor can be the heat source, therefore, maintain some distance between the resistor and the device.

1. If the device is used to measure solid surface temperature:
  - Use PCB with minimal thickness.
  - Prevent PCB bending which can create a mechanical stress to package.
  - Cover bottom of the PCB with copper plane.
  - Remove bottom solder mask and cover exposed copper with gold layer if possible.
  - Use thermal conductive paste between PCB and object surface.
  - If PCB has unused internal layers, extend these layers under the sensor.
  - Minimize amount of copper wires on top of the board.
  - To minimize temperature “leakage” to surrounding air locate sensor in place with minimal air movement. Horizontal surfaces are preferable.
  - To minimize temperature offset due to “leakage” to surrounding air cover sensor with thermo isolating foam, tape or at least cover with a stain.
2. If the device is used to measure moving air temperature:
  - Because moving air temperature usually has a lot of fluctuations the PCB increased thermal mass reduces measurement noise.
  - Use a PCB with thicker copper layers if possible.
  - Cover both side of unused board space with copper layer.
  - Place PCB vertically along air flow.

3. If the device is used to measure still air temperature:
  - Miniaturize the board to reduce thermal mass. Smaller thermal mass results in faster thermal response.
  - Remove the top solder mask.
  - To prevent oxidation, cover any exposed copper with solder paste.
  - Thermal isolation is required to avoid thermal coupling from heat source components through the PCB.
  - Avoid running the copper plane underneath the temperature sensor.
  - Maximize the air gap between the sensor and the surrounding copper areas (anti-etch), especially when close to the heat source.
  - Create a PCB cutout between sensor and other circuits. Leave a narrow channel away from heat source components as a routing bridge into the island.
  - If the heat source is top side, avoid running traces on top; instead, route all signals on the bottom side.
  - Place the board vertically to improve air flow and to reduce dust collection.

### 8.4.2 Layout Example



図 8-5. YBG Layout Recommendation

## 8.5 Register Map

表 8-2. TMP119 Register Map

ADDRESS	TYPE	RESET	ACRONYM	REGISTER NAME	SECTION
00h	R	8000h	Temp_Result	Temperature result register	<a href="#">Go</a>
01h	R/W	0220h <sup>(1)</sup>	Configuration	Configuration register	<a href="#">Go</a>
02h	R/W	6000h <sup>(1)</sup>	THigh_Limit	Temperature high limit register	<a href="#">Go</a>
03h	R/W	8000h <sup>(1)</sup>	TLow_Limit	Temperature low limit register	<a href="#">Go</a>
04h	R/W	0000h	EEPROM_UL	EEPROM unlock register	<a href="#">Go</a>
05h	R/W	xxxxh <sup>(1)</sup>	EEPROM1	EEPROM1 register	<a href="#">Go</a>
06h	R/W	xxxxh <sup>(1)</sup>	EEPROM2	EEPROM2 register	<a href="#">Go</a>
07h	R/W	0000h <sup>(1)</sup>	Temp_Offset	Temperature offset register	<a href="#">Go</a>
08h	R/W	xxxxh <sup>(1)</sup>	EEPROM3	EEPROM3 register	<a href="#">Go</a>
0Fh	R	0117h	Device_ID	Device ID register	<a href="#">Go</a>

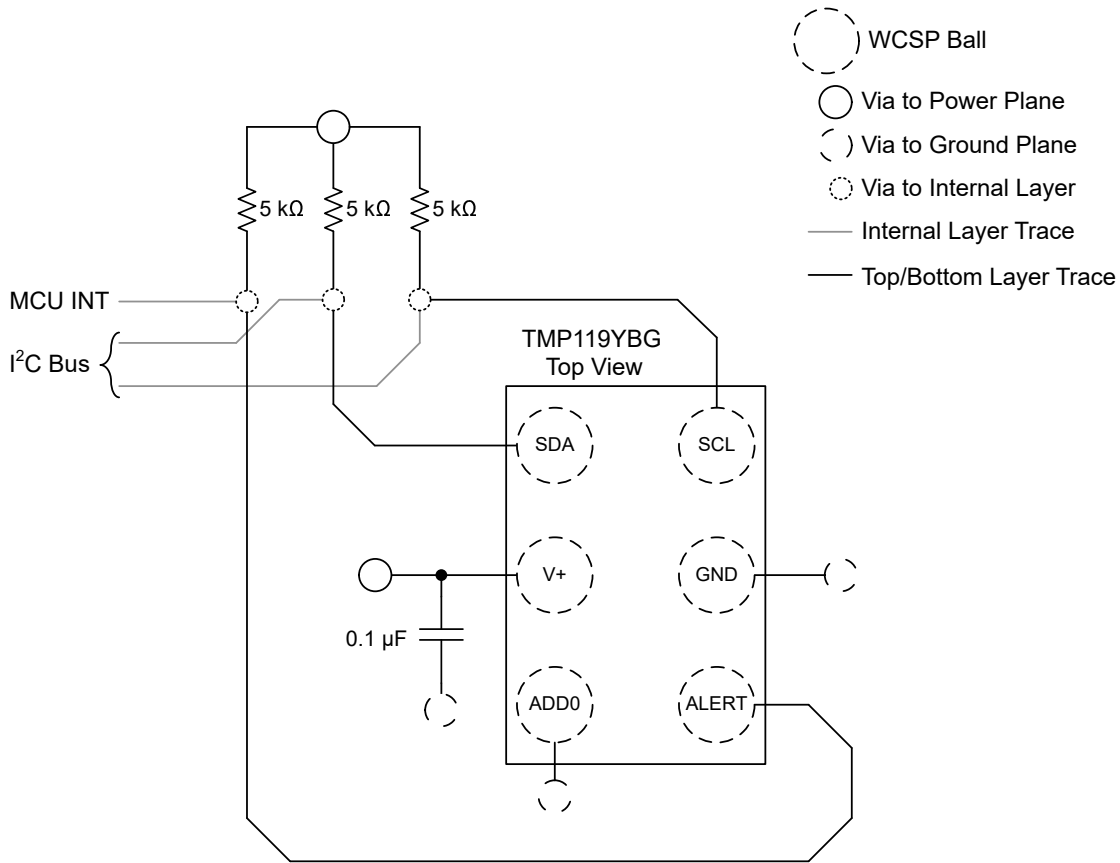
- (1) This value is stored in Electrically-Erasable, Programmable Read-Only Memory (EEPROM) during device manufacturing. The device reset value can be changed by writing the relevant code in the EEPROM cells (see the [EEPROM Overview](#) section).

表 8-3. TMP119 Access Type Codes

Access Type	Code	Description
Read Type		
R	R	Read
RC	R C	Read to Clear
Write Type		
W	W	Write
Reset or Default Value		
-n		Value after reset or the default value



### 8.5.1 Register Descriptions

#### 8.5.2 Temperature Register (address = 00h) [default reset = 8000h]

This register is a 16-bit, read-only register that stores the output of the most recent conversion. One LSB equals 7.8125m°C. Data are represented in binary 2's complement format. Following a reset, the temperature register reads –256°C until the first conversion, including averaging, is complete. See the [Power Up](#) section for more information.

Return to [Register Map](#).

**図 8-6. Temperature Register**

15	14	13	12	11	10	9	8
T15	T14	T13	T12	T11	T10	T9	T8
R-1	R-0	R-0	R-0	R-0	R-0	R-0	R-0
7	6	5	4	3	2	1	0
T7	T6	T5	T4	T3	T2	T1	T0
R-0	R-0	R-0	R-0	R-0	R-0	R-0	R-0

**表 8-4. Temperature Register Field Descriptions**

BIT	FIELD	TYPE	RESET	DESCRIPTION
15:0	T[15:0]	R	8000h	16-bit, read-only register that stores the most recent temperature conversion results in 2's complement format.

### 8.5.3 Configuration Register (address = 01h) [factory default reset = 0220h]

Return to [Register Map](#).

**図 8-7. Configuration Register**

15	14	13	12	11	10	9	8
HIGH_Alert	LOW_Alert	Data_Ready	EEPROM_Busy	MOD1 <sup>(2)</sup>	MOD0 <sup>(1)</sup>	CONV2 <sup>(1)</sup>	CONV1 <sup>(1)</sup>
R-0	R-0	R-0	R-0	R/W-0	R/W-0	R/W-1	R/W-0
7	6	5	4	3	2	1	0
CONV0 <sup>(1)</sup>	AVG1 <sup>(1)</sup>	AVG0 <sup>(1)</sup>	T/nA <sup>(1)</sup>	POL <sup>(1)</sup>	DR/Alert <sup>(1)</sup>	Soft_Reset	—
R/W-0	R/W-0	R/W-1	R/W-0	R/W-0	R/W-0	R-0	R-0

**表 8-5. Configuration Register Field Descriptions**

BIT	FIELD	TYPE	RESET	DESCRIPTION
15	HIGH_Alert	R	0	High Alert flag: 1: Set when the conversion result is higher than the high limit 0: Cleared on read of configuration register Therm mode: 1: Set when the conversion result is higher than the therm limit 0: Cleared when the conversion result is lower than the hysteresis
14	LOW_Alert	R	0	Low Alert flag: 1: Set when the conversion result is lower than the low limit 0: Cleared when the configuration register is read Therm mode: Always set to 0
13	Data_Ready	R	0	Data ready flag. This flag indicates that the conversion is complete and the temperature register can be read. Every time the temperature register or configuration register is read, this bit is cleared. This bit is set at the end of the conversion when the temperature register is updated. Data ready can be monitored on the ALERT pin by setting bit 2 of the configuration register.
12	EEPROM_Busy	R	0	EEPROM busy flag. The value of the flag indicates that the EEPROM is busy during programming or power-up.
11:10	MOD[1:0]	R/W	0	Set conversion mode. 00: Continuous conversion (CC) 01: Shutdown (SD) 10: Continuous conversion (CC), Same as 00 (reads back = 00) 11: One-shot conversion (OS)
9:7	CONV[2:0]	R/W	100	Conversion cycle bit. See <a href="#">表 8-6</a> for the standby time between conversions.
6:5	AVG[1:0]	R/W	01	Conversion averaging modes. Determines the number of conversion results that are collected and averaged before updating the temperature register. The average is an accumulated average and not a running average. 00: No averaging 01: 8 Averaged conversions 10: 32 averaged conversions 11: 64 averaged conversions
4	T/nA	R/W	0	Therm/alert mode select. 1: Therm mode 0: Alert mode
3	POL	R/W	0	ALERT pin polarity bit. 1: Active high 0: Active low
2	DR/Alert	R/W	0	ALERT pin select bit. 1: ALERT pin reflects the status of the data ready flag 0: ALERT pin reflects the status of the alert flags

**表 8-5. Configuration Register Field Descriptions (続き)**

BIT	FIELD	TYPE	RESET	DESCRIPTION
1	Soft_Reset	R/W	0	Software reset bit. When set to 1, this bit triggers a software reset with a duration of 2ms This bit will always read back 0
0	—	R	0	Not used

- (1) These bits can be stored in EEPROM. The factory setting for this register is 0220.
- (2) The MOD1 bit cannot be stored in EEPROM. The device can only be programmed to start up in shutdown mode or continuous conversion mode.

**表 8-6. Conversion Cycle Time in CC Mode**

CONV[2:0]	AVG[1:0] = 00	AVG[1:0] = 01	AVG[1:0] = 10	AVG[1:0] = 11
000	15.5ms	125ms	500ms	1s
001	125ms	125ms	500ms	1s
010	250ms	250ms	500ms	1s
011	500ms	500ms	500ms	1s
100	1s	1s	1s	1s
101	4s	4s	4s	4s
110	8s	8s	8s	8s
111	16s	16s	16s	16s

If the time to complete the conversions needed for a given averaging setting is higher than the conversion setting cycle time, there will be no stand by time in the conversion cycle.

### 8.5.4 High Limit Register (address = 02h) [Factory default reset = 6000h]

This register is a 16-bit, read/write register that stores the high limit for comparison with the temperature result. One LSB equals 7.8125m°C. The range of the register is ±256°C. Negative numbers are represented in binary 2's complement format. Following power-up or a general-call reset, the high-limit register is loaded with the stored value from the EEPROM. The factory default reset value is 6000h.

Return to [Register Map](#).

図 8-8. High Limit Register

15	14	13	12	11	10	9	8
H15	H14	H13	H12	H11	H10	H9	H8
R/W-0	R/W-1	R/W-1	R/W-0	R/W-0	R/W-0	R/W-0	R/W-0
7	6	5	4	3	2	1	0
H7	H6	H5	H4	H3	H2	H1	H0
R/W-0	R/W-0	R/W-0	R/W-0	R/W-0	R/W-0	R/W-0	R/W-0

表 8-7. High Limit Register Field Descriptions

BIT	FIELD	TYPE	RESET	DESCRIPTION
15:0	H[15:0]	R/W	6000h	16-bit, read/write register that stores the high limit for comparison with the temperature result.

### 8.5.5 Low Limit Register (address = 03h) [Factory default reset = 8000h]

This register is configured as a 16-bit, read/write register that stores the low limit for comparison with the temperature result. One LSB equals 7.8125m°C. The range of the register is ±256°C. Negative numbers are represented in binary 2's complement format. The data format is the same as the temperature register. Following power-up or reset, the low-limit register is loaded with the stored value from the EEPROM. The factory default reset value is 8000h.

Return to [Register Map](#).

図 8-9. Low Limit Register

15	14	13	12	11	10	9	8
L15	L14	L13	L12	L11	L10	L9	L8
R/W-1	R/W-0	R/W-0	R/W-0	R/W-0	R/W-0	R/W-0	R/W-0
7	6	5	4	3	2	1	0
L7	L6	L5	L4	L3	L2	L1	L0
R/W-0	R/W-0	R/W-0	R/W-0	R/W-0	R/W-0	R/W-0	R/W-0

表 8-8. Low Limit Register Field Descriptions

BIT	FIELD	TYPE	RESET	DESCRIPTION
15:0	L[15:0]	R/W	8000h	16-bit, read/write register that stores the low limit for comparison with the temperature result.

### 8.5.6 EEPROM Unlock Register (address = 04h) [reset = 0000h]

Return to [Register Map](#).

図 8-10. EEPROM Unlock Register

15	14	13	12	11	10	9	8
EUN	EEPROM_Busy	—	—	—	—	—	—
R/W-0	R-0	R-0	R-0	R-0	R-0	R-0	R-0
7	6	5	4	3	2	1	0
—	—	—	—	—	—	—	—
R-0	R-0	R-0	R-0	R-0	R-0	R-0	R-0

表 8-9. EEPROM Unlock Register Field Descriptions

BIT	FIELD	TYPE	RESET	DESCRIPTION
15	EUN	R/W	0	EEPROM unlock. 0: EEPROM is locked for programming: writes to all EEPROM addresses (such as configuration, limits, and EEPROM locations 1-4) are written to registers in digital logic and are not programmed in the EEPROM 1: EEPROM unlocked for programming: any writes to programmable registers program the respective location in the EEPROM
14	EEPROM_Busy	R	0	EEPROM busy. This flag is the mirror of the EEPROM busy flag (bit 12) in the configuration register. 0: Indicates that the EEPROM is ready, which means that the EEPROM has finished the last transaction and is ready to accept new commands 1: Indicates that the EEPROM is busy, which means that the EEPROM is currently completing a programming operation or performing power-up on reset load
13:0	—	R	0	Not used

### 8.5.7 EEPROM1 Register (address = 05h) [reset = XXXXh]

The EEPROM1 register is a 16-bit register that be used as a scratch pad by the customer to store general-purpose data. This register has a corresponding EEPROM location. Writes to this address when the EEPROM is locked write data into the register and not to the EEPROM. Writes to this register when the EEPROM is unlocked causes the corresponding EEPROM location to be programmed. See the [Programming the EEPROM](#) section for more information. EEPROM[4:1] are preprogrammed during manufacturing with the unique ID that can be overwritten. To support NIST traceability do not delete or reprogram the EEPROM[1] register.

Return to [Register Map](#).

図 8-11. EEPROM1 Register

15	14	13	12	11	10	9	8
D15	D14	D13	D12	D11	D10	D9	D8
R/W-x	R/W-x	R/W-x	R/W-x	R/W-x	R/W-x	R/W-x	R/W-x
7	6	5	4	3	2	1	0
D7	D6	D5	D4	D3	D2	D1	D0
R/W-x	R/W-x	R/W-x	R/W-x	R/W-x	R/W-x	R/W-x	R/W-x

**表 8-10. EEPROM1 Register Field Descriptions**

BIT	FIELD	TYPE	RESET	DESCRIPTION
15:0	D[15:0]	R/W	xxxxh	This 16-bit register can be used as a scratch pad. To support NIST traceability do not delete or re-program this register.

### 8.5.8 EEPROM2 Register (address = 06h) [reset = 0000h]

This register function the same as the EEPROM1 register.

Return to [Register Map](#).

**図 8-12. EEPROM2 Register**

15	14	13	12	11	10	9	8
D15	D14	D13	D12	D11	D10	D9	D8
R/W-x	R/W-x	R/W-x	R/W-x	R/W-x	R/W-x	R/W-x	R/W-x
7	6	5	4	3	2	1	0
D7	D6	D5	D4	D3	D2	D1	D0
R/W-x	R/W-x	R/W-x	R/W-x	R/W-x	R/W-x	R/W-x	R/W-x

**表 8-11. EEPROM2 Register Field Descriptions**

BIT	FIELD	TYPE	RESET	DESCRIPTION
15:0	D[15:0]	R/W	xxxxh	This 16-bit register can be used as a scratch pad.

### 8.5.9 Temperature Offset Register (address = 07h) [reset = 0000h]

Use this 16-bit register as a user-defined temperature offset register during system calibration. The offset will be added to the temperature result after linearization. This register has a same resolution of 7.8125m°C and the same range of  $\pm 256^{\circ}\text{C}$  as the temperature result register. The data format is the same as the temperature register. If the added result is out of boundary, then the temperature result will show as the maximum or minimum value.

Return to [Register Map](#).

**図 8-13. Temperature Offset Register**

15	14	13	12	11	10	9	8
D15	D14	D13	D12	D11	D10	D9	D8
R/W-0	R/W-0	R/W-0	R/W-0	R/W-0	R/W-0	R/W-0	R/W-0
7	6	5	4	3	2	1	0
D7	D6	D5	D4	D3	D2	D1	D0
R/W-0	R/W-0	R/W-0	R/W-0	R/W-0	R/W-0	R/W-0	R/W-0

**表 8-12. Temperature Offset Register Field Descriptions**

BIT	FIELD	TYPE	RESET	DESCRIPTION
15:0	D[15:0]	R/W	0	Temperature offset data from system calibration.

### 8.5.10 EEPROM3 Register (address = 08h) [reset = xxxh]

This register function is the same as the EEPROM1 register. To support NIST traceability, do not delete or reprogram the EEPROM[1] register.

Return to [Register Map](#).

☒ 8-14. EEPROM3 Register

15	14	13	12	11	10	9	8
D15	D14	D13	D12	D11	D10	D9	D8
R/W-x	R/W-x	R/W-x	R/W-x	R/W-x	R/W-x	R/W-x	R/W-x
7	6	5	4	3	2	1	0
D7	D6	D5	D4	D3	D2	D1	D0
R/W-x	R/W-x	R/W-x	R/W-x	R/W-x	R/W-x	R/W-x	R/W-x

表 8-13. EEPROM3 Register Field Descriptions

BIT	FIELD	TYPE	RESET	DESCRIPTION
15:0	D[15:0]	R/W	xxxh	This 16-bit register is used as a scratch pad. To support NIST traceability, do not delete or re-program this register.

### 8.5.11 Device ID Register (address = 0Fh) [reset = 2117h]

This read-only register indicates the device ID.

Return to [Register Map](#).

☒ 8-15. Device ID Register

15	14	13	12	11	10	9	8
Rev3	Rev2	Rev1	Rev0	DID11	DID10	DID9	DID8
R-0	R-0	R-1	R-0	R-0	R-0	R-0	R-1
7	6	5	4	3	2	1	0
DID7	DID6	DID5	DID4	DID3	DID2	DID1	DID0
R-0	R-0	R-0	R-1	R-0	R-1	R-1	R-1

表 8-14. Device ID Register Field Descriptions

BIT	FIELD	TYPE	RESET	DESCRIPTION
15:12	Rev[3:0]	R	2h	Indicates the revision number.
11:0	DID[11:0]	R	117h	Indicates the device ID.



## 9 Device and Documentation Support

### 9.1 Documentation Support

#### 9.1.1 Related Documentation

For related documentation see the following:

- Texas Instruments, [TMPx75 Temperature Sensor With I<sup>2</sup>C and SMBus Interface in Industry Standard LM75 Form Factor and Pinout data sheet](#)
- Texas Instruments, [TMP275 ±0.5°C Temperature Sensor With I<sup>2</sup>C and SMBus Interface in Industry Standard LM75 Form Factor and Pinout data sheet](#)
- Texas Instruments, [Design Considerations for Measuring Ambient Air Temperature application note](#)
- Texas Instruments, [Replacing Resistance Temperature Detectors with the TMP116 Temp Sensor application note](#)
- Texas Instruments, [Temperature Sensors: PCB Guidelines for Surface Mount Devices application note](#)
- Texas Instruments, [Precise Temperature Measurements With the TMP116 and TMP117 application note](#)
- Texas Instruments, [Wearable Temperature Sensing Layout Considerations Optimized for Thermal Response application note](#)

### 9.2 ドキュメントの更新通知を受け取る方法

ドキュメントの更新についての通知を受け取るには、[www.tij.co.jp](http://www.tij.co.jp) のデバイス製品フォルダを開いてください。[通知] をクリックして登録すると、変更されたすべての製品情報に関するダイジェストを毎週受け取ることができます。変更の詳細については、改訂されたドキュメントに含まれている改訂履歴をご覧ください。

### 9.3 サポート・リソース

テキサス・インスツルメンツ E2E™ サポート・フォーラムは、エンジニアが検証済みの回答と設計に関するヒントをエキスパートから迅速かつ直接得ることができる場所です。既存の回答を検索したり、独自の質問をしたりすることで、設計に必要な支援を迅速に得ることができます。

リンクされているコンテンツは、各寄稿者により「現状のまま」提供されるものです。これらはテキサス・インスツルメンツの仕様を構成するものではなく、必ずしもテキサス・インスツルメンツの見解を反映したものではありません。テキサス・インスツルメンツの[使用条件](#)を参照してください。

### 9.4 Trademarks

SMBus™ is a trademark of Intel Corporation.

テキサス・インスツルメンツ E2E™ is a trademark of Texas Instruments.

すべての商標は、それぞれの所有者に帰属します。

### 9.5 静電気放電に関する注意事項



この IC は、ESD によって破損する可能性があります。テキサス・インスツルメンツは、IC を取り扱う際には常に適切な注意を払うことを推奨します。正しい取り扱いおよび設置手順に従わない場合、デバイスを破損するおそれがあります。

ESD による破損は、わずかな性能低下からデバイスの完全な故障まで多岐にわたります。精密な IC の場合、パラメータがわずかに変化するだけで公表されている仕様から外れる可能性があるため、破損が発生しやすくなっています。

### 9.6 用語集

[テキサス・インスツルメンツ用語集](#) この用語集には、用語や略語の一覧および定義が記載されています。

## 10 Revision History

資料番号末尾の英字は改訂を表しています。その改訂履歴は英語版に準じています。

DATE	REVISION	NOTES
January 2024	*	Initial Release

## 11 Mechanical, Packaging, and Orderable Information

The following pages include mechanical, packaging, and orderable information. This information is the most current data available for the designated devices. This data is subject to change without notice and revision of this document. For browser-based versions of this data sheet, refer to the left-hand navigation.

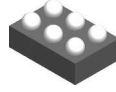

**YBG0006-C01**

**PACKAGE OUTLINE**  
**DSBGA - 0.525 mm max height**

DIE SIZE BALL GRID ARRAY

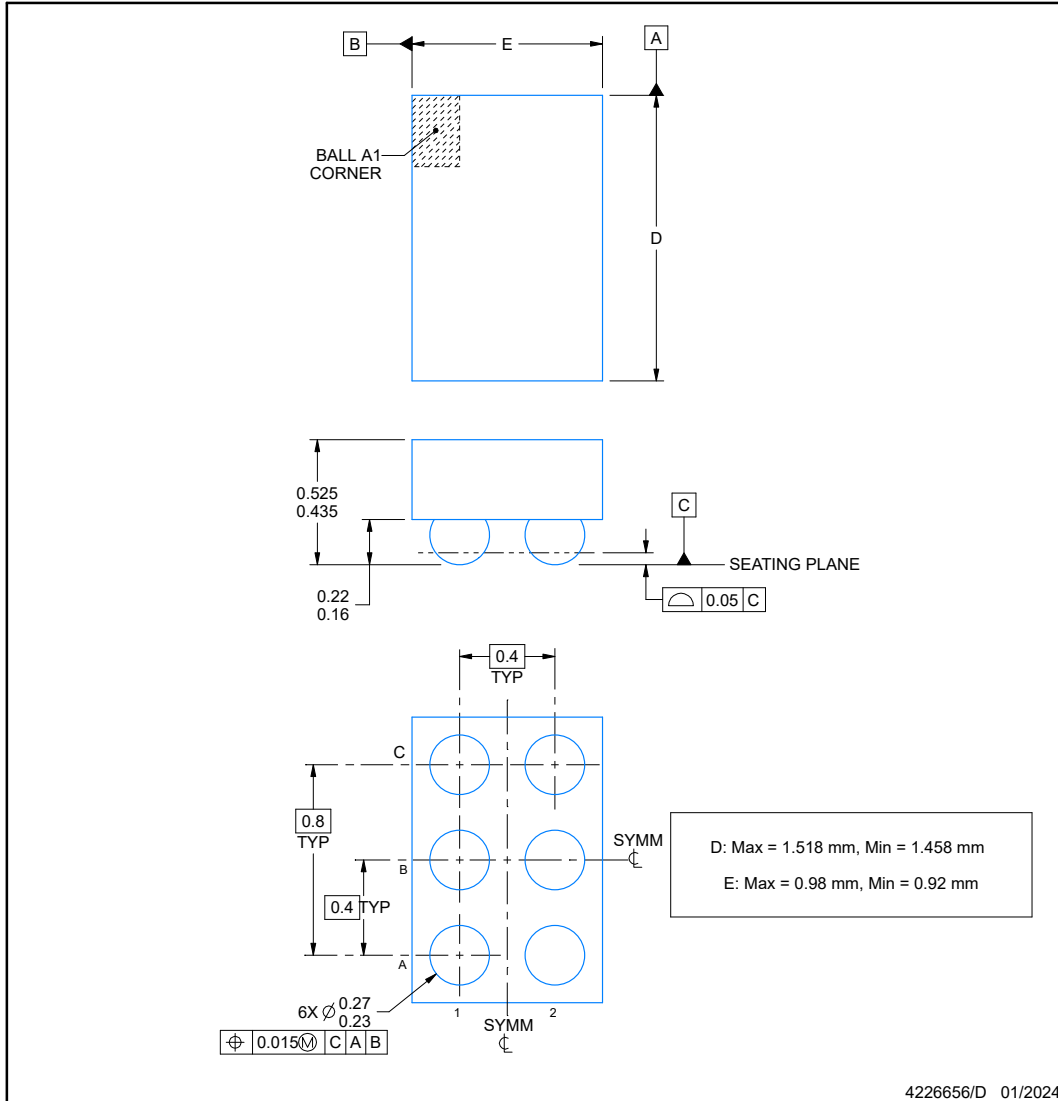

NOTES:

1. All linear dimensions are in millimeters. Any dimensions in parenthesis are for reference only. Dimensioning and tolerancing per ASME Y14.5M.
2. This drawing is subject to change without notice.

## EXAMPLE BOARD LAYOUT

**YBG0006-C01**

**DSBGA - 0.525 mm max height**

DIE SIZE BALL GRID ARRAY

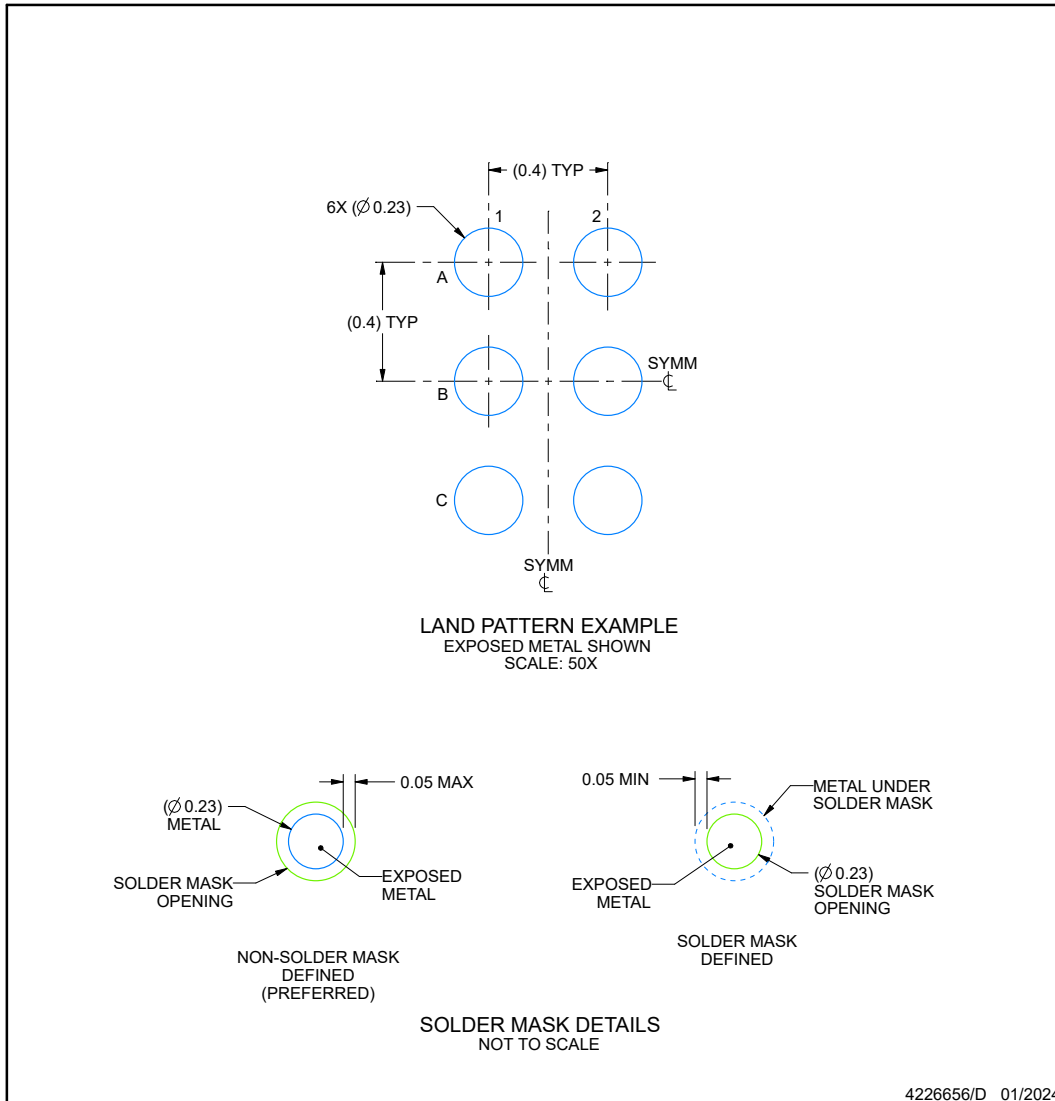

NOTES: (continued)

- Final dimensions may vary due to manufacturing tolerance considerations and also routing constraints. See Texas Instruments Literature No. SNVA009 ([www.ti.com/lit/snva009](http://www.ti.com/lit/snva009)).

## EXAMPLE STENCIL DESIGN

**YBG0006-C01**

**DSBGA - 0.525 mm max height**

DIE SIZE BALL GRID ARRAY

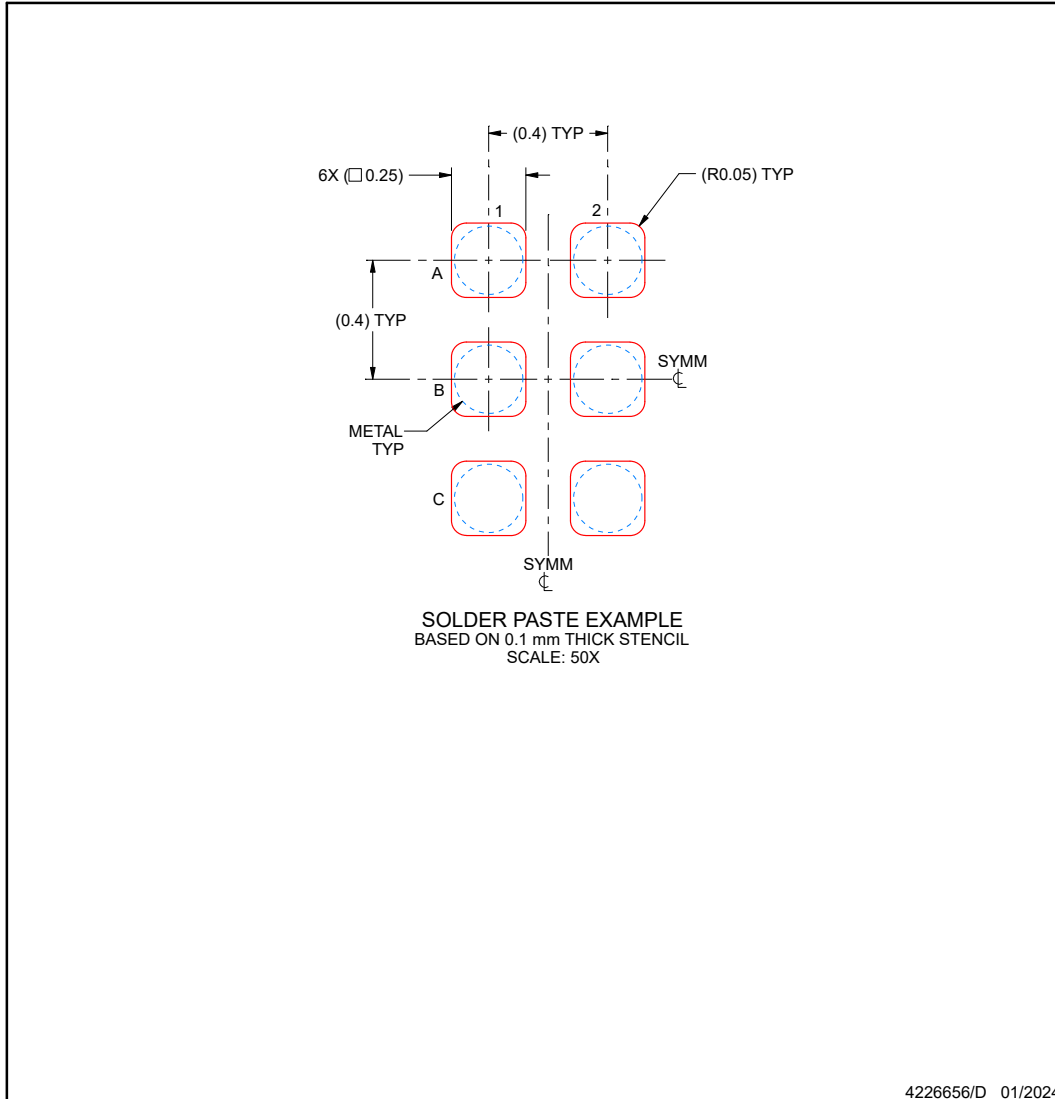

NOTES: (continued)

4. Laser cutting apertures with trapezoidal walls and rounded corners may offer better paste release.

## 重要なお知らせと免責事項

テキサス・インスツルメンツは、技術データと信頼性データ(データシートを含みます)、設計リソース(リファレンス デザインを含みます)、アプリケーションや設計に関する各種アドバイス、Web ツール、安全性情報、その他のリソースを、欠陥が存在する可能性のある「現状のまま」提供しており、商品性および特定目的に対する適合性の黙示保証、第三者の知的財産権の非侵害保証を含むいかなる保証も、明示的または黙示的にかかわらず拒否します。

これらのリソースは、テキサス・インスツルメンツ製品を使用する設計の経験を積んだ開発者への提供を意図したものです。(1) お客様のアプリケーションに適したテキサス・インスツルメンツ製品の選定、(2) お客様のアプリケーションの設計、検証、試験、(3) お客様のアプリケーションに該当する各種規格や、その他のあらゆる安全性、セキュリティ、規制、または他の要件への確実な適合に関する責任を、お客様のみが単独で負うものとします。

上記の各種リソースは、予告なく変更される可能性があります。これらのリソースは、リソースで説明されているテキサス・インスツルメンツ製品を使用するアプリケーションの開発の目的でのみ、テキサス・インスツルメンツはその使用をお客様に許諾します。これらのリソースに関して、他の目的で複製することや掲載することは禁止されています。テキサス・インスツルメンツや第三者の知的財産権のライセンスが付与されている訳ではありません。お客様は、これらのリソースを自身で使用した結果発生するあらゆる申し立て、損害、費用、損失、責任について、テキサス・インスツルメンツおよびその代理人を完全に補償するものとし、テキサス・インスツルメンツは一切の責任を拒否します。

テキサス・インスツルメンツの製品は、[テキサス・インスツルメンツの販売条件](#)、または [ti.com](https://www.ti.com) やかかるテキサス・インスツルメンツ製品の関連資料などのいずれかを通じて提供する適用可能な条項の下で提供されています。テキサス・インスツルメンツがこれらのリソースを提供することは、適用されるテキサス・インスツルメンツの保証または他の保証の放棄の拡大や変更を意味するものではありません。

お客様がいかなる追加条項または代替条項を提案した場合でも、テキサス・インスツルメンツはそれらに異議を唱え、拒否します。

郵送先住所: Texas Instruments, Post Office Box 655303, Dallas, Texas 75265  
Copyright © 2024, Texas Instruments Incorporated

**PACKAGING INFORMATION**

Orderable Device	Status (1)	Package Type	Package Drawing	Pins	Package Qty	Eco Plan (2)	Lead finish/ Ball material (6)	MSL Peak Temp (3)	Op Temp (°C)	Device Marking (4/5)	Samples
TMP119AIYBGR	ACTIVE	DSBGA	YBG	6	3000	RoHS & Green	SAC396	Level-1-260C-UNLIM	-55 to 150	OQ	Samples

(1) The marketing status values are defined as follows:

**ACTIVE:** Product device recommended for new designs.

**LIFEBUY:** TI has announced that the device will be discontinued, and a lifetime-buy period is in effect.

**NRND:** Not recommended for new designs. Device is in production to support existing customers, but TI does not recommend using this part in a new design.

**PREVIEW:** Device has been announced but is not in production. Samples may or may not be available.

**OBSELETE:** TI has discontinued the production of the device.

(2) **RoHS:** TI defines "RoHS" to mean semiconductor products that are compliant with the current EU RoHS requirements for all 10 RoHS substances, including the requirement that RoHS substance do not exceed 0.1% by weight in homogeneous materials. Where designed to be soldered at high temperatures, "RoHS" products are suitable for use in specified lead-free processes. TI may reference these types of products as "Pb-Free".

**RoHS Exempt:** TI defines "RoHS Exempt" to mean products that contain lead but are compliant with EU RoHS pursuant to a specific EU RoHS exemption.

**Green:** TI defines "Green" to mean the content of Chlorine (Cl) and Bromine (Br) based flame retardants meet JS709B low halogen requirements of <=1000ppm threshold. Antimony trioxide based flame retardants must also meet the <=1000ppm threshold requirement.

(3) MSL, Peak Temp. - The Moisture Sensitivity Level rating according to the JEDEC industry standard classifications, and peak solder temperature.

(4) There may be additional marking, which relates to the logo, the lot trace code information, or the environmental category on the device.

(5) Multiple Device Markings will be inside parentheses. Only one Device Marking contained in parentheses and separated by a "-" will appear on a device. If a line is indented then it is a continuation of the previous line and the two combined represent the entire Device Marking for that device.

(6) Lead finish/Ball material - Orderable Devices may have multiple material finish options. Finish options are separated by a vertical ruled line. Lead finish/Ball material values may wrap to two lines if the finish value exceeds the maximum column width.

**Important Information and Disclaimer:**The information provided on this page represents TI's knowledge and belief as of the date that it is provided. TI bases its knowledge and belief on information provided by third parties, and makes no representation or warranty as to the accuracy of such information. Efforts are underway to better integrate information from third parties. TI has taken and continues to take reasonable steps to provide representative and accurate information but may not have conducted destructive testing or chemical analysis on incoming materials and chemicals. TI and TI suppliers consider certain information to be proprietary, and thus CAS numbers and other limited information may not be available for release.

In no event shall TI's liability arising out of such information exceed the total purchase price of the TI part(s) at issue in this document sold by TI to Customer on an annual basis.

YBG0006

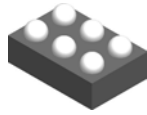

# PACKAGE OUTLINE

DSBGA - 0.5 mm max height

DIE SIZE BALL GRID ARRAY

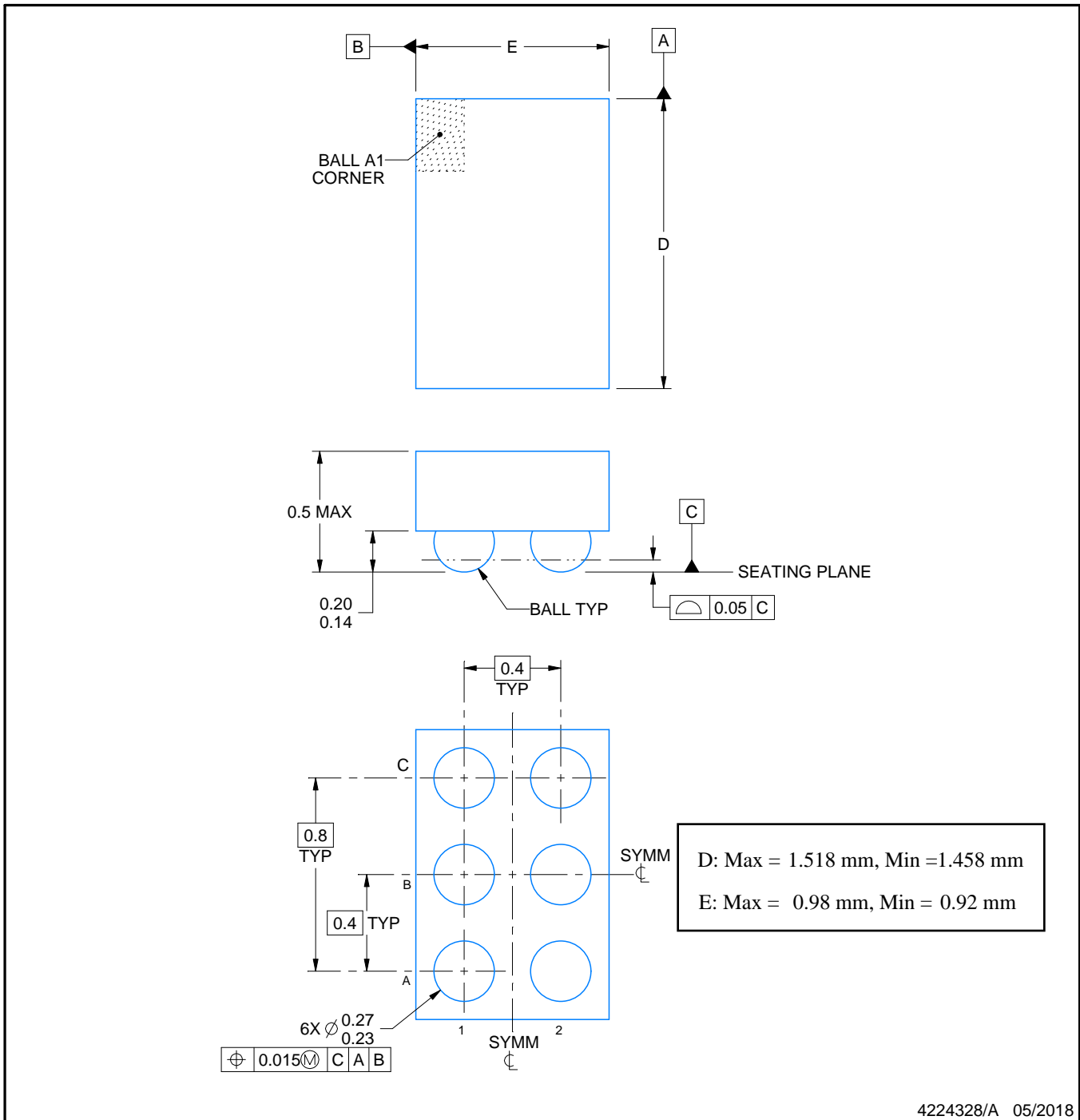

NOTES:

1. All linear dimensions are in millimeters. Any dimensions in parenthesis are for reference only. Dimensioning and tolerancing per ASME Y14.5M.
2. This drawing is subject to change without notice.



# EXAMPLE BOARD LAYOUT

YBG0006

DSBGA - 0.5 mm max height

DIE SIZE BALL GRID ARRAY

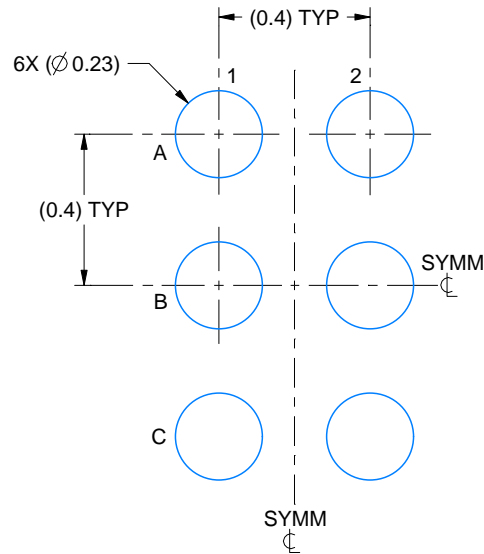

LAND PATTERN EXAMPLE  
EXPOSED METAL SHOWN  
SCALE: 50X

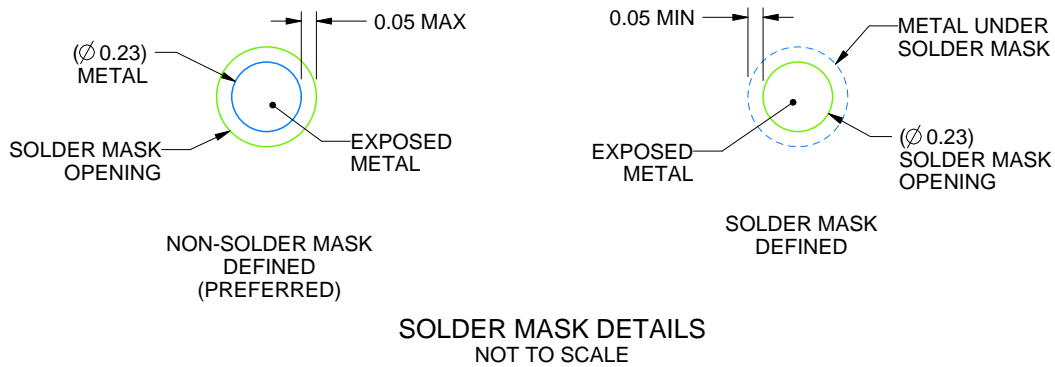

SOLDER MASK DETAILS  
NOT TO SCALE

4224328/A 05/2018

NOTES: (continued)

- Final dimensions may vary due to manufacturing tolerance considerations and also routing constraints. See Texas Instruments Literature No. SNVA009 ([www.ti.com/lit/snva009](http://www.ti.com/lit/snva009)).

# EXAMPLE STENCIL DESIGN

YBG0006

DSBGA - 0.5 mm max height

DIE SIZE BALL GRID ARRAY

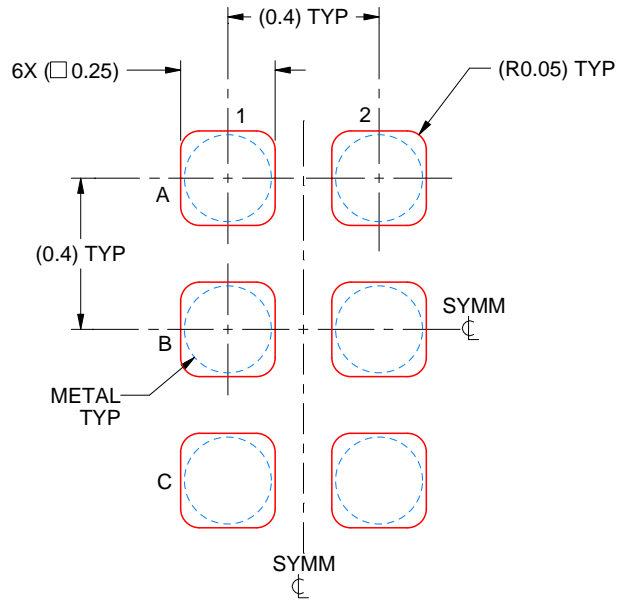

SOLDER PASTE EXAMPLE  
BASED ON 0.1 mm THICK STENCIL  
SCALE: 50X

4224328/A 05/2018

NOTES: (continued)

4. Laser cutting apertures with trapezoidal walls and rounded corners may offer better paste release.

## 重要なお知らせと免責事項

TI は、技術データと信頼性データ(データシートを含みます)、設計リソース(リファレンス・デザインを含みます)、アプリケーションや設計に関する各種アドバイス、Web ツール、安全性情報、その他のリソースを、欠陥が存在する可能性のある「現状のまま」提供しており、商品性および特定目的に対する適合性の黙示保証、第三者の知的財産権の非侵害保証を含むいかなる保証も、明示的または黙示的にかかわらず拒否します。

これらのリソースは、TI 製品を使用する設計の経験を積んだ開発者への提供を意図したものです。(1) お客様のアプリケーションに適した TI 製品の選定、(2) お客様のアプリケーションの設計、検証、試験、(3) お客様のアプリケーションに該当する各種規格や、その他のあらゆる安全性、セキュリティ、規制、または他の要件への確実な適合に関する責任を、お客様のみが単独で負うものとし、

上記の各種リソースは、予告なく変更される可能性があります。これらのリソースは、リソースで説明されている TI 製品を使用するアプリケーションの開発の目的でのみ、TI はその使用をお客様に許諾します。これらのリソースに関して、他の目的で複製することや掲載することは禁止されています。TI や第三者の知的財産権のライセンスが付与されている訳ではありません。お客様は、これらのリソースを自身で使用した結果発生するあらゆる申し立て、損害、費用、損失、責任について、TI およびその代理人を完全に補償するものとし、TI は一切の責任を拒否します。

TI の製品は、[TI の販売条件](#)、または [ti.com](#) やかかる TI 製品の関連資料などのいずれかを通じて提供する適用可能な条項の下で提供されています。TI がこれらのリソースを提供することは、適用される TI の保証または他の保証の放棄の拡大や変更を意味するものではありません。

お客様がいかなる追加条項または代替条項を提案した場合でも、TI はそれらに異議を唱え、拒否します。

郵送先住所 : Texas Instruments, Post Office Box 655303, Dallas, Texas 75265  
Copyright © 2024, Texas Instruments Incorporated