

TMAG5123 同一面内、高精度、高電圧、ホール・エフェクト・スイッチ

1 特長

- 同一面内、オムニポーラ・ホール・エフェクト・スイッチ
- 高い磁気感度:
 - TMAG5123B: $\pm 4.1\text{mT}$ (標準値)
 - TMAG5123C: $\pm 7.5\text{mT}$ (標準値)
 - TMAG5123D: $\pm 10.9\text{mT}$ (標準値)
- 広い電圧範囲に対応
 - 2.5V~38V の V_{CC} 範囲で動作
 - 外部レギュレータ不要
- 広い動作温度範囲
 - 動作時周囲温度範囲: $-40^{\circ}\text{C} \sim +125^{\circ}\text{C}$
- 30kHz の連続変換
- オープン・ドレイン出力
- SOT-23 パッケージ・オプション
- 保護機能
 - 最大 40V の負荷ダンプをサポート
 - 20V までのバッテリー逆極性保護
 - 出力短絡保護
 - 出力電流制限

2 アプリケーション

- 大型家電製品
- 小型家電製品
- コードレス掃除ロボット
- 流量計
- 住宅用ブレーカ
- 開放および短絡の検出

3 概要

TMAG5123 はチョップ安定化されたオムニポーラ、アクティブ LOW、同一平面内、ホール・エフェクト・スイッチ・センサです。TMAG5123 は表面実装の SOT-23 パッケージであり、プリント基板 (PCB) の表面に平行な磁界を測定するので、センサの機械的配置が容易になります。

アプリケーション固有の要件に合わせて、異なる感度レベルの製品が提供されています。印加された磁束密度の値が磁界の絶対値で動作点 (BOP) スレッシュホールドを上回ると、オープン・ドレイン出力は LOW 状態の電圧になります。この出力は、印加された磁界の絶対値が復帰点 (BRP) スレッシュホールドよりも低くなるまで LOW のままです。

TMAG5123 は、2.5V~38V の広い動作電圧範囲と、最大 -20V の逆極性保護を内蔵しているため、産業用アプリケーションに適した堅牢な動作を実現できます。

製品情報

| 部品番号 | パッケージ ⁽¹⁾ | 本体サイズ (公称) |
|----------|----------------------|-----------------|
| TMAG5123 | SOT-23 (3) | 2.92mm × 1.30mm |

- (1) 利用可能なすべてのパッケージについては、このデータシートの末尾にあるパッケージ・オプションについての付録を参照してください。

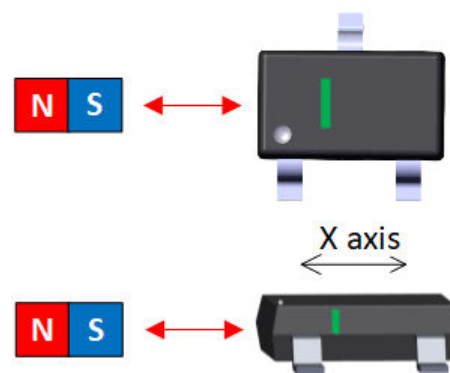

同一平面内センサ



Table of Contents

| | | | |
|--|----------|--|-----------|
| 1 特長 | 1 | 8.3 Feature Description..... | 9 |
| 2 アプリケーション | 1 | 8.4 Device Functional Modes..... | 14 |
| 3 概要 | 1 | 9 Application and Implementation | 15 |
| 4 Revision History | 2 | 9.1 Application Information..... | 15 |
| 5 Device Comparison Table | 3 | 9.2 Typical Applications..... | 15 |
| 6 Pin Configuration and Functions | 3 | 10 Power Supply Recommendations | 19 |
| 7 Specifications | 4 | 11 Layout | 19 |
| 7.1 Absolute Maximum Ratings | 4 | 11.1 Layout Guidelines..... | 19 |
| 7.2 ESD Ratings | 4 | 11.2 Layout Example..... | 19 |
| 7.3 Recommended Operating Conditions | 4 | 12 Device and Documentation Support | 20 |
| 7.4 Thermal Information | 4 | 12.1 Receiving Notification of Documentation Updates.. | 20 |
| 7.5 Electrical Characteristics | 5 | 12.2 サポート・リソース..... | 20 |
| 7.6 Magnetic Characteristics | 5 | 12.3 Trademarks..... | 20 |
| 7.7 Typical Characteristics..... | 6 | 12.4 Electrostatic Discharge Caution..... | 20 |
| 8 Detailed Description | 9 | 12.5 Glossary..... | 20 |
| 8.1 Overview..... | 9 | 13 Mechanical, Packaging, and Orderable Information | 20 |
| 8.2 Functional Block Diagram..... | 9 | | |

4 Revision History

| DATE | REVISION | NOTES |
|----------|----------|-----------------|
| May 2021 | * | Initial Release |

5 Device Comparison Table

| DEVICE | DEVICE OPTION | Threshold level (BOP) |
|----------|---------------|-----------------------|
| TMAG5123 | B | 4.1mT |
| | C | 7.5mT |
| | D | 10.9mT |

6 Pin Configuration and Functions



图 6-1. DBZ Package 3-Pin SOT-23 Top View

表 6-1. Pin Functions

| PIN | | TYPE | DESCRIPTION |
|-----|------|--------------|---|
| NO. | NAME | | |
| 1 | VCC | Power supply | 2.5-V to 38-V power supply. Connect a ceramic capacitor with a value of at least 0.01 μ F (minimum) between VCC and ground. |
| 2 | OUT | Output | Hall sensor open-drain output. The open drain requires a pull-up resistor |
| 3 | GND | Ground | Ground reference. |

7 Specifications

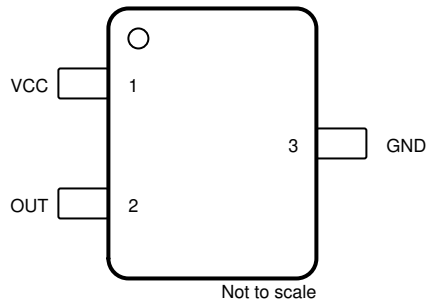
7.1 Absolute Maximum Ratings

over operating free-air temperature range (unless otherwise noted)⁽¹⁾

| | | MIN | MAX | UNIT |
|---|----------|-----------|-----|-----------|
| Power Supply Voltage | V_{CC} | -20 | 40 | V |
| Magnetic Flux Density, B _{MAX} | | Unlimited | | T |
| Junction temperature, T_J | | | | 150 °C |
| Storage temperature, T_{stg} | | -65 | 150 | °C |

- (1) Stresses beyond those listed under *Absolute Maximum Rating* may cause permanent damage to the device. These are stress ratings only, which do not imply functional operation of the device at these or any other conditions beyond those indicated under *Recommended Operating Condition*. Exposure to absolute-maximum-rated conditions for extended periods may affect device reliability.

7.2 ESD Ratings

| | | | VALUE | UNIT |
|-------------|-------------------------|--|-------|------|
| $V_{(ESD)}$ | Electrostatic discharge | Human body model (HBM), per ANSI/ESDA/ JEDEC JS-001, all pins ⁽¹⁾ | ±2000 | V |
| | | Charged device model (CDM), per JEDEC specification JESD22-C101, all pins ⁽²⁾ | ± 500 | |

- (1) JEDEC document JEP155 states that 500-V HBM allows safe manufacturing with a standard ESD control process.
 (2) JEDEC document JEP157 states that 250-V CDM allows safe manufacturing with a standard ESD control process.

7.3 Recommended Operating Conditions

over operating free-air temperature range (unless otherwise noted)

| | | MIN | MAX | UNIT |
|------------|-------------------------|-----|-----|------|
| V_{CC} | Power supply voltage | 2.5 | 38 | V |
| V_O | Output pin voltage | 0 | 38 | V |
| I_{SINK} | Output pin current sink | 0 | 20 | mA |
| T_A | Ambient temperature | -40 | 125 | °C |

7.4 Thermal Information

| THERMAL METRIC ⁽¹⁾ | | TMAG5123 | UNIT |
|-------------------------------|--|--------------|------|
| | | DBZ (SOT-23) | |
| | | 3 PINS | |
| $R_{\theta JA}$ | Junction-to-ambient thermal resistance | 197.7 | °C/W |
| $R_{\theta JC(top)}$ | Junction-to-case (top) thermal resistance | 87.1 | °C/W |
| $R_{\theta JB}$ | Junction-to-board thermal resistance | 27.4 | °C/W |
| Ψ_{JT} | Junction-to-top characterization parameter | 3.7 | °C/W |
| Ψ_{JB} | Junction-to-board characterization parameter | 27.1 | °C/W |

- (1) For more information about traditional and new thermal metrics, see the [Semiconductor and IC Package Thermal Metrics](#) application report.

7.5 Electrical Characteristics

over operating free-air temperature range (unless otherwise noted)

| PARAMETER | | TEST CONDITIONS | MIN | TYP | MAX | UNIT |
|---------------------------|------------------------------|--|------|------|-----|---------|
| POWER SUPPLY | | | | | | |
| I_{CC} | Operating supply current | $V_{CC} = 2.5V \text{ to } 38V, T_A = 25^\circ C$ | | 3.5 | | mA |
| I_{CC} | Operating supply current | $V_{CC} = 2.5V \text{ to } 38V, T_A = -40^\circ C \text{ to } 125^\circ C$ | | 3.5 | 5.4 | mA |
| I_{RCC} | Reverse-battery current | $V_{CC} = -20V$ | -100 | | | μA |
| t_{ON} | Power-on-time | | | 62.5 | | μs |
| P_{OS} | Power-on-state | $V_{CC} > V_{CCmin}, t > t_{ON}$ | | High | | |
| OUTPUT | | | | | | |
| V_{OL} | Low-level output voltage | $I_{OL} = 5mA$ | 0 | | 0.5 | V |
| I_{OH} | Output leakage current | $V_{CC} = 5V$ | | 0.1 | 1 | μA |
| I_{SC} | Output short-circuit current | | | 65 | 100 | mA |
| t_R | Output rise time | $R_L = 1k\Omega, C_L = 50pF, V_{CC} = 12V$ | | 0.2 | | μs |
| t_F | Output fall time | $R_L = 1k\Omega, C_L = 50pF, V_{CC} = 12V$ | | 0.2 | | μs |
| t_{PD} | Propagation delay time | Change in B field to change in output | | 50 | | μs |
| FREQUENCY RESPONSE | | | | | | |
| f_{CHOP} | Chopping frequency | | | 320 | | kHz |
| f_{BW} | Signal bandwidth | | | 10 | | kHz |

7.6 Magnetic Characteristics

over operating free-air temperature range (unless otherwise noted)

| PARAMETER | | TEST CONDITIONS | MIN | TYP | MAX | UNIT |
|------------------|---------------------------------------|--|-----------|------------|-----------|------|
| TMAG5123B | | | | | | |
| B_{OP} | Magnetic field operating point | $V_{CC} = 2.5V \text{ to } 38V, T_A = -40^\circ C \text{ to } 125^\circ C$ | ± 2.2 | ± 4.1 | ± 6 | mT |
| B_{RP} | Magnetic field release point | | ± 0.3 | ± 2.2 | ± 4 | mT |
| B_{HYS} | Magnetic hysteresis $B_{OP} - B_{RP}$ | | ± 0.5 | ± 1.9 | ± 3 | mT |
| TMAG5123C | | | | | | |
| B_{OP} | Magnetic field operating point | $V_{CC} = 2.5V \text{ to } 38V, T_A = -40^\circ C \text{ to } 125^\circ C$ | ± 5.5 | ± 7.5 | ± 9.5 | mT |
| B_{RP} | Magnetic field release point | | ± 3.5 | ± 5.5 | ± 7.5 | mT |
| B_{HYS} | Magnetic hysteresis $B_{OP} - B_{RP}$ | | ± 0.5 | ± 2 | ± 3 | mT |
| TMAG5123D | | | | | | |
| B_{OP} | Magnetic field operating point | $V_{CC} = 2.5V \text{ to } 38V, T_A = -40^\circ C \text{ to } 125^\circ C$ | ± 8.7 | ± 10.9 | ± 13 | mT |
| B_{RP} | Magnetic field release point | | ± 6.7 | ± 8.9 | ± 11 | mT |
| B_{HYS} | Magnetic hysteresis $B_{OP} - B_{RP}$ | | ± 0.5 | ± 2 | ± 3 | mT |

7.7 Typical Characteristics

at $T_A = 25^\circ\text{C}$ typical and $V_{CC} = 6\text{V}$ (unless otherwise noted)

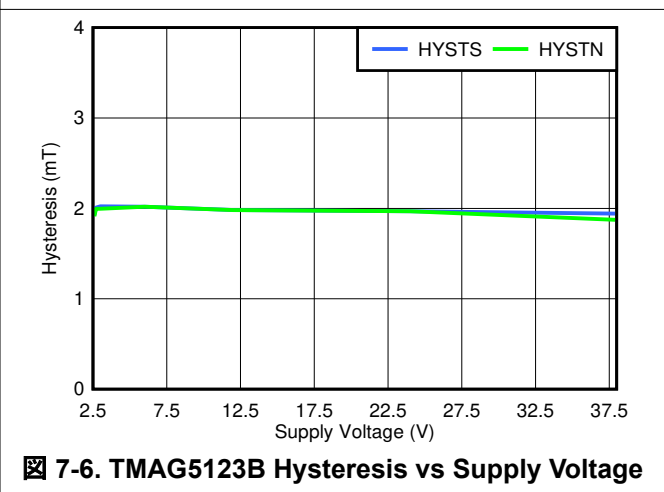
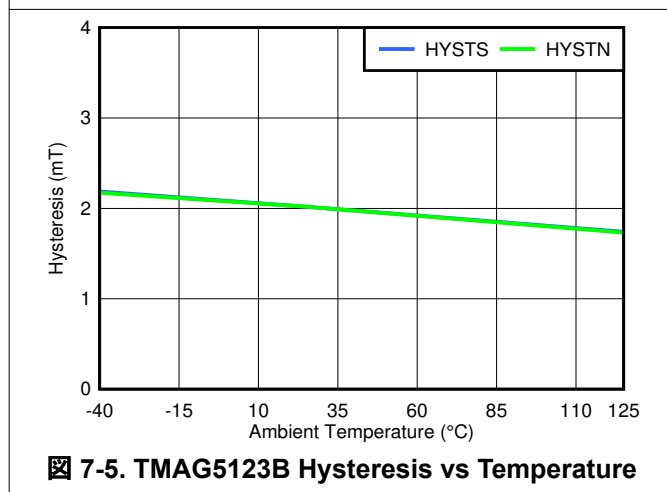
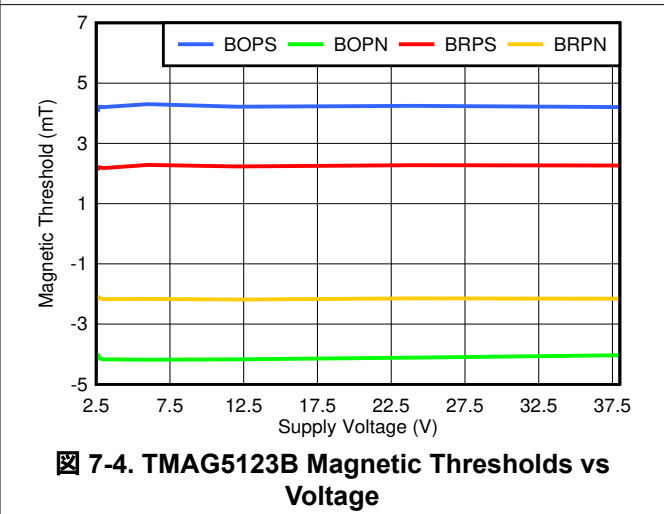
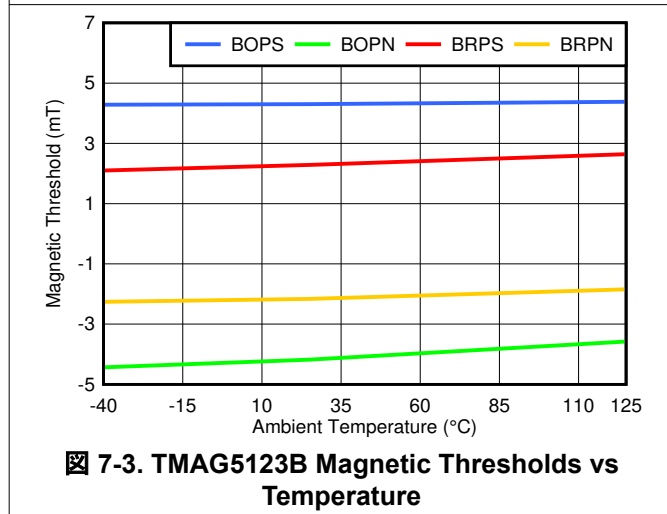
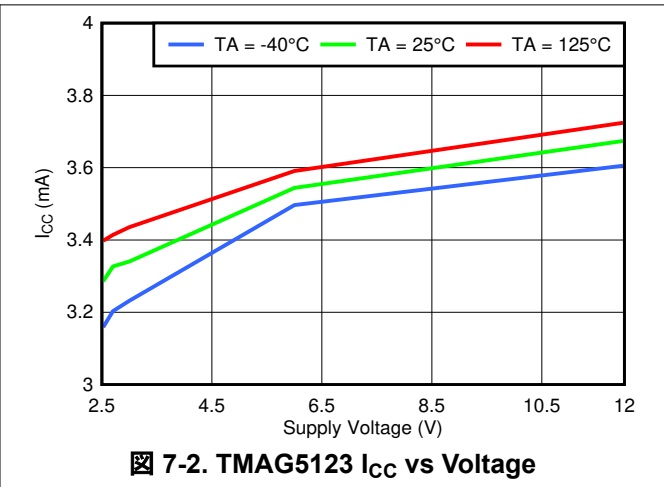
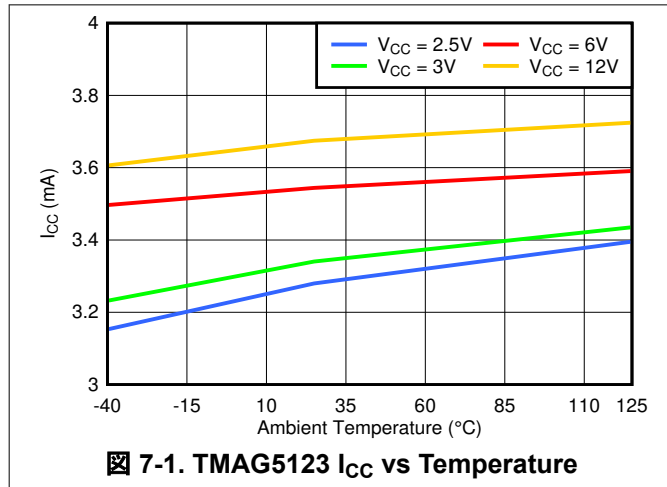

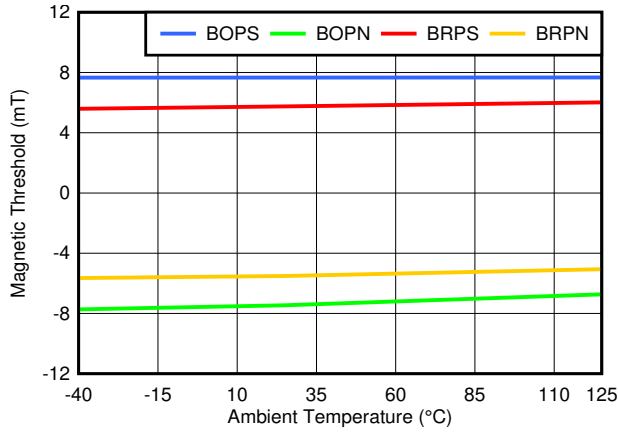

7-7. TMAG5123C Magnetic Thresholds vs Temperature

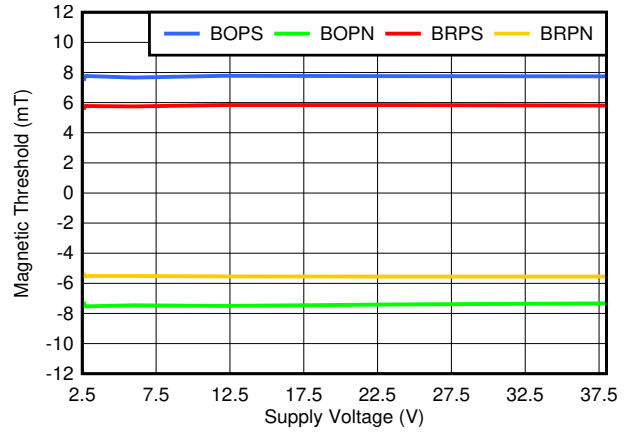

7-8. TMAG5123C Magnetic Thresholds vs Voltage

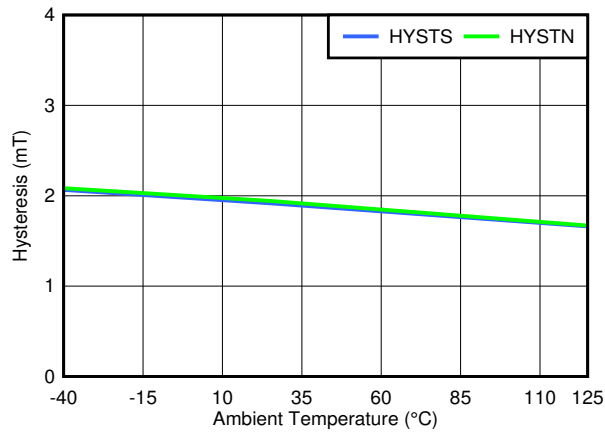

7-9. TMAG5123C Hysteresis vs Temperature

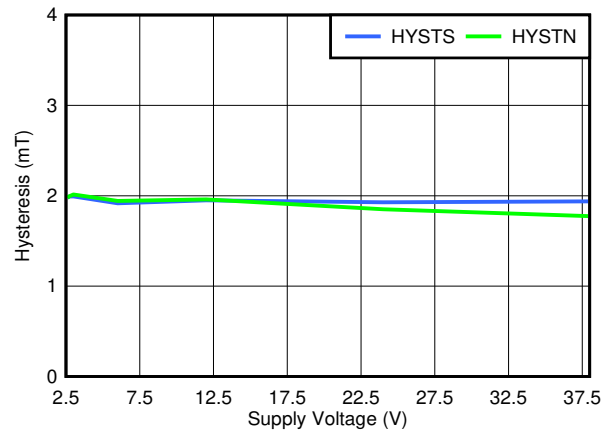

7-10. TMAG5123C Hysteresis vs Supply Voltage

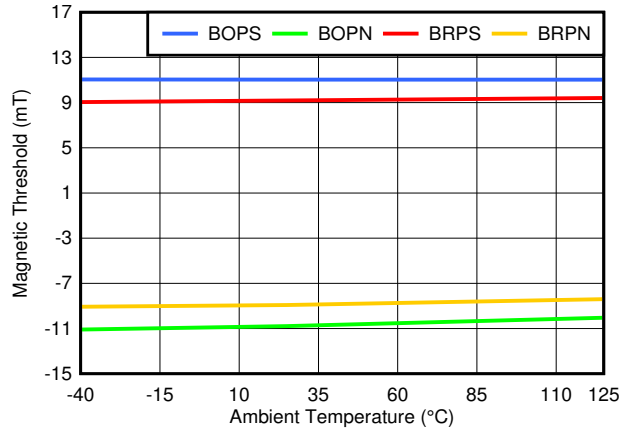

7-11. TMAG5123D Magnetic Thresholds vs Temperature

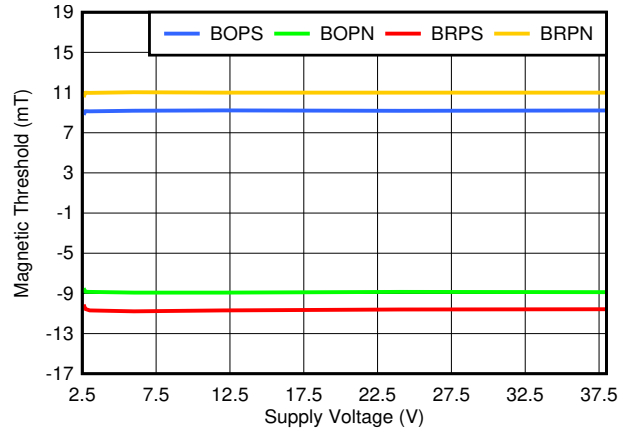

7-12. TMAG5123D Magnetic Thresholds vs Voltage

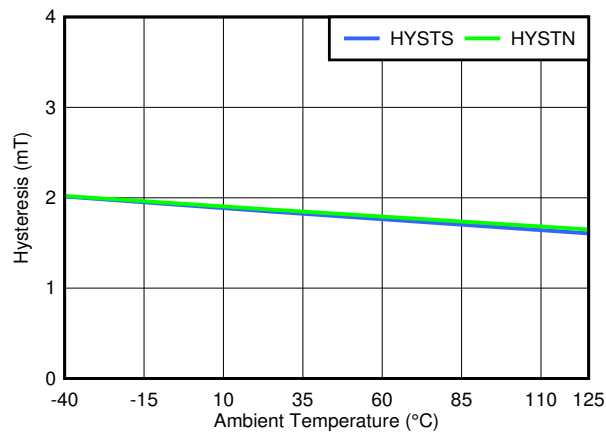

7-13. TMAG5123D Hysteresis vs Temperature

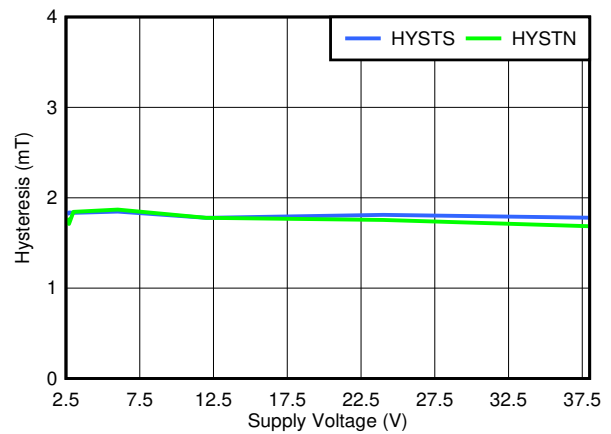

7-14. TMAG5123D Hysteresis vs Supply Voltage

8 Detailed Description

8.1 Overview

The TMAG5123 device is a chopper-stabilized Hall sensor with a digital omnipolar switch output for magnetic sensing applications. The TMAG5123 device can be powered with a supply voltage range between 2.5-V and 38 V, and can withstand -20 -V reverse battery conditions continuously. Note that the TMAG5123 device will not operate when approximately -20 -V to 2.5-V is applied to the VCC pin (with respect to GND). In addition, the device can withstand voltages up to 40 V for transient durations.

While most of the Hall-effect sensors switch their output in the presence of a vertical field, the TMAG5123 will switch the output in the presence of a horizontal field. The TMAG5123 is then an in-plane or vertical sensor, sensitive to a horizontal or parallel magnetic fields.

The omnipolar configuration allows the Hall sensor to respond to either a south or north pole. A strong magnetic field of either polarity will cause the output to pull low (operate point, BOP), and a weaker magnetic field will cause the output to release (release point, BRP). Hysteresis is included in between the operate and release points, so magnetic field noise will not trip the output accidentally.

An external pullup resistor is required on the OUT pin. The OUT pin can be pulled up to VCC, or to a different voltage supply. This allows for easier interfacing with controller circuits.

8.2 Functional Block Diagram

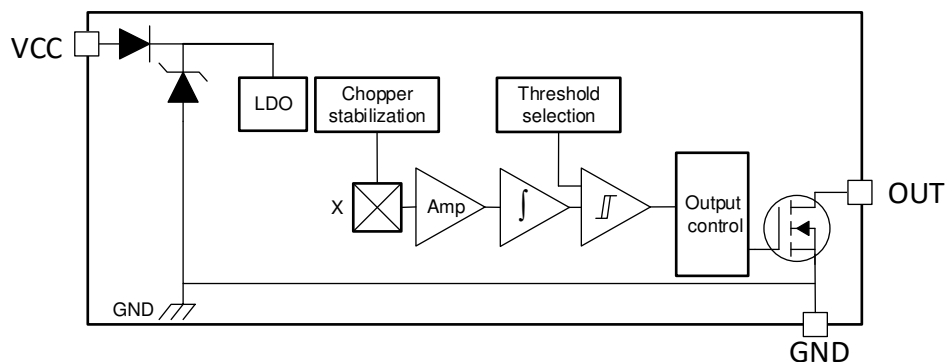

8-1. Block Diagram

8.3 Feature Description

8.3.1 Field Direction Definition

The TMAG5123 is sensitive to both south and north poles in the same plane as the die as shown 8-2.

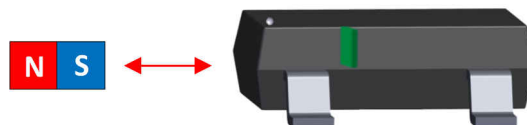

8-2. Field Direction Definition

8.3.2 Device Output

The TMAG5123 is featured with an open drain output. In order to generate a two state output, a pull-up resistor needs to be added.

Once the device is powered and with no magnetic field applied to it, the output stays at $V_{out}(H)$. As an omnipolar sensor the output will go down to $V_{out}(L)$ when the field increase beyond the BOP threshold either with a north or a south magnetic field. When the field decrease below the BRP threshold, either with a north or a south magnetic field, the output will go up to $V_{out}(H)$



图 8-3. Omnipolar Functionality

8.3.3 Protection Circuits

The TMAG5123 device is protected against load dump and reverse-supply conditions

8.3.3.1 Load Dump Protection

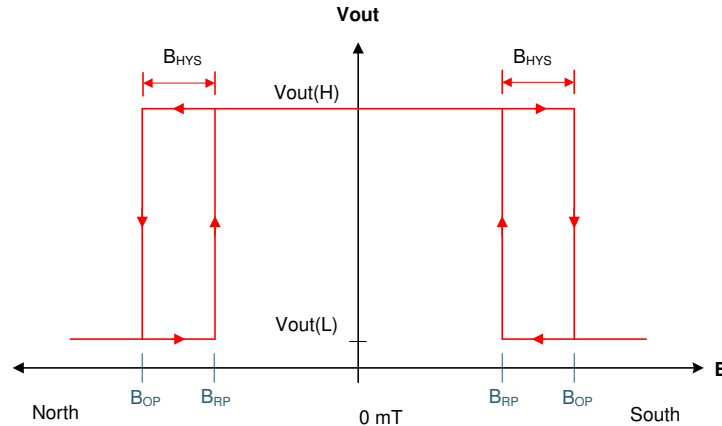
The TMAG5123 device operates at DC VCC conditions up to 38-V nominally, and can additionally withstand VCC = 40-V. No current-limiting series resistor is required for this protection.

8.3.3.2 Reverse Supply Protection

The TMAG5123 device is protected in the event that the VCC pin and the GND pin are reversed (up to -20-V).

8.3.4 Hall Element Location

The sensing element inside the device is in the center of both packages when viewed from the top. [Figure 8-4](#) shows the tolerances and side-view dimensions.

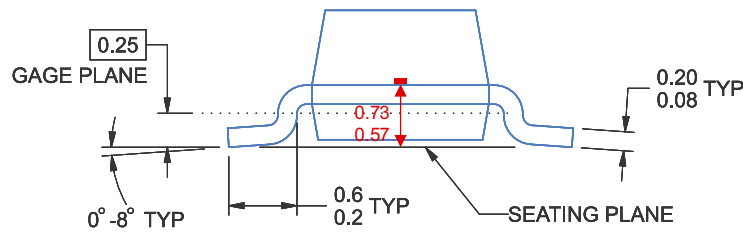
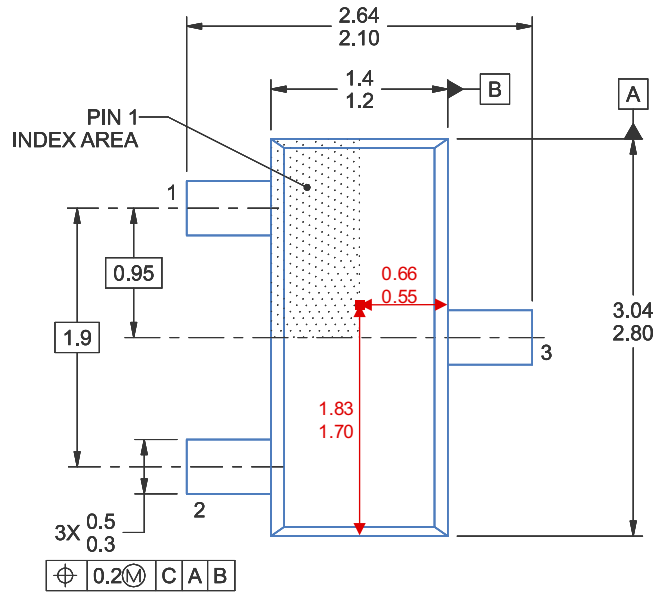

Figure 8-4. Hall Element Location

8.3.5 Power-On Time

☒ 8-5 shows the behavior of the device after the V_{CC} voltage is applied and when the field is below the B_{OP} threshold. Once the minimum value for V_{CC} is reached, the TMAG5123 will take time t_{ON} to power up and then time t_{PD} to update the output to a level High.

☒ 8-6 shows the behavior of the device after the V_{CC} voltage is applied and when the field is above the B_{OP} threshold. Once the minimum value for V_{CC} is reached, the TMAG5123 will take time t_{ON} to power up and then time t_{PD} to update the output to a level Low.

The output value during t_{ON} is unknown in both cases. The output value at the end of t_{ON} will be set at High.

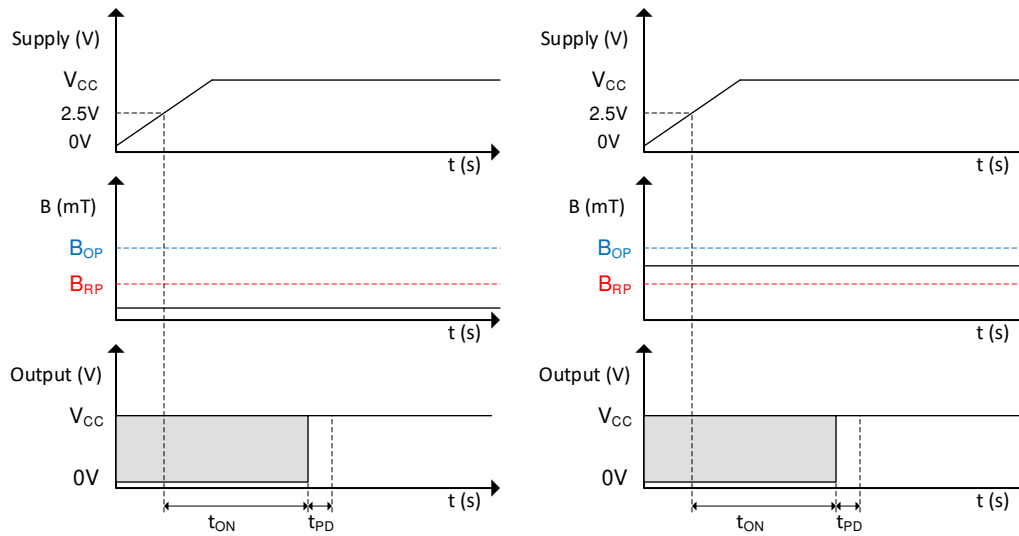

☒ 8-5. Power-On Time When $B < B_{OP}$

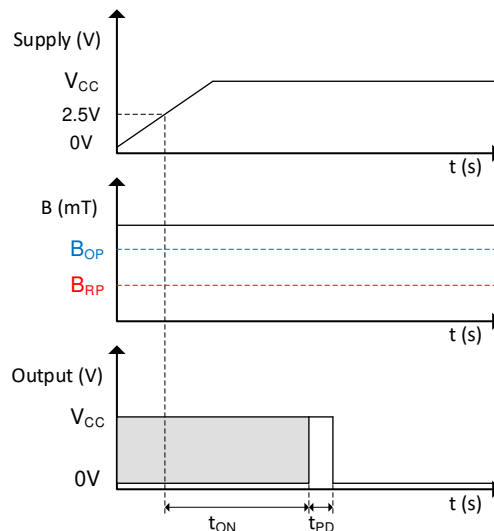

☒ 8-6. Power-On Time When $B > B_{OP}$

8.3.6 Propagation Delay

The TMAG5123 samples the Hall element at a nominal sampling interval of t_{PD} to detect the presence of a magnetic south or north pole. Between each sampling interval, the device calculates the average magnetic field applied to the device. If this average value crosses the B_{OP} or B_{RP} threshold, the device changes the corresponding level as defined in ☒ 8-3. The Hall sensor + magnet system is by nature asynchronous, therefore

the propagation delay (t_{PD}) will vary depending on when the magnetic field goes above the B_{OP} value. As shown in [Figure 8-7](#), the output delay also depends on when the magnetic field goes above the B_{OP} value.

The first graph in [Figure 8-7](#) shows the typical case. The magnetic field goes above the B_{OP} value at the moment the output is updated. The part will only require one sampling period of t_{PD} to update the output.

The second graph in [Figure 8-7](#) shows a magnetic field going above the B_{OP} value just before half of the sampling period. This is the best-case scenario where the output is updated in just half of the sampling period.

Finally, the third graph in [Figure 8-7](#) shows the worst-case scenario where the magnetic field goes above the B_{OP} value just after half of the sampling period. At the next output update, the device will still see the magnetic field under the B_{OP} threshold and will require a whole new sampling period to update the output.

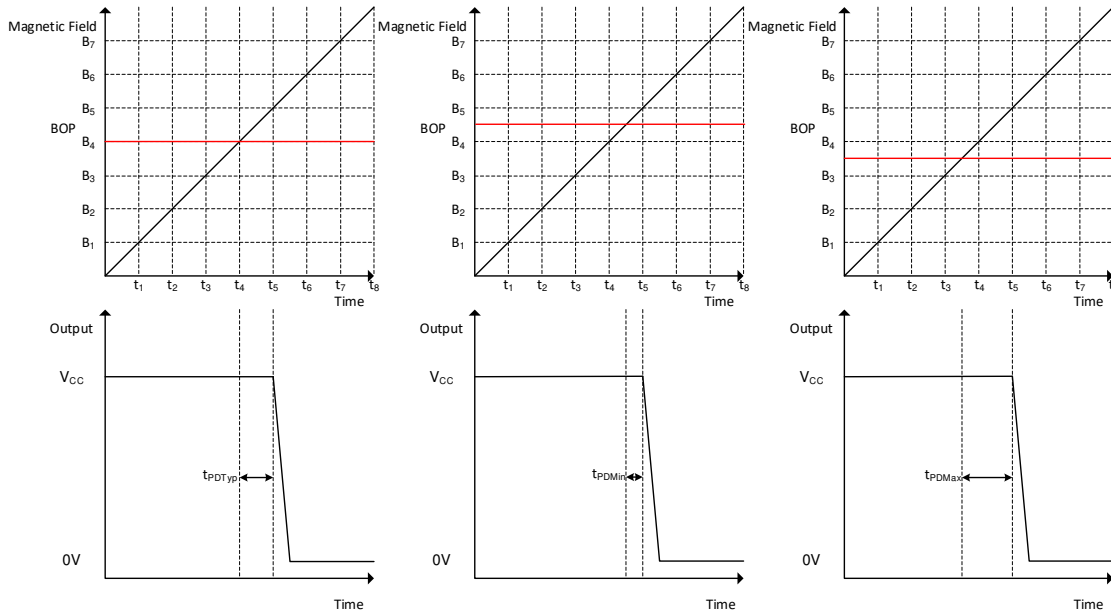
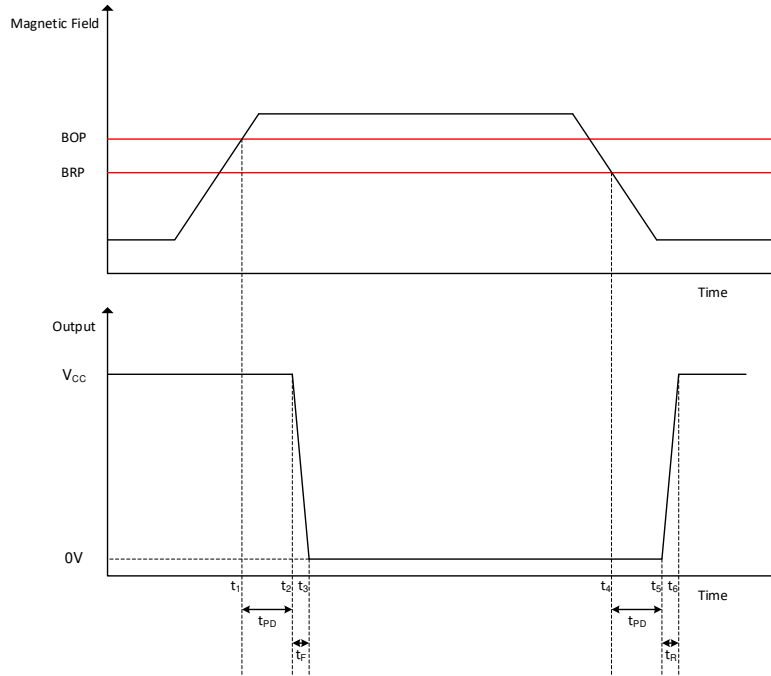

Figure 8-7. Field Sampling Timing

[Figure 8-8](#) shows TMAG5123 propagation delay analysis when a magnetic south or north pole is applied. The Hall element of the TMAG5123 experiences an increasing magnetic field as a magnetic south or north pole approaches the device, as well as a decreasing magnetic field as a magnetic south or north pole moves away. At time t_1 , the magnetic field goes above the B_{OP} threshold. The output will then start to move after the propagation delay (t_{PD}). This time will vary depending on when the sampling period is, as shown in [Figure 8-7](#). At t_2 , the output start pulling the output voltage Low. At t_3 , the output is completely pulled down. The same process happens on the other way when the magnetic value is going under the B_{RP} threshold.



8-8. Propagation Delay

8.3.7 Chopper Stabilization

The Basic Hall-effect sensor consists of four terminals where a current is injected through two opposite terminals and a voltage is measured through the other opposite terminals. The voltage measured is proportional to the current injected and the magnetic field measured. By knowing the current injected, the device can then know the magnetic field strength. The problem is that the voltage generated is small in amplitude while the offset voltage generated is more significant. To create a precise sensor, the offset voltage must be minimized.

Chopper stabilization is one way to significantly minimize this offset. It is achieved by "spinning" the sensor and sequentially applying the bias current and measuring the voltage for each pair of terminals. This means that a measurement is completed once the spinning cycle is completed. The full cycle is completed after sixteen measurements. The output of the sensor is connected to an amplifier and an integrator that will accumulate and filter out a voltage proportional to the magnetic field present. Finally, a comparator will switch the output if the voltage reaches either the BOP or BRP threshold (depending on which state the output voltage was previously in).

The frequency of each individual measurement is referred to as the Chopping frequency, or f_{CHOP} . The total conversion time is referred to as the Propagation delay time, t_{PD} , and is basically equal to $16/f_{CHOP}$. Finally, the Signal bandwidth, f_{BW} , represents the maximum value of the magnetic field frequency, and is equal to $(f_{CHOP}/16)/2$ as defined by the sampling theorem.

8.4 Device Functional Modes

The device operates in only one mode when operated within the *Recommended Operating Conditions*.

9 Application and Implementation

Note

以下のアプリケーション情報は、TI の製品仕様に含まれるものではなく、TI ではその正確性または完全性を保証いたしません。個々の目的に対する製品の適合性については、お客様の責任で判断していただくこととなります。お客様は自身の設計実装を検証しテストすることで、システムの機能を確認する必要があります。

9.1 Application Information

The TMAG5123 is typically used in magnetic-field sensing applications to detect the proximity of a magnet that is in the "in-plane" axis from the sensor. The magnet is often attached to a movable component in the system.

The TMAG5123 is a Hall sensor that implements a Hall sensing element that senses parallel to the package of the part rather than through the z-axis of the device. This eases constraints in system design where a parallel magnetic field is needed to be detected, but normal industry packages, such as TO-92 are undesirable due to space constraints.

9.2 Typical Applications

9.2.1 In-Plane Typical Application Diagrams



図 9-1. Typical In-Plane Sensing Diagram

9.2.1.1 Design Requirements

For this design example, use the parameters listed in one of the 3 tables below depending on which version of the device is used.

表 9-1. Design Parameters for TMAG5123B

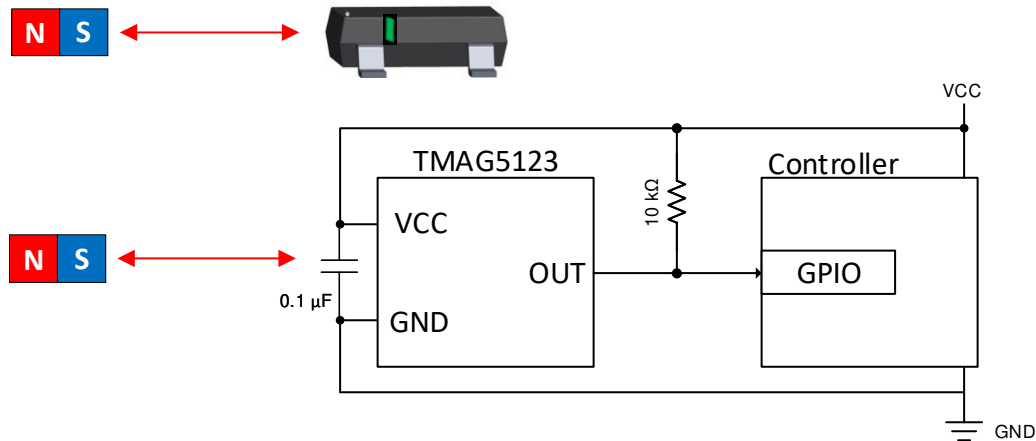
| DESIGN PARAMETER | EXAMPLE VALUE |
|------------------------------------|-------------------------------------|
| Vcc | 12V |
| TMAG5123 Device | TMAG5123B |
| Magnet | 1-cm Cube NdFeB (N45) |
| Minimum Magnet Distance to Operate | 2.8 cm (± 6 mT) with BOP Max |
| Maximum Magnet Distance to Release | 8.4 cm (± 0.3 mT) with BRP Min |

表 9-2. Design Parameters for TMAG5123C

| DESIGN PARAMETER | EXAMPLE VALUE |
|------------------------------------|--------------------------------------|
| Vcc | 12V |
| TMAG5123 Device | TMAG5123C |
| Magnet | 1-cm Cube NdFeB (N45) |
| Minimum Magnet Distance to Operate | 2.33 cm (± 9.5 mT) with BOP Max |
| Maximum Magnet Distance to Release | 3.44 cm (± 3.5 mT) with BRP Min |

表 9-3. Design Parameters for TMAG5123D

| DESIGN PARAMETER | EXAMPLE VALUE |
|------------------------------------|--------------------------------------|
| Vcc | 12V |
| TMAG5123 Device | TMAG5123D |
| Magnet | 1-cm Cube NdFeB (N45) |
| Minimum Magnet Distance to Operate | 2.04 cm (± 13 mT) with BOP Max |
| Maximum Magnet Distance to Release | 2.68 cm (± 6.7 mT) with BRP Min |

9.2.1.2 Detailed Design Procedure

When designing a digital-switch magnetic sensing system, three variables should always be considered: the magnet, sensing distance, and threshold of the sensor.

The TMAG5123 device has a detection threshold specified by parameter B_{OP} , which is the amount of magnetic flux required to pass through the Hall sensor mounted inside the TMAG5123. To reliably activate the sensor, the magnet must apply a flux greater than the maximum specified B_{OP} . In such a system, the sensor typically detects the magnet before it has moved to the closest position, but designing to the maximum parameter ensures robust turn-on for all possible values of B_{OP} . When the magnet moves away from the sensor, it must apply less than the minimum specified B_{RP} to reliably release the sensor.

Magnets are made from various ferromagnetic materials that have tradeoffs in cost, drift with temperature, absolute maximum temperature ratings, remanence or residual induction (B_r), and coercivity (H_c). The B_r and the dimensions of a magnet determine the magnetic flux density (B) it produces in 3-dimensional space. For simple magnet shapes, such as rectangular blocks and cylinders, there are simple equations that solve B at a given distance centered with the magnet.



图 9-2. Rectangular Block and Cylinder Magnets

Use 式 1 for the rectangular block shown in 图 9-2:

$$\vec{B} = \frac{B_r}{\pi} \left(\arctan \left(\frac{WL}{2D\sqrt{4D^2 + W^2 + L^2}} \right) - \arctan \left(\frac{WL}{2(D+T)\sqrt{4(D+T)^2 + W^2 + L^2}} \right) \right) \quad (1)$$

Use 式 2 for the cylinder shown in 图 9-2:

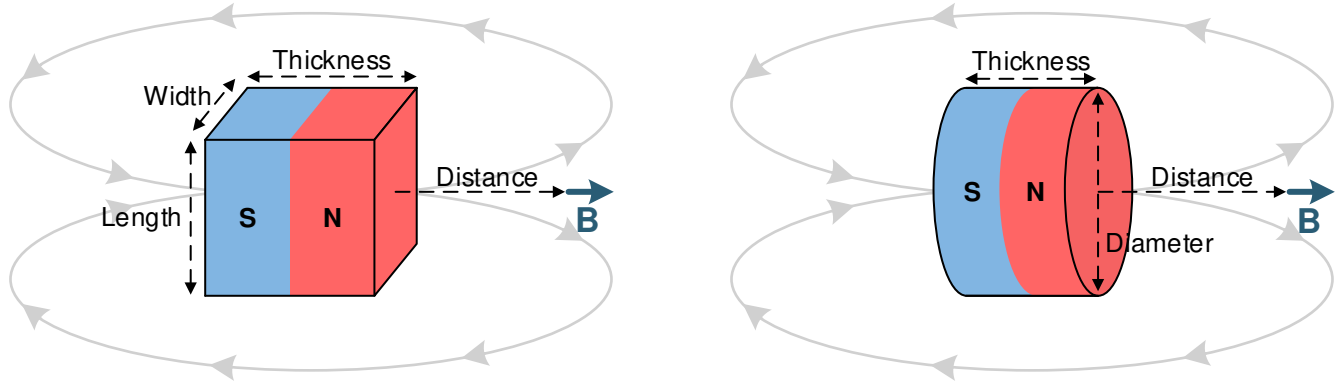
$$\vec{B} = \frac{B_r}{2} \left(\frac{D+T}{\sqrt{(0.5C)^2 + (D+T)^2}} - \frac{D}{\sqrt{(0.5C)^2 + D^2}} \right) \quad (2)$$

where

- W is width.
- L is length.
- T is thickness (the direction of magnetization).
- D is distance.
- C is diameter.

An online tool, the *Hall Effect Switch Magnetic Field Calculator*, that uses these formulas is located at <http://www.ti.com/product/tmag5123>.

All magnetic materials generally have a lower B_r at higher temperatures. Systems should have margin to account for this, as well as for mechanical tolerances.

For the TMAG5123B, the maximum BOP is 4.5 mT. Choosing a 1-cm cube NdFeB N45 magnet, Equation 1 shows that this point occurs at 3.05 cm. This means that, provided the design places the magnet within 3.05 cm from the sensor during a "turn-on" event, the magnet will activate the sensor. The removal of the magnet away from the device will ensure a crossing of the minimum BRP point and will return the device to its initial state.

9.2.1.3 Application Curve

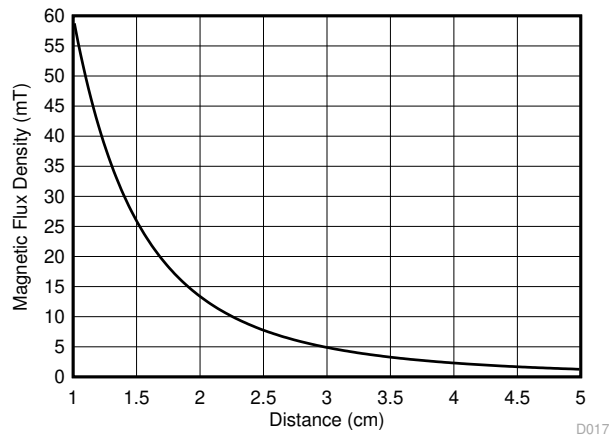

☒ 9-3. Magnetic Profile of a 1-cm Cube NdFeB Magnet

10 Power Supply Recommendations

The TMAG5123 is powered from 2.5-V to 38-V DC power supplies. A decoupling capacitor close to the device must be used to provide local energy with minimal inductance. TI recommends using a ceramic capacitor with a value of at least 0.01 μF .

11 Layout

11.1 Layout Guidelines

The bypass capacitor should be placed near the TMAG5123 to reduce noise.

Generally, using PCB copper planes underneath the TMAG5123 device has no effect on magnetic flux, and does not interfere with device performance. This is because copper is not a ferromagnetic material. However, if nearby system components contain iron or nickel, they may redirect magnetic flux in unpredictable ways.

11.2 Layout Example

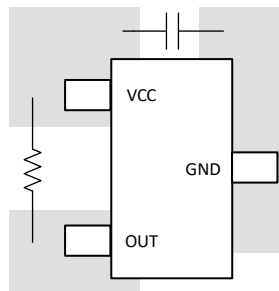

 11-1. TMAG5123 Layout Example

12 Device and Documentation Support

12.1 Receiving Notification of Documentation Updates

To receive notification of documentation updates, navigate to the device product folder on [ti.com](https://www.ti.com). Click on *Subscribe to updates* to register and receive a weekly digest of any product information that has changed. For change details, review the revision history included in any revised document.

12.2 サポート・リソース

TI E2E™ サポート・フォーラムは、エンジニアが検証済みの回答と設計に関するヒントをエキスパートから迅速かつ直接得ることができる場所です。既存の回答を検索したり、独自の質問をしたりすることで、設計に必要な支援を迅速に得ることができます。

リンクされているコンテンツは、該当する貢献者により、現状のまま提供されるものです。これらは TI の仕様を構成するものではなく、必ずしも TI の見解を反映したものではありません。TI の [使用条件](#) を参照してください。

12.3 Trademarks

TI E2E™ is a trademark of Texas Instruments.

すべての商標は、それぞれの所有者に帰属します。

12.4 Electrostatic Discharge Caution



This integrated circuit can be damaged by ESD. Texas Instruments recommends that all integrated circuits be handled with appropriate precautions. Failure to observe proper handling and installation procedures can cause damage.

ESD damage can range from subtle performance degradation to complete device failure. Precision integrated circuits may be more susceptible to damage because very small parametric changes could cause the device not to meet its published specifications.

12.5 Glossary

[TI Glossary](#) This glossary lists and explains terms, acronyms, and definitions.

13 Mechanical, Packaging, and Orderable Information

The following pages include mechanical, packaging, and orderable information. This information is the most current data available for the designated devices. This data is subject to change without notice and revision of this document. For browser-based versions of this data sheet, refer to the left-hand navigation.



DBZ0003A

PACKAGE OUTLINE
SOT-23 - 1.12 mm max height

SMALL OUTLINE TRANSISTOR

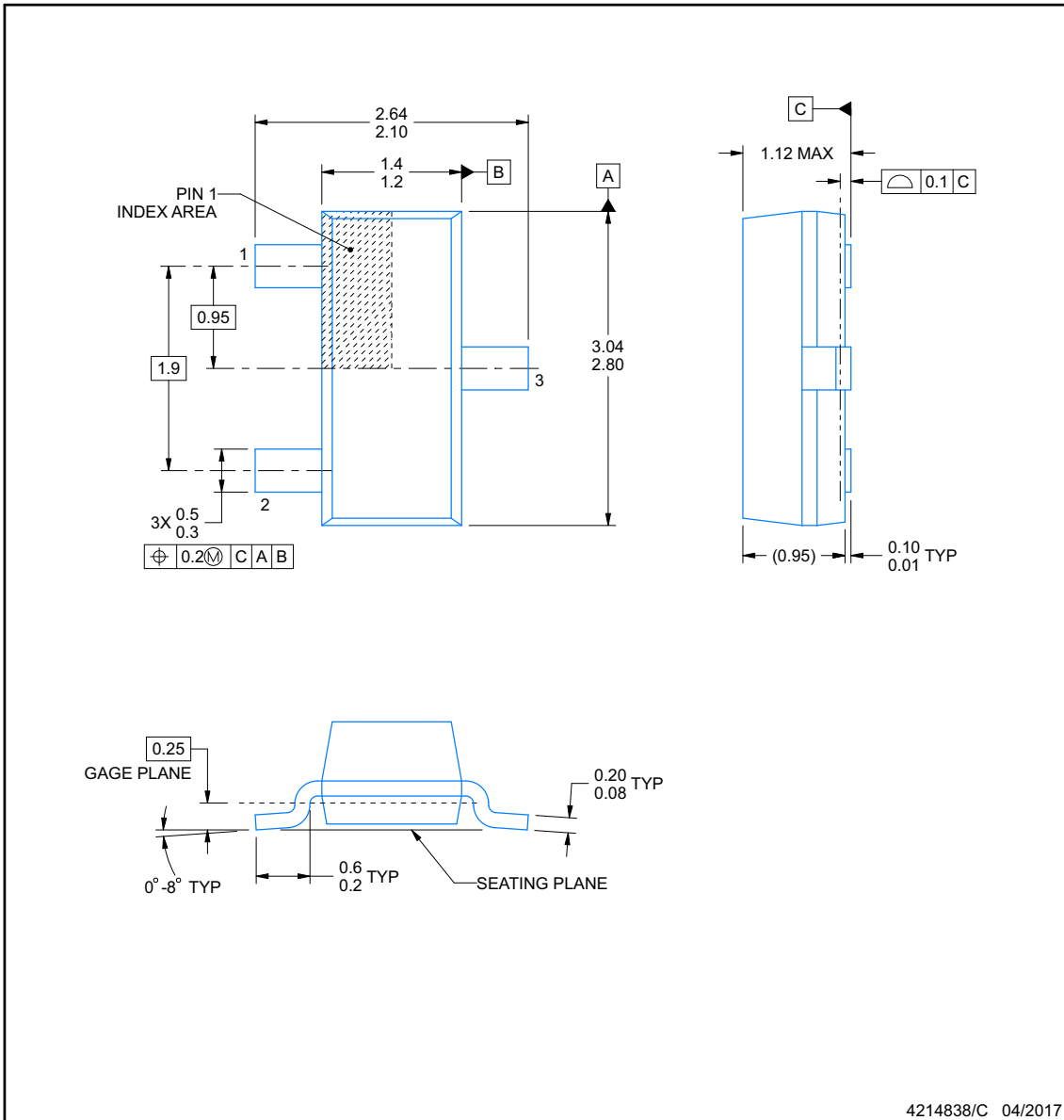

NOTES:

1. All linear dimensions are in millimeters. Any dimensions in parenthesis are for reference only. Dimensioning and tolerancing per ASME Y14.5M.
2. This drawing is subject to change without notice.
3. Reference JEDEC registration TO-236, except minimum foot length.

EXAMPLE BOARD LAYOUT

DBZ0003A

SOT-23 - 1.12 mm max height

SMALL OUTLINE TRANSISTOR

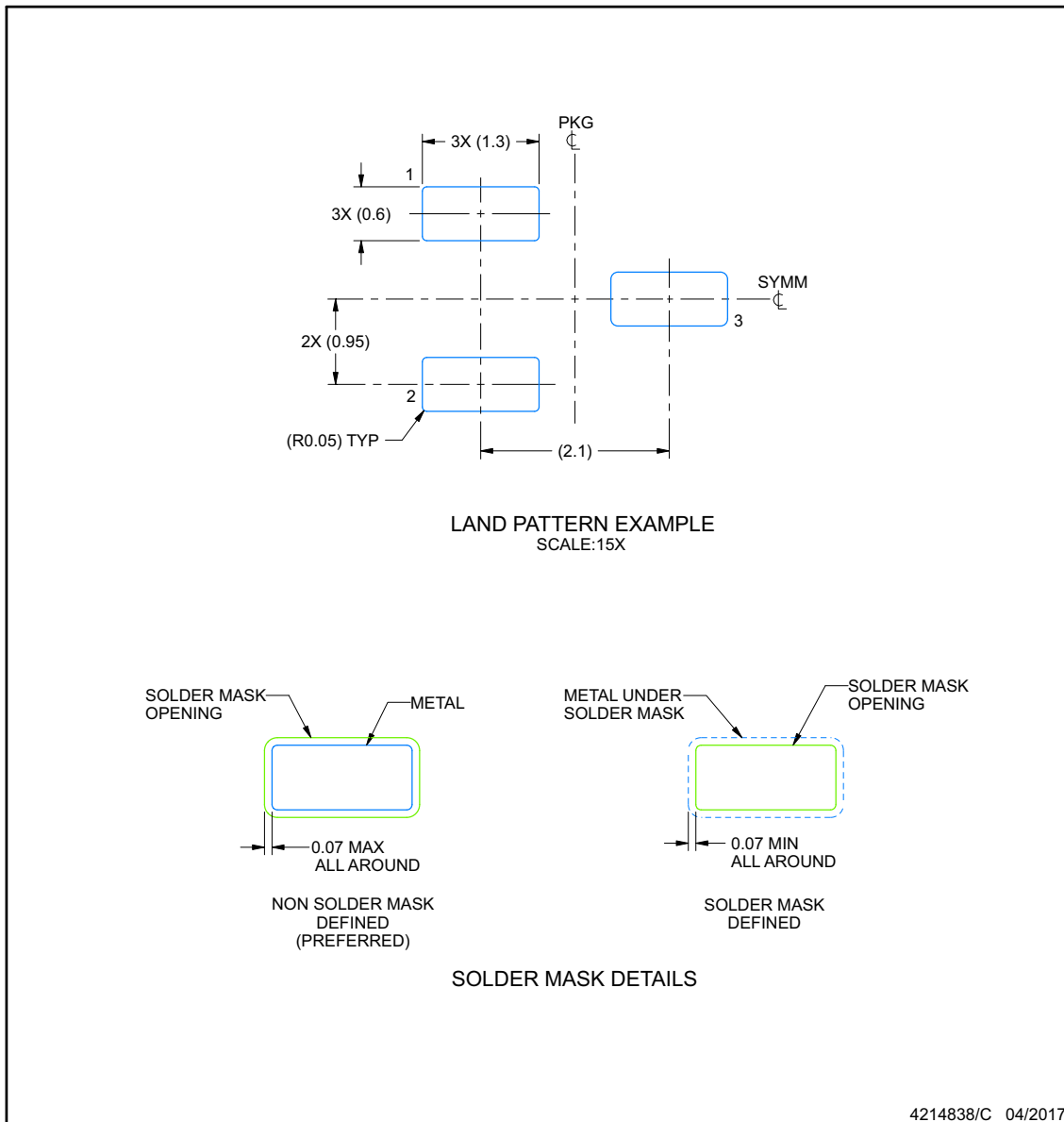

NOTES: (continued)

4. Publication IPC-7351 may have alternate designs.
5. Solder mask tolerances between and around signal pads can vary based on board fabrication site.

EXAMPLE STENCIL DESIGN

DBZ0003A

SOT-23 - 1.12 mm max height

SMALL OUTLINE TRANSISTOR

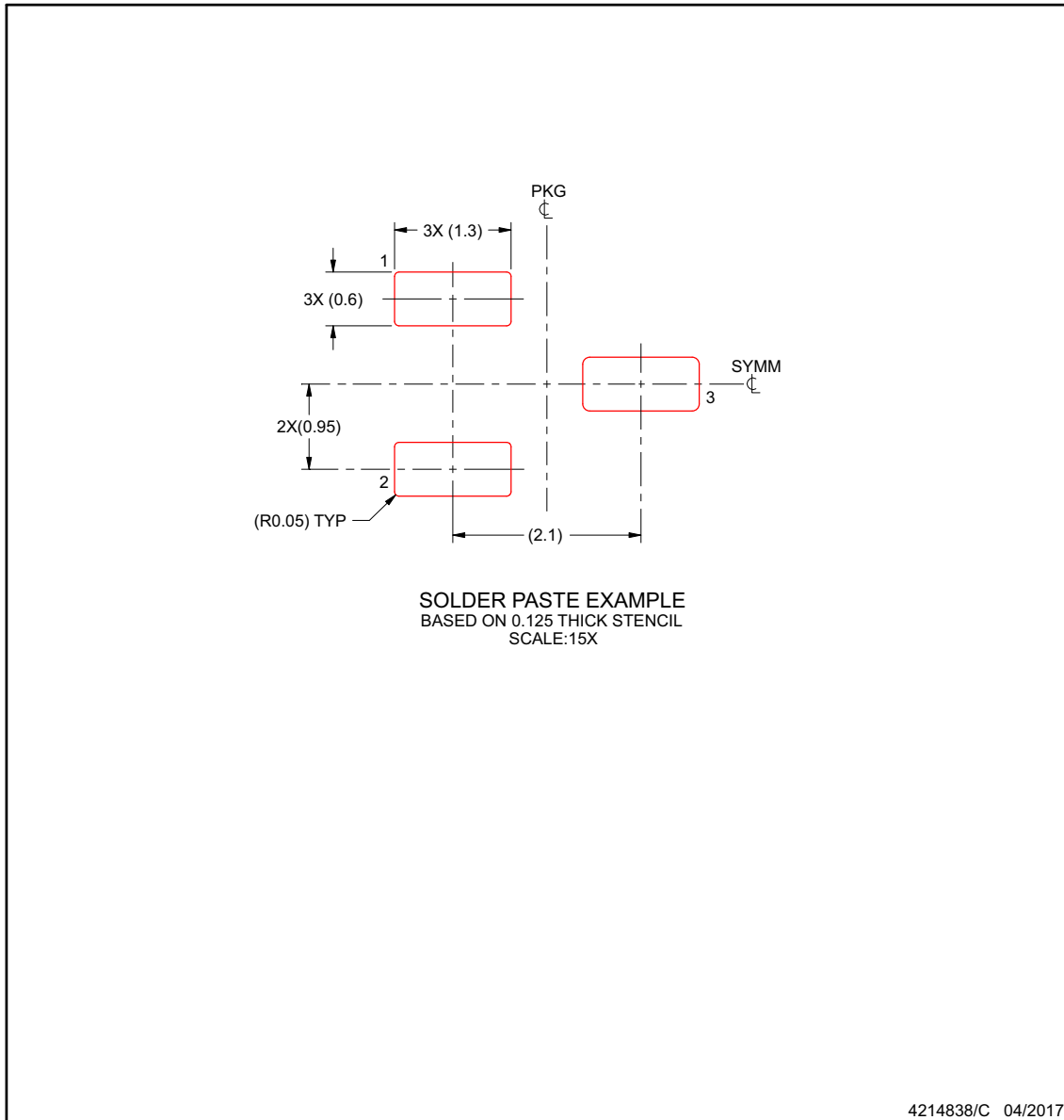

NOTES: (continued)

6. Laser cutting apertures with trapezoidal walls and rounded corners may offer better paste release. IPC-7525 may have alternate design recommendations.
7. Board assembly site may have different recommendations for stencil design.

PACKAGING INFORMATION

| Orderable Device | Status (1) | Package Type | Package Drawing | Pins | Package Qty | Eco Plan (2) | Lead finish/ Ball material (6) | MSL Peak Temp (3) | Op Temp (°C) | Device Marking (4/5) | Samples |
|------------------|---------------|--------------|-----------------|------|-------------|-----------------|--------------------------------------|----------------------|--------------|-------------------------|-------------------------|
| TMAG5123B1CQDBZR | ACTIVE | SOT-23 | DBZ | 3 | 3000 | RoHS & Green | SN | Level-3-260C-168 HR | -40 to 125 | 23B1 | Samples |
| TMAG5123C1CQDBZR | ACTIVE | SOT-23 | DBZ | 3 | 3000 | RoHS & Green | SN | Level-3-260C-168 HR | -40 to 125 | 23C1 | Samples |
| TMAG5123C1CQDBZT | OBSOLETE | SOT-23 | DBZ | 3 | | TBD | Call TI | Call TI | -40 to 125 | 23C1 | |
| TMAG5123D1CQDBZR | ACTIVE | SOT-23 | DBZ | 3 | 3000 | RoHS & Green | SN | Level-3-260C-168 HR | -40 to 125 | 23D1 | Samples |
| TMAG5123D1CQDBZT | OBSOLETE | SOT-23 | DBZ | 3 | | TBD | Call TI | Call TI | -40 to 125 | 23D1 | |

(1) The marketing status values are defined as follows:

ACTIVE: Product device recommended for new designs.

LIFEBUY: TI has announced that the device will be discontinued, and a lifetime-buy period is in effect.

NRND: Not recommended for new designs. Device is in production to support existing customers, but TI does not recommend using this part in a new design.

PREVIEW: Device has been announced but is not in production. Samples may or may not be available.

OBSOLETE: TI has discontinued the production of the device.

(2) **RoHS:** TI defines "RoHS" to mean semiconductor products that are compliant with the current EU RoHS requirements for all 10 RoHS substances, including the requirement that RoHS substance do not exceed 0.1% by weight in homogeneous materials. Where designed to be soldered at high temperatures, "RoHS" products are suitable for use in specified lead-free processes. TI may reference these types of products as "Pb-Free".

RoHS Exempt: TI defines "RoHS Exempt" to mean products that contain lead but are compliant with EU RoHS pursuant to a specific EU RoHS exemption.

Green: TI defines "Green" to mean the content of Chlorine (Cl) and Bromine (Br) based flame retardants meet JS709B low halogen requirements of <=1000ppm threshold. Antimony trioxide based flame retardants must also meet the <=1000ppm threshold requirement.

(3) MSL, Peak Temp. - The Moisture Sensitivity Level rating according to the JEDEC industry standard classifications, and peak solder temperature.

(4) There may be additional marking, which relates to the logo, the lot trace code information, or the environmental category on the device.

(5) Multiple Device Markings will be inside parentheses. Only one Device Marking contained in parentheses and separated by a "~" will appear on a device. If a line is indented then it is a continuation of the previous line and the two combined represent the entire Device Marking for that device.

(6) Lead finish/Ball material - Orderable Devices may have multiple material finish options. Finish options are separated by a vertical ruled line. Lead finish/Ball material values may wrap to two lines if the finish value exceeds the maximum column width.

Important Information and Disclaimer: The information provided on this page represents TI's knowledge and belief as of the date that it is provided. TI bases its knowledge and belief on information provided by third parties, and makes no representation or warranty as to the accuracy of such information. Efforts are underway to better integrate information from third parties. TI has taken and

continues to take reasonable steps to provide representative and accurate information but may not have conducted destructive testing or chemical analysis on incoming materials and chemicals. TI and TI suppliers consider certain information to be proprietary, and thus CAS numbers and other limited information may not be available for release.

In no event shall TI's liability arising out of such information exceed the total purchase price of the TI part(s) at issue in this document sold by TI to Customer on an annual basis.

OTHER QUALIFIED VERSIONS OF TMAG5123 :

- Automotive : [TMAG5123-Q1](#)

NOTE: Qualified Version Definitions:

- Automotive - Q100 devices qualified for high-reliability automotive applications targeting zero defects

DBZ0003A

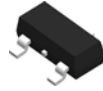

PACKAGE OUTLINE

SOT-23 - 1.12 mm max height

SMALL OUTLINE TRANSISTOR

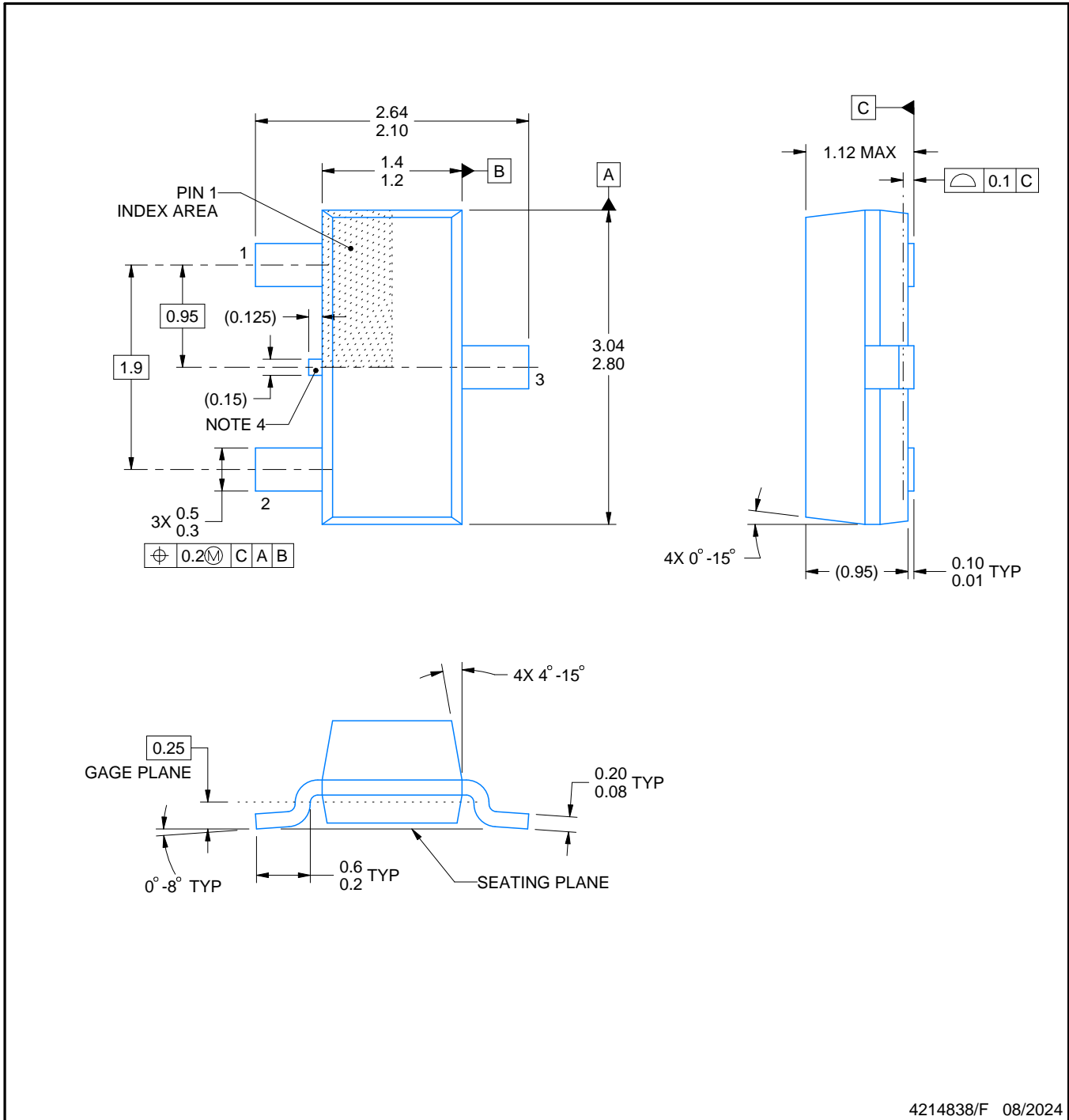

4214838/F 08/2024

NOTES:

1. All linear dimensions are in millimeters. Any dimensions in parenthesis are for reference only. Dimensioning and tolerancing per ASME Y14.5M.
2. This drawing is subject to change without notice.
3. Reference JEDEC registration TO-236, except minimum foot length.
4. Support pin may differ or may not be present.
5. Body dimensions do not include mold flash, protrusions, or gate burrs. Mold flash, protrusions, or gate burrs shall not exceed 0.25mm per side

EXAMPLE BOARD LAYOUT

DBZ0003A

SOT-23 - 1.12 mm max height

SMALL OUTLINE TRANSISTOR

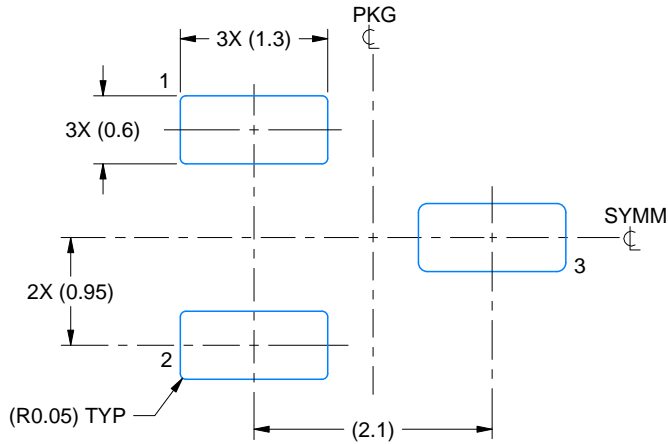

LAND PATTERN EXAMPLE
SCALE:15X

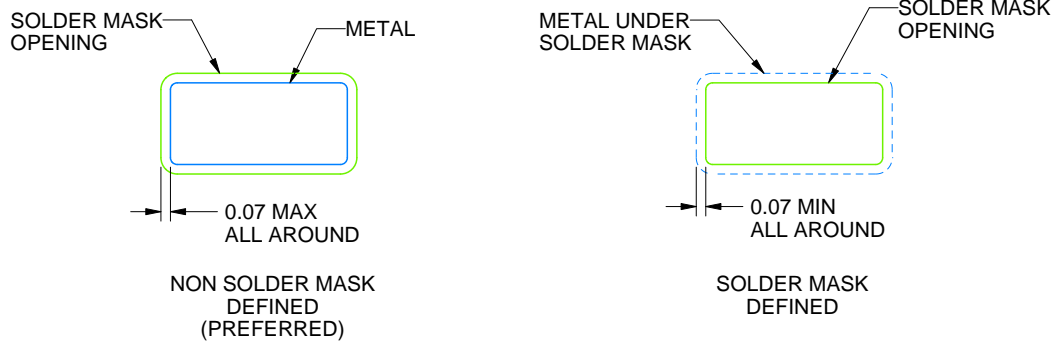

SOLDER MASK DETAILS

4214838/F 08/2024

NOTES: (continued)

5. Publication IPC-7351 may have alternate designs.
6. Solder mask tolerances between and around signal pads can vary based on board fabrication site.

EXAMPLE STENCIL DESIGN

DBZ0003A

SOT-23 - 1.12 mm max height

SMALL OUTLINE TRANSISTOR

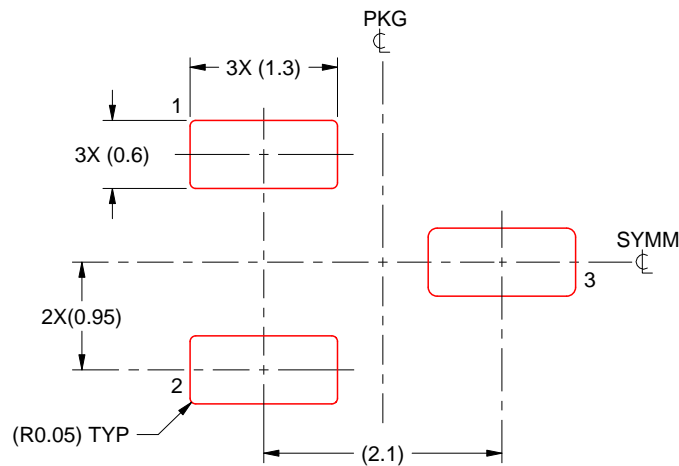

SOLDER PASTE EXAMPLE
BASED ON 0.125 THICK STENCIL
SCALE:15X

4214838/F 08/2024

NOTES: (continued)

7. Laser cutting apertures with trapezoidal walls and rounded corners may offer better paste release. IPC-7525 may have alternate design recommendations.
8. Board assembly site may have different recommendations for stencil design.

重要なお知らせと免責事項

TI は、技術データと信頼性データ(データシートを含みます)、設計リソース(リファレンス・デザインを含みます)、アプリケーションや設計に関する各種アドバイス、Web ツール、安全性情報、その他のリソースを、欠陥が存在する可能性のある「現状のまま」提供しており、商品性および特定目的に対する適合性の黙示保証、第三者の知的財産権の非侵害保証を含むいかなる保証も、明示的または黙示的にかかわらず拒否します。

これらのリソースは、TI 製品を使用する設計の経験を積んだ開発者への提供を意図したものです。(1) お客様のアプリケーションに適した TI 製品の選定、(2) お客様のアプリケーションの設計、検証、試験、(3) お客様のアプリケーションに該当する各種規格や、その他のあらゆる安全性、セキュリティ、規制、または他の要件への確実な適合に関する責任を、お客様のみが単独で負うものとし、

上記の各種リソースは、予告なく変更される可能性があります。これらのリソースは、リソースで説明されている TI 製品を使用するアプリケーションの開発の目的でのみ、TI はその使用をお客様に許諾します。これらのリソースに関して、他の目的で複製することや掲載することは禁止されています。TI や第三者の知的財産権のライセンスが付与されている訳ではありません。お客様は、これらのリソースを自身で使用した結果発生するあらゆる申し立て、損害、費用、損失、責任について、TI およびその代理人を完全に補償するものとし、TI は一切の責任を拒否します。

TI の製品は、[TI の販売条件](#)、または [ti.com](#) やかかる TI 製品の関連資料などのいずれかを通じて提供する適用可能な条項の下で提供されています。TI がこれらのリソースを提供することは、適用される TI の保証または他の保証の放棄の拡大や変更を意味するものではありません。

お客様がいかなる追加条項または代替条項を提案した場合でも、TI はそれらに異議を唱え、拒否します。

郵送先住所 : Texas Instruments, Post Office Box 655303, Dallas, Texas 75265
Copyright © 2024, Texas Instruments Incorporated