

TLV914x 18V、レール ツー レール入出力、125kHz 低消費電力 (7μA/チャンネル) オペアンプ

1 特長

- 広い電源電圧範囲: 2.7V~18V
- 低い静止電流: アンプ 1 個あたり 7μA
- レール ツー レール入出力
- 低いオフセット電圧: ±265μV (標準値)
- 低いオフセット電圧ドリフト: 0.2μV/°C (標準値)
- 高 PSRR: 140dB (標準値)
- 広い帯域幅: 125kHz GBW、ユニティゲインで安定
- 大出力電流の駆動: ±40mA
- 低い 1/f フリッカーノイズ: 3.4μVp-p (f = 0.1Hz~10Hz)
- 大きい同相除去: 108 dB
- 内部 RFI および EMI フィルタ付きの入力ピン
- 動作温度範囲: -40°C~125°C

2 アプリケーション

- 煙感知器、熱感知器
- フィールドトランスミッタとセンサ
 - 流量トランスミッタ
 - 圧カトランスミッタ
 - 温度トランスミッタ
 - レベルトランスミッタ
- 血糖値測定器
- 酸素濃縮器
- IP ネットワーク カメラ
- モーション検出器

3 概要

TLV914x ファミリー (TLV9141、TLV9142、および TLV9144) は、高電圧 (18V) レール・ツー・レール入出力

(RRIO) オペアンプのファミリーです。これらのデバイスは、静止電流がチャンネルあたり 7μA と低いため、低消費電力アプリケーションで優れた性能を実現します。

TLV914x ファミリーは、低いオフセット電圧 (±265μV、標準値)、低いオフセットドリフト (±0.2μV/°C、標準値)、40mA の短絡電流制限、140dB の高い PSRR、メイン入力ペア内の高電圧動作に対する 108dB の高い CMRR など、優れた DC 精度を提供します。また、これらのデバイスは、2.7V~18V の広い電源電圧範囲で動作します。これにより、TLV914x は高電圧産業用アプリケーション向けの柔軟で堅牢な高性能オペアンプになります。

さらに、これらのデバイスは、125kHz のゲイン帯域幅積を備え、3.4μV_{peak-to-peak} (0.1Hz~10Hz) という低い 1/f フリッカー ノイズを実現しています。このファミリーは、30 度以上の位相マージンを維持しながら、最大 350nF の容量性負荷を直接駆動できるように設計されています。TLV914x オペアンプ ファミリーは複数の業界標準パッケージで供給され、デバイスは -40°C~125°C で動作が規定されています。

パッケージ情報

部品番号	チャンネル数	パッケージ ⁽¹⁾	パッケージ サイズ ⁽²⁾
TLV9141	シングル	DBV (SOT-23, 5)	2.9mm × 2.8mm
		D (SOIC, 8)	4.9mm × 6mm
TLV9142	デュアル	PW (TSSOP, 8)	3mm × 6.4mm
		D (SOIC, 8)	4.9mm × 6mm
TLV9144	クワッド	D (SOIC, 14)	8.65mm × 6mm
		PW (TSSOP, 14)	5mm × 6.4mm
		N (PDIP, 14)	19.3mm × 7.94mm

- (1) 詳細については、[セクション 10](#) を参照してください。
- (2) パッケージ サイズ (長さ × 幅) は公称値で、該当する場合はピンも含まれます。

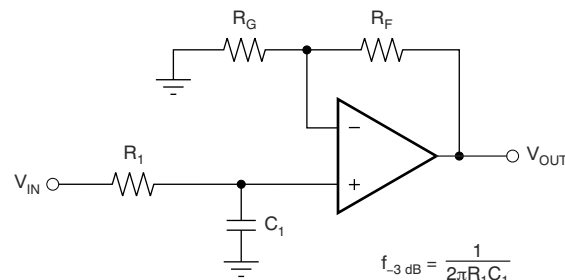

$$\frac{V_{OUT}}{V_{IN}} = \left(1 + \frac{R_F}{R_G}\right) \left(\frac{1}{1 + sR_1C_1}\right)$$

シングル ポールのローパス フィルタ



Table of Contents

1 特長	1	6.4 Device Functional Modes.....	27
2 アプリケーション	1	7 Application and Implementation	28
3 概要	1	7.1 Application Information.....	28
4 Pin Configuration and Functions	3	7.2 Typical Applications.....	28
5 Specifications	6	7.3 Power Supply Recommendations.....	29
5.1 Absolute Maximum Ratings.....	6	7.4 Layout.....	30
5.2 ESD Ratings.....	6	8 Device and Documentation Support	32
5.3 Recommended Operating Conditions.....	6	8.1 Device Support.....	32
5.4 Thermal Information for Single Channel.....	7	8.2 Documentation Support.....	32
5.5 Thermal Information for Dual Channel.....	7	8.3 ドキュメントの更新通知を受け取る方法.....	32
5.6 Thermal Information for Quad Channel.....	7	8.4 サポート・リソース.....	32
5.7 Electrical Characteristics.....	8	8.5 Trademarks.....	32
5.8 Typical Characteristics.....	10	8.6 静電気放電に関する注意事項.....	32
6 Detailed Description	18	8.7 用語集.....	33
6.1 Overview.....	18	9 Revision History	33
6.2 Functional Block Diagram.....	18	10 Mechanical, Packaging, and Orderable Information	33
6.3 Feature Description.....	19		

4 Pin Configuration and Functions



図 4-1. TLV9141 DBV Package
5-Pin SOT-23
(Top View)



NC- no internal connection

図 4-2. TLV9141 D Package
8-Pin SOIC
(Top View)

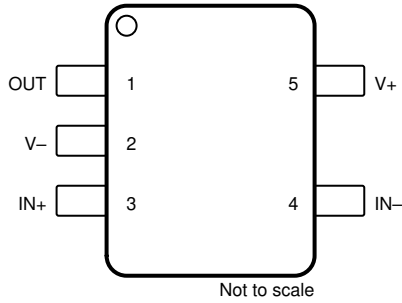
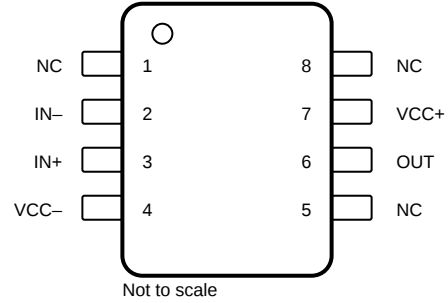
表 4-1. Pin Functions: TLV9141

PIN			TYPE ⁽¹⁾	DESCRIPTION
NAME	DBV	D		
IN-	4	2	I	Inverting input
IN+	3	3	I	Noninverting input
NC	—	1, 5, 8	—	Do not connect
OUT	1	6	O	Output
V-	2	4	—	Negative (lowest) power supply
V+	5	7	—	Positive (highest) power supply

(1) I = input, O = output



図 4-3. TLV9142 D, PW, and N Package, 8-Pin SOIC, TSSOP, and PDIP (Top View)

表 4-2. Pin Functions: TLV9142

PIN		TYPE ⁽¹⁾	DESCRIPTION
NAME	NO.		
IN1+	3	I	Noninverting input, channel 1
IN1-	2	I	Inverting input, channel 1
IN2+	5	I	Noninverting input, channel 2
IN2-	6	I	Inverting input, channel 2
OUT1	1	O	Output, channel 1
OUT2	7	O	Output, channel 2
V+	8	—	Positive (highest) power supply
V-	4	—	Negative (lowest) power supply

(1) I = input, O = output

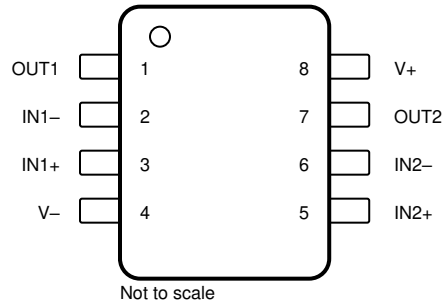
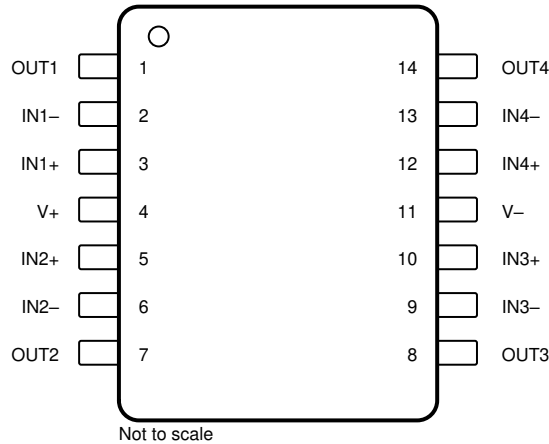

Not to scale

**図 4-4. TLV9144 D and PW Package
 14-Pin SOIC and TSSOP
 (Top View)**

表 4-3. Pin Functions: TLV9144

PIN		TYPE ⁽¹⁾	DESCRIPTION
NAME	NO.		
IN1+	3	I	Noninverting input, channel 1
IN1–	2	I	Inverting input, channel 1
IN2+	5	I	Noninverting input, channel 2
IN2–	6	I	Inverting input, channel 2
IN3+	10	I	Noninverting input, channel 3
IN3–	9	I	Inverting input, channel 3
IN4+	12	I	Noninverting input, channel 4
IN4–	13	I	Inverting input, channel 4
OUT1	1	O	Output, channel 1
OUT2	7	O	Output, channel 2
OUT3	8	O	Output, channel 3
OUT4	14	O	Output, channel 4
V+	4	—	Positive (highest) power supply
V–	11	—	Negative (lowest) power supply

(1) I = input, O = output

5 Specifications

5.1 Absolute Maximum Ratings

over operating ambient temperature range (unless otherwise noted) ⁽¹⁾

		MIN	MAX	UNIT
Supply voltage, $V_S = (V+) - (V-)$		0	20	V
Signal input pins	Common-mode voltage ⁽³⁾	$(V-) - 0.5$	$(V+) + 0.5$	V
	Differential voltage ⁽³⁾		$V_S + 0.2$	V
	Current ⁽³⁾	-10	10	mA
Output short-circuit ⁽²⁾		Continuous		
Operating ambient temperature, T_A		-55	150	°C
Junction temperature, T_J			150	°C
Storage temperature, T_{stg}		-65	150	°C

- (1) Operating the device beyond the ratings listed under *Absolute Maximum Ratings* will cause permanent damage to the device. These are stress ratings only, based on process and design limitations, and this device has not been designed to function outside the conditions indicated under *Recommended Operating Conditions*. Exposure to any condition outside *Recommended Operating Conditions* for extended periods, including absolute-maximum-rated conditions, may affect device reliability and performance.
- (2) Short-circuit to ground, one amplifier per package. This device has been designed to limit *electrical* damage due to excessive output current, but extended short-circuit current, especially with higher supply voltage, can cause excessive heating and eventual *thermal* destruction.
- (3) Input pins are diode-clamped to the power-supply rails. Input signals that may swing more than 0.5V beyond the supply rails must be current limited to 10mA or less.

5.2 ESD Ratings

			VALUE	UNIT
$V_{(ESD)}$	Electrostatic discharge	Human body model (HBM), per ANSI/ESDA/JEDEC JS-001 ⁽¹⁾	±2500	V
		Charged device model (CDM), per ANSI/ESDA/JEDEC JS-002 ⁽²⁾	±1500	

- (1) JEDEC document JEP155 states that 500V HBM allows safe manufacturing with a standard ESD control process.
- (2) JEDEC document JEP157 states that 250V CDM allows safe manufacturing with a standard ESD control process.

5.3 Recommended Operating Conditions

over operating ambient temperature range (unless otherwise noted)

		MIN	MAX	UNIT
V_S	Supply voltage, $(V+) - (V-)$	2.7	18	V
V_I	Input voltage range	$(V-) - 0.2$	$(V+) + 0.2$	V
T_A	Specified temperature	-40	125	°C

5.4 Thermal Information for Single Channel

THERMAL METRIC ⁽¹⁾		TLV9141		UNIT
		DBV (SOT-23)	D (SOIC)	
		5 PINS	8 PINS	
R _{θJA}	Junction-to-ambient thermal resistance	196.7	139.2	°C/W
R _{θJC(top)}	Junction-to-case (top) thermal resistance	94.1	77.9	°C/W
R _{θJB}	Junction-to-board thermal resistance	63.3	88.4	°C/W
ψ _{JT}	Junction-to-top characterization parameter	30.8	24.2	°C/W
ψ _{JB}	Junction-to-board characterization parameter	62.9	87.2	°C/W
R _{θJC(bot)}	Junction-to-case (bottom) thermal resistance	N/A	N/A	°C/W

(1) For more information about traditional and new thermal metrics, see the [Semiconductor and IC Package Thermal Metrics](#) application note.

5.5 Thermal Information for Dual Channel

THERMAL METRIC ⁽¹⁾		TLV9142		UNIT
		PW (TSSOP)	D (SOIC)	
		8 PINS	8 PINS	
R _{θJA}	Junction-to-ambient thermal resistance	162.2	129.2	°C/W
R _{θJC(top)}	Junction-to-case (top) thermal resistance	67.1	68.2	°C/W
R _{θJB}	Junction-to-board thermal resistance	101.4	78.5	°C/W
ψ _{JT}	Junction-to-top characterization parameter	7.2	17.0	°C/W
ψ _{JB}	Junction-to-board characterization parameter	99.8	77.4	°C/W
R _{θJC(bot)}	Junction-to-case (bottom) thermal resistance	N/A	N/A	°C/W

(1) For more information about traditional and new thermal metrics, see the [Semiconductor and IC Package Thermal Metrics](#) application note.

5.6 Thermal Information for Quad Channel

THERMAL METRIC ⁽¹⁾		TLV9144			UNIT
		PW (TSSOP)	D (SOIC)	N (PDIP)	
		14 PINS	14 PINS	14 PINS	
R _{θJA}	Junction-to-ambient thermal resistance	114.2	90.4	72.3	°C/W
R _{θJC(top)}	Junction-to-case (top) thermal resistance	44.7	50.6	50.6	°C/W
R _{θJB}	Junction-to-board thermal resistance	70.0	48.5	46.4	°C/W
ψ _{JT}	Junction-to-top characterization parameter	2.6	11.6	28.3	°C/W
ψ _{JB}	Junction-to-board characterization parameter	69.3	48.0	45.8	°C/W
R _{θJC(bot)}	Junction-to-case (bottom) thermal resistance	N/A	N/A	N/A	°C/W

(1) For more information about traditional and new thermal metrics, see the [Semiconductor and IC Package Thermal Metrics](#) application note.

5.7 Electrical Characteristics

For $V_S = (V+) - (V-) = 2.7V$ to $18V$ ($\pm 1.35V$ to $\pm 9V$) at $T_A = 25^\circ C$, $R_L = 10k\Omega$ connected to $V_S / 2$, $V_{CM} = V_S / 2$, and $V_{OUT} = V_S / 2$, unless otherwise noted.

PARAMETER		TEST CONDITIONS		MIN	TYP	MAX	UNIT
OFFSET VOLTAGE							
V_{OS}	Input offset voltage	$V_{CM} = V-$		± 0.265	± 1		mV
			$T_A = -40^\circ C$ to $125^\circ C$			± 1.5	
dV_{OS}/dT	Input offset voltage drift		$T_A = -40^\circ C$ to $125^\circ C$	± 0.2			$\mu V/^\circ C$
PSRR	Input offset voltage versus power supply	$V_{CM} = V-, V_S = 5V$ to $18V$	$T_A = -40^\circ C$ to $125^\circ C$	± 0.112	± 1		$\mu V/V$
				139	115		dB
	$V_{CM} = V-, V_S = 2.7V$ to $18V^{(1)}$	$T_A = -40^\circ C$ to $125^\circ C$	± 0.1	± 1.8		$\mu V/V$	
			140	114		dB	
	Channel separation	$f = 0Hz$		5			$\mu V/V$
				106			dB
INPUT BIAS CURRENT							
I_B	Input bias current ^{(1) (2)}			± 0.5	± 10		pA
I_{OS}	Input offset current ^{(1) (2)}			± 0.5	± 10		pA
NOISE							
E_N	Input voltage noise	$f = 0.1Hz$ to $10Hz$		3.4			μV_{PP}
				0.5			μV_{RMS}
e_N	Input voltage noise density	$f = 1kHz$		50			nV/\sqrt{Hz}
i_N	Input current noise	$f = 1kHz$		0.5			fA/\sqrt{Hz}
INPUT VOLTAGE RANGE							
V_{CM}	Common-mode voltage range			$(V-) - 0.2$	$(V+) + 0.2$		V
CMRR	Common-mode rejection ratio	$V_S = 18V, (V-) - 0.1V < V_{CM} < (V+) - 2V$ (Main input pair)		99	108		dB
			$T_A = -40^\circ C$ to $125^\circ C$	99			
		$V_S = 5V, (V-) - 0.1V < V_{CM} < (V+) - 2V$ (Main input pair)		86	94		
			$T_A = -40^\circ C$ to $125^\circ C$	85			
		$V_S = 2.7V, (V-) - 0.1V < V_{CM} < (V+) - 2V$ (Main input pair) ⁽¹⁾		75	85		
			$T_A = -40^\circ C$ to $125^\circ C$	74			
		$V_S = 2.7V$ to $18V, (V+) - 1V < V_{CM} < (V+) + 0.1V$ (Aux input pair) ⁽¹⁾			95		
$T_A = -40^\circ C$ to $125^\circ C$	72						
$V_S = 18V, (V-) - 0.2V < V_{CM} < (V+) + 0.2V$ (Both input pairs) ⁽¹⁾		80	91				
	$T_A = -40^\circ C$ to $125^\circ C$	79					
	$(V+) - 2V < V_{CM} < (V+) - 1V$	$T_A = -40^\circ C$ to $125^\circ C$		See Input Offset Voltage vs Common-Mode Voltage			
INPUT CAPACITANCE							
Z_{ID}	Differential			500 3			GΩ pF
Z_{ICM}	Common-mode			5 1			TΩ pF

For $V_S = (V+) - (V-) = 2.7V$ to $18V$ ($\pm 1.35V$ to $\pm 9V$) at $T_A = 25^\circ C$, $R_L = 10k\Omega$ connected to $V_S / 2$, $V_{CM} = V_S / 2$, and $V_{OUT} = V_S / 2$, unless otherwise noted.

PARAMETER		TEST CONDITIONS		MIN	TYP	MAX	UNIT
OPEN-LOOP GAIN							
A_{OL}	Open-loop voltage gain	$V_S = 18V, V_{CM} = V-, (V-) + 0.1V < V_O < (V+) - 0.1V$	$T_A = -40^\circ C$ to $125^\circ C$	110	135		dB
					125		
		$V_S = 5V, V_{CM} = V-, (V-) + 0.1V < V_O < (V+) - 0.1V$	$T_A = -40^\circ C$ to $125^\circ C$	105	130	125	
		$V_S = 2.7V, V_{CM} = V-, (V-) + 0.1V < V_O < (V+) - 0.1V^{(1)}$	$T_A = -40^\circ C$ to $125^\circ C$	100	120	115	
FREQUENCY RESPONSE							
GBW	Gain-bandwidth product	$R_L = 1M\Omega$			125		kHz
SR	Slew rate	$V_S = 18V, G = +1, C_L = 20pF$			0.1		V/ μs
t_s	Settling time	To 0.01%, $V_S = 18V, V_{STEP} = 10V, G = +1, C_L = 20pF$			135		μs
		To 0.01%, $V_S = 18V, V_{STEP} = 2V, G = +1, C_L = 20pF$			68		
		To 0.1%, $V_S = 18V, V_{STEP} = 10V, G = +1, C_L = 20pF$			121		
		To 0.1%, $V_S = 18V, V_{STEP} = 2V, G = +1, C_L = 20pF$			51		
PM	Phase margin	$G = +1, R_L = 100k\Omega, C_L = 100pF$			40		$^\circ$
$t_{overload}$	Overload recovery time	$V_{IN} \times \text{gain} > V_S$			35		μs
THD+N	Total harmonic distortion + noise ⁽³⁾	$V_S = 18V, V_O = 1V_{RMS}, G = 1, f = 1kHz, R_L = 1M\Omega$			0.07		%
					73		dB
		$V_S = 18V, V_O = 1V_{RMS}, G = 1, f = 1kHz, R_L = 100k\Omega$			0.02		%
					63		dB
OUTPUT							
	Voltage output swing from rail	Positive and negative rail headroom	$V_S = 18V, R_L = \text{no load}^{(1)}$	5	10		mV
			$V_S = 18V, R_L = 10k\Omega$	50	60		
			$V_S = 18V, R_L = 2k\Omega$	266	300		
			$V_S = 2.7V, R_L = \text{no load}^{(1)}$	1	5		
			$V_S = 2.7V, R_L = 10k\Omega$	12	20		
			$V_S = 2.7V, R_L = 2k\Omega$	58	80		
I_{SC}	Short-circuit current				± 40		mA
C_{LOAD}	Capacitive load drive			See Phase Margin vs Capacitive Load			pF
Z_O	Open-loop output impedance	$I_O = 0A$		See Open-Loop Output Impedance vs Frequency			Ω
POWER SUPPLY							
I_Q	Quiescent current per amplifier	$V_{CM} = V-, I_O = 0A$			7	9	μA
				$T_A = -40^\circ C$ to $125^\circ C$		9.5	

- (1) Max value is specified by characterization only.
- (2) Input differential voltages greater than 2.5V can cause increased I_B .
- (3) Third-order filter; bandwidth = 80kHz at -3 dB.

5.8 Typical Characteristics

at $T_A = 25^\circ\text{C}$, $V_S = \pm 9\text{V}$, $V_{CM} = V_S / 2$, $R_{LOAD} = 10\text{k}\Omega$ (unless otherwise noted)

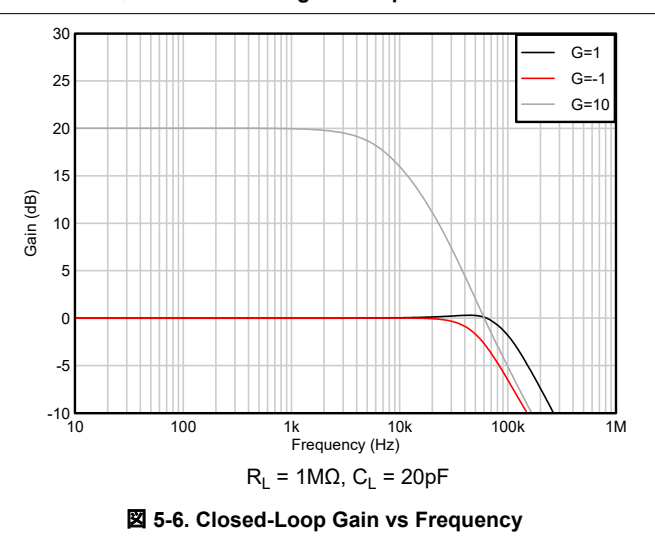
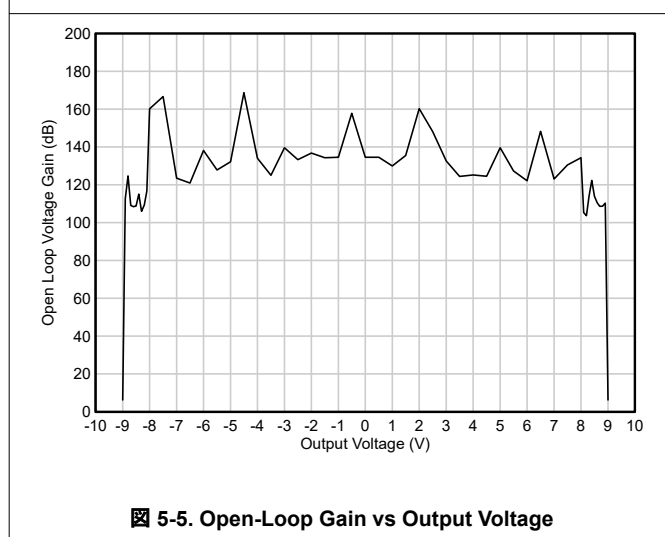
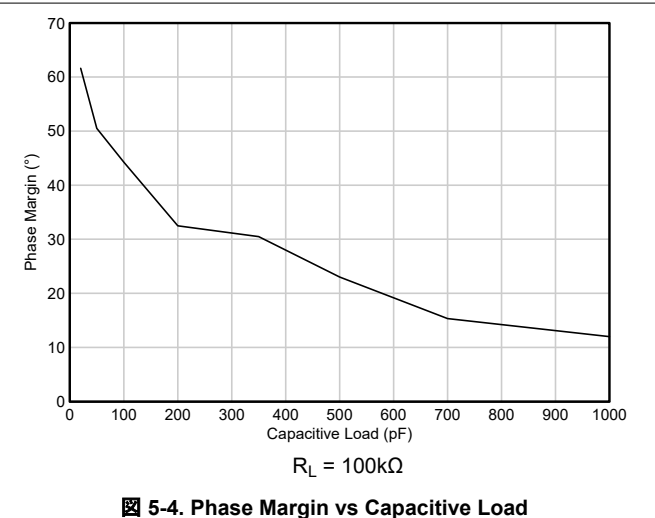
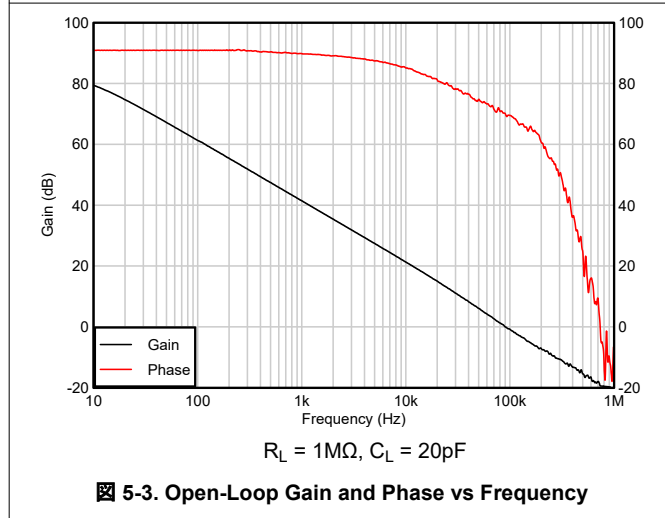
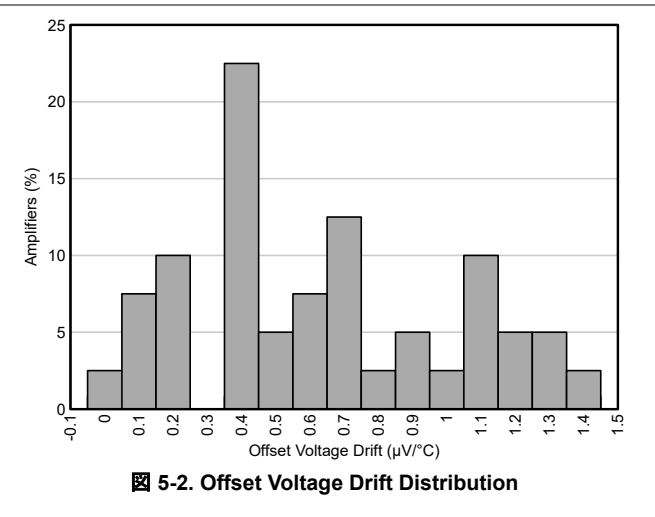
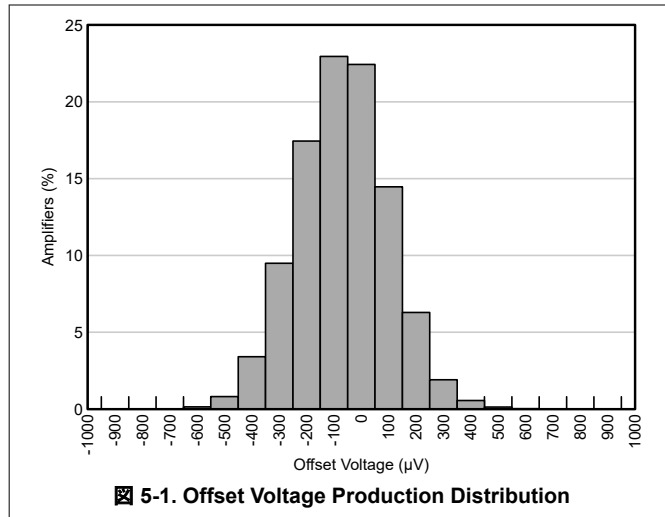

5.8 Typical Characteristics (continued)

at $T_A = 25^\circ\text{C}$, $V_S = \pm 9\text{V}$, $V_{CM} = V_S / 2$, $R_{LOAD} = 10\text{k}\Omega$ (unless otherwise noted)

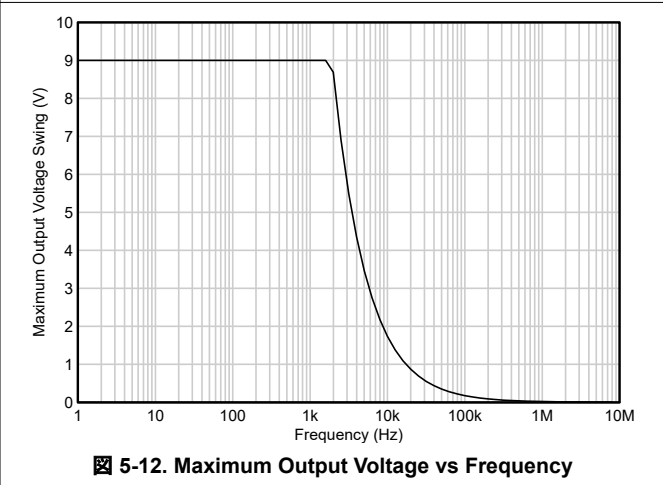
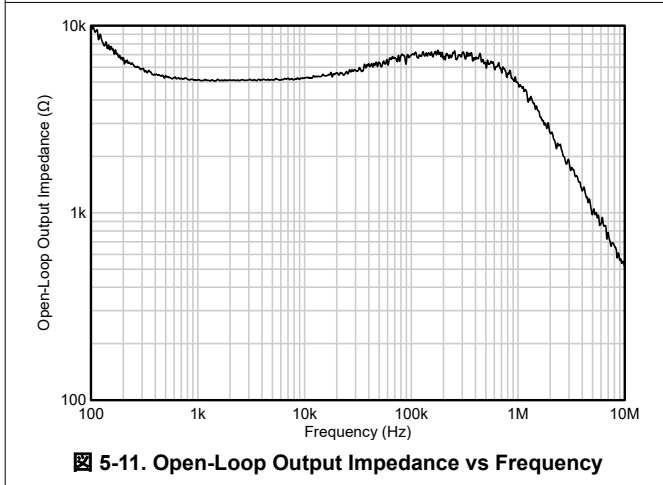
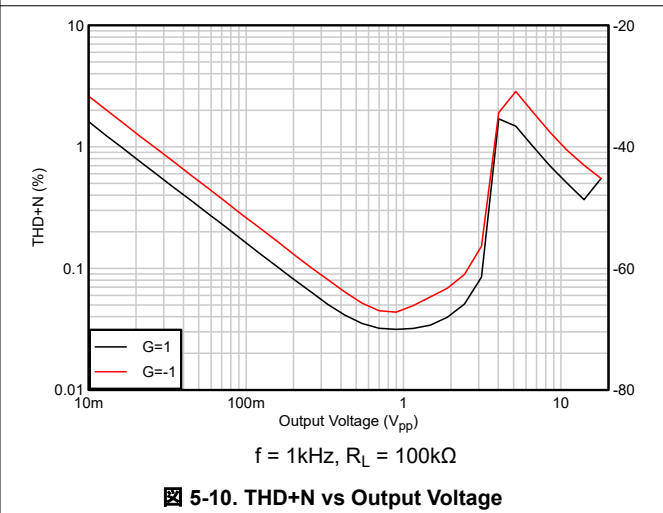
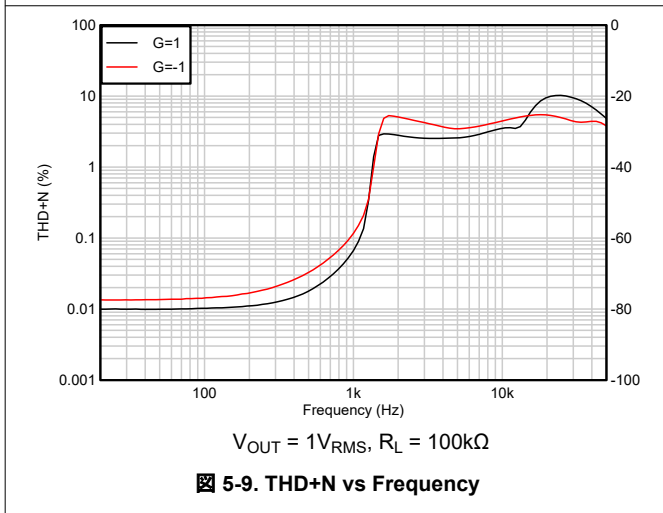
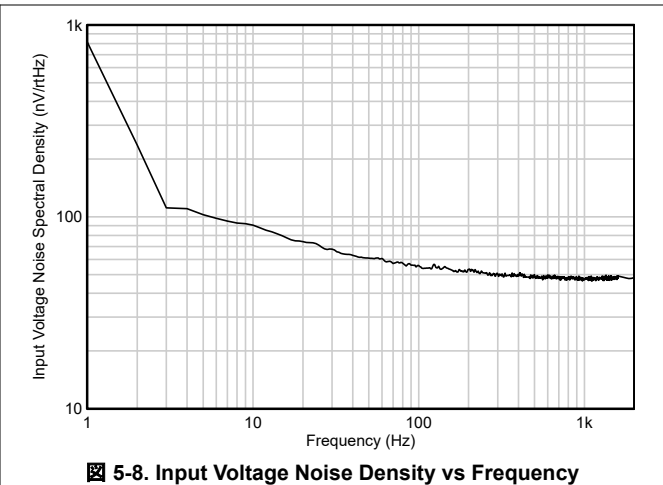
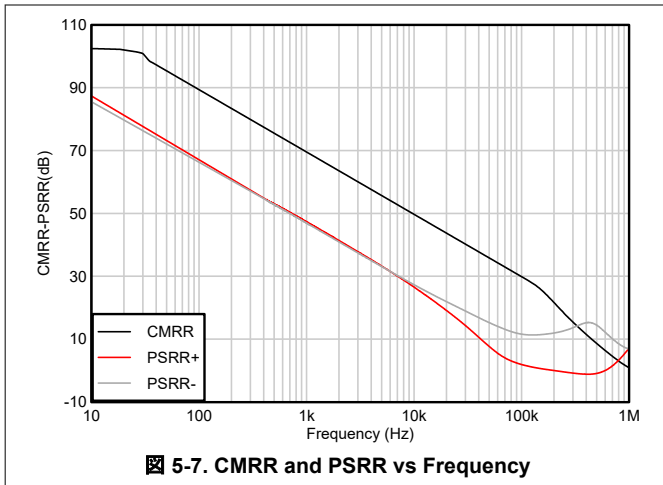

5.8 Typical Characteristics (continued)

at $T_A = 25^\circ\text{C}$, $V_S = \pm 9\text{V}$, $V_{CM} = V_S / 2$, $R_{LOAD} = 10\text{k}\Omega$ (unless otherwise noted)

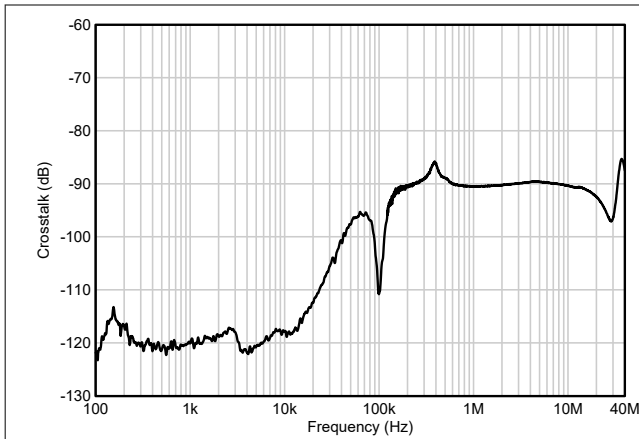

Figure 5-13. Crosstalk vs Frequency

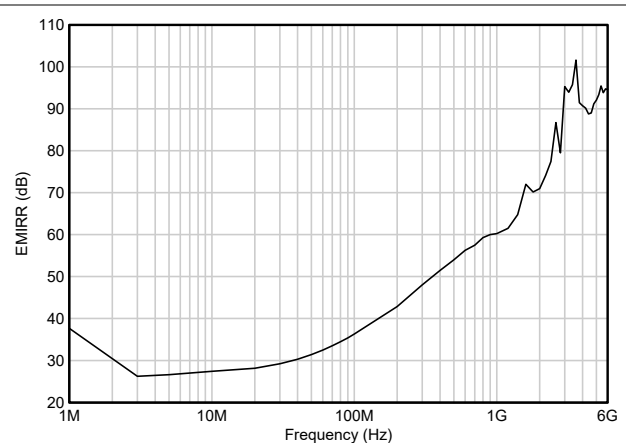

Figure 5-14. EMIRR vs Frequency

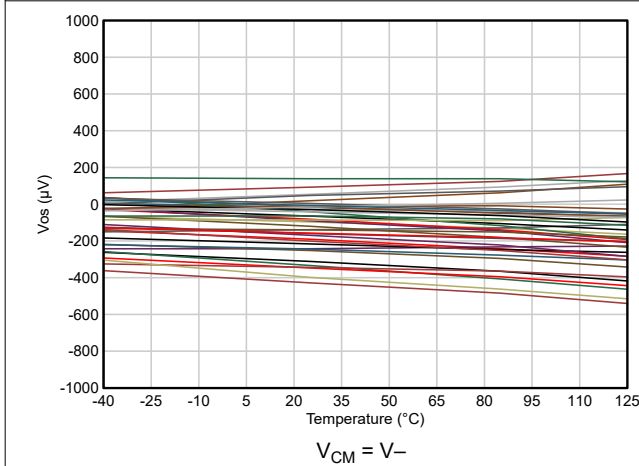

Figure 5-15. Input Offset Voltage vs Temperature

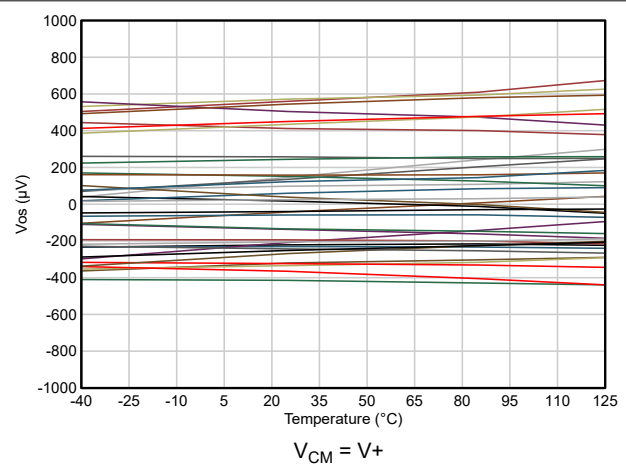

Figure 5-16. Input Offset Voltage vs Temperature

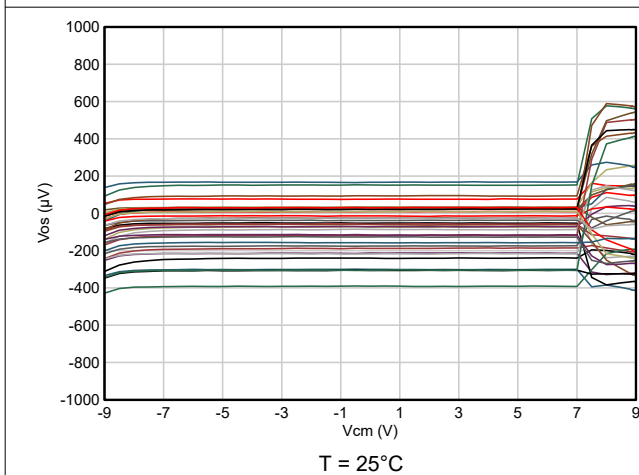

Figure 5-17. Input Offset Voltage vs Common-Mode Voltage

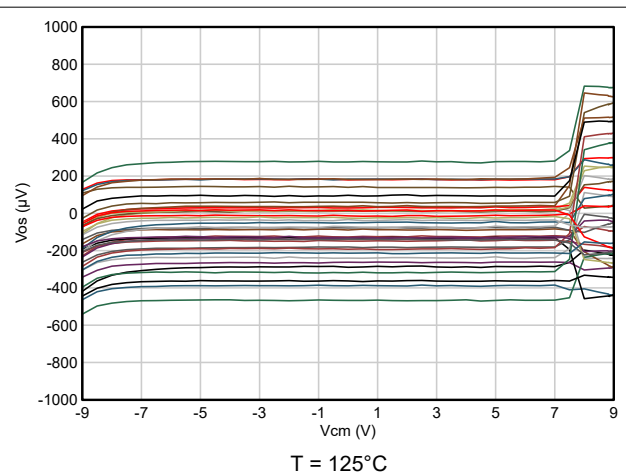
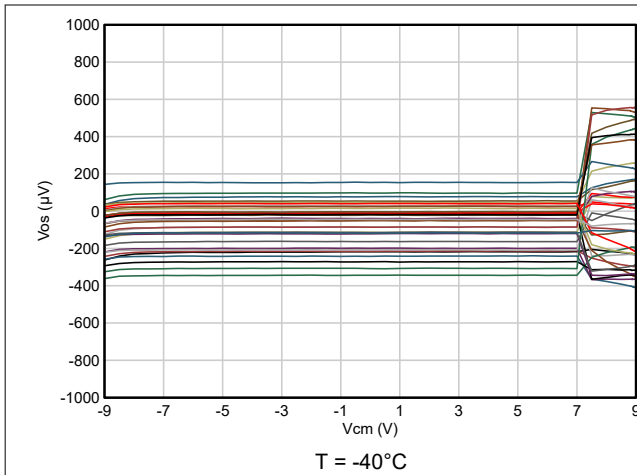

Figure 5-18. Input Offset Voltage vs Common-Mode Voltage

5.8 Typical Characteristics (continued)

at $T_A = 25^\circ\text{C}$, $V_S = \pm 9\text{V}$, $V_{CM} = V_S / 2$, $R_{LOAD} = 10\text{k}\Omega$ (unless otherwise noted)



5-19. Input Offset Voltage vs Common-Mode Voltage

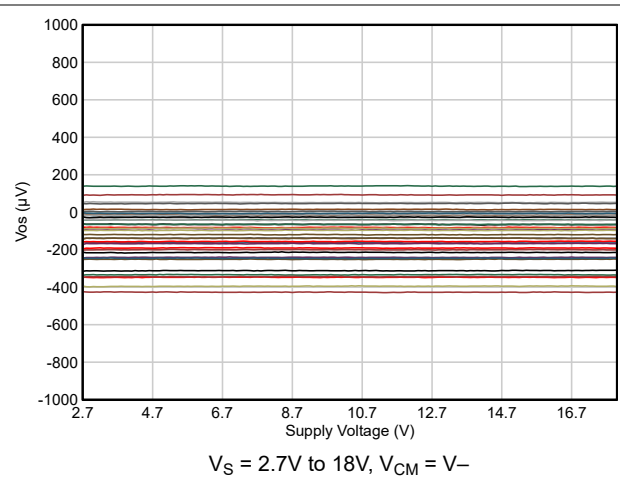

5-20. Input Offset Voltage vs Supply Voltage

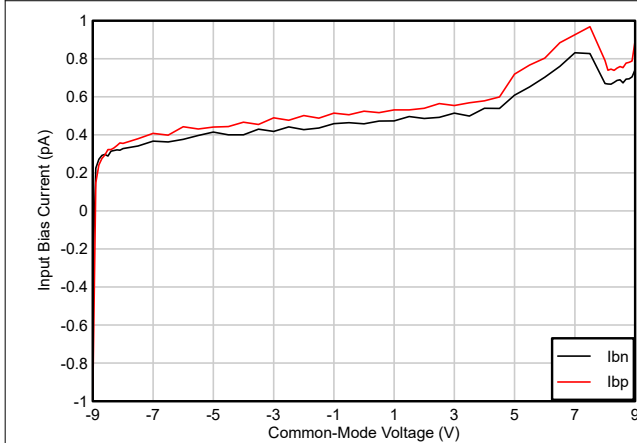

5-21. Input Bias Current vs Common-Mode Voltage

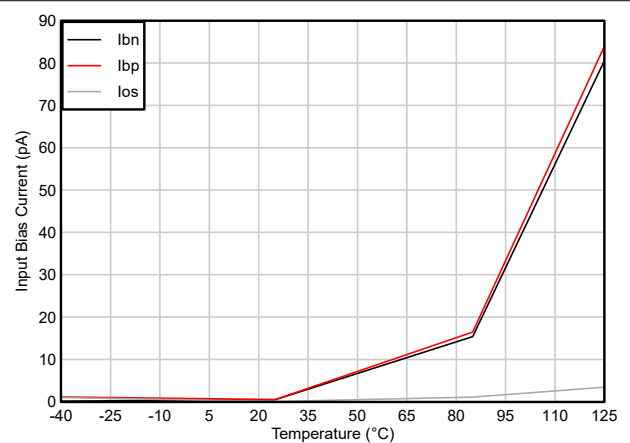

5-22. Input Bias Current vs Temperature

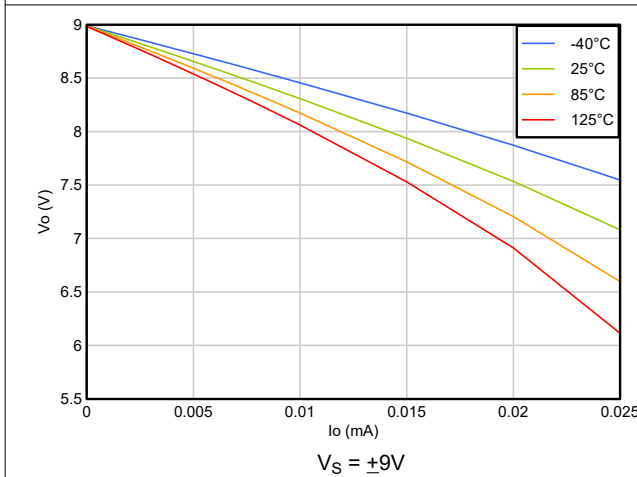

5-23. Output Voltage Swing vs Output Current (Sourcing)

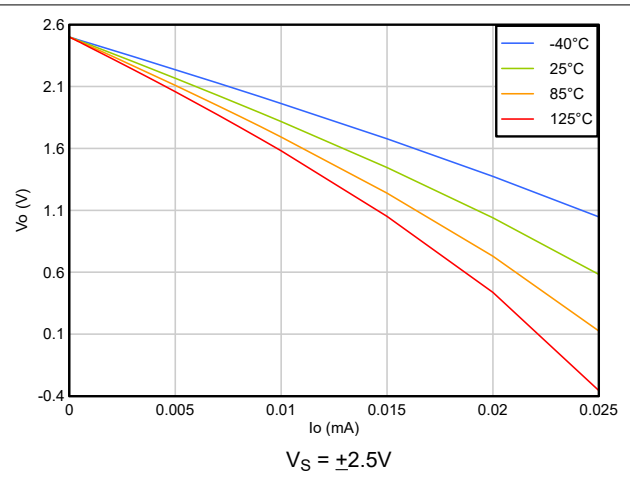

5-24. Output Voltage Swing vs Output Current (Sourcing)

5.8 Typical Characteristics (continued)

at $T_A = 25^\circ\text{C}$, $V_S = \pm 9\text{V}$, $V_{CM} = V_S / 2$, $R_{LOAD} = 10\text{k}\Omega$ (unless otherwise noted)

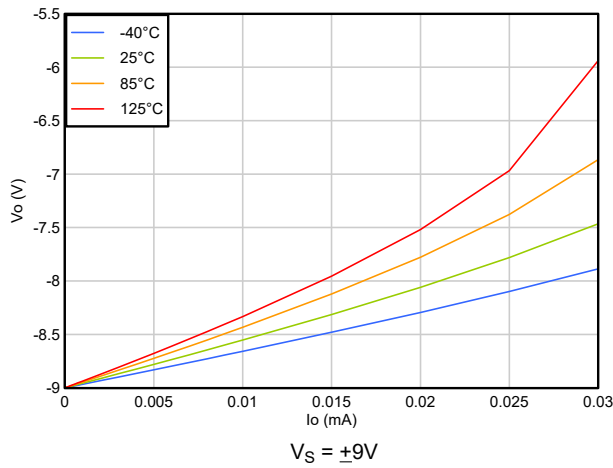

5-25. Output Voltage Swing vs Output Current (Sinking)

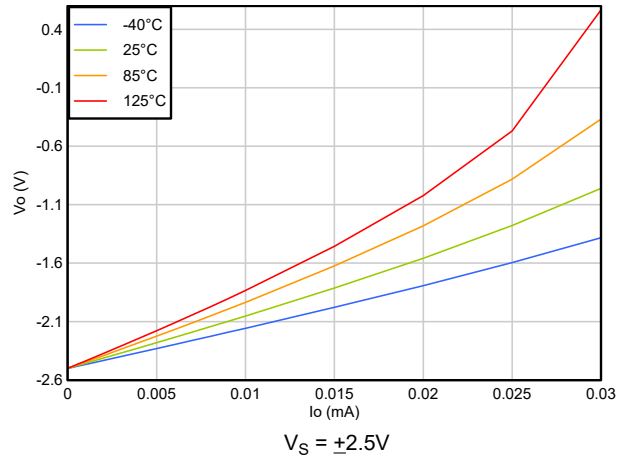

5-26. Output Voltage Swing vs Output Current (Sinking)

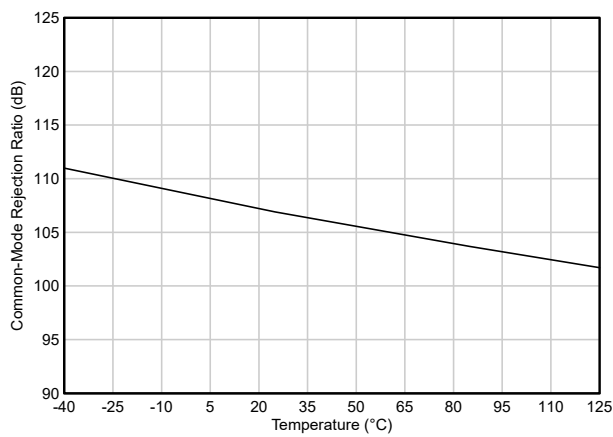

5-27. Common-Mode Rejection Ratio vs Temperature

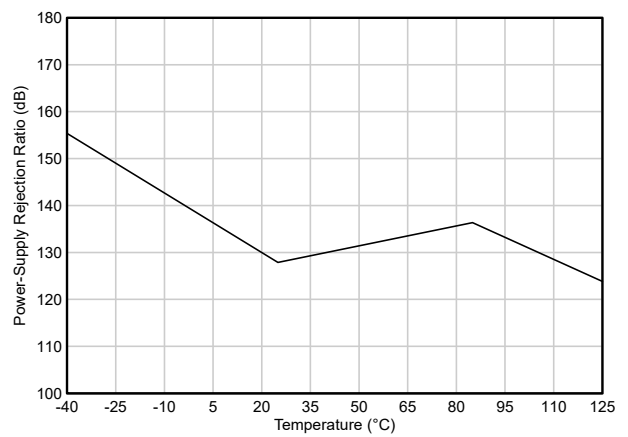

5-28. Power-Supply Rejection Ratio vs Temperature

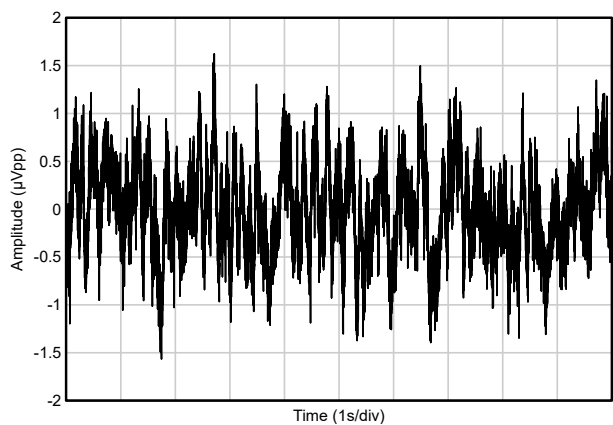

5-29. 0.1Hz to 10Hz Integrated Voltage Noise

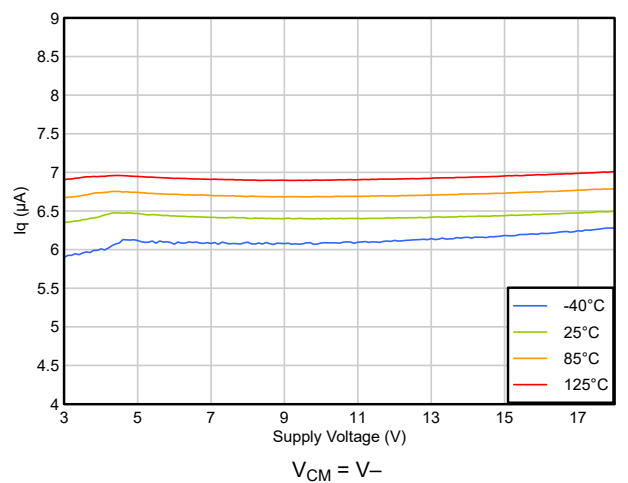

5-30. Quiescent Current vs Supply Voltage

5.8 Typical Characteristics (continued)

at $T_A = 25^\circ\text{C}$, $V_S = \pm 9\text{V}$, $V_{CM} = V_S / 2$, $R_{LOAD} = 10\text{k}\Omega$ (unless otherwise noted)

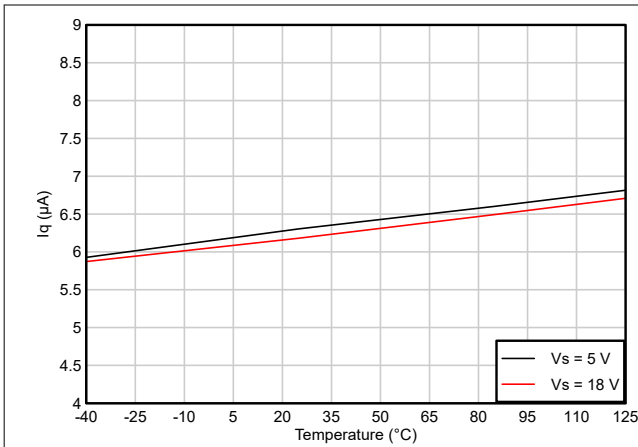

Figure 5-31. Quiescent Current vs Temperature

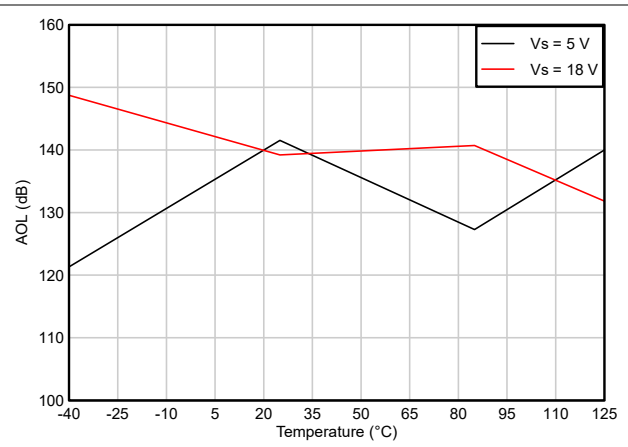

Figure 5-32. Open-Loop Gain vs Temperature

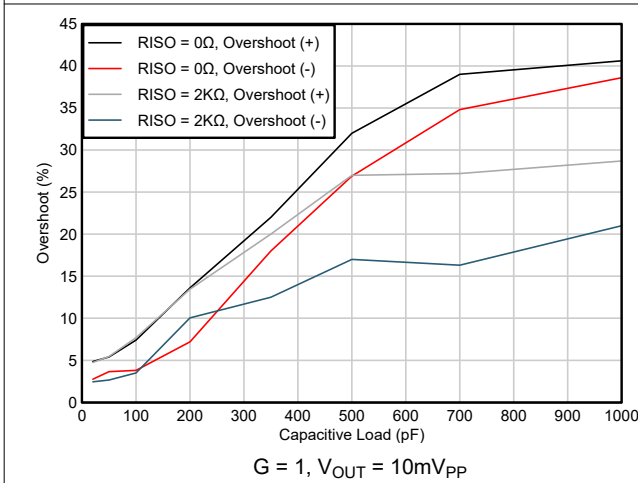

Figure 5-33. Small-Signal Overshoot vs Capacitive Load

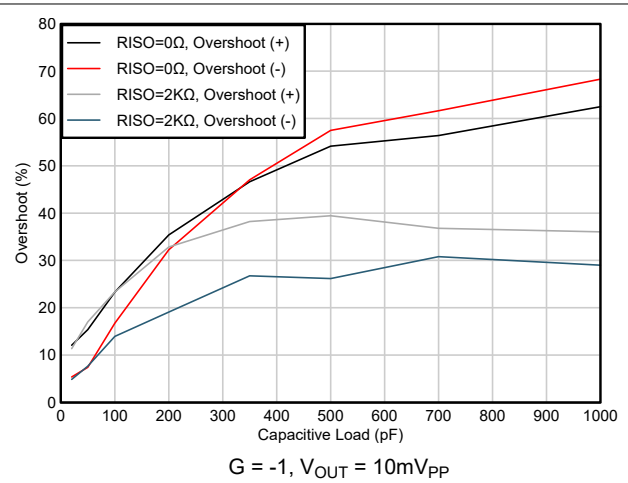

Figure 5-34. Small-Signal Overshoot vs Capacitive Load

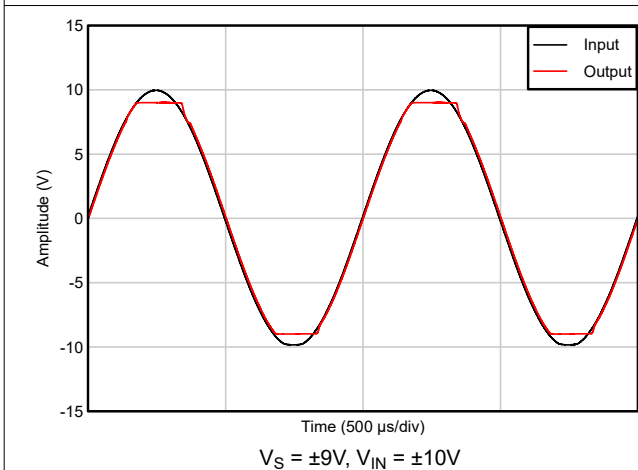

Figure 5-35. No Phase Reversal

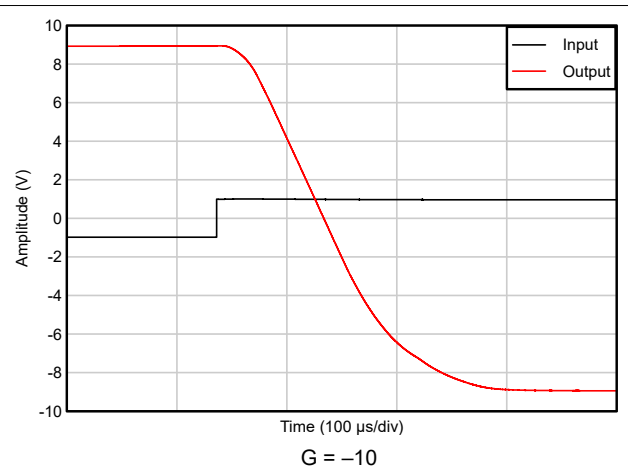

Figure 5-36. Overload Recovery (Positive)

5.8 Typical Characteristics (continued)

at $T_A = 25^\circ\text{C}$, $V_S = \pm 9\text{V}$, $V_{CM} = V_S / 2$, $R_{LOAD} = 10\text{k}\Omega$ (unless otherwise noted)



图 5-37. Overload Recovery (Negative)



图 5-38. Small-Signal Step Response

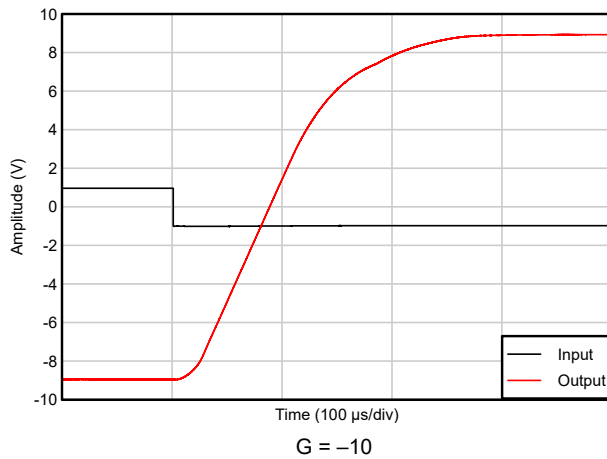

图 5-39. Small-Signal Step Response

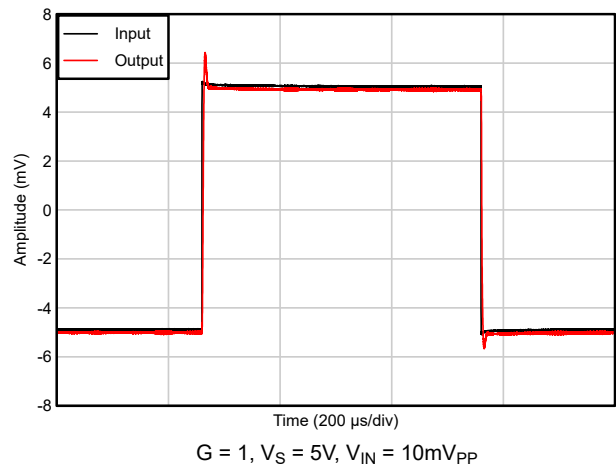

图 5-40. Small-Signal Step Response

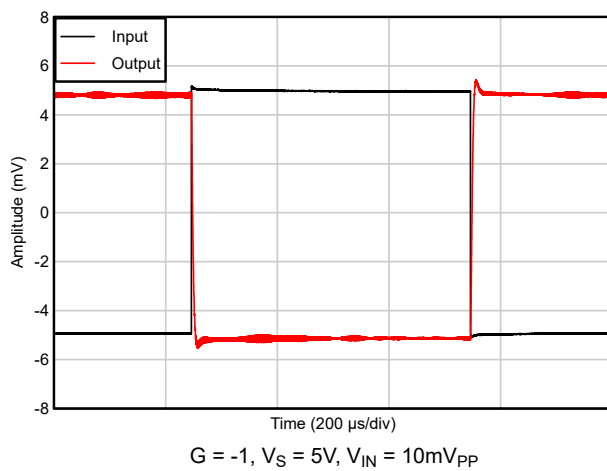

图 5-41. Small-Signal Step Response

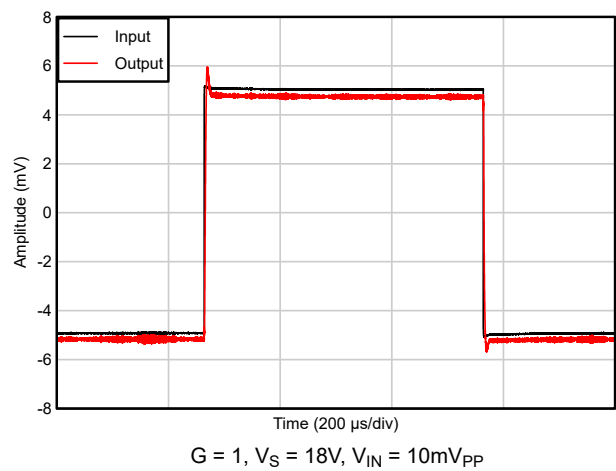

图 5-42. Large-Signal Step Response

5.8 Typical Characteristics (continued)

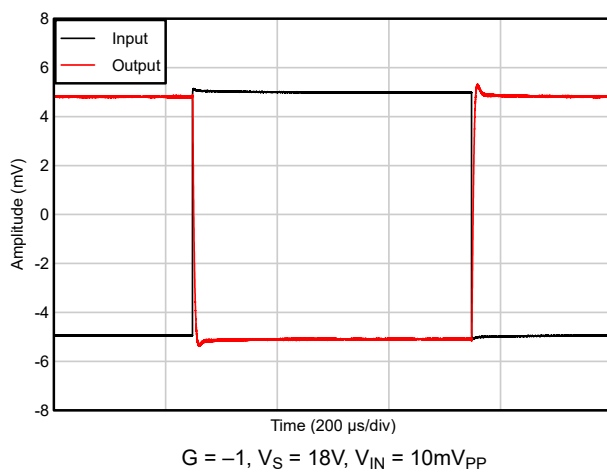
at $T_A = 25^\circ\text{C}$, $V_S = \pm 9\text{V}$, $V_{CM} = V_S / 2$, $R_{LOAD} = 10\text{k}\Omega$ (unless otherwise noted)

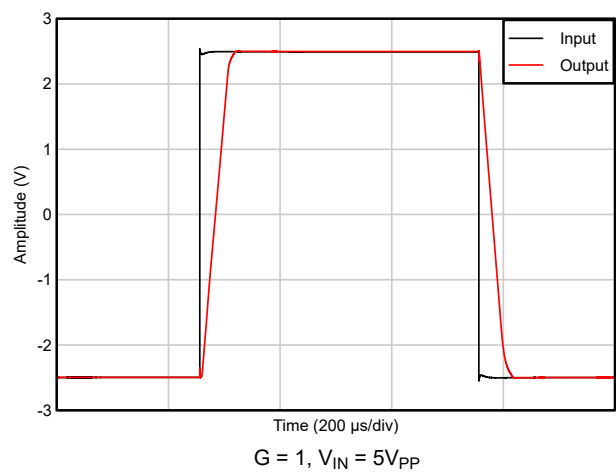
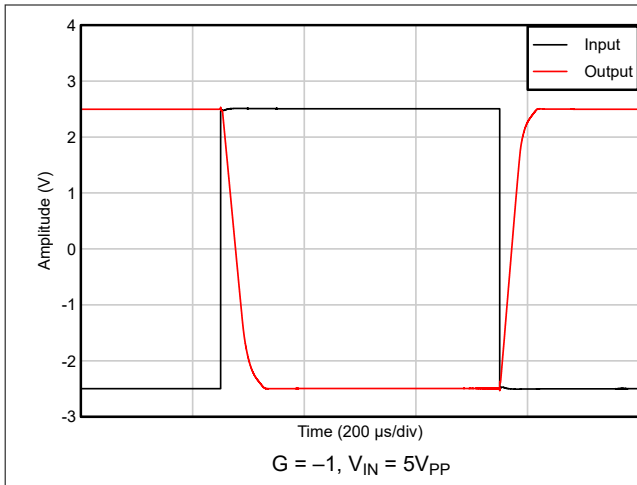

Figure 5-43. Large-Signal Step Response

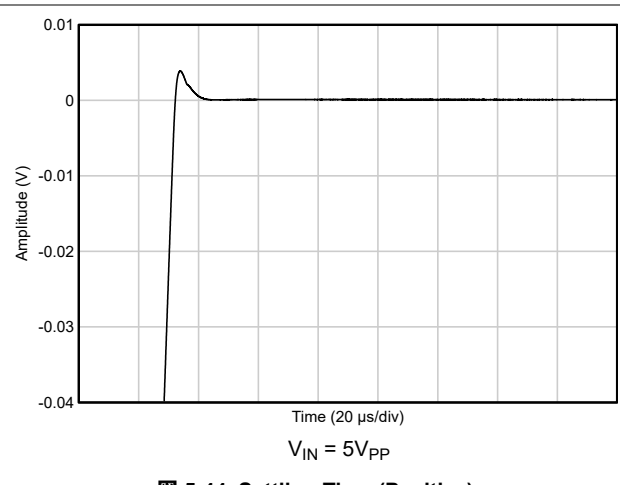

Figure 5-44. Settling Time (Positive)

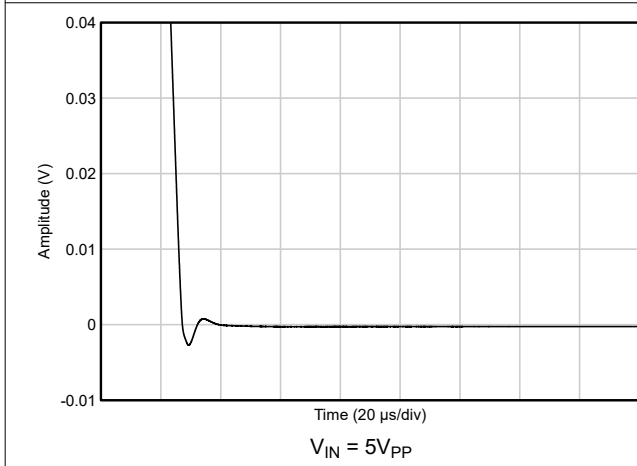

Figure 5-45. Settling Time (Negative)

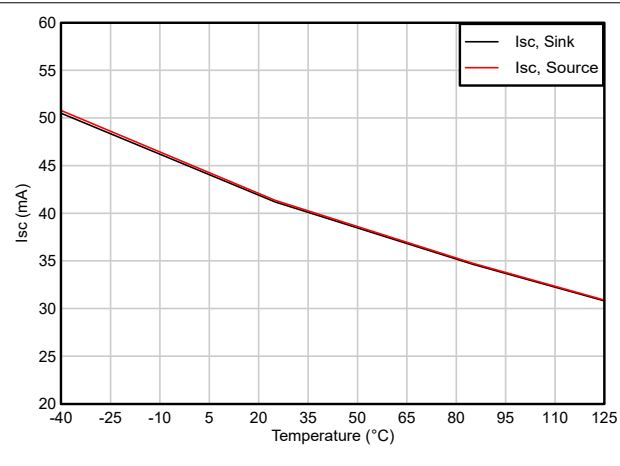

Figure 5-46. Short-Circuit Current vs Temperature

6 Detailed Description

6.1 Overview

The TLV914x family (TLV9141, TLV9142, and TLV9144) is a family of high voltage (18V) general purpose operational amplifiers.

The TLV914x is a low-power family that has a quiescent current of 7 μ A/channel. These devices also offer excellent DC precision, including rail-to-rail input/output, low offset ($\pm 265\mu$ V, typical), and low offset drift ($\pm 0.2\mu$ V/ $^{\circ}$ C, typical). These devices also have a gain bandwidth product of 125kHz and low 1/f flicker noise of 3.4 μ V peak-to-peak (0.1Hz to 10Hz). These strong AC and DC parameters make the TLV914x an extremely flexible, robust, and high-performance operational amplifier for high-voltage industrial applications.

6.2 Functional Block Diagram

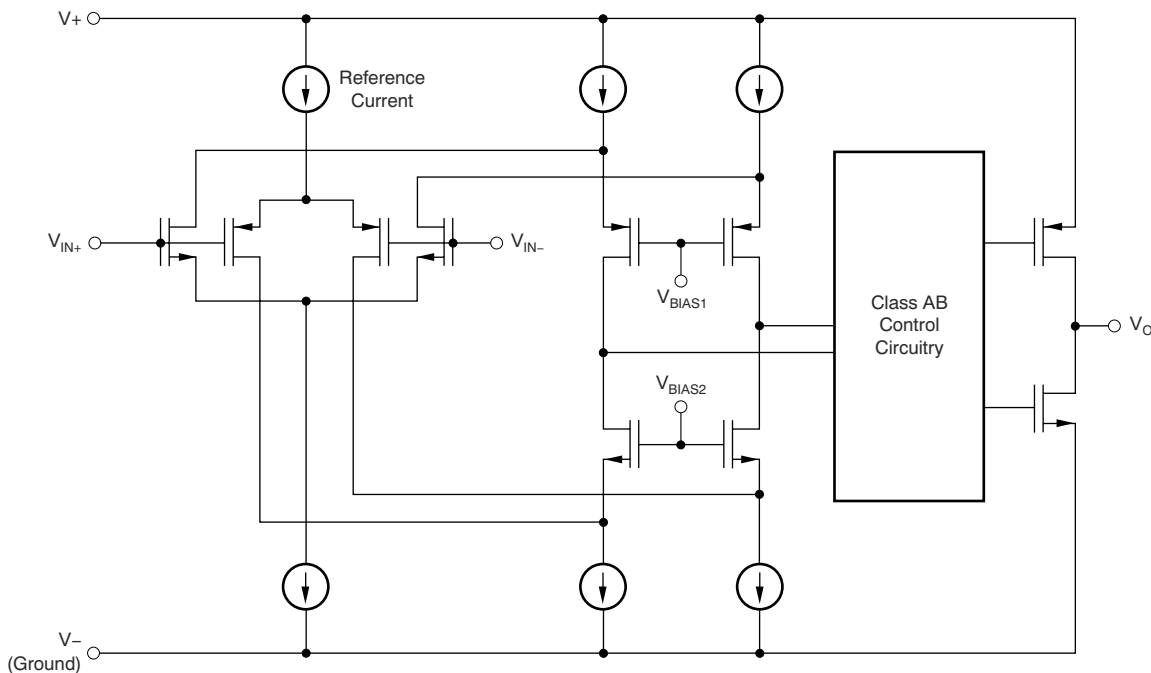

6.3 Feature Description

6.3.1 Input Protection Circuitry

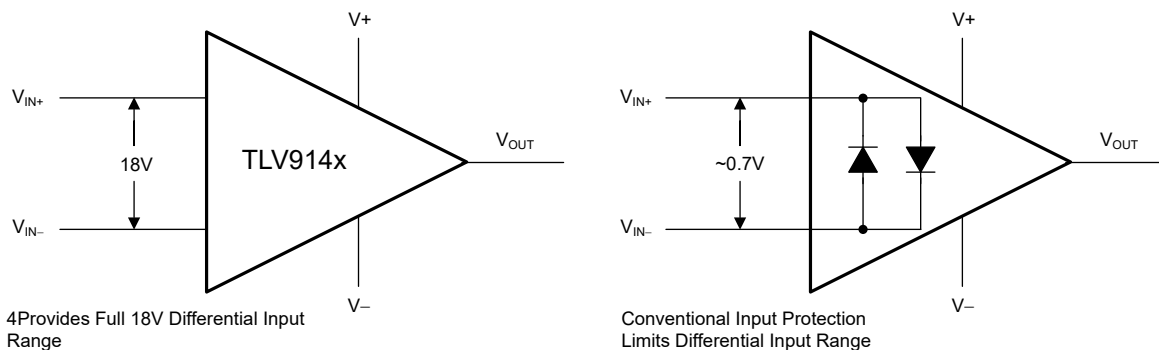
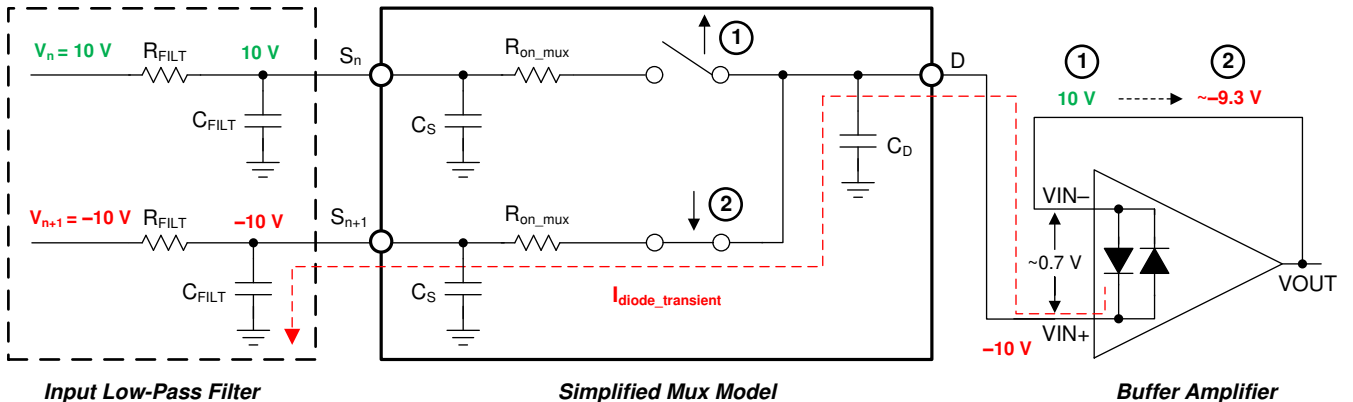
The TLV914x uses a special input architecture to eliminate the requirement for input protection diodes but still provides robust input protection under transient conditions.  6-1 shows conventional input diode protection schemes that are activated by fast transient step responses and introduce signal distortion and settling time delays because of alternate current paths, as shown in  6-2. For low-gain circuits, these fast-ramping input signals forward-bias back-to-back diodes, causing an increase in input current and resulting in extended settling time.

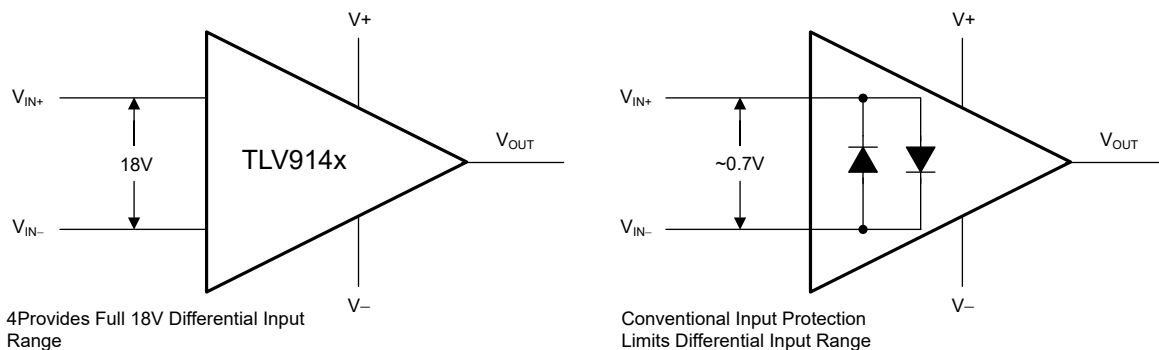

 6-1. TLV914x Input Protection Does Not Limit Differential Input Capability

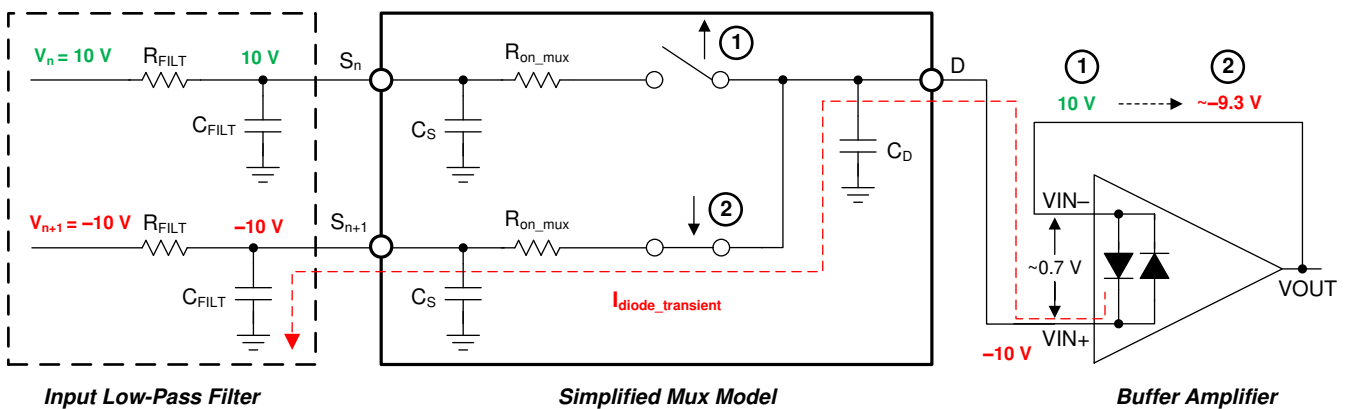

 6-2. Back-to-Back Diodes Create Settling Issues

The TLV914x family of operational amplifiers provides a true high-impedance differential input capability for high-voltage applications using a patented input protection architecture that does not introduce additional signal distortion or delayed settling time, making the device an excellent choice op amp for multichannel, high-switched, input applications. The TLV914x tolerates a maximum differential swing (voltage between inverting and noninverting pins of the op amp) of up to 18V, allowing the device to be used in open-loop configurations. See the [MUX-Friendly Precision Operational Amplifiers application brief](#) for more information.

6.3.2 Common-Mode Voltage Range

The TLV914x is an 18V, true rail-to-rail input operational amplifier with an input common-mode range that extends to both supply rails. This wide range is achieved with paralleled complementary PMOS and NMOS differential input pairs, as shown in [Figure 6-3](#). The NMOS pair is active for input voltages close to the positive rail, typically from $(V+) - 1V$ to the positive supply. The PMOS pair is active for inputs from the negative supply to approximately $(V+) - 2V$. There is a small transition region, multichannel typically $(V+) - 2V$ to $(V+) - 1V$, in which both input pairs are on. This transition region can vary modestly with process variation. Within this region PSRR, CMRR, offset voltage, offset drift, noise, and THD performance can be degraded compared to operation outside this region.

[Figure 5-17](#) shows this transition region for a typical device in terms of input voltage offset in more detail.

For more information on common-mode voltage range and complementary pair interaction, see the [Op amps with complementary-pair input stages: What are the design trade-offs?](#) Analog Design Journal.

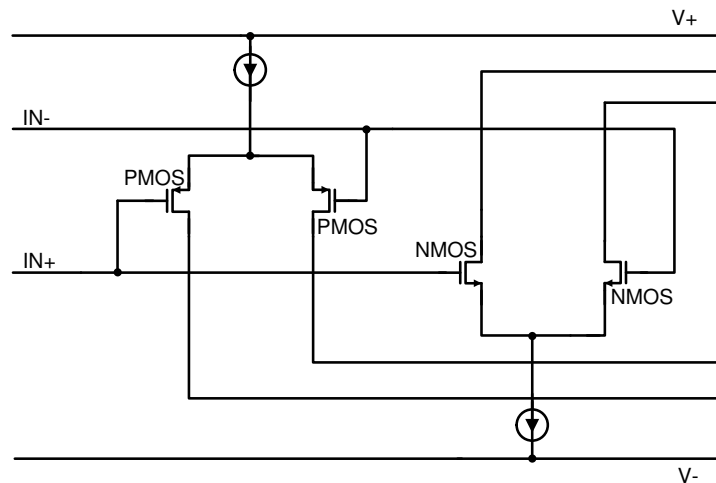

Figure 6-3. Rail-to-Rail Input Stage

6.3.3 EMI Rejection

The TLV914x uses integrated electromagnetic interference (EMI) filtering to reduce the effects of EMI from sources such as wireless communications and densely-populated boards with a mix of analog signal chain and digital components. EMI immunity can be improved with circuit design techniques; the TLV914x benefits from these design improvements. Texas Instruments has developed the ability to accurately measure and quantify the immunity of an operational amplifier over a broad frequency spectrum extending from 10MHz to 6GHz. [Table 6-1](#) provides the EMIRR IN+ values for the TLV914x at particular frequencies commonly encountered in real-world applications. The [EMI Rejection Ratio of Operational Amplifiers](#) application report contains detailed information on the topic of EMIRR performance and how EMIRR relates to op amps and is available for download from www.ti.com.



図 6-4. EMIRR Testing

表 6-1. TLV914x EMIRR IN+ For Frequencies of Interest

FREQUENCY	APPLICATION OR ALLOCATION	EMIRR IN+
400MHz	Mobile radio, mobile satellite, space operation, weather, radar, ultra-high frequency (UHF) applications	50.0dB
900MHz	Global system for mobile communications (GSM) applications, radio communication, navigation, GPS (to 1.6 GHz), GSM, aeronautical mobile, UHF applications	56.3dB
1.8 GHz	GSM applications, mobile personal communications, broadband, satellite, L-band (1 GHz to 2 GHz)	65.6dB
2.4 GHz	802.11b, 802.11g, 802.11n, Bluetooth®, mobile personal communications, industrial, scientific and medical (ISM) radio band, amateur radio and satellite, S-band (2 GHz to 4 GHz)	70.0dB
3.6 GHz	Radiolocation, aero communication and navigation, satellite, mobile, S-band	78.9dB
5 GHz	802.11a, 802.11n, aero communication and navigation, mobile communication, space and satellite operation, C-band (4 GHz to 8 GHz)	91.0dB

6.3.4 Phase Reversal Protection

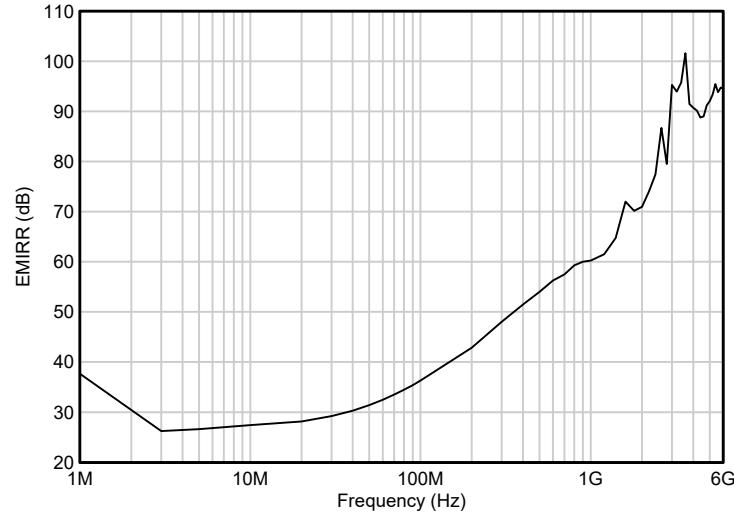
The TLV914x family has internal phase-reversal protection. Many op amps exhibit a phase reversal when the input is driven beyond the linear common-mode range. This condition is most often encountered in noninverting circuits when the input is driven beyond the specified common-mode voltage range, causing the output to reverse into the opposite rail. The TLV914x is a rail-to-rail input op amp; therefore, the common-mode range can extend up to the rails. Input signals beyond the rails do not cause phase reversal; instead, the output limits into the appropriate rail. This performance is shown in 図 6-5. For more information on phase reversal, see [Op amps with complementary-pair input stages: What are the trade-offs?](#) Analog Design Journal.

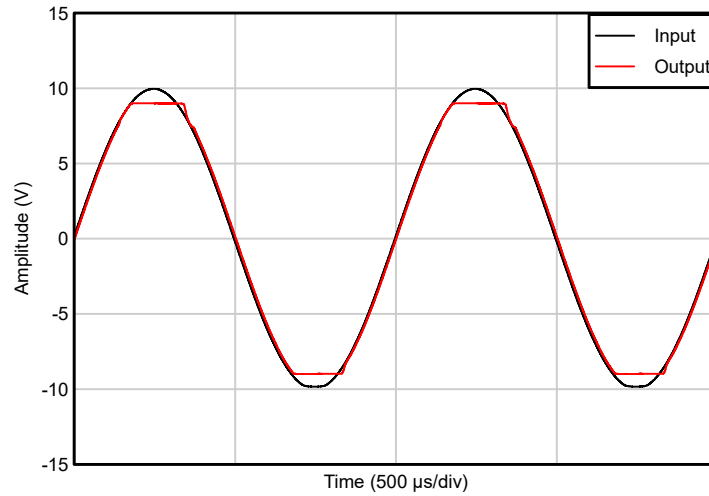

☒ 6-5. No Phase Reversal

6.3.5 Electrical Overstress

Designers often ask questions about the capability of an operational amplifier to withstand electrical overstress (EOS). These questions tend to focus on the device inputs, but can involve the supply voltage pins or even the output pin. Each of these different pin functions have electrical stress limits determined by the voltage breakdown characteristics of the particular semiconductor fabrication process and specific circuits connected to the pin. Additionally, internal electrostatic discharge (ESD) protection is built into these circuits to protect them from accidental ESD events both before and during product assembly.

It is helpful to have a good understanding of this basic ESD circuitry and its relevance to an electrical overstress event.  6-6 shows an illustration of the ESD circuits contained in the TLV914x (indicated by the dashed line area). The ESD protection circuitry involves several current-steering diodes connected from the input and output pins and routed back to the internal power-supply lines, where the diodes meet at an absorption device or the power-supply ESD cell, internal to the operational amplifier. This protection circuitry is intended to remain inactive during normal circuit operation.

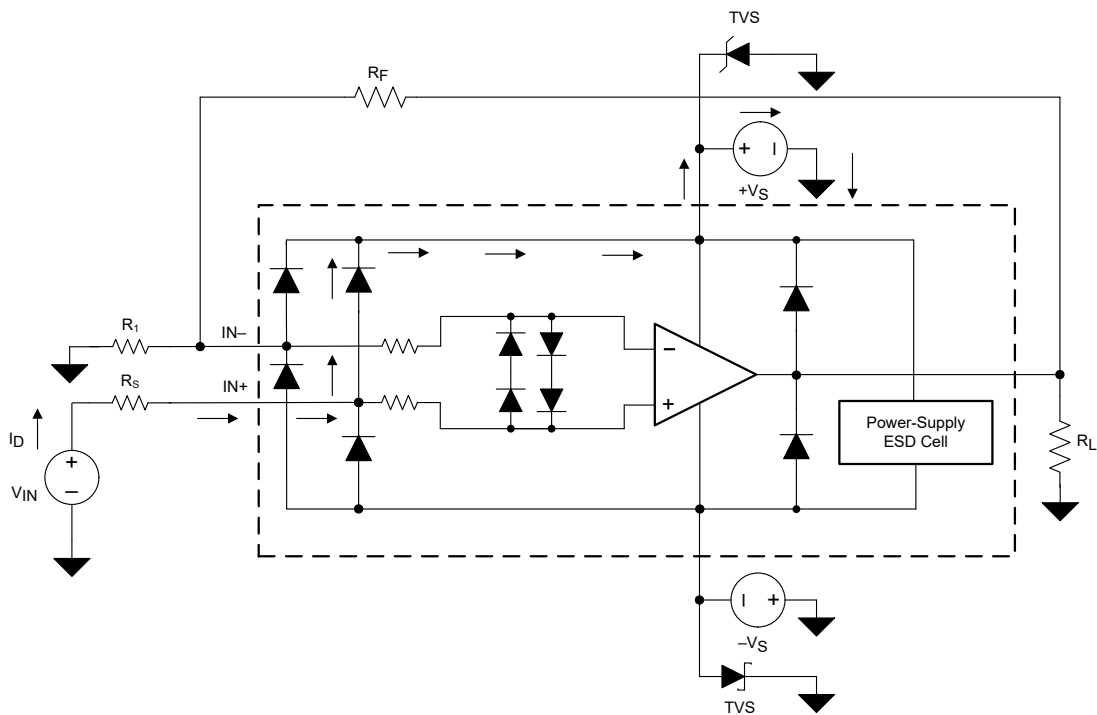

 6-6. Equivalent Internal ESD Circuitry Relative to a Typical Circuit Application

An ESD event produces a short-duration, high-voltage pulse that is transformed into a short-duration, high-current pulse while discharging through a semiconductor device. The ESD protection circuits are designed to provide a current path around the operational amplifier core to prevent damage. The energy absorbed by the protection circuitry is then dissipated as heat.

When an ESD voltage develops across two or more amplifier device terminals, current flows through one or more steering diodes. Depending on the path that the current takes, the absorption device can activate. The absorption device has a trigger, or threshold voltage, that is above the normal operating voltage of the TLV914x but below the device breakdown voltage level. When this threshold is exceeded, the absorption device quickly activates and clamps the voltage across the supply rails to a safe level.

When the operational amplifier connects into a circuit (as shown in [Figure 6-6](#)), the ESD protection components are intended to remain inactive and do not become involved in the application circuit operation. However, circumstances can arise where an applied voltage exceeds the operating voltage range of a given terminal. If this condition occurs, there is a risk that some internal ESD protection circuits can turn on and conduct current. Any such current flow occurs through steering-diode paths and rarely involves the absorption device.

[Figure 6-6](#) shows a specific example where the input voltage (V_{IN}) exceeds the positive supply voltage ($+V_S$) by 500mV or more. Much of what happens in the circuit depends on the supply characteristics. If $+V_S$ can sink the current, one of the upper input steering diodes conducts and directs current to $+V_S$. Excessively high current levels can flow with increasingly higher V_{IN} . As a result, the data sheet specifications recommend that applications limit the input current to 10mA.

If the supply is not capable of sinking the current, V_{IN} can begin sourcing current to the operational amplifier, and then take over as the source of positive supply voltage. The danger in this case is that the voltage can rise to levels that exceed the operational amplifier absolute maximum ratings.

Another common question involves what happens to the amplifier if an input signal is applied to the input while the power supplies $+V_S$ or $-V_S$ are at 0V. Again, this question depends on the supply characteristic while at 0V, or at a level below the input-signal amplitude. If the supplies appear as high impedance, then the input source supplies the operational amplifier current through the current-steering diodes. This state is not a normal bias condition; most likely, the amplifier will not operate normally. If the supplies are low impedance, then the current through the steering diodes can become quite high. The current level depends on the ability of the input source to deliver current, and any resistance in the input path.

If there is any uncertainty about the ability of the supply to absorb this current, add external Zener diodes to the supply terminals; see [Figure 6-6](#). Select the Zener voltage so that the diode does not turn on during normal operation. However, the Zener voltage must be low enough so that the Zener diode conducts if the supply terminal begins to rise above the safe-operating, supply-voltage level.

The TLV914x input terminals are protected from excessive differential voltage with back-to-back diodes; see [Figure 6-6](#). In most circuit applications, the input protection circuitry has no effect. However, in low-gain or $G = 1$ circuits, fast-ramping input signals can forward-bias these diodes because the output of the amplifier cannot respond rapidly enough to the input ramp. If the input signal is fast enough to create this forward-bias condition, limit the input signal current to 10mA or less. If the input signal current is not inherently limited, an input series resistor can be used to limit the input signal current. This input series resistor degrades the low-noise performance of the TLV914x. [Figure 6-6](#) shows an example configuration that implements a current-limiting feedback resistor.

6.3.6 Overload Recovery

Overload recovery is defined as the time required for the op amp output to recover from a saturated state to a linear state. The output devices of the op amp enter a saturation region when the output voltage exceeds the rated operating voltage, either due to the high input voltage or the high gain. After the device enters the saturation region, the charge carriers in the output devices require time to return back to the linear state. After the charge carriers return back to the linear state, the device begins to slew at the specified slew rate. Thus, the

propagation delay in case of an overload condition is the sum of the overload recovery time and the slew time. The overload recovery time for the TLV914x is approximately 400ns.

6.3.7 Typical Specifications and Distributions

Designers often have questions about a typical specification of an amplifier to design a more robust circuit. Due to natural variation in process technology and manufacturing procedures, every specification of an amplifier can exhibit some amount of deviation from the expected value, like the input offset voltage of an amplifier. These deviations often follow *Gaussian (bell curve)*, or *normal* distributions, and circuit designers can leverage this information to guardband a system, even when there is not a minimum or maximum specification in the [Electrical Characteristics](#) table.



図 6-7. Gaussian Distribution

図 6-7 shows an example distribution, where μ , or mu , is the mean of the distribution, and where σ , or *sigma*, is the standard deviation of a system. For a specification that exhibits this kind of distribution, approximately two-thirds (68.26%) of all units can be expected to have a value within one standard deviation, or one sigma, of the mean (from $\mu - \sigma$ to $\mu + \sigma$).

Depending on the specification, values listed in the *typical* column of the [Electrical Characteristics](#) table are represented in different ways. As a general rule, if a specification naturally has a nonzero mean (for example, like gain bandwidth), then the typical value is equal to the mean (μ). However, if a specification naturally has a mean near zero (like input offset voltage), then the typical value is equal to the mean plus one standard deviation ($\mu + \sigma$) to most accurately represent the typical value.

Designers can use this chart to calculate approximate probability of a specification in a unit; for example, for TLV914x, the typical input voltage offset is 265 μ V. So 68.2% of all TLV914x devices are expected to have an offset from -265μ V to $+265\mu$ V. At 4σ ($\pm 800\mu$ V), 99.9937% of the distribution has an offset voltage less than ± 1 mV, which means 0.0063% of the population is outside of these limits, which corresponds to about 1 in 15,873 units.

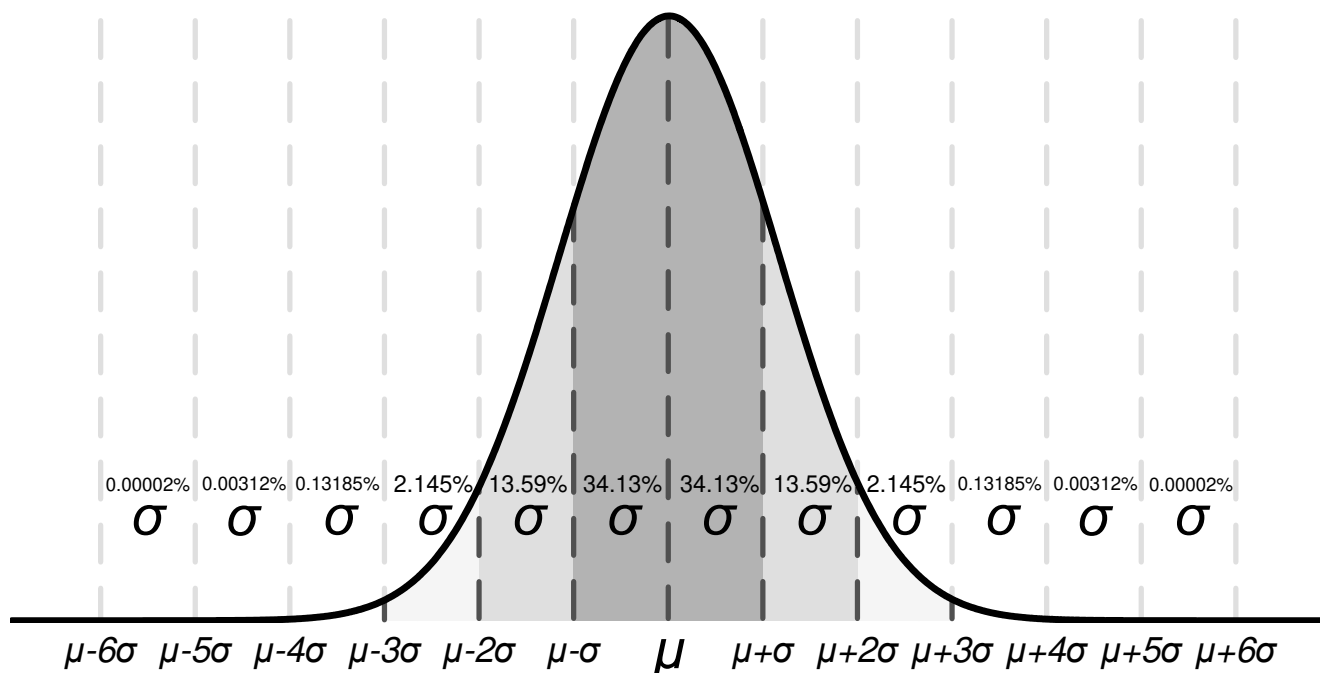
Specifications with a value in the minimum or maximum column are tested by TI, unless otherwise noted, and units outside these limits are removed from production material. For example, the TLV914x family has a maximum offset voltage of 1mV at 25°C, and even though this is extremely unlikely, units with larger offset than 1mV are removed from production material.

For specifications with no value in the minimum or maximum column, consider selecting a sigma value of sufficient guardband for the designers application, and design worst-case conditions using this value. For example, the 6σ value corresponds to about 1 in 500 million units, which is an extremely unlikely chance, and can be an option as a wide guardband to design a system around. In this case, the TLV914x family does not have a maximum or minimum for offset voltage drift. Based on the typical value of $0.2\mu\text{V}/^\circ\text{C}$ in the [Electrical Characteristics](#) table, the expected maximum value for the 6σ value of an offset voltage drift is approximately $1.2\mu\text{V}/^\circ\text{C}$. When designing for worst-case system conditions, this value can be used to estimate the worst possible offset across temperature without having an actual minimum or maximum value.

Note that process variation and adjustments over time can shift typical means and standard deviations, and unless there is a value in the minimum or maximum specification column, TI cannot specify the maximum performance of a device. Only use this information to estimate the performance of a device.

6.4 Device Functional Modes

The TLV914x has a single functional mode and is operational when the power-supply voltage is greater than or equal to 2.7V ($\pm 1.35\text{V}$). The maximum power supply voltage for the TLV914x is 18V ($\pm 9\text{V}$).

7 Application and Implementation

注

Information in the following applications sections is not part of the TI component specification, and TI does not warrant its accuracy or completeness. TI's customers are responsible for determining suitability of components for their purposes, as well as validating and testing their design implementation to confirm system functionality.

7.1 Application Information

The TLV914x family offers excellent DC precision and AC performance. These devices operate up to 18V supply rails and offer true rail-to-rail input and output, low offset voltage and offset voltage drift, as well as 125kHz bandwidth and high output drive. These features make the TLV914x a robust, high-performance operational amplifier for high-voltage industrial applications.

7.2 Typical Applications

7.2.1 Low-Side Current Measurement

Figure 7-1 shows the TLV9141 configured in a low-side current sensing application. For a full analysis of the circuit shown in Figure 7-1 including theory, calculations, simulations, and measured data, see TI Precision Design TIPD129, [0A to 1A Single-Supply Low-Side Current-Sensing Solution](#).

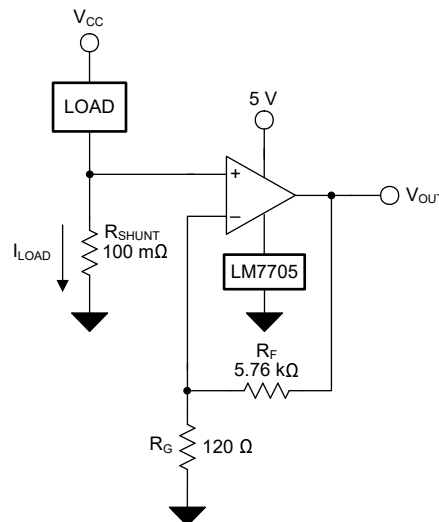

Figure 7-1. TLV914x in a Low-Side, Current-Sensing Application

7.2.1.1 Design Requirements

The design requirements for this design are as follows:

- Load current: 0A to 1A
- Max output voltage: 4.9V
- Maximum shunt voltage: 100mV

7.2.1.2 Detailed Design Procedure

The transfer function of the circuit in Figure 7-1 is given in Equation 1:

$$V_{OUT} = I_{LOAD} \times R_{SHUNT} \times \text{Gain} \quad (1)$$

The load current (I_{LOAD}) produces a voltage drop across the shunt resistor (R_{SHUNT}). The load current is set from 0A to 1A. To keep the shunt voltage below 100mV at maximum load current, the largest shunt resistor is defined using 式 2:

$$R_{SHUNT} = \frac{V_{SHUNT_MAX}}{I_{LOAD_MAX}} = \frac{100mV}{1A} = 100m\Omega \quad (2)$$

Using 式 2, R_{SHUNT} is calculated to be 100m Ω . The voltage drop produced by I_{LOAD} and R_{SHUNT} is amplified by the TLV9141 to produce an output voltage of 0V to 4.9V. The gain needed by the TLV9141 to produce the necessary output voltage is calculated using 式 3:

$$\text{Gain} = \frac{(V_{OUT_MAX} - V_{OUT_MIN})}{(V_{IN_MAX} - V_{IN_MIN})} \quad (3)$$

Using 式 3, the required gain is calculated to be 49V/V, which is set with resistors R_F and R_G . 式 4 is used to size the resistors, R_F and R_G , to set the gain of the TLV9141 to 49V/V.

$$\text{Gain} = 1 + \frac{(R_F)}{(R_G)} \quad (4)$$

Choosing R_F as 5.76k Ω , R_G is calculated to be 120 Ω . R_F and R_G were chosen as 5.76k Ω and 120 Ω because those are standard value resistors that create a 49:1 ratio. Other resistors that create a 49:1 ratio can also be used. However, excessively large resistors can generate thermal noise that exceeds the intrinsic noise of the op amp. 図 7-2 shows the measured transfer function of the circuit shown in 図 7-1.

7.2.1.3 Application Curve



図 7-2. Low-Side, Current-Sense, Transfer Function

7.3 Power Supply Recommendations

The TLV914x is specified for operation from 2.7V to 18V ($\pm 1.35V$ to $\pm 9V$); many specifications apply from $-40^{\circ}C$ to $125^{\circ}C$ or with specific supply voltages and test conditions.

注意

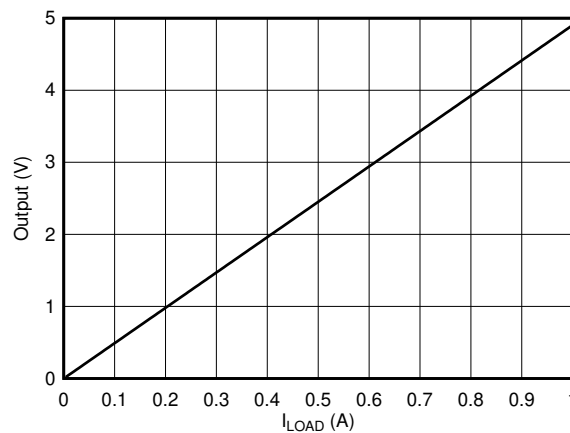
Supply voltages larger than 20V can permanently damage the device; see [Absolute Maximum Ratings](#).

Place 0.1 μF bypass capacitors close to the power-supply pins to reduce errors coupling in from noisy or high-impedance power supplies. For more detailed information on bypass capacitor placement, refer to [Layout](#).

7.4 Layout

7.4.1 Layout Guidelines

For best operational performance of the device, use good PCB layout practices, including:

- Noise can propagate into analog circuitry through the power pins of the circuit as a whole and into the op amp. Bypass capacitors are used to reduce the coupled noise by providing low-impedance power sources local to the analog circuitry.
 - Connect low-ESR, 0.1 μ F ceramic bypass capacitors between each supply pin and ground, placed as close to the device as possible. A single bypass capacitor from V+ to ground is applicable for single-supply applications.
- Separate grounding for analog and digital portions of circuitry is one of the simplest and most-effective methods of noise suppression. One or more layers on multilayer PCBs are usually devoted to ground planes. A ground plane helps distribute heat and reduces EMI noise pickup. Make sure to physically separate digital and analog grounds paying attention to the flow of the ground current.
- To reduce parasitic coupling, run the input traces as far away from the supply or output traces as possible. If these traces cannot be kept separate, crossing the sensitive trace perpendicular is much better as opposed to in parallel with the noisy trace.
- Place the external components as close to the device as possible. As shown in [Figure 7-4](#), keeping RF and RG close to the inverting input minimizes parasitic capacitance.
- Keep the length of input traces as short as possible. Always remember that the input traces are the most sensitive part of the circuit.
- Consider a driven, low-impedance guard ring around the critical traces. A guard ring can significantly reduce leakage currents from nearby traces that are at different potentials.
- Cleaning the PCB following board assembly is recommended for best performance.
- Any precision integrated circuit can experience performance shifts due to moisture ingress into the plastic package. Following any aqueous PCB cleaning process, baking the PCB assembly is recommended to remove moisture introduced into the device packaging during the cleaning process. A low temperature, post cleaning bake at 85°C for 30 minutes is sufficient for most circumstances.

7.4.2 Layout Example

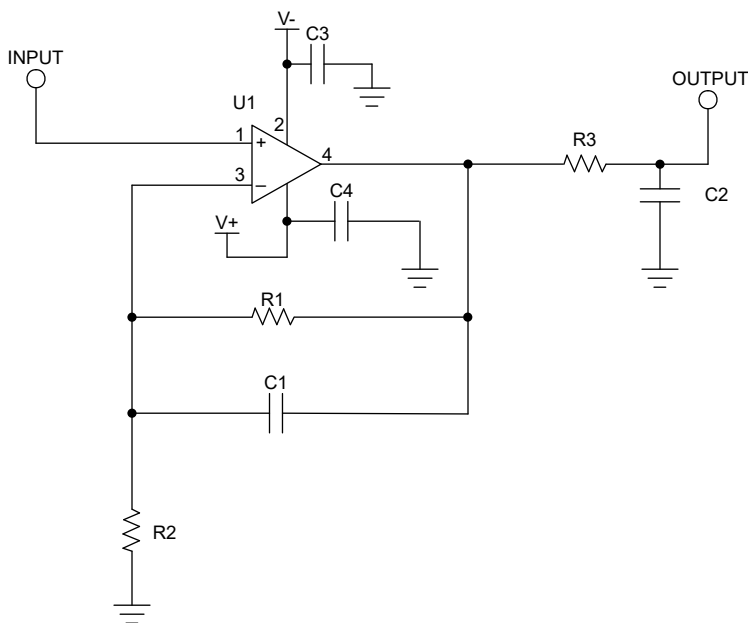

Figure 7-3. Schematic for Noninverting Configuration Layout Example



図 7-4. Example Layout for TLV9142

8 Device and Documentation Support

8.1 Device Support

8.1.1 Development Support

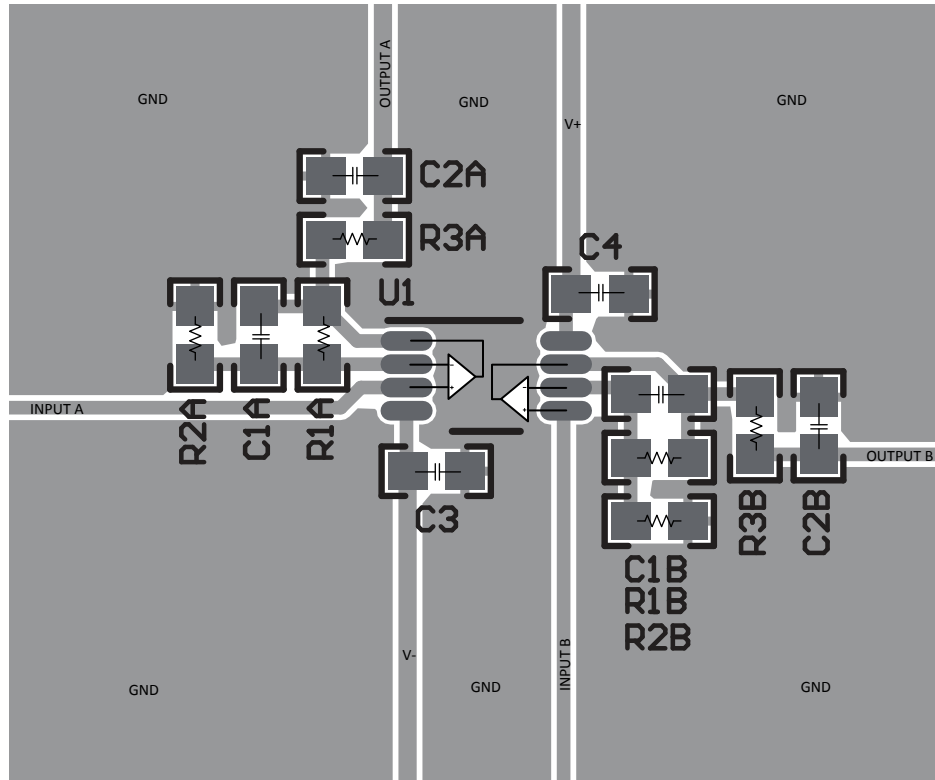
8.1.1.1 TINA-TI™ (Free Software Download)

TINA™ is a simple, powerful, and easy-to-use circuit simulation program based on a SPICE engine. TINA-TI is a free, fully-functional version of the TINA software, preloaded with a library of macro models in addition to a range of both passive and active models. TINA-TI provides all the conventional dc, transient, and frequency domain analysis of SPICE, as well as additional design capabilities.

Available as a [free download](#) from the Analog eLab Design Center, TINA-TI offers extensive post-processing capability that allows users to format results in a variety of ways. Virtual instruments offer the ability to select input waveforms and probe circuit nodes, voltages, and waveforms, creating a dynamic quick-start tool.

注

These files require that either the TINA software (from DesignSoft™) or TINA-TI software be installed. Download the free TINA-TI software from the [TINA-TI folder](#).

8.2 Documentation Support

8.2.1 Related Documentation

For related documentation, see the following:

- Texas Instruments, [MUX-Friendly, Precision Operational Amplifiers application brief](#)
- Texas Instruments, [EMI Rejection Ratio of Operational Amplifiers application note](#)
- Texas Instruments, [Op amps with complementary-pair input stages: What are the trade-offs? Analog Design Journal](#)
- Texas Instruments, [0A to 1A, Single-Supply, Low-Side, Current Sensing Solution design guide](#)

8.3 ドキュメントの更新通知を受け取る方法

ドキュメントの更新についての通知を受け取るには、www.tij.co.jp のデバイス製品フォルダを開いてください。[通知] をクリックして登録すると、変更されたすべての製品情報に関するダイジェストを毎週受け取ることができます。変更の詳細については、改訂されたドキュメントに含まれている改訂履歴をご覧ください。

8.4 サポート・リソース

[テキサス・インスツルメンツ E2E™ サポート・フォーラム](#)は、エンジニアが検証済みの回答と設計に関するヒントをエキスパートから迅速かつ直接得ることができる場所です。既存の回答を検索したり、独自の質問をしたりすることで、設計に必要な支援を迅速に得ることができます。

リンクされているコンテンツは、各寄稿者により「現状のまま」提供されるものです。これらはテキサス・インスツルメンツの仕様を構成するものではなく、必ずしもテキサス・インスツルメンツの見解を反映したものではありません。テキサス・インスツルメンツの[使用条件](#)を参照してください。

8.5 Trademarks

TINA-TI™ and テキサス・インスツルメンツ E2E™ are trademarks of Texas Instruments.

TINA™ and DesignSoft™ are trademarks of DesignSoft, Inc.

Bluetooth® is a registered trademark of Bluetooth SIG, Inc.

すべての商標は、それぞれの所有者に帰属します。

8.6 静電気放電に関する注意事項



この IC は、ESD によって破損する可能性があります。テキサス・インスツルメンツは、IC を取り扱う際には常に適切な注意を払うことを推奨します。正しい取り扱いおよび設置手順に従わない場合、デバイスを破損するおそれがあります。

ESD による破損は、わずかな性能低下からデバイスの完全な故障まで多岐にわたります。精密な IC の場合、パラメータがわずかに変化するだけで公表されている仕様から外れる可能性があるため、破損が発生しやすくなっています。

8.7 用語集

[テキサス・インスツルメンツ用語集](#) この用語集には、用語や略語の一覧および定義が記載されています。

9 Revision History

資料番号末尾の英字は改訂を表しています。その改訂履歴は英語版に準じています。

DATE	REVISION	NOTES
December 2024	*	Initial Release

10 Mechanical, Packaging, and Orderable Information

The following pages include mechanical, packaging, and orderable information. This information is the most current data available for the designated devices. This data is subject to change without notice and revision of this document. For browser-based versions of this data sheet, refer to the left-hand navigation.

PACKAGING INFORMATION

Orderable Device	Status (1)	Package Type	Package Drawing	Pins	Package Qty	Eco Plan (2)	Lead finish/ Ball material (6)	MSL Peak Temp (3)	Op Temp (°C)	Device Marking (4/5)	Samples
TLV91411DBVR	ACTIVE	SOT-23	DBV	5	3000	RoHS & Green	SN	Level-1-260C-UNLIM	-40 to 125	94DBV	Samples
TLV91411DR	ACTIVE	SOIC	D	8	3000	RoHS & Green	NIPDAU	Level-1-260C-UNLIM	-40 to 125	91411D	Samples
TLV91421DR	ACTIVE	SOIC	D	8	3000	RoHS & Green	NIPDAU	Level-1-260C-UNLIM	-40 to 125	91421D	Samples
TLV91441DR	ACTIVE	SOIC	D	14	3000	RoHS & Green	NIPDAU	Level-1-260C-UNLIM	-40 to 125	TLV91441DR	Samples
TLV91441IN	ACTIVE	PDIP	N	14	25	RoHS & Green	NIPDAU	N / A for Pkg Type	-40 to 125	91441IN	Samples
TLV91441PWR	ACTIVE	TSSOP	PW	14	3000	RoHS & Green	NIPDAU	Level-1-260C-UNLIM	-40 to 125	9144PW	Samples

(1) The marketing status values are defined as follows:

ACTIVE: Product device recommended for new designs.

LIFEBUY: TI has announced that the device will be discontinued, and a lifetime-buy period is in effect.

NRND: Not recommended for new designs. Device is in production to support existing customers, but TI does not recommend using this part in a new design.

PREVIEW: Device has been announced but is not in production. Samples may or may not be available.

OBSELETE: TI has discontinued the production of the device.

(2) **RoHS:** TI defines "RoHS" to mean semiconductor products that are compliant with the current EU RoHS requirements for all 10 RoHS substances, including the requirement that RoHS substance do not exceed 0.1% by weight in homogeneous materials. Where designed to be soldered at high temperatures, "RoHS" products are suitable for use in specified lead-free processes. TI may reference these types of products as "Pb-Free".

RoHS Exempt: TI defines "RoHS Exempt" to mean products that contain lead but are compliant with EU RoHS pursuant to a specific EU RoHS exemption.

Green: TI defines "Green" to mean the content of Chlorine (Cl) and Bromine (Br) based flame retardants meet JS709B low halogen requirements of <=1000ppm threshold. Antimony trioxide based flame retardants must also meet the <=1000ppm threshold requirement.

(3) MSL, Peak Temp. - The Moisture Sensitivity Level rating according to the JEDEC industry standard classifications, and peak solder temperature.

(4) There may be additional marking, which relates to the logo, the lot trace code information, or the environmental category on the device.

(5) Multiple Device Markings will be inside parentheses. Only one Device Marking contained in parentheses and separated by a "-" will appear on a device. If a line is indented then it is a continuation of the previous line and the two combined represent the entire Device Marking for that device.

(6) Lead finish/Ball material - Orderable Devices may have multiple material finish options. Finish options are separated by a vertical ruled line. Lead finish/Ball material values may wrap to two lines if the finish value exceeds the maximum column width.

Important Information and Disclaimer: The information provided on this page represents TI's knowledge and belief as of the date that it is provided. TI bases its knowledge and belief on information provided by third parties, and makes no representation or warranty as to the accuracy of such information. Efforts are underway to better integrate information from third parties. TI has taken and continues to take reasonable steps to provide representative and accurate information but may not have conducted destructive testing or chemical analysis on incoming materials and chemicals. TI and TI suppliers consider certain information to be proprietary, and thus CAS numbers and other limited information may not be available for release.

In no event shall TI's liability arising out of such information exceed the total purchase price of the TI part(s) at issue in this document sold by TI to Customer on an annual basis.

DBV0005A



PACKAGE OUTLINE

SOT-23 - 1.45 mm max height

SMALL OUTLINE TRANSISTOR



4214839/K 08/2024

NOTES:

1. All linear dimensions are in millimeters. Any dimensions in parenthesis are for reference only. Dimensioning and tolerancing per ASME Y14.5M.
2. This drawing is subject to change without notice.
3. Reference JEDEC MO-178.
4. Body dimensions do not include mold flash, protrusions, or gate burrs. Mold flash, protrusions, or gate burrs shall not exceed 0.25 mm per side.
5. Support pin may differ or may not be present.

EXAMPLE BOARD LAYOUT

DBV0005A

SOT-23 - 1.45 mm max height

SMALL OUTLINE TRANSISTOR



LAND PATTERN EXAMPLE
EXPOSED METAL SHOWN
SCALE:15X



SOLDER MASK DETAILS

4214839/K 08/2024

NOTES: (continued)

- 6. Publication IPC-7351 may have alternate designs.
- 7. Solder mask tolerances between and around signal pads can vary based on board fabrication site.

EXAMPLE STENCIL DESIGN

DBV0005A

SOT-23 - 1.45 mm max height

SMALL OUTLINE TRANSISTOR



SOLDER PASTE EXAMPLE
BASED ON 0.125 mm THICK STENCIL
SCALE:15X

4214839/K 08/2024

NOTES: (continued)

8. Laser cutting apertures with trapezoidal walls and rounded corners may offer better paste release. IPC-7525 may have alternate design recommendations.
9. Board assembly site may have different recommendations for stencil design.



D0014A

PACKAGE OUTLINE

SOIC - 1.75 mm max height

SMALL OUTLINE INTEGRATED CIRCUIT



4220718/A 09/2016

NOTES:

1. All linear dimensions are in millimeters. Dimensions in parenthesis are for reference only. Dimensioning and tolerancing per ASME Y14.5M.
2. This drawing is subject to change without notice.
3. This dimension does not include mold flash, protrusions, or gate burrs. Mold flash, protrusions, or gate burrs shall not exceed 0.15 mm, per side.
4. This dimension does not include interlead flash. Interlead flash shall not exceed 0.43 mm, per side.
5. Reference JEDEC registration MS-012, variation AB.

EXAMPLE BOARD LAYOUT

D0014A

SOIC - 1.75 mm max height

SMALL OUTLINE INTEGRATED CIRCUIT



LAND PATTERN EXAMPLE
SCALE:8X



SOLDER MASK DETAILS

4220718/A 09/2016

NOTES: (continued)

- 6. Publication IPC-7351 may have alternate designs.
- 7. Solder mask tolerances between and around signal pads can vary based on board fabrication site.

EXAMPLE STENCIL DESIGN

D0014A

SOIC - 1.75 mm max height

SMALL OUTLINE INTEGRATED CIRCUIT



SOLDER PASTE EXAMPLE
BASED ON 0.125 mm THICK STENCIL
SCALE:8X

4220718/A 09/2016

NOTES: (continued)

8. Laser cutting apertures with trapezoidal walls and rounded corners may offer better paste release. IPC-7525 may have alternate design recommendations.
9. Board assembly site may have different recommendations for stencil design.



D0008A

PACKAGE OUTLINE

SOIC - 1.75 mm max height

SMALL OUTLINE INTEGRATED CIRCUIT



4214825/C 02/2019

NOTES:

1. Linear dimensions are in inches [millimeters]. Dimensions in parenthesis are for reference only. Controlling dimensions are in inches. Dimensioning and tolerancing per ASME Y14.5M.
2. This drawing is subject to change without notice.
3. This dimension does not include mold flash, protrusions, or gate burrs. Mold flash, protrusions, or gate burrs shall not exceed $.006$ [0.15] per side.
4. This dimension does not include interlead flash.
5. Reference JEDEC registration MS-012, variation AA.

EXAMPLE BOARD LAYOUT

D0008A

SOIC - 1.75 mm max height

SMALL OUTLINE INTEGRATED CIRCUIT



LAND PATTERN EXAMPLE
EXPOSED METAL SHOWN
SCALE:8X



SOLDER MASK DETAILS

4214825/C 02/2019

NOTES: (continued)

- 6. Publication IPC-7351 may have alternate designs.
- 7. Solder mask tolerances between and around signal pads can vary based on board fabrication site.

EXAMPLE STENCIL DESIGN

D0008A

SOIC - 1.75 mm max height

SMALL OUTLINE INTEGRATED CIRCUIT



SOLDER PASTE EXAMPLE
BASED ON .005 INCH [0.125 MM] THICK STENCIL
SCALE:8X

4214825/C 02/2019

NOTES: (continued)

8. Laser cutting apertures with trapezoidal walls and rounded corners may offer better paste release. IPC-7525 may have alternate design recommendations.
9. Board assembly site may have different recommendations for stencil design.

N (R-PDIP-T**)

PLASTIC DUAL-IN-LINE PACKAGE

16 PINS SHOWN



- NOTES:
- A. All linear dimensions are in inches (millimeters).
 - B. This drawing is subject to change without notice.
 - Falls within JEDEC MS-001, except 18 and 20 pin minimum body length (Dim A).
 - The 20 pin end lead shoulder width is a vendor option, either half or full width.

PW0014A



PACKAGE OUTLINE
TSSOP - 1.2 mm max height

SMALL OUTLINE PACKAGE



4220202/B 12/2023

NOTES:

1. All linear dimensions are in millimeters. Any dimensions in parenthesis are for reference only. Dimensioning and tolerancing per ASME Y14.5M.
2. This drawing is subject to change without notice.
3. This dimension does not include mold flash, protrusions, or gate burrs. Mold flash, protrusions, or gate burrs shall not exceed 0.15 mm per side.
4. This dimension does not include interlead flash. Interlead flash shall not exceed 0.25 mm per side.
5. Reference JEDEC registration MO-153.

EXAMPLE BOARD LAYOUT

PW0014A

TSSOP - 1.2 mm max height

SMALL OUTLINE PACKAGE



LAND PATTERN EXAMPLE
EXPOSED METAL SHOWN
SCALE: 10X



4220202/B 12/2023

NOTES: (continued)

- 6. Publication IPC-7351 may have alternate designs.
- 7. Solder mask tolerances between and around signal pads can vary based on board fabrication site.

EXAMPLE STENCIL DESIGN

PW0014A

TSSOP - 1.2 mm max height

SMALL OUTLINE PACKAGE



SOLDER PASTE EXAMPLE
BASED ON 0.125 mm THICK STENCIL
SCALE: 10X

4220202/B 12/2023

NOTES: (continued)

- 8. Laser cutting apertures with trapezoidal walls and rounded corners may offer better paste release. IPC-7525 may have alternate design recommendations.
- 9. Board assembly site may have different recommendations for stencil design.

重要なお知らせと免責事項

テキサス・インスツルメンツは、技術データと信頼性データ(データシートを含みます)、設計リソース(リファレンス デザインを含みます)、アプリケーションや設計に関する各種アドバイス、Web ツール、安全性情報、その他のリソースを、欠陥が存在する可能性のある「現状のまま」提供しており、商品性および特定目的に対する適合性の黙示保証、第三者の知的財産権の非侵害保証を含むいかなる保証も、明示的または黙示的にかかわらず拒否します。

これらのリソースは、テキサス・インスツルメンツ製品を使用する設計の経験を積んだ開発者への提供を意図したものです。(1) お客様のアプリケーションに適したテキサス・インスツルメンツ製品の選定、(2) お客様のアプリケーションの設計、検証、試験、(3) お客様のアプリケーションに該当する各種規格や、その他のあらゆる安全性、セキュリティ、規制、または他の要件への確実な適合に関する責任を、お客様のみが単独で負うものとし、ます。

上記の各種リソースは、予告なく変更される可能性があります。これらのリソースは、リソースで説明されているテキサス・インスツルメンツ製品を使用するアプリケーションの開発の目的でのみ、テキサス・インスツルメンツはその使用をお客様に許諾します。これらのリソースに関して、他の目的で複製することや掲載することは禁止されています。テキサス・インスツルメンツや第三者の知的財産権のライセンスが付与されている訳ではありません。お客様は、これらのリソースを自身で使用した結果発生するあらゆる申し立て、損害、費用、損失、責任について、テキサス・インスツルメンツおよびその代理人を完全に補償するものとし、テキサス・インスツルメンツは一切の責任を拒否します。

テキサス・インスツルメンツの製品は、[テキサス・インスツルメンツの販売条件](#)、または [ti.com](https://www.ti.com) やかかるテキサス・インスツルメンツ製品の関連資料などのいずれかを通じて提供する適用可能な条項の下で提供されています。テキサス・インスツルメンツがこれらのリソースを提供することは、適用されるテキサス・インスツルメンツの保証または他の保証の放棄の拡大や変更を意味するものではありません。

お客様がいかなる追加条項または代替条項を提案した場合でも、テキサス・インスツルメンツはそれらに異議を唱え、拒否します。

郵送先住所：Texas Instruments, Post Office Box 655303, Dallas, Texas 75265
Copyright © 2025, Texas Instruments Incorporated