

# TLV701x および TLV702x 小型、低消費電力、低電圧コンパレータ

## 1 特長

- 超小型パッケージ: X2SON (0.8 × 0.8mm<sup>2</sup>)
- 標準パッケージ: SOT23、SC70、VSSOP
- 広い電源電圧範囲: 1.6V~6.5V
- 静止電流: 5μA
- 短い伝搬遅延: 260ns
- レール・ツー・レールの同相入力電圧
- 内部ヒステリシス
- プッシュプルおよびオープンドレインの出力オプション
- 入力オーバードライブでの位相反転なし
- 動作時周囲温度: -40°C~125°C

## 2 アプリケーション

- 携帯電話およびタブレット
- 携帯用およびバッテリー駆動の機器
- IR 受信機
- レベル変換器
- スレッシュホールド検出器および弁別装置
- ウィンドウ・コンパレータ
- ゼロクロス検出器

## 3 概要

TLV7011/7021 (シングル・チャネル) および TLV7012/7022 (デュアル・チャネル) は、低電圧で動作し、レール・ツー・レール入力をサポートするマイクロパワー・コンパレータです。これらのコンパレータは 0.8mm × 0.8mm の超小型リードレス・パッケージと標準のリード・パッケージで供給され、スマートフォンや他の携帯用またはバッテリー駆動アプリケーションなど、スペースに制約のある設計に適しています。

### X2SONパッケージと、SC70および米10セント硬貨との比較

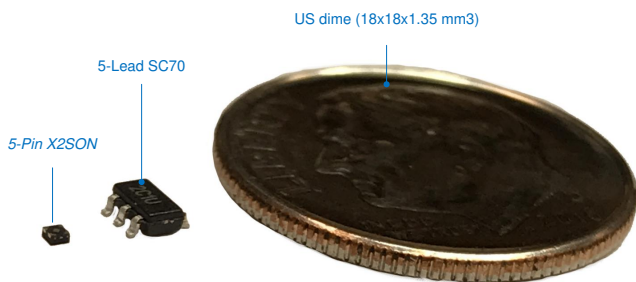

TLV701x および TLV702x は、速度と消費電力の組み合わせが非常に優れており、伝搬遅延は 260ns、静止消費電流は 5μA です。この高速な応答時間と Micro-Power との組み合わせから、電力の限られたシステムでも、フォルト状況を監視して迅速に応答できます。これらのコンパレータの動作電圧範囲は 1.6V~6.5V で、3V および 5V のシステムと互換性があります。

また、これらコンパレータはオーバードライブ入力について出力の位相反転がなく、内部的なヒステリシスを備えています。これらの特長から、このファミリのコンパレータは過酷でノイズの大きな環境において、ゆっくりと変化する入力信号をクリーンなデジタル出力へ変換する必要がある場合に、正確な電圧を監視するため最適です。

### 製品情報<sup>(1)</sup>

型番	パッケージ (ピン数)	本体サイズ(公称)
TLV7011、 TLV7021	X2SON (5)	0.80mm×0.80mm
	SC70 (5)	2.00mm×1.25mm
	SOT-23 (5)	2.90mm×1.60mm
TLV7012、TLV7022	VSSOP (8)	3mm×3mm

(1) 利用可能なすべてのパッケージについては、このデータシートの末尾にある注文情報を参照してください。

### TLV70x1ファミリの低消費電力コンパレータ

型番	出力	I <sub>Q</sub> (標準値)	t <sub>PD</sub> (標準値)
TLV701x	プッシュプル	5μA	260ns
TLV702x	オープンドレイン	5μA	260ns
TLV703x	プッシュプル	335nA	3μs
TLV704x	オープンドレイン	335nA	3μs

### 伝搬遅延とオーバードライブとの関係

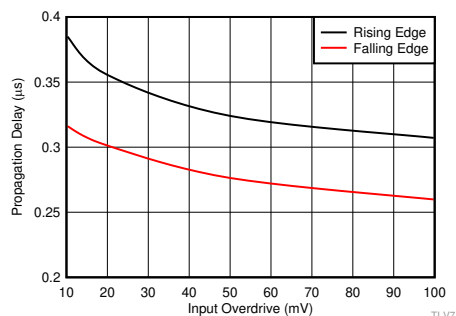

$$T_A = 25^\circ\text{C}, V_{CC} = 5\text{V}, C_L = 15\text{pF}$$



## 目次

1	特長	1	8.1	Overview	17
2	アプリケーション	1	8.2	Functional Block Diagram	17
3	概要	1	8.3	Feature Description	17
4	改訂履歴	2	8.4	Device Functional Modes	17
5	概要 (続き)	4	<b>9</b>	<b>Application and Implementation</b>	<b>19</b>
6	<b>Pin Configuration and Functions</b>	<b>4</b>	9.1	Application Information	19
7	<b>Specifications</b>	<b>6</b>	9.2	Typical Applications	21
7.1	Absolute Maximum Ratings (Single)	6	<b>10</b>	<b>Power Supply Recommendations</b>	<b>26</b>
7.2	Absolute Maximum Ratings (Dual)	6	<b>11</b>	<b>Layout</b>	<b>26</b>
7.3	ESD Ratings	6	11.1	Layout Guidelines	26
7.4	Recommended Operating Conditions (Single)	6	11.2	Layout Example	26
7.5	Recommended Operating Conditions (Dual)	7	<b>12</b>	<b>デバイスおよびドキュメントのサポート</b>	<b>27</b>
7.6	Thermal Information (Single)	7	12.1	デバイス・サポート	27
7.7	Thermal Information (Dual)	7	12.2	関連リンク	27
7.8	Electrical Characteristics (Single)	8	12.3	ドキュメントの更新通知を受け取る方法	27
7.9	Switching Characteristics (Single)	8	12.4	コミュニティ・リソース	27
7.10	Electrical Characteristics (Dual)	9	12.5	商標	27
7.11	Switching Characteristics (Dual)	9	12.6	静電気放電に関する注意事項	27
7.12	Timing Diagrams	9	12.7	Glossary	27
7.13	Typical Characteristics	11	<b>13</b>	<b>メカニカル、パッケージ、および注文情報</b>	<b>27</b>
<b>8</b>	<b>Detailed Description</b>	<b>17</b>			

## 4 改訂履歴

### Revision D (February 2019) から Revision E に変更 Page

• デュアル・チャネル・オプションを追加	1
----------------------	---

### Revision C (March 2018) から Revision D に変更 Page

• 「特長」にリード・パッケージ・オプションを追加	1
• SOT23 パッケージのプレビュー・ステータス 削除	1
• Deleted preview status of SOT23 package	4

### Revision B (November 2017) から Revision C に変更 Page

• プレビューのSC70パッケージを量産データに変更	1
----------------------------	---

### Revision A (July 2017) から Revision B に変更 Page

• 伝播遅延を200nsから260nsに変更	1
• データシートにプレビューのSC70およびSOT-23パッケージを追加	1
• マーケティングの要求に対応して「TLV70x1 ファミリの <i>Micropower</i> コンパレータ」表を追加	1
• 主要な図のタイトルを「伝播遅延とオーバードライブとの関係(TLV7011)」から「伝播遅延とオーバードライブとの関係」に変更	1
• Removed (TLV7011 only) text from several <i>Typical Characteristics</i> graphs	11
• Removed some <i>Typical Characteristics</i> graphs	11
• Added <a href="#">図 14</a>	11
• Added <a href="#">図 21</a>	13
• Added content to the <i>Inputs</i> section	17
• Added the <i>IR Receiver Analog Front End</i> section	22

**2017年5月発行のものから更新**

**Page**

- 
- デバイスのステータスを「事前情報」から「量産データ」に変更 ..... 1
-

## 5 概要 (続き)

TLV701x は、LED の制御または容量性負荷の駆動を行う際に数ミリアンペアの電流をシンクおよびソースできるプッシュプル出力段を備えています。TLV702x にはオープンドレインの出力段があり、 $V_{CC}$  を超える出力レベルが可能であるため、レベル変換器やバイポーラからシングルエンドへのコンバータに適しています。

## 6 Pin Configuration and Functions

DPW Package  
5-Pin X2SON  
Top View

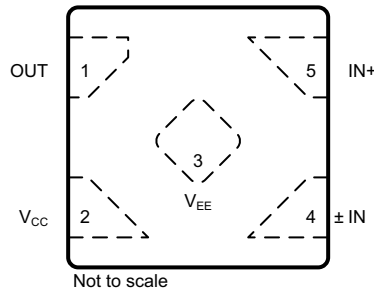

DBV and DCK Package  
5-Pin SOT-23 and SC70  
Top View

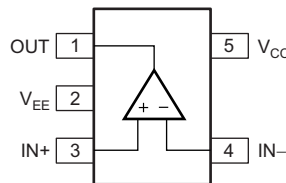

### Pin Functions

NAME	PIN		I/O/P <sup>(1)</sup>	DESCRIPTION
	X2SON	SOT-23, SC70		
OUT	1	1	O	Output
$V_{CC}$	2	5	P	Positive (highest) power supply
$V_{EE}$	3	2	P	Negative (lowest) power supply
IN-	4	4	I	Inverting input
IN+	5	3	I	Noninverting input

(1) I = Input, O = Output, P = Power

**TLV7012/22 DGK Packages  
8-Pin VSSOP  
Top View**

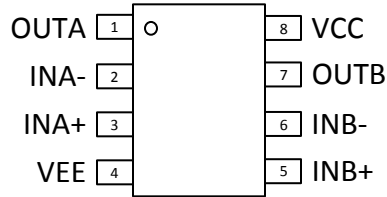

**Pin Functions: TLV7012/22**

PIN		I/O	DESCRIPTION
NAME	NO.		
INA-	2	I	Inverting input, channel A
INA+	3	I	Noninverting input, channel A
INB-	6	I	Inverting input, channel B
INB+	5	I	Noninverting input, channel B
OUTA	1	O	Output, channel A
OUTB	7	O	Output, channel B
VEE	4	—	Negative (lowest) supply or ground (for single-supply operation)
VCC	8	—	Positive (highest) supply

## 7 Specifications

### 7.1 Absolute Maximum Ratings (Single)

over operating free-air temperature range (unless otherwise noted)<sup>(1)</sup>

		MIN	MAX	UNIT
Supply voltage ( $V_S = V_{CC} - V_{EE}$ )			6	V
Input pins (IN+, IN-) <sup>(2)</sup>		$V_{EE} - 0.3$	6	V
Current into Input pins (IN+, IN-) <sup>(2)</sup>			±10	mA
Output (OUT)	TLV7011/7012 <sup>(3)</sup>	$V_{EE} - 0.3$	$V_{CC} + 0.3$	V
	TLV7021/7022	$V_{EE} - 0.3$	6	V
Output short-circuit duration <sup>(4)</sup>			10	s
Junction temperature, $T_J$			150	°C
Storage temperature, $T_{stg}$		-65	150	°C

- (1) Stresses beyond those listed under *Absolute Maximum Ratings* may cause permanent damage to the device. These are stress ratings only, which do not imply functional operation of the device at these or any other conditions beyond those indicated under *Recommended Operating Conditions*. Exposure to absolute-maximum-rated conditions for extended periods may affect device reliability.
- (2) Input terminals are diode-clamped to  $V_{EE}$ . Input signals that can swing 0.3V below  $V_{EE}$  must be current-limited to 10mA or less.
- (3) Output maximum is ( $V_{CC} + 0.3V$ ) or 6V, whichever is less.
- (4) Short-circuit to ground, one comparator per package.

### 7.2 Absolute Maximum Ratings (Dual)

over operating free-air temperature range (unless otherwise noted)<sup>(1)</sup>

		MIN	MAX	UNIT
Supply voltage $V_S = V_{CC} - V_{EE}$		-0.3	7	V
Input pins (IN+, IN-) <sup>(2)</sup>		$V_{EE} - 0.3$	7	V
Current into Input pins (IN+, IN-)			±10	mA
Output (OUT) (TLV7012) <sup>(3)</sup>		$V_{EE} - 0.3$	$V_{CC} + 0.3$	V
Output (OUT) (TLV7022)		$V_{EE} - 0.3$	7	V
Output short-circuit duration <sup>(4)</sup>			10	s
Junction temperature, $T_J$			150	°C
Storage temperature, $T_{stg}$		-65	150	°C

- (1) Stresses beyond those listed under *Absolute Maximum Ratings* may cause permanent damage to the device. These are stress ratings only, which do not imply functional operation of the device at these or any other conditions beyond those indicated under *Recommended Operating Conditions*. Exposure to absolute-maximum-rated conditions for extended periods may affect device reliability.
- (2) Input terminals are diode-clamped to  $V_{EE}$ . Input signals that can swing 0.3V below  $V_{EE}$  must be current-limited to 10mA or less.
- (3) Output maximum is ( $V_{CC} + 0.3 V$ ) or 7 V, whichever is less.
- (4) Short-circuit to ground, one comparator per package.

### 7.3 ESD Ratings

		VALUE	UNIT
$V_{(ESD)}$	Electrostatic discharge	Human-body model (HBM), per ANSI/ESDA/JEDEC JS-001 <sup>(1)</sup>	±2000
		Charged-device model (CDM), per JEDEC specification JESD22-C101 <sup>(2)</sup>	±1000

- (1) JEDEC document JEP155 states that 500-V HBM allows safe manufacturing with a standard ESD control process.
- (2) JEDEC document JEP157 states that 250-V CDM allows safe manufacturing with a standard ESD control process.

### 7.4 Recommended Operating Conditions (Single)

over operating free-air temperature range (unless otherwise noted)

		MIN	NOM	MAX	UNIT
Supply voltage ( $V_S = V_{CC} - V_{EE}$ )		1.6		5.5	V
Input Voltage Range		$V_{EE} - 0.1$		$V_{CC} + 0.2$	V
Ambient temperature, $T_A$		-40		125	°C

## 7.5 Recommended Operating Conditions (Dual)

over operating free-air temperature range (unless otherwise noted)

	MIN	MAX	UNIT
Supply voltage $V_S = V_{CC} - V_{EE}$	1.6	6.5	V
Input voltage range	$V_{CC} - 0.1$	$V_{EE} + 0.2$	V
Ambient temperature, $T_A$	-40	125	°C

## 7.6 Thermal Information (Single)

THERMAL METRIC <sup>(1)</sup>		TLV7011/TLV7021			UNIT
		DPW (X2SON)	DBV (SOT23)	DCK (SC70)	
		5 PINS	5 PINS	5 PINS	
$R_{\theta JA}$	Junction-to-ambient thermal resistance	497.5	306.3	278.8	°C/W
$R_{\theta JC(top)}$	Junction-to-case (top) thermal resistance	275.5	228.4	188.6	°C/W
$R_{\theta JB}$	Junction-to-board thermal resistance	372.2	166.5	113.2	°C/W
$\Psi_{JT}$	Junction-to-top characterization parameter	55.5	138.5	82.3	°C/W
$\Psi_{JB}$	Junction-to-board characterization parameter	370.3	165.3	112.4	°C/W
$R_{\theta JC(bot)}$	Junction-to-case (bottom) thermal resistance	165.1	N/A	N/A	°C/W

(1) For more information about traditional and new thermal metrics, see the [Semiconductor and IC Package Thermal Metrics](#) application report.

## 7.7 Thermal Information (Dual)

THERMAL METRIC <sup>(1)</sup>		TLV7012/TLV7022	UNIT
		DGK (VSSOP)	
		8 PINS	
$R_{\theta JA}$	Junction-to-ambient thermal resistance	211.7	°C/W
$R_{\theta JC(top)}$	Junction-to-case (top) thermal resistance	96.1	°C/W
$R_{\theta JB}$	Junction-to-board thermal resistance	133.5	°C/W
$\Psi_{JT}$	Junction-to-top characterization parameter	28.3	°C/W
$\Psi_{JB}$	Junction-to-board characterization parameter	131.7	°C/W
$R_{\theta JC(bot)}$	Junction-to-case (bottom) thermal resistance	N/A	°C/W

(1) For more information about traditional and new thermal metrics, see the [Semiconductor and IC Package Thermal Metrics](#) application report.

## 7.8 Electrical Characteristics (Single)

$V_S = 1.8\text{ V}$  to  $5\text{ V}$ ,  $V_{CM} = V_S / 2$ ; minimum and maximum values are at  $T_A = -40^\circ\text{C}$  to  $+125^\circ\text{C}$  (unless otherwise noted). Typical values are at  $T_A = 25^\circ\text{C}$ .

PARAMETER		TEST CONDITIONS	MIN	TYP	MAX	UNIT
$V_{IO}$	Input offset voltage	$V_S = 1.8\text{ V}$ and $5\text{ V}$ , $V_{CM} = V_S / 2$		$\pm 0.5$	$\pm 8$	mV
$V_{HYS}$	Hysteresis	$V_S = 1.8\text{ V}$ and $5\text{ V}$ , $V_{CM} = V_S / 2$	1.2	4.2	14	mV
$V_{CM}$	Common-mode voltage range	$V_S = 2.5\text{ V}$ to $5\text{ V}$		$V_{EE}$	$V_{CC} + 0.1$	V
		$V_S = 1.8\text{ V}$ to $2.5\text{ V}$	$V_{EE} + 0.1$		$V_{CC} + 0.1$	
$I_B$	Input bias current			5		pA
$I_{OS}$	Input offset current			1		pA
$V_{OH}$	Output voltage high (for TLV7011 only)	$V_S = 5\text{ V}$ , $I_O = 3\text{ mA}$	4.7	4.8		V
$V_{OL}$	Output voltage low	$V_S = 5\text{ V}$ , $I_O = 3\text{ mA}$		120	220	mV
$I_{LKG}$	Open-drain output leakage current (TLV7021 only)	$V_S = 5\text{ V}$ , $V_{ID} = +0.1\text{ V}$ (output high), $V_{PULLUP} = V_{CC}$		100		pA
CMRR	Common-mode rejection ratio	$V_{EE} < V_{CM} < V_{CC}$ , $V_S = 5\text{ V}$		78		dB
PSRR	Power supply rejection ratio	$V_S = 1.8\text{ V}$ to $5\text{ V}$ , $V_{CM} = V_S / 2$		78		dB
$I_{SC}$	Short-circuit current	$V_S = 5\text{ V}$ , sourcing		65		mA
		$V_S = 5\text{ V}$ , sinking		44		
$I_{CC}$	Supply current	$V_S = 1.8\text{ V}$ , no load, $V_{ID} = -0.1\text{ V}$ (Output Low)		5	10	$\mu\text{A}$

## 7.9 Switching Characteristics (Single)

Typical values are at  $T_A = 25^\circ\text{C}$ ,  $V_{CC} = 5\text{ V}$ ,  $V_{CM} = 2.5\text{ V}$ ;  $C_L = 15\text{ pF}$ , input overdrive =  $100\text{ mV}$  (unless otherwise noted).

PARAMETER		TEST CONDITIONS	MIN	TYP	MAX	UNIT
$t_{PHL}$	Propagation delay time, high-to-low ( $R_P = 2.5\text{ k}\Omega$ TLV7021 only)	Midpoint of input to midpoint of output, $V_{OD} = 100\text{ mV}$		260		ns
$t_{PLH}$	Propagation delay time, low-to-high ( $R_P = 2.5\text{ k}\Omega$ TLV7021 only)	Midpoint of input to midpoint of output, $V_{OD} = 100\text{ mV}$		310		ns
$t_R$	Rise time (for TLV7011 only)	20% to 80%		5		ns
$t_F$	Fall time	80% to 20%		5		ns
$t_{ON}$	Power-up time <sup>(1)</sup>			20		$\mu\text{s}$

(1) During power on,  $V_S$  must exceed  $1.6\text{ V}$  for  $t_{ON}$  before the output tracks the input.



## 7.10 Electrical Characteristics (Dual)

$V_S = 1.8\text{ V}$  to  $5\text{ V}$ ,  $V_{CM} = V_S / 2$ ; minimum and maximum values are at  $T_A = -40^\circ\text{C}$  to  $+125^\circ\text{C}$  (unless otherwise noted).

Typical values are at  $T_A = 25^\circ\text{C}$ .

PARAMETER		TEST CONDITIONS	MIN	TYP	MAX	UNIT
$V_{IO}$	Input Offset Voltage	$V_S = 1.8\text{ V}$ and $5\text{ V}$ , $V_{CM} = V_S / 2$		$\pm 0.1$	$\pm 8$	mV
$V_{HYS}$	Hysteresis	$V_S = 1.8\text{ V}$ and $5\text{ V}$ , $V_{CM} = V_S / 2$	2	9	15	mV
$V_{CM}$	Common-mode voltage range		$V_{EE}$		$V_{CC} + 0.1$	V
$I_B$	Input bias current			2		pA
$I_{OS}$	Input offset current			1		pA
$V_{OH}$	Output voltage high (for TLV7012 only)	$V_S = 5\text{ V}$ , $V_{EE} = 0\text{ V}$ , $I_O = 3\text{ mA}$	4.65	4.8		V
$V_{OL}$	Output voltage low	$V_S = 5\text{ V}$ , $V_{EE} = 0\text{ V}$ , $I_O = 3\text{ mA}$		250	350	mV
$I_{LKG}$	Open-drain output leakage current (TLV7022 only)	$V_S = 5\text{ V}$ , $V_{ID} = +0.1\text{ V}$ (output high), $V_{PULLUP} = V_{CC}$		100		pA
CMRR	Common-mode rejection ratio	$V_{EE} < V_{CM} < V_{CC}$ , $V_S = 5\text{ V}$		73		dB
PSRR	Power supply rejection ratio	$V_S = 1.8\text{ V}$ to $5\text{ V}$ , $V_{CM} = V_S / 2$		77		dB
$I_{SC}$	Short-circuit current	$V_S = 5\text{ V}$ , sourcing (for TLV7012 only)		29		mA
		$V_S = 5\text{ V}$ , sinking		33		
$I_{CC}$	Supply current / Channel	$V_S = 1.8\text{ V}$ , no load, $V_{ID} = -0.1\text{ V}$ (Output Low)		4.7	9	$\mu\text{A}$

## 7.11 Switching Characteristics (Dual)

Typical values are at  $T_A = 25^\circ\text{C}$ ,  $V_S = 5\text{ V}$ ,  $V_{CM} = V_S / 2$ ;  $C_L = 15\text{ pF}$ , input overdrive =  $100\text{ mV}$  (unless otherwise noted).

PARAMETER		TEST CONDITIONS	MIN	TYP	MAX	UNIT
$t_{PHL}$	Propagation delay time, high to low (RP = $4.99\text{ k}\Omega$ TLV7022 only) <sup>(1)</sup>	Midpoint of input to midpoint of output, $V_{OD} = 100\text{ mV}$		310		ns
$t_{PLH}$	Propagation delay time, low to high (RP = $4.99\text{ k}\Omega$ TLV7022 only) <sup>(1)</sup>	Midpoint of input to midpoint of output, $V_{OD} = 100\text{ mV}$		260		ns
$t_R$	Rise time (TLV7012 only)	Measured from 20% to 80%		5		ns
$t_F$	Fall time	Measured from 20% to 80%		5		ns
$t_{ON}$	Power-up time	During power on, $V_{CC}$ must exceed $1.6\text{ V}$ for $200\text{ }\mu\text{s}$ before the output is in correct state.		20		$\mu\text{s}$

(1) The lower limit for RP is  $650\text{ }\Omega$

## 7.12 Timing Diagrams



图 1. Start-Up Time Timing Diagram ( $IN+ > IN-$ )

**Timing Diagrams (continued)**

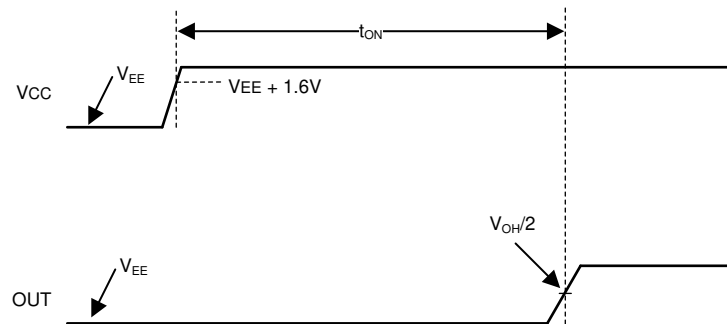
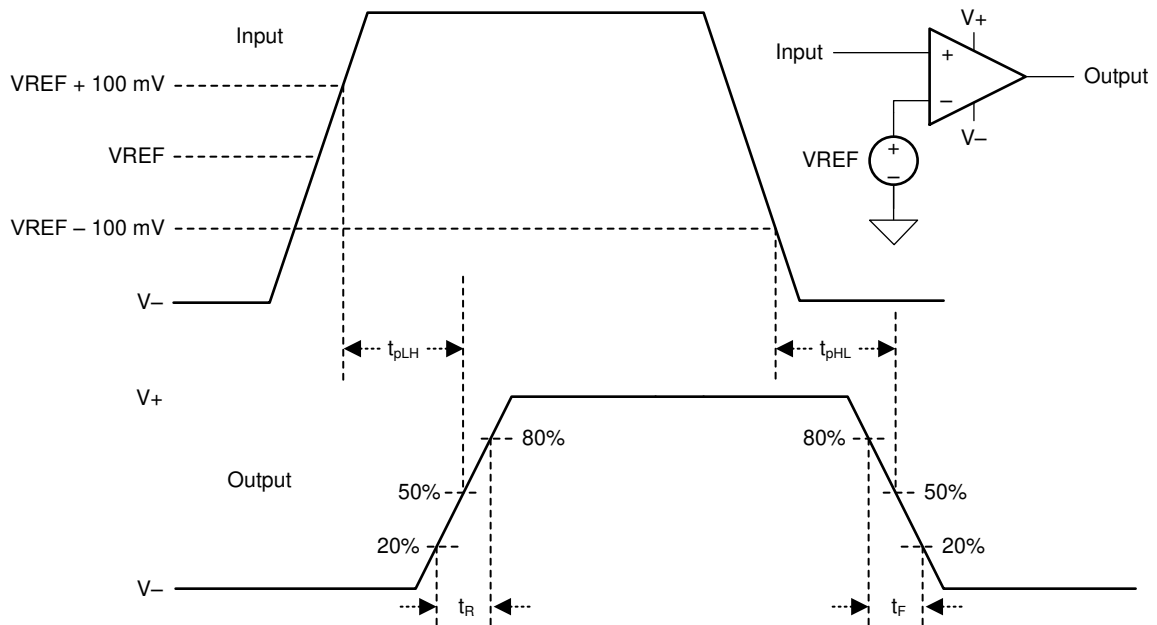

**Figure 2. Propagation Delay Timing Diagram**

### 7.13 Typical Characteristics

$T_A = 25^\circ\text{C}$ ,  $V_{CC} = 5\text{ V}$ ,  $V_{EE} = 0\text{ V}$ ,  $V_{CM} = V_{CC}/2$ ,  $C_L = 15\text{ pF}$

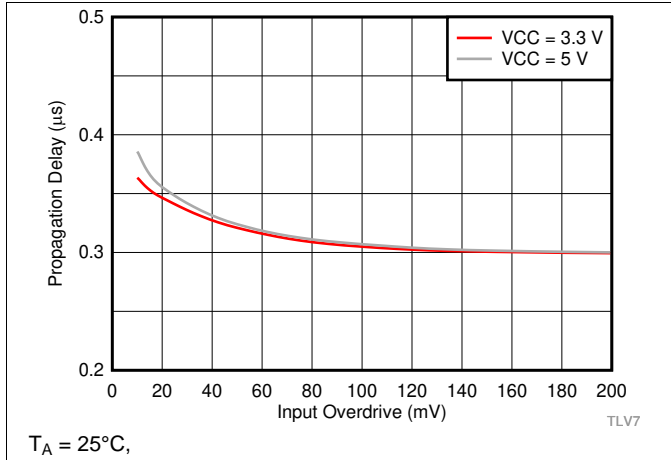

Figure 3. TLV7011 Propagation Delay (L-H) vs. Input Overdrive

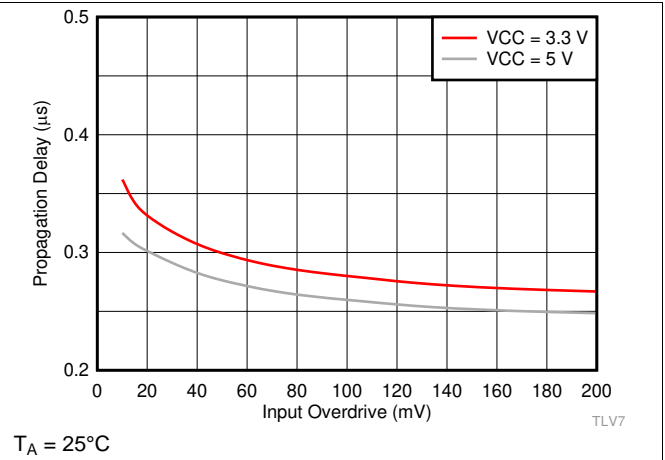

Figure 4. Propagation Delay (H-L) vs. Input Overdrive

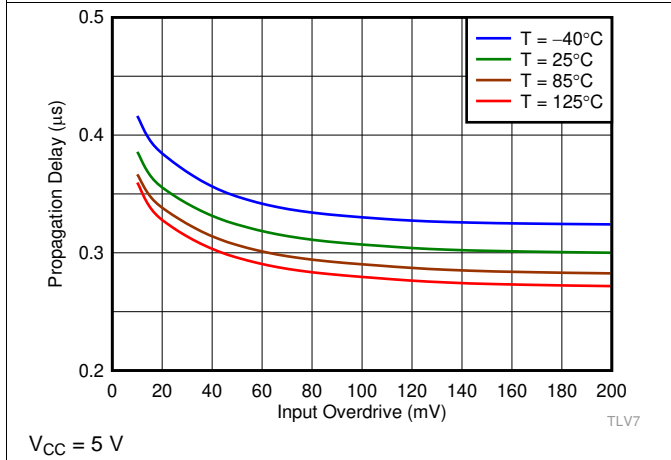

Figure 5. TLV7011 Propagation Delay (L-H) vs. Input Overdrive

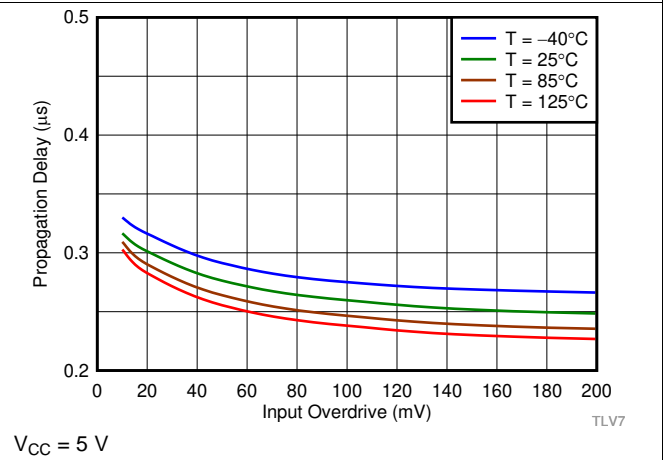

Figure 6. Propagation Delay (H-L) vs. Input Overdrive

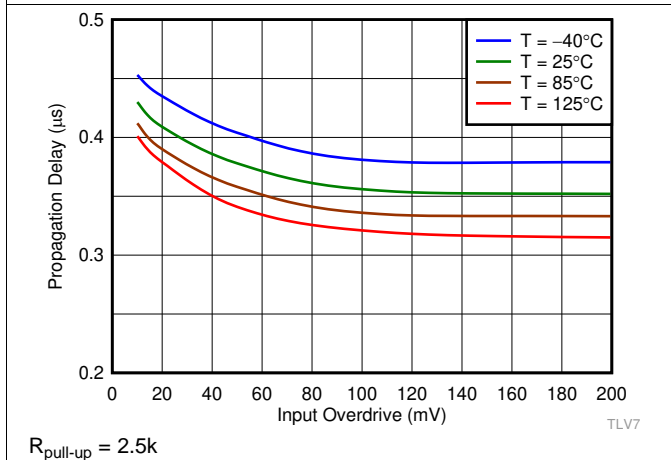

Figure 7. TLV7021 Propagation Delay (L-H) vs. Input Overdrive

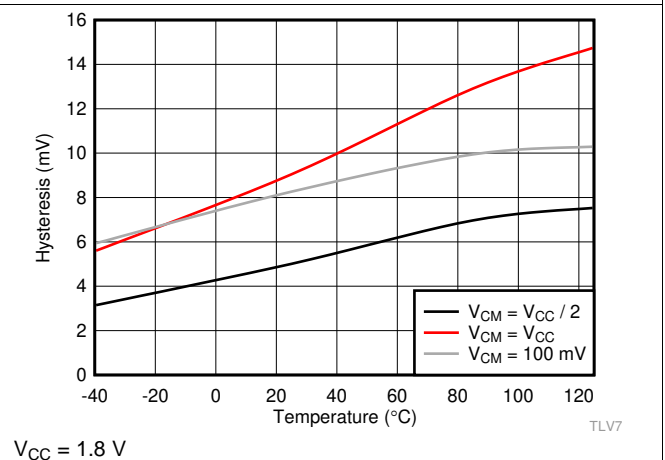
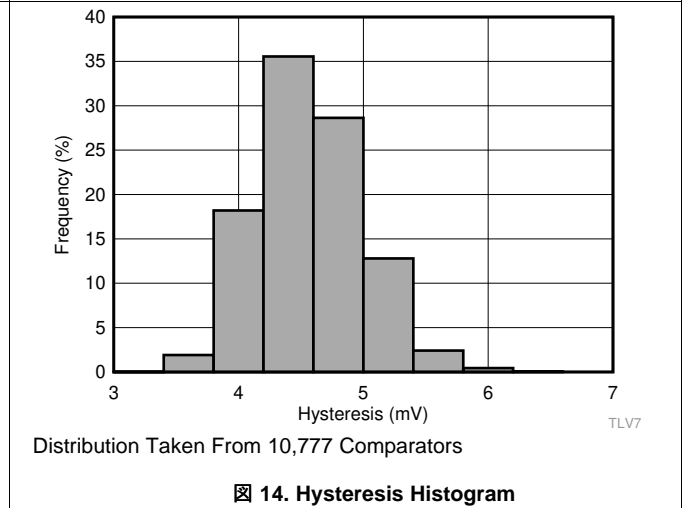
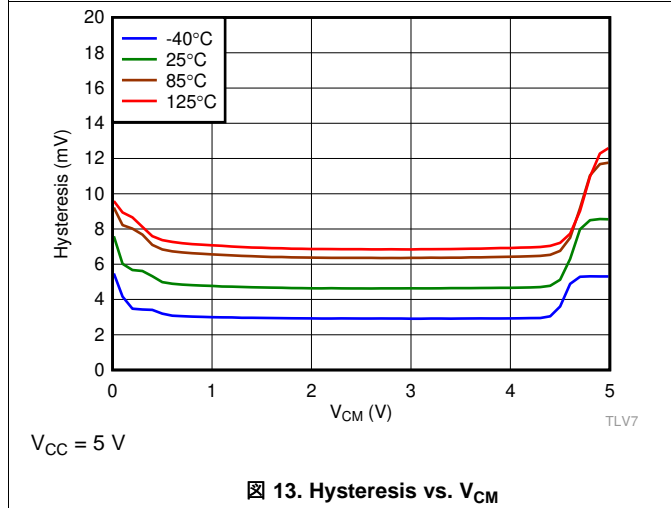
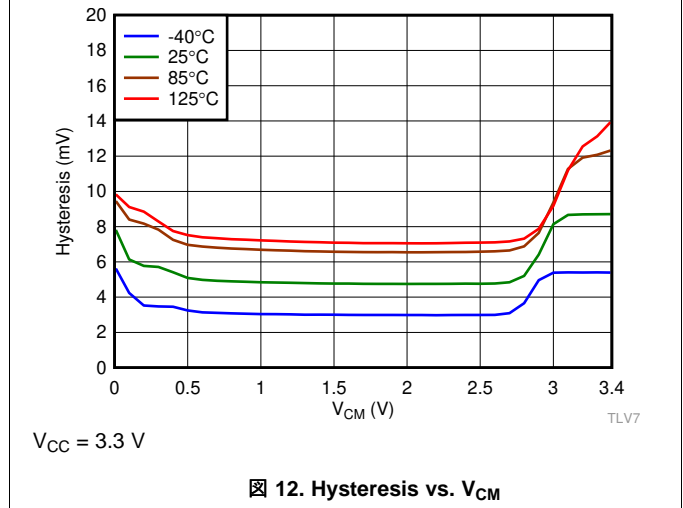
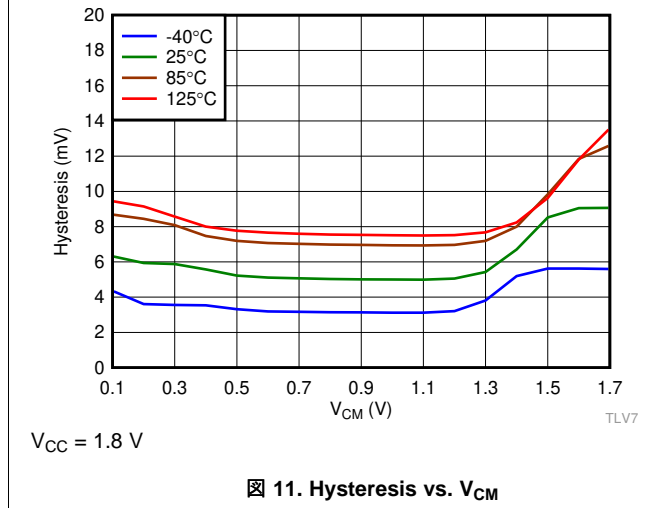
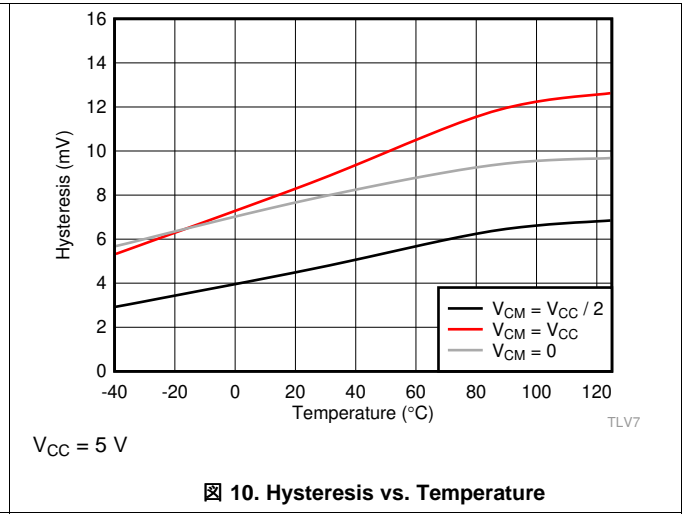
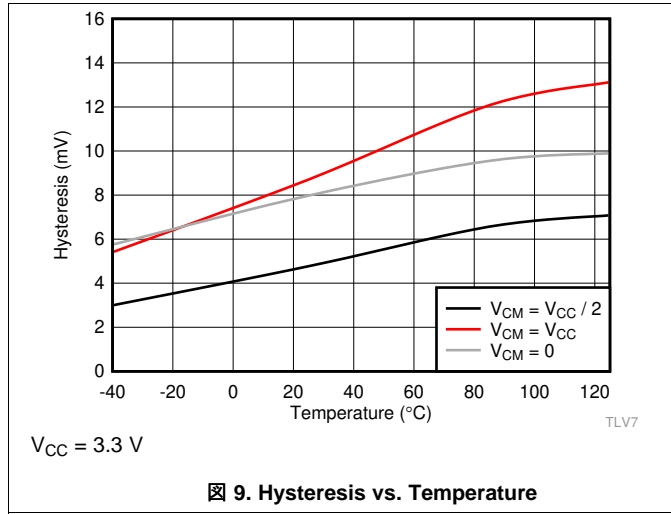

Figure 8. Hysteresis vs. Temperature

### Typical Characteristics (continued)

$T_A = 25^\circ\text{C}$ ,  $V_{CC} = 5\text{ V}$ ,  $V_{EE} = 0\text{ V}$ ,  $V_{CM} = V_{CC}/2$ ,  $C_L = 15\text{ pF}$



**Typical Characteristics (continued)**

$T_A = 25^\circ\text{C}$ ,  $V_{CC} = 5\text{ V}$ ,  $V_{EE} = 0\text{ V}$ ,  $V_{CM} = V_{CC}/2$ ,  $C_L = 15\text{ pF}$

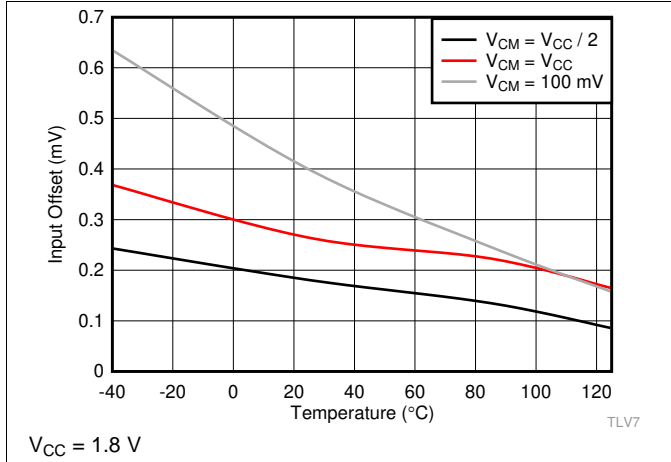

**15. Input Offset vs. Temperature**

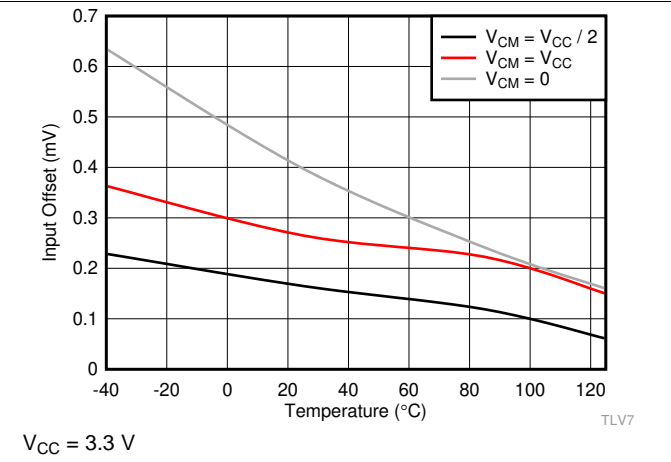

**16. Input Offset vs. Temperature**

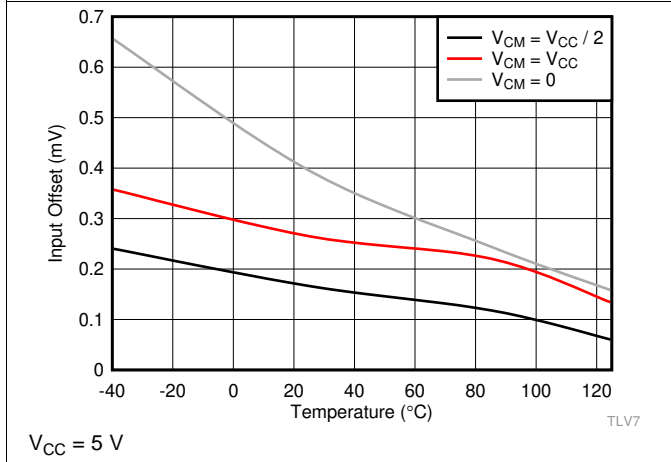

**17. Input Offset vs. Temperature**

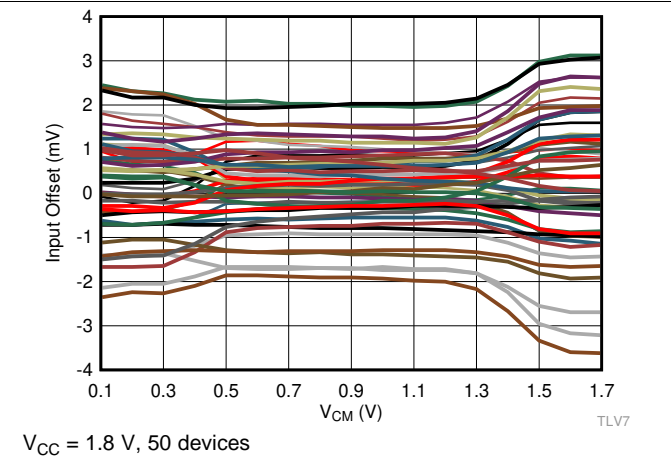

**18. Input Offset Voltage vs.  $V_{CM}$**

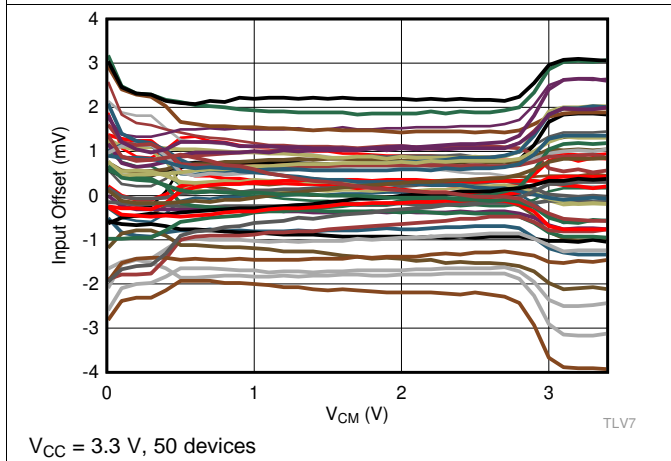

**19. Input Offset Voltage vs.  $V_{CM}$**

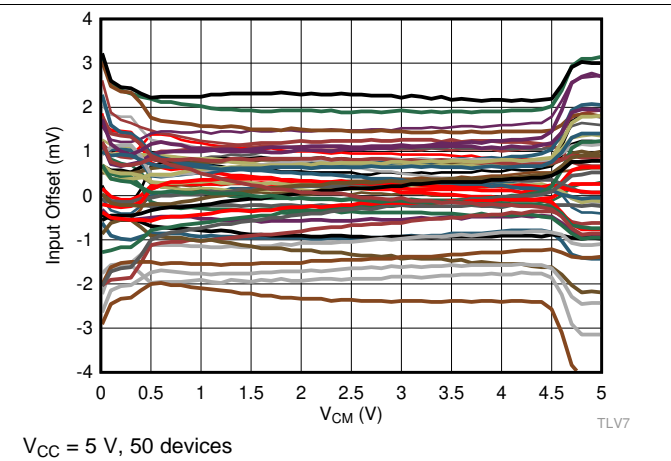

**20. Input Offset Voltage vs.  $V_{CM}$**

### Typical Characteristics (continued)

$T_A = 25^\circ\text{C}$ ,  $V_{CC} = 5\text{ V}$ ,  $V_{EE} = 0\text{ V}$ ,  $V_{CM} = V_{CC}/2$ ,  $C_L = 15\text{ pF}$

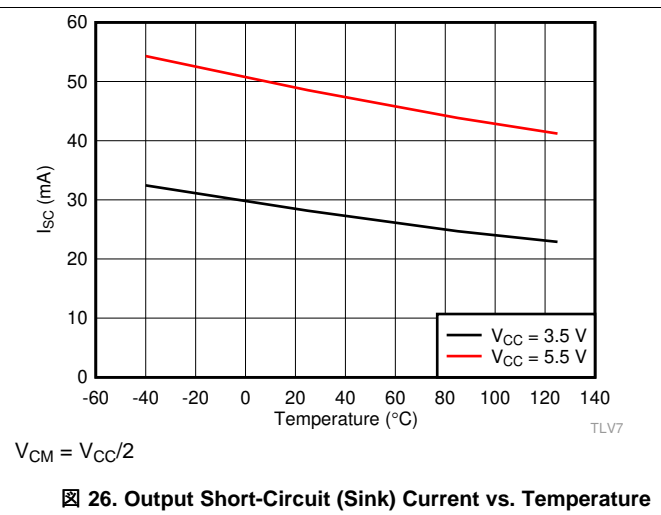
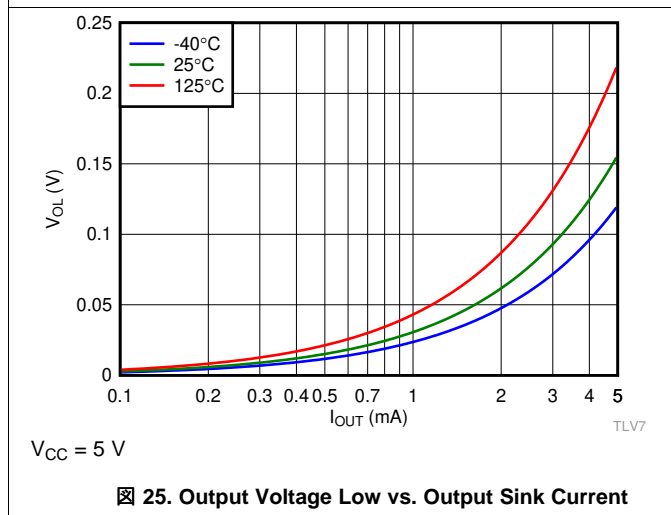
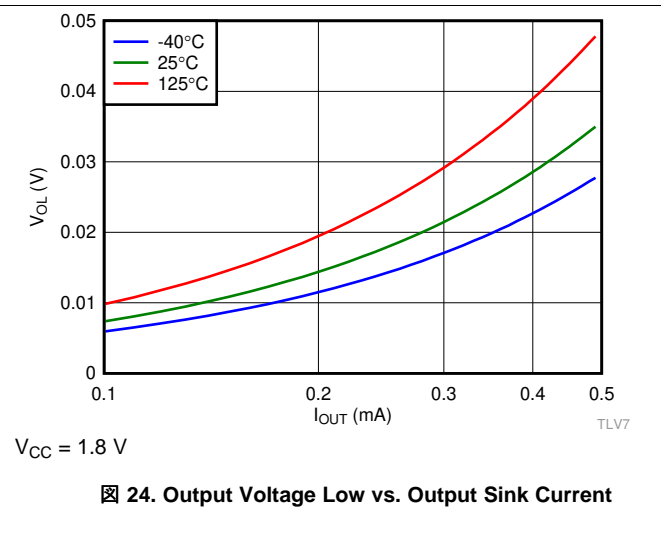
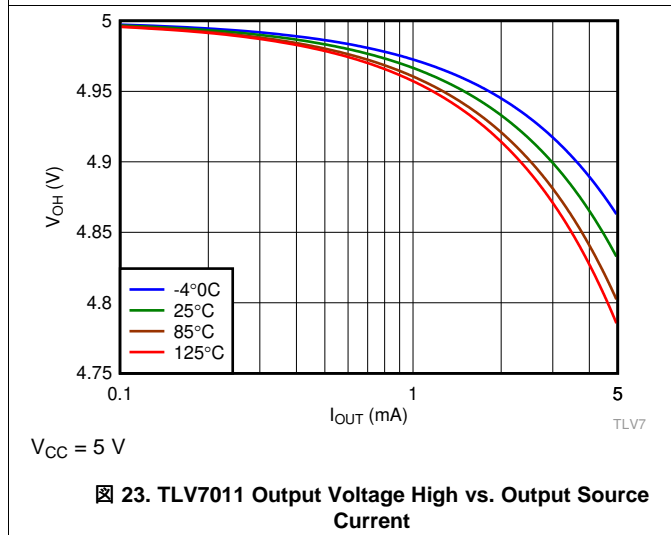
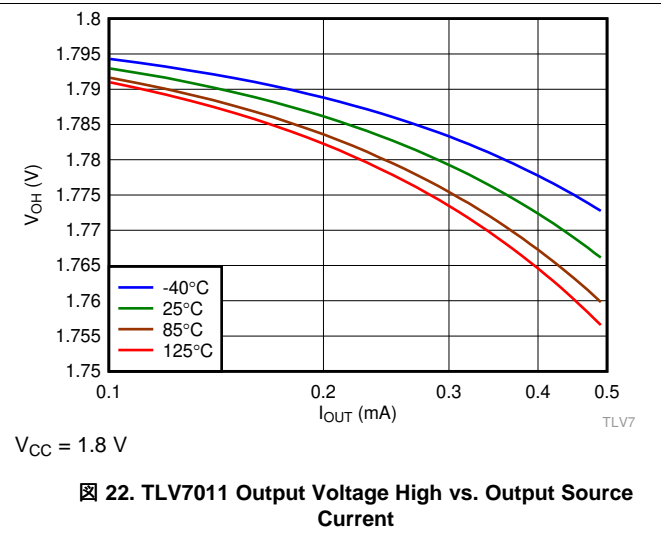
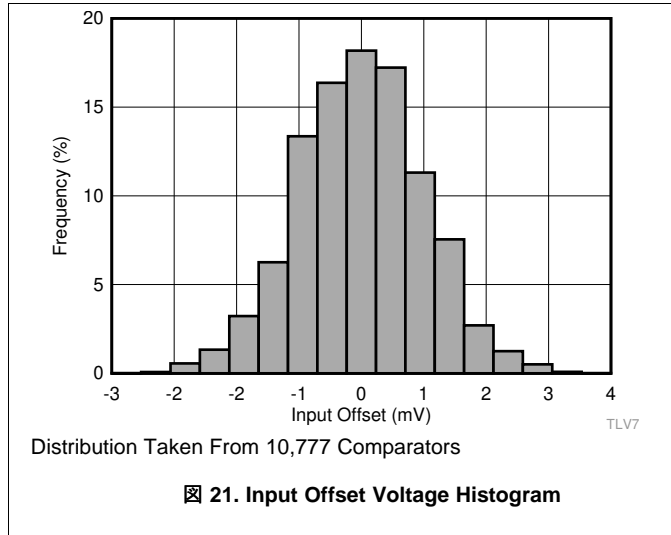

Typical Characteristics (continued)

$T_A = 25^\circ\text{C}$ ,  $V_{CC} = 5\text{ V}$ ,  $V_{EE} = 0\text{ V}$ ,  $V_{CM} = V_{CC}/2$ ,  $C_L = 15\text{ pF}$

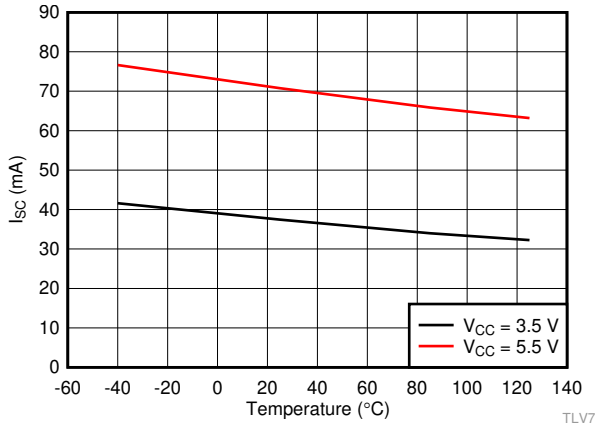

$V_{CM} = V_{CC}/2$

Figure 27. TLV7011 Output Short-Circuit (Source) Current vs. Temperature

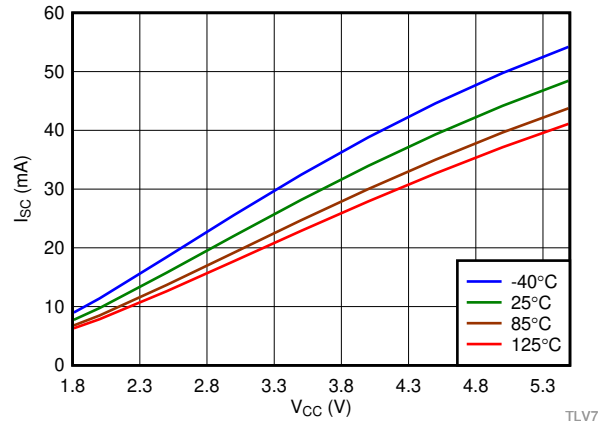

$V_{CM} = V_{CC}/2$

Figure 28. Output Short Circuit (Sink) vs.  $V_{CC}$

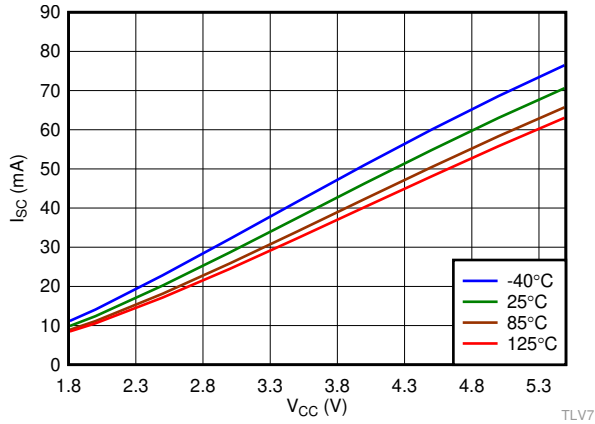

$V_{CM} = V_{CC}/2$

Figure 29. TLV7011 Output Short Circuit (Source) vs.  $V_{CC}$

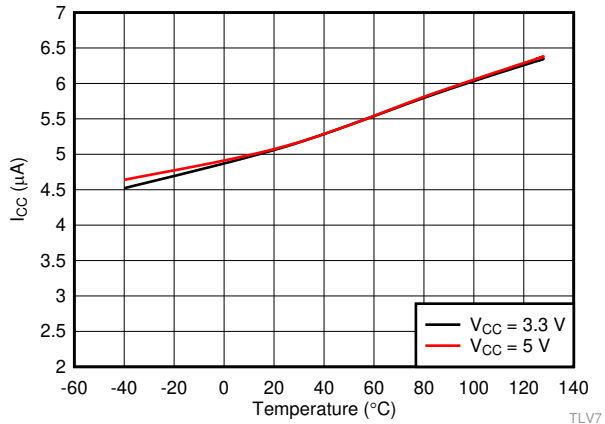

$V_{CM} = V_{CC}/2$

Figure 30.  $I_{CC}$  vs. Temperature

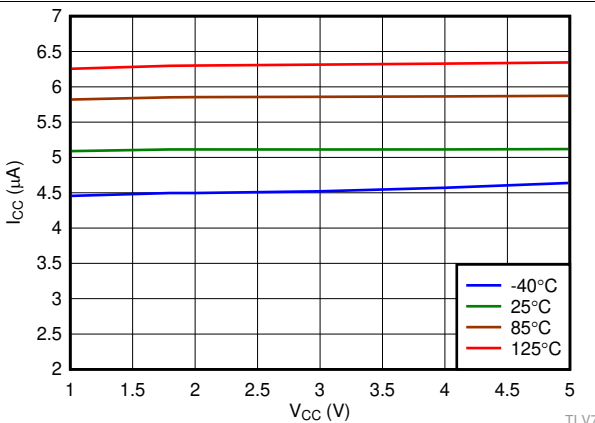

$V_{CM} = V_{CC}/2$

Figure 31.  $I_{CC}$  vs.  $V_{CC}$

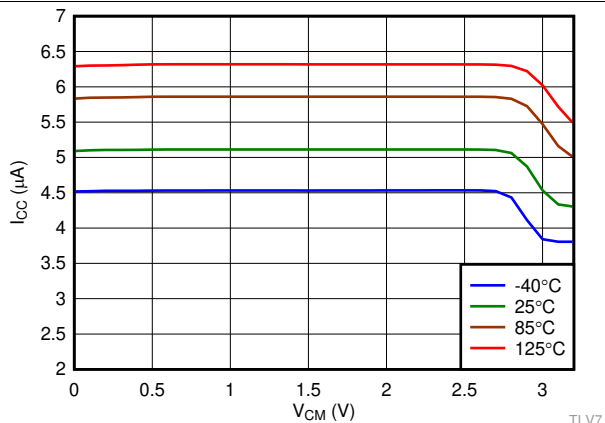

$V_{CC} = 3.3\text{ V}$

Figure 32.  $I_{CC}$  vs.  $V_{CM}$

**Typical Characteristics (continued)**

$T_A = 25^\circ\text{C}$ ,  $V_{CC} = 5\text{ V}$ ,  $V_{EE} = 0\text{ V}$ ,  $V_{CM} = V_{CC}/2$ ,  $C_L = 15\text{ pF}$

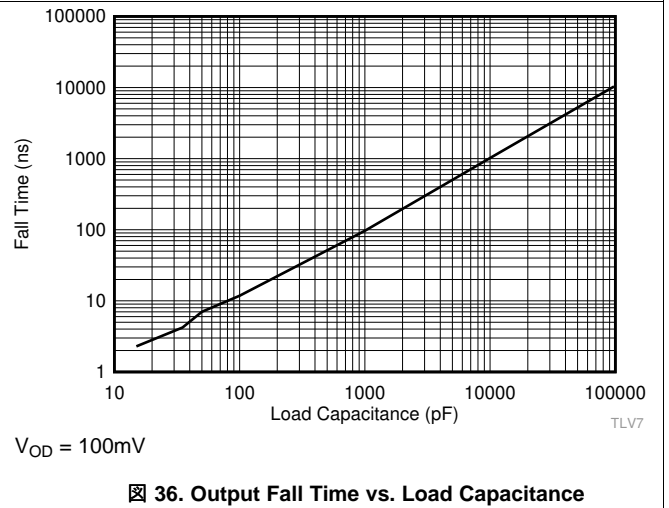
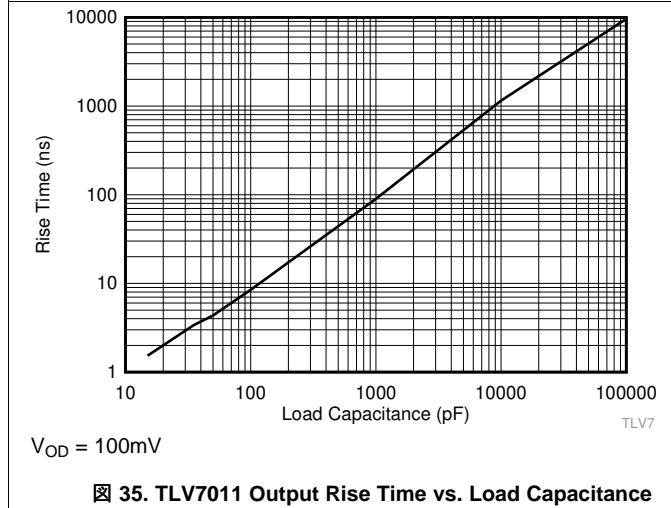
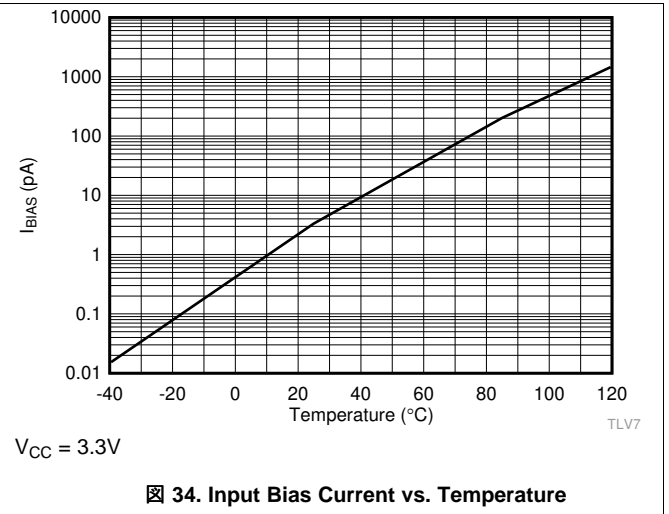
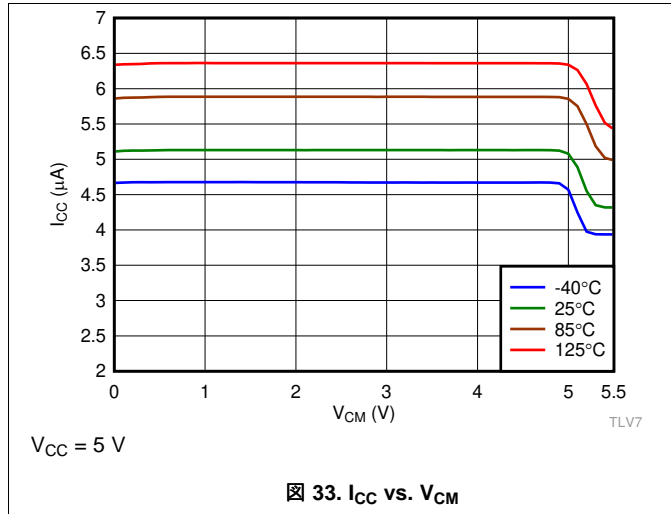



## 8 Detailed Description

### 8.1 Overview

The TLV701x and TLV702x devices are single-channel, micro-power comparators with push-pull and open-drain outputs. Operating down to 1.6 V and consuming only 5  $\mu$ A, the TLV701x and TLV702x are ideally suited for portable and industrial applications. The comparators are available in leadless and leaded packages to offer significant board space saving in space-challenged designs.

### 8.2 Functional Block Diagram

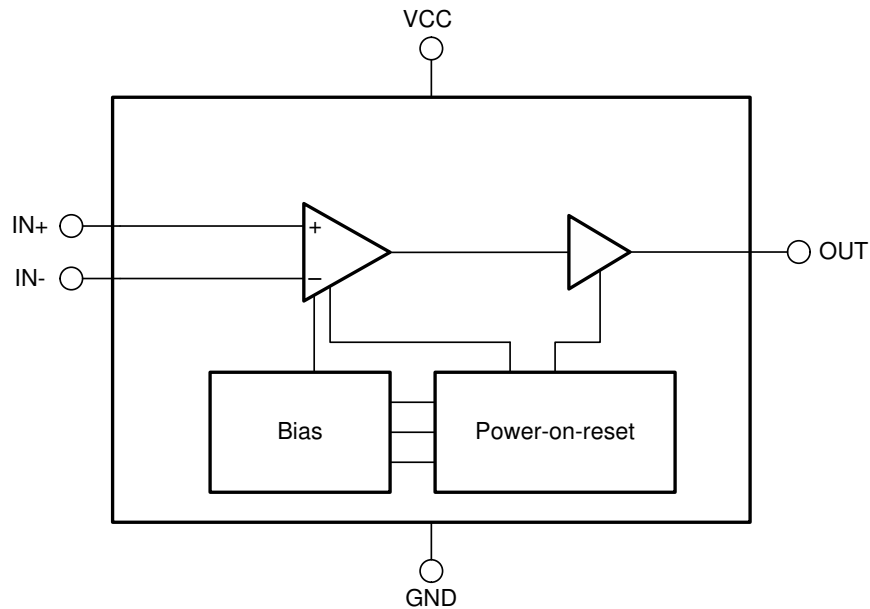

Copyright © 2017, Texas Instruments Incorporated

### 8.3 Feature Description

The TLV701x (push-pull) and TLV702x (open-drain) devices are micro-power comparators that are capable of operating at low voltages. The TLV701x and TLV702x feature a rail-to-rail input stage capable of operating up to 100 mV beyond the VCC power supply rail. The comparators also feature a push-pull and open-drain output stage with internal hysteresis.

### 8.4 Device Functional Modes

The TLV701x and TLV702x have a Power-on-Reset (POR) circuit. While the power supply ( $V_S$ ) is ramping up or ramping down, the POR circuitry will be activated.

For the TLV701x, the POR circuit will hold the output low (at  $V_{EE}$ ) while activated.

For the TLV702x, the POR circuit will keep the output high impedance (logical high) while activated.

When the supply voltage is greater than, or equal to, the minimum supply voltage, the comparator output reflects the state of the differential input ( $V_{ID}$ ).

#### 8.4.1 Inputs

The TLV701x and TLV702x input common-mode extends from  $V_{EE}$  to 100 mV above  $V_{CC}$ . The differential input voltage ( $V_{ID}$ ) can be any voltage within these limits. No phase-inversion of the comparator output will occur when the input pins exceed  $V_{CC}$  and  $V_{EE}$ .

## Device Functional Modes (continued)

While TI recommends operating the TLV701x and TLV702x within the specified common-mode range, the inputs are fault tolerant to voltages up to 5.5 V independent of the applied  $V_{CC}$  value. Fault tolerant is defined as maintaining the same high input impedance when  $V_{CC}$  is unpowered or within the recommended operating range. Because the inputs of the TLV701x and TLV702x are fault tolerant, the inputs to the comparator can be any value between 0 V and 5.5 V while  $V_{CC}$  is ramping up. This feature allows any supply and input driven sequence as long as the input value and supply are within the specified ranges. In this case, no current limiting resistor is required. This is possible since the  $V_{CC}$  is isolated from the inputs such that it maintains its value even when a higher voltage is applied to the input.

The input bias current is typically 1 pA for input voltages between  $V_{CC}$  and  $V_{EE}$ . The comparator inputs are protected from undervoltage by internal diodes connected to  $V_{EE}$ . As the input voltage goes under  $V_{EE}$ , the protection diodes become forward biased and begin to conduct causing the input bias current to increase exponentially. Input bias current typically doubles for 10°C temperature increases.

### 8.4.2 Internal Hysteresis

The device hysteresis transfer curve is shown in [Figure 37](#). This curve is a function of three components:  $V_{TH}$ ,  $V_{OS}$ , and  $V_{HYST}$ :

- $V_{TH}$  is the actual set voltage or threshold trip voltage.
- $V_{OS}$  is the internal offset voltage between  $V_{IN+}$  and  $V_{IN-}$ . This voltage is added to  $V_{TH}$  to form the actual trip point at which the comparator must respond to change output states.
- $V_{HYST}$  is the internal hysteresis (or trip window) that is designed to reduce comparator sensitivity to noise (4.2 mV for the TLV7011).

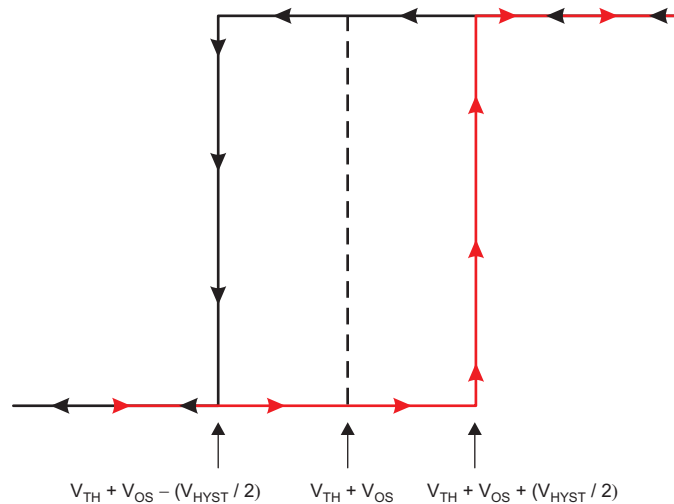

**Figure 37. Hysteresis Transfer Curve**

### 8.4.3 Output

The TLV701x feature a push-pull output stage eliminating the need for an external pull-up resistor. On the other hand, the TLV702x feature an open-drain output stage enabling the output logic levels to be pulled up to an external source independent of the supply voltage.

## 9 Application and Implementation

### 注

Information in the following applications sections is not part of the TI component specification, and TI does not warrant its accuracy or completeness. TI's customers are responsible for determining suitability of components for their purposes. Customers should validate and test their design implementation to confirm system functionality.

### 9.1 Application Information

The TLV701x and TLV702x are micro-power comparators with reasonable response time. The comparators have a rail-to-rail input stage that can monitor signals beyond the positive supply rail with integrated hysteresis. When higher levels of hysteresis are required, positive feedback can be externally added. The push-pull output stage of the TLV701x is optimal for reduced power budget applications and features no shoot-through current. When level shifting or wire-ORing of the comparator outputs is needed, the TLV702x with its open-drain output stage is well suited to meet the system needs. In either case, the wide operating voltage range, low quiescent current, and micro-package of the TLV701x and TLV702x make these comparators excellent candidates for battery-operated and portable, handheld designs.

#### 9.1.1 Inverting Comparator With Hysteresis for TLV701x

The inverting comparator with hysteresis requires a three-resistor network that is referenced to the comparator supply voltage ( $V_{CC}$ ), as shown in [Figure 38](#). When  $V_{IN}$  at the inverting input is less than  $V_A$ , the output voltage is high (for simplicity, assume  $V_O$  switches as high as  $V_{CC}$ ). The three network resistors can be represented as  $R1 \parallel R3$  in series with  $R2$ . [Equation 1](#) defines the high-to-low trip voltage ( $V_{A1}$ ).

$$V_{A1} = V_{CC} \times \frac{R2}{(R1 \parallel R3) + R2} \quad (1)$$

When  $V_{IN}$  is greater than  $V_A$ , the output voltage is low, very close to ground. In this case, the three network resistors can be presented as  $R2 \parallel R3$  in series with  $R1$ . Use [Equation 2](#) to define the low to high trip voltage ( $V_{A2}$ ).

$$V_{A2} = V_{CC} \times \frac{R2 \parallel R3}{R1 + (R2 \parallel R3)} \quad (2)$$

[Equation 3](#) defines the total hysteresis provided by the network.

$$\Delta V_A = V_{A1} - V_{A2} \quad (3)$$

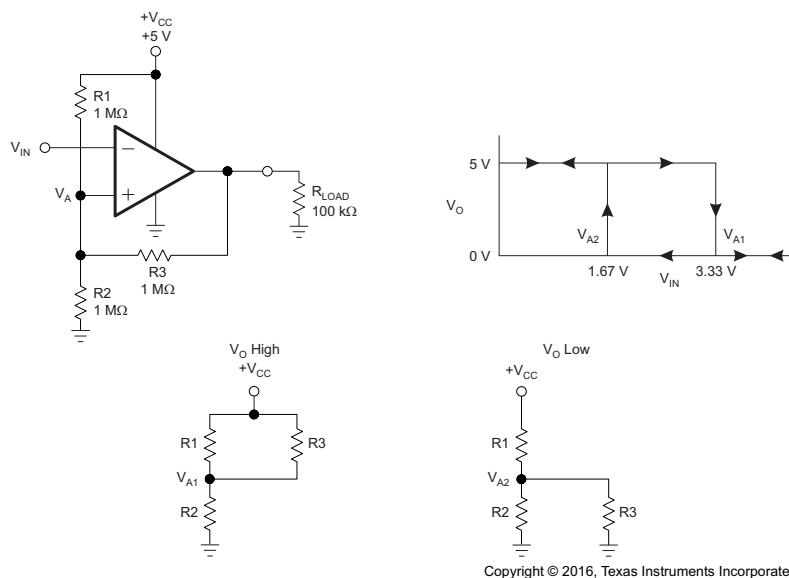

**Figure 38. TLV701x in an Inverting Configuration With Hysteresis**

## Application Information (continued)

### 9.1.2 Noninverting Comparator With Hysteresis for TLV701x

A noninverting comparator with hysteresis requires a two-resistor network, as shown in [Figure 39](#), and a voltage reference ( $V_{REF}$ ) at the inverting input. When  $V_{IN}$  is low, the output is also low. For the output to switch from low to high,  $V_{IN}$  must rise to  $V_{IN1}$ . Use [Equation 4](#) to calculate  $V_{IN1}$ .

$$V_{IN1} = R1 \times \frac{V_{REF}}{R2} + V_{REF} \tag{4}$$

When  $V_{IN}$  is high, the output is also high. For the comparator to switch back to a low state,  $V_{IN}$  must drop to  $V_{IN2}$  such that  $V_A$  is equal to  $V_{REF}$ . Use [Equation 5](#) to calculate  $V_{IN2}$ .

$$V_{IN2} = \frac{V_{REF} (R1 + R2) - V_{CC} \times R1}{R2} \tag{5}$$

The hysteresis of this circuit is the difference between  $V_{IN1}$  and  $V_{IN2}$ , as shown in [Equation 6](#).

$$\Delta V_{IN} = V_{CC} \times \frac{R1}{R2} \tag{6}$$

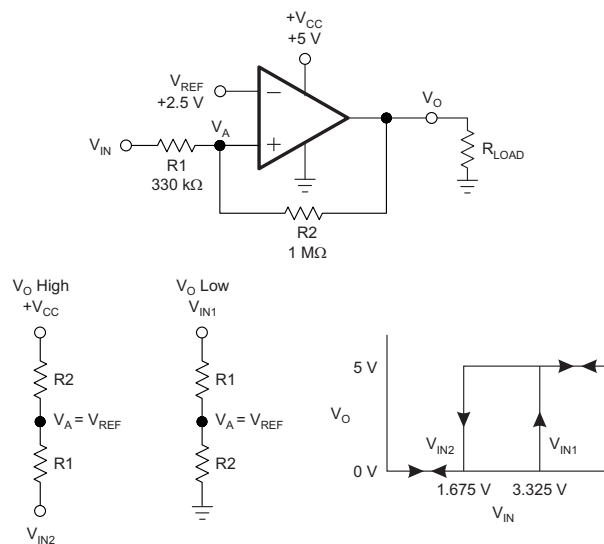

Copyright © 2016, Texas Instruments Incorporated

**Figure 39. TLV701x in a Noninverting Configuration With Hysteresis**

## 9.2 Typical Applications

### 9.2.1 Window Comparator

Window comparators are commonly used to detect undervoltage and overvoltage conditions.  40 shows a simple window comparator circuit.

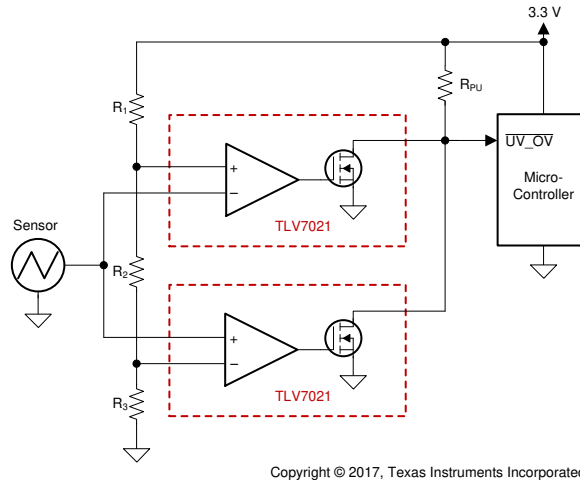

 40. Window Comparator

#### 9.2.1.1 Design Requirements

For this design, follow these design requirements:

- Alert (logic low output) when an input signal is less than 1.1 V
- Alert (logic low output) when an input signal is greater than 2.2 V
- Alert signal is active low
- Operate from a 3.3-V power supply

#### 9.2.1.2 Detailed Design Procedure

Configure the circuit as shown in  40. Connect  $V_{CC}$  to a 3.3-V power supply and  $V_{EE}$  to ground. Make R1, R2 and R3 each 10-M $\Omega$  resistors. These three resistors are used to create the positive and negative thresholds for the window comparator ( $V_{TH+}$  and  $V_{TH-}$ ). With each resistor being equal,  $V_{TH+}$  is 2.2 V and  $V_{TH-}$  is 1.1 V. Large resistor values such as 10-M $\Omega$  are used to minimize power consumption. The sensor output voltage is applied to the inverting and noninverting inputs of the two TLV702x's. The TLV7021 is used for its open-drain output configuration. Using the TLV702x allows the two comparator outputs to be Wire-Ored together. The respective comparator outputs will be low when the sensor is less than 1.1 V or greater than 2.2 V.  $V_{OUT}$  will be high when the sensor is in the range of 1.1 V to 2.2 V.

## Typical Applications (continued)

### 9.2.1.3 Application Curve

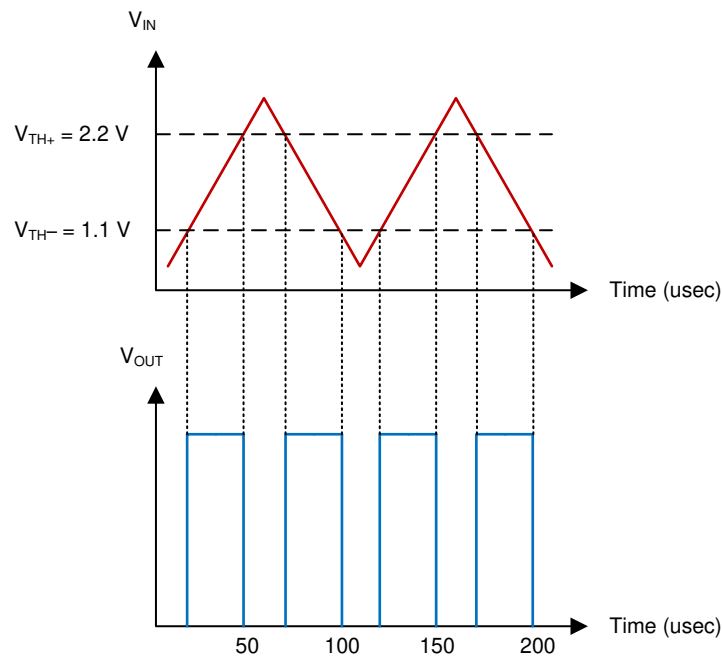
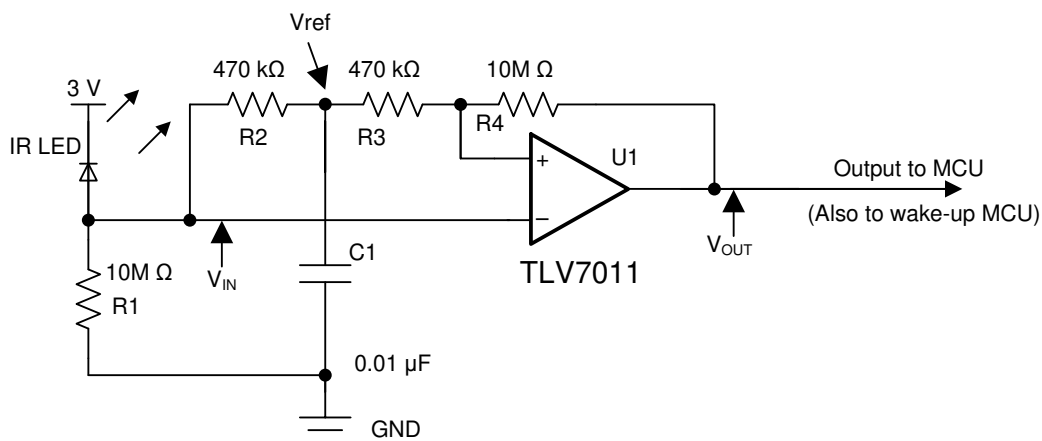

Figure 41. Window Comparator Results

### 9.2.2 IR Receiver Analog Front End

A single TLV7011 device can be used to build a complete IR receiver analog front end (AFE). The nanoamp quiescent current and low input bias current make it possible to be powered with a coin cell battery, which could last for years.



Copyright © 2017, Texas Instruments Incorporated

Figure 42. IR Receiver Analog Front End Using TLV7011

#### 9.2.2.1 Design Requirements

For this design, follow these design requirements:

- Use a proper resistor ( $R_1$ ) value to generate an adequate signal amplitude applied to the inverting input of the comparator.
- The low input bias current  $I_B$  (2 pA typical) ensures that a greater value of  $R_1$  to be used.

### Typical Applications (continued)

- The RC constant value ( $R_2$  and  $C_1$ ) must support the targeted data rate (that is, 9,600 bauds) to maintain a valid tripping threshold.
- The hysteresis introduced with  $R_3$  and  $R_4$  helps to avoid spurious output toggles.

#### 9.2.2.2 Detailed Design Procedure

The IR receiver AFE design is highly streamlined and optimized.  $R_1$  converts the IR light energy induced current into voltage and applies to the inverting input of the comparator. Because a reverse biased IR LED is used as the IR receiver, a higher I/V transimpedance gain is required to boost the amplitude of reduced current. A 10M resistor is used as  $R_1$  to support a 1-V, 100-nA transimpedance gain. This is made possible with the picoamps Input bias current  $I_B$  (5pA typical). The RC network of  $R_2$  and  $C_1$  establishes a reference voltage  $V_{ref}$  which tracks the mean amplitude of the IR signal. The RC constant of  $R_2$  and  $C_1$  (about 4.7 ms) is chosen for  $V_{ref}$  to track the received IR current fluctuation but not the actual data bit stream. The noninverting input is connected to  $V_{ref}$  and the output over the  $R_3$  and  $R_4$  resistor network which provides additional hysteresis for improved guard against spurious toggles.

To reduce the current drain from the coin cell battery, data transmission must be short and infrequent.

#### 9.2.2.3 Application Curve

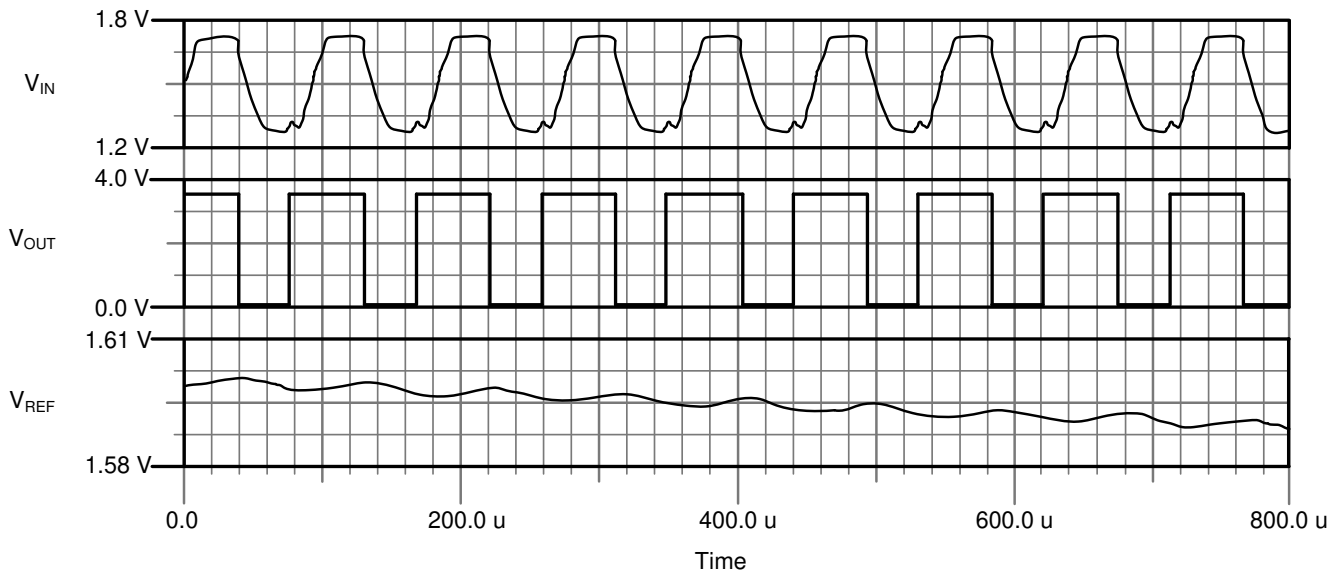

⊗ 43. IR Receiver AFE Waveforms

## Typical Applications (continued)

### 9.2.3 Square-Wave Oscillator

Square-wave oscillator can be used as low cost timing reference or system supervisory clock source.

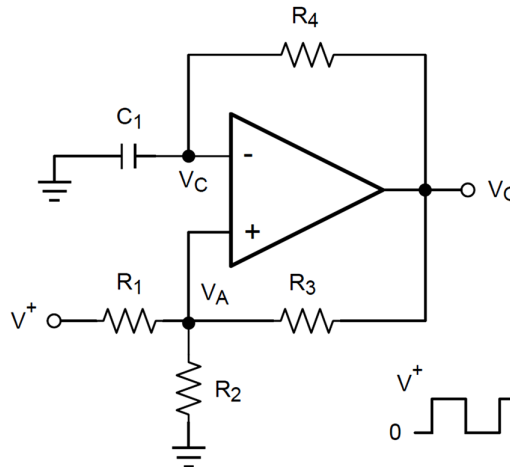

⊗ 44. Square-Wave Oscillator

#### 9.2.3.1 Design Requirements

The square-wave period is determined by the RC time constant of the capacitor and resistor. The maximum frequency is limited by propagation delay of the device and the capacitance load at the output. The low input bias current allows a lower capacitor value and larger resistor value combination for a given oscillator frequency, which may help to reduce BOM cost and board space.

#### 9.2.3.2 Detailed Design Procedure

The oscillation frequency is determined by the resistor and capacitor values. The following calculation provides details of the steps.

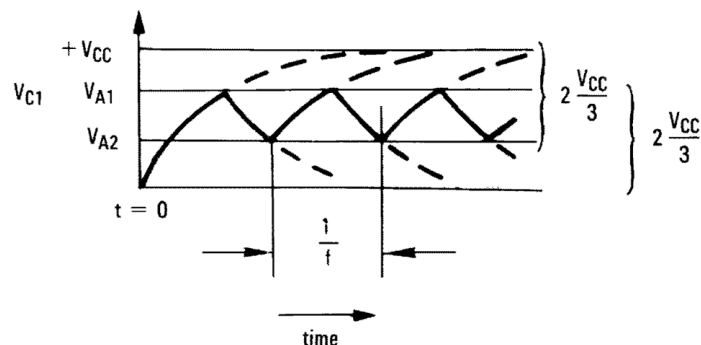

⊗ 45. Square-Wave Oscillator Timing Thresholds

First consider the output of Figure ⊗ 44 is high which indicates the inverted input  $V_C$  is lower than the noninverting input ( $V_A$ ). This causes the  $C_1$  to be charged through  $R_4$ , and the voltage  $V_C$  increases until it is equal to the noninverting input. The value of  $V_A$  at the point is calculated by 式 7.

$$V_{A1} = \frac{V_{CC} \times R_2}{R_2 + R_1 \parallel R_3} \quad (7)$$

if  $R_1 = R_2 = R_3$ , then  $V_{A1} = 2 V_{CC} / 3$



### Typical Applications (continued)

At this time the comparator output trips pulling down the output to the negative rail. The value of  $V_A$  at this point is calculated by 式 8.

$$V_{A2} = \frac{V_{CC}(R_2 I R_3)}{R_1 + R_2 I R_3} \tag{8}$$

if  $R_1 = R_2 = R_3$ , then  $V_{A2} = V_{CC}/3$

The  $C_1$  now discharges though the  $R_4$ , and the voltage  $V_{CC}$  decreases until it reaches  $V_{A2}$ . At this point, the output switches back to the starting state. The oscillation period equals to the time duration from for  $C_1$  from  $2V_{CC}/3$  to  $V_{CC} / 3$  then back to  $2V_{CC}/3$ , which is given by  $R_4 C_1 \times \ln 2$  fro each trip. Therefore, the total time duration is calculated as  $2 R_4 C_1 \times \ln 2$ . The oscillation frequency can be obtained by 式 9:

$$f = 1 / (2 R_4 \times C_1 \times \ln 2) \tag{9}$$

#### 9.2.3.3 Application Curve

Figure 46 shows the simulated results of tan oscillator using the following component values:

- $R_1 = R_2 = R_3 = R_4 = 100 \text{ k}\Omega$
- $C_1 = 100 \text{ pF}$ ,  $C_L = 20 \text{ pF}$
- $V+ = 5 \text{ V}$ ,  $V- = \text{GND}$
- $C_{\text{stray}}$  (not shown) from  $V_A$  TO GND =  $10 \text{ pF}$

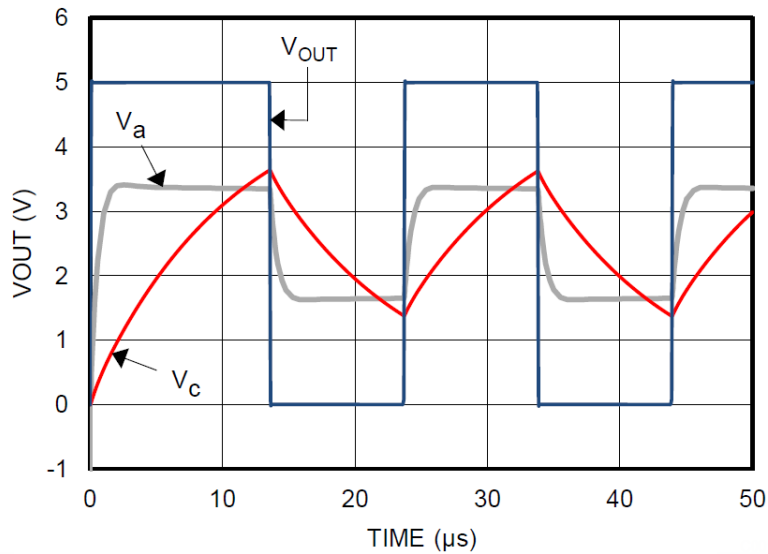

Figure 46. Square-Wave Oscillator Output Waveform

## 10 Power Supply Recommendations

The TLV701x and TLV702x have a recommended operating voltage range ( $V_S$ ) of 1.6 V to 5.5 / 6.5 V.  $V_S$  is defined as  $V_{CC} - V_{EE}$ . Therefore, the supply voltages used to create  $V_S$  can be single-ended or bipolar. For example, single-ended supply voltages of 5 V and 0 V and bipolar supply voltages of +2.5 V and -2.5 V create comparable operating voltages for  $V_S$ . However, when bipolar supply voltages are used, it is important to realize that the logic low level of the comparator output is referenced to  $V_{EE}$ .

Output capacitive loading and output toggle rate will cause the average supply current to rise over the quiescent current.

## 11 Layout

### 11.1 Layout Guidelines

To reduce PCB fabrication cost and improve reliability, TI recommends using a 4-mil via at the center pad connected to the ground trace or plane on the bottom layer.

A power-supply bypass capacitor of 100 nF is recommended when supply output impedance is high, supply traces are long, or when excessive noise is expected on the supply lines. Bypass capacitors are also recommended when the comparator output drives a long trace or is required to drive a capacitive load. Due to the fast rising and falling edge rates and high-output sink and source capability of the TLV7011 and TLV7021 output stages, higher than normal quiescent current can be drawn from the power supply. Under this circumstance, the system would benefit from a bypass capacitor across the supply pins.

### 11.2 Layout Example

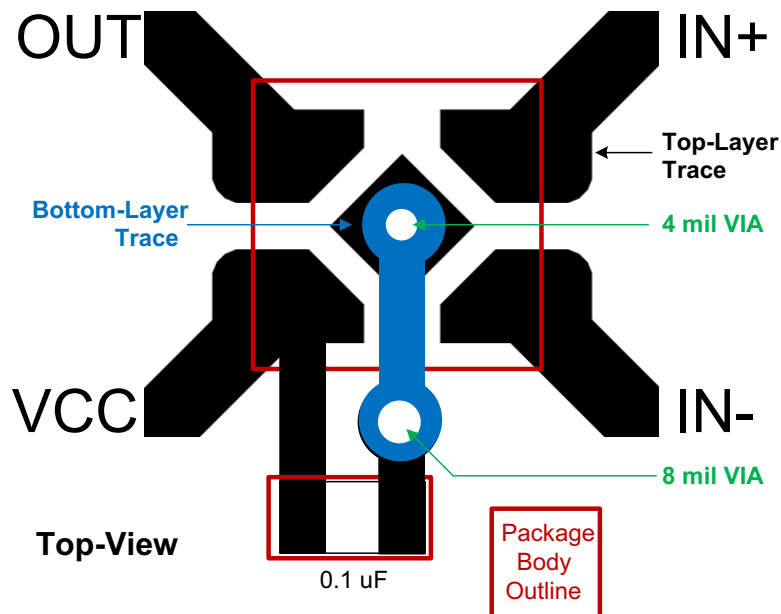

☒ 47. Layout Example

## 12 デバイスおよびドキュメントのサポート

### 12.1 デバイス・サポート

#### 12.1.1 開発サポート

##### 12.1.1.1 評価基板

TLV70x1デバイス・ファミリーを使用する回路の初期性能評価に役立てるため、評価基板(EVM)を利用可能です。[TLV7011 Micro-PowerコンパレータDIPアダプタ評価基板](#)は、テキサス・インスツルメンツWebサイトの製品フォルダで請求でき、TI eStoreから直接お求めにもなれます。

### 12.2 関連リンク

次の表に、クイック・アクセス・リンクを示します。カテゴリには、技術資料、サポートおよびコミュニティ・リソース、ツールとソフトウェア、およびサンプル注文またはご購入へのクイック・アクセスが含まれます。

表 1. 関連リンク

製品	プロダクト・フォルダ	サンプルとご購入	技術資料	ツールとソフトウェア	サポートとコミュニティ
TLV7011	<a href="#">ここをクリック</a>	<a href="#">ここをクリック</a>	<a href="#">ここをクリック</a>	<a href="#">ここをクリック</a>	<a href="#">ここをクリック</a>
TLV7021	<a href="#">ここをクリック</a>	<a href="#">ここをクリック</a>	<a href="#">ここをクリック</a>	<a href="#">ここをクリック</a>	<a href="#">ここをクリック</a>

### 12.3 ドキュメントの更新通知を受け取る方法

ドキュメントの更新についての通知を受け取るには、[ti.com](#)のデバイス製品フォルダを開いてください。右上の「アラートを受け取る」をクリックして登録すると、変更されたすべての製品情報に関するダイジェストを毎週受け取れます。変更の詳細については、修正されたドキュメントに含まれている改訂履歴をご覧ください。

### 12.4 コミュニティ・リソース

[TI E2E™ support forums](#) are an engineer's go-to source for fast, verified answers and design help — straight from the experts. Search existing answers or ask your own question to get the quick design help you need.

Linked content is provided "AS IS" by the respective contributors. They do not constitute TI specifications and do not necessarily reflect TI's views; see TI's [Terms of Use](#).

### 12.5 商標

E2E is a trademark of Texas Instruments.

All other trademarks are the property of their respective owners.

### 12.6 静電気放電に関する注意事項



すべての集積回路は、適切なESD保護方法を用いて、取扱いと保存を行うようにして下さい。

静電気放電はわずかな性能の低下から完全なデバイスの故障に至るまで、様々な損傷を与えます。高精度の集積回路は、損傷に対して敏感であり、極めてわずかなパラメータの変化により、デバイスに規定された仕様に適合しなくなる場合があります。

### 12.7 Glossary

[SLYZ022](#) — *TI Glossary*.

This glossary lists and explains terms, acronyms, and definitions.

## 13 メカニカル、パッケージ、および注文情報

以降のページには、メカニカル、パッケージ、および注文に関する情報が記載されています。この情報は、そのデバイスについて利用可能な最新のデータです。このデータは予告なく変更されることがあり、ドキュメントが改訂される場合もあります。本データシートのブラウザ版を使用されている場合は、画面左側の説明をご覧ください。

**PACKAGING INFORMATION**

Orderable Device	Status (1)	Package Type	Package Drawing	Pins	Package Qty	Eco Plan (2)	Lead finish/ Ball material (6)	MSL Peak Temp (3)	Op Temp (°C)	Device Marking (4/5)	Samples
TLV7011DBVR	ACTIVE	SOT-23	DBV	5	3000	RoHS & Green	NIPDAU   SN   NIPDAUAG	Level-1-260C-UNLIM	-40 to 125	11C2	<a href="#">Samples</a>
TLV7011DCKR	ACTIVE	SC70	DCK	5	3000	RoHS & Green	NIPDAU	Level-2-260C-1 YEAR	-40 to 125	19N	<a href="#">Samples</a>
TLV7011DCKT	ACTIVE	SC70	DCK	5	250	RoHS & Green	NIPDAU	Level-2-260C-1 YEAR	-40 to 125	19N	<a href="#">Samples</a>
TLV7011DPWR	ACTIVE	X2SON	DPW	5	3000	RoHS & Green	NIPDAU	Level-1-260C-UNLIM	-40 to 125	7N	<a href="#">Samples</a>
TLV7012DDFR	ACTIVE	SOT-23-THIN	DDF	8	3000	RoHS & Green	NIPDAU	Level-1-260C-UNLIM	-40 to 125	7012	<a href="#">Samples</a>
TLV7012DGKR	ACTIVE	VSSOP	DGK	8	2500	RoHS & Green	NIPDAU   SN   NIPDAUAG	Level-1-260C-UNLIM	-40 to 125	7012	<a href="#">Samples</a>
TLV7012DSGR	ACTIVE	WSON	DSG	8	3000	RoHS & Green	NIPDAU	Level-1-260C-UNLIM	-40 to 125	7012	<a href="#">Samples</a>
TLV7021DBVR	ACTIVE	SOT-23	DBV	5	3000	RoHS & Green	NIPDAU   SN   NIPDAUAG	Level-1-260C-UNLIM	-40 to 125	11D2	<a href="#">Samples</a>
TLV7021DCKR	ACTIVE	SC70	DCK	5	3000	RoHS & Green	NIPDAU   SN	Level-2-260C-1 YEAR	-40 to 125	19O	<a href="#">Samples</a>
TLV7021DCKT	ACTIVE	SC70	DCK	5	250	RoHS & Green	NIPDAU   SN	Level-2-260C-1 YEAR	-40 to 125	19O	<a href="#">Samples</a>
TLV7021DPWR	ACTIVE	X2SON	DPW	5	3000	RoHS & Green	NIPDAU	Level-1-260C-UNLIM	-40 to 125	7P	<a href="#">Samples</a>
TLV7022DDFR	ACTIVE	SOT-23-THIN	DDF	8	3000	RoHS & Green	NIPDAU	Level-1-260C-UNLIM	-40 to 125	7022	<a href="#">Samples</a>
TLV7022DGKR	ACTIVE	VSSOP	DGK	8	2500	RoHS & Green	NIPDAU   SN   NIPDAUAG	Level-1-260C-UNLIM	-40 to 125	7022	<a href="#">Samples</a>
TLV7022DSGR	ACTIVE	WSON	DSG	8	3000	RoHS & Green	NIPDAU	Level-1-260C-UNLIM	-40 to 125	7022	<a href="#">Samples</a>

(1) The marketing status values are defined as follows:

**ACTIVE:** Product device recommended for new designs.

**LIFEBUY:** TI has announced that the device will be discontinued, and a lifetime-buy period is in effect.

**NRND:** Not recommended for new designs. Device is in production to support existing customers, but TI does not recommend using this part in a new design.

**PREVIEW:** Device has been announced but is not in production. Samples may or may not be available.

**OBSOLETE:** TI has discontinued the production of the device.

(2) **RoHS:** TI defines "RoHS" to mean semiconductor products that are compliant with the current EU RoHS requirements for all 10 RoHS substances, including the requirement that RoHS substance do not exceed 0.1% by weight in homogeneous materials. Where designed to be soldered at high temperatures, "RoHS" products are suitable for use in specified lead-free processes. TI may reference these types of products as "Pb-Free".

**RoHS Exempt:** TI defines "RoHS Exempt" to mean products that contain lead but are compliant with EU RoHS pursuant to a specific EU RoHS exemption.

**Green:** TI defines "Green" to mean the content of Chlorine (Cl) and Bromine (Br) based flame retardants meet JS709B low halogen requirements of  $\leq 1000$ ppm threshold. Antimony trioxide based flame retardants must also meet the  $\leq 1000$ ppm threshold requirement.

(3) MSL, Peak Temp. - The Moisture Sensitivity Level rating according to the JEDEC industry standard classifications, and peak solder temperature.

(4) There may be additional marking, which relates to the logo, the lot trace code information, or the environmental category on the device.

(5) Multiple Device Markings will be inside parentheses. Only one Device Marking contained in parentheses and separated by a "~" will appear on a device. If a line is indented then it is a continuation of the previous line and the two combined represent the entire Device Marking for that device.

(6) Lead finish/Ball material - Orderable Devices may have multiple material finish options. Finish options are separated by a vertical ruled line. Lead finish/Ball material values may wrap to two lines if the finish value exceeds the maximum column width.

**Important Information and Disclaimer:** The information provided on this page represents TI's knowledge and belief as of the date that it is provided. TI bases its knowledge and belief on information provided by third parties, and makes no representation or warranty as to the accuracy of such information. Efforts are underway to better integrate information from third parties. TI has taken and continues to take reasonable steps to provide representative and accurate information but may not have conducted destructive testing or chemical analysis on incoming materials and chemicals. TI and TI suppliers consider certain information to be proprietary, and thus CAS numbers and other limited information may not be available for release.

In no event shall TI's liability arising out of such information exceed the total purchase price of the TI part(s) at issue in this document sold by TI to Customer on an annual basis.

**TAPE AND REEL INFORMATION**

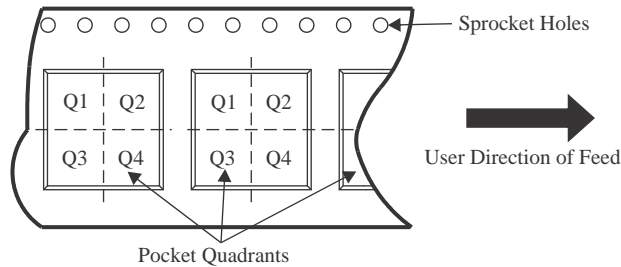
**QUADRANT ASSIGNMENTS FOR PIN 1 ORIENTATION IN TAPE**

\*All dimensions are nominal

Device	Package Type	Package Drawing	Pins	SPQ	Reel Diameter (mm)	Reel Width W1 (mm)	A0 (mm)	B0 (mm)	K0 (mm)	P1 (mm)	W (mm)	Pin1 Quadrant
TLV7011DBVR	SOT-23	DBV	5	3000	180.0	8.4	3.2	3.2	1.4	4.0	8.0	Q3
TLV7011DBVR	SOT-23	DBV	5	3000	180.0	8.4	3.2	3.2	1.4	4.0	8.0	Q3
TLV7011DCKR	SC70	DCK	5	3000	178.0	9.0	2.4	2.5	1.2	4.0	8.0	Q3
TLV7011DCKT	SC70	DCK	5	250	178.0	9.0	2.4	2.5	1.2	4.0	8.0	Q3
TLV7011DPWR	X2SON	DPW	5	3000	178.0	8.4	0.91	0.91	0.5	2.0	8.0	Q2
TLV7012DDFR	SOT-23-THIN	DDF	8	3000	180.0	8.4	3.2	3.2	1.4	4.0	8.0	Q3
TLV7012DGKR	VSSOP	DGK	8	2500	330.0	12.4	5.3	3.4	1.4	8.0	12.0	Q1
TLV7012DSGR	WSOP	DSG	8	3000	180.0	8.4	2.3	2.3	1.15	4.0	8.0	Q2
TLV7021DBVR	SOT-23	DBV	5	3000	180.0	8.4	3.2	3.2	1.4	4.0	8.0	Q3
TLV7021DBVR	SOT-23	DBV	5	3000	180.0	8.4	3.2	3.2	1.4	4.0	8.0	Q3
TLV7021DCKR	SC70	DCK	5	3000	180.0	8.4	2.3	2.5	1.2	4.0	8.0	Q3
TLV7021DCKT	SC70	DCK	5	250	180.0	8.4	2.3	2.5	1.2	4.0	8.0	Q3
TLV7021DPWR	X2SON	DPW	5	3000	178.0	8.4	0.91	0.91	0.5	2.0	8.0	Q2
TLV7022DDFR	SOT-23-THIN	DDF	8	3000	180.0	8.4	3.2	3.2	1.4	4.0	8.0	Q3
TLV7022DGKR	VSSOP	DGK	8	2500	330.0	12.4	5.3	3.4	1.4	8.0	12.0	Q1

Device	Package Type	Package Drawing	Pins	SPQ	Reel Diameter (mm)	Reel Width W1 (mm)	A0 (mm)	B0 (mm)	K0 (mm)	P1 (mm)	W (mm)	Pin1 Quadrant
TLV7022DSGR	WSON	DSG	8	3000	180.0	8.4	2.3	2.3	1.15	4.0	8.0	Q2

**TAPE AND REEL BOX DIMENSIONS**

\*All dimensions are nominal

Device	Package Type	Package Drawing	Pins	SPQ	Length (mm)	Width (mm)	Height (mm)
TLV7011DBVR	SOT-23	DBV	5	3000	210.0	185.0	35.0
TLV7011DBVR	SOT-23	DBV	5	3000	210.0	185.0	35.0
TLV7011DCKR	SC70	DCK	5	3000	190.0	190.0	30.0
TLV7011DCKT	SC70	DCK	5	250	190.0	190.0	30.0
TLV7011DPWR	X2SON	DPW	5	3000	205.0	200.0	33.0
TLV7012DDFR	SOT-23-THIN	DDF	8	3000	210.0	185.0	35.0
TLV7012DGKR	VSSOP	DGK	8	2500	353.0	353.0	32.0
TLV7012DSGR	WSON	DSG	8	3000	210.0	185.0	35.0
TLV7021DBVR	SOT-23	DBV	5	3000	210.0	185.0	35.0
TLV7021DBVR	SOT-23	DBV	5	3000	210.0	185.0	35.0
TLV7021DCKR	SC70	DCK	5	3000	210.0	185.0	35.0
TLV7021DCKT	SC70	DCK	5	250	210.0	185.0	35.0
TLV7021DPWR	X2SON	DPW	5	3000	205.0	200.0	33.0
TLV7022DDFR	SOT-23-THIN	DDF	8	3000	210.0	185.0	35.0
TLV7022DGKR	VSSOP	DGK	8	2500	353.0	353.0	32.0
TLV7022DSGR	WSON	DSG	8	3000	210.0	185.0	35.0





# DBV0005A

## PACKAGE OUTLINE

### SOT-23 - 1.45 mm max height

SMALL OUTLINE TRANSISTOR

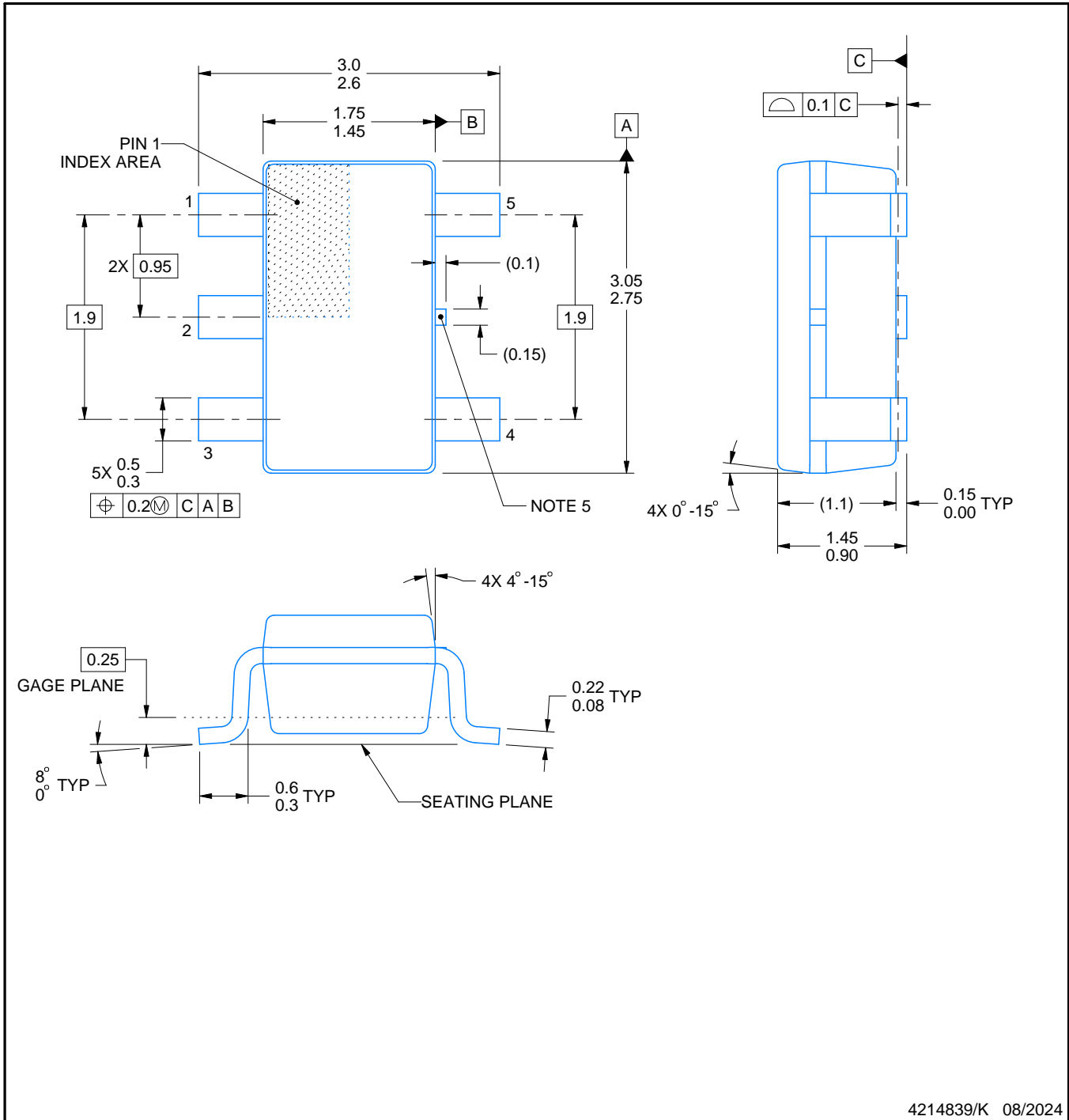

#### NOTES:

1. All linear dimensions are in millimeters. Any dimensions in parenthesis are for reference only. Dimensioning and tolerancing per ASME Y14.5M.
2. This drawing is subject to change without notice.
3. Reference JEDEC MO-178.
4. Body dimensions do not include mold flash, protrusions, or gate burrs. Mold flash, protrusions, or gate burrs shall not exceed 0.25 mm per side.
5. Support pin may differ or may not be present.

# EXAMPLE BOARD LAYOUT

DBV0005A

SOT-23 - 1.45 mm max height

SMALL OUTLINE TRANSISTOR



LAND PATTERN EXAMPLE  
EXPOSED METAL SHOWN  
SCALE:15X



SOLDER MASK DETAILS

4214839/K 08/2024

NOTES: (continued)

- 6. Publication IPC-7351 may have alternate designs.
- 7. Solder mask tolerances between and around signal pads can vary based on board fabrication site.

# EXAMPLE STENCIL DESIGN

DBV0005A

SOT-23 - 1.45 mm max height

SMALL OUTLINE TRANSISTOR



SOLDER PASTE EXAMPLE  
BASED ON 0.125 mm THICK STENCIL  
SCALE:15X

4214839/K 08/2024

NOTES: (continued)

8. Laser cutting apertures with trapezoidal walls and rounded corners may offer better paste release. IPC-7525 may have alternate design recommendations.
9. Board assembly site may have different recommendations for stencil design.

# DGK0008A



# PACKAGE OUTLINE

VSSOP - 1.1 mm max height

SMALL OUTLINE PACKAGE



**NOTES:**

PowerPAD is a trademark of Texas Instruments.

1. All linear dimensions are in millimeters. Any dimensions in parenthesis are for reference only. Dimensioning and tolerancing per ASME Y14.5M.
2. This drawing is subject to change without notice.
3. This dimension does not include mold flash, protrusions, or gate burrs. Mold flash, protrusions, or gate burrs shall not exceed 0.15 mm per side.
4. This dimension does not include interlead flash. Interlead flash shall not exceed 0.25 mm per side.
5. Reference JEDEC registration MO-187.

# EXAMPLE BOARD LAYOUT

DGK0008A

™ VSSOP - 1.1 mm max height

SMALL OUTLINE PACKAGE



LAND PATTERN EXAMPLE  
EXPOSED METAL SHOWN  
SCALE: 15X



4214862/A 04/2023

NOTES: (continued)

6. Publication IPC-7351 may have alternate designs.
7. Solder mask tolerances between and around signal pads can vary based on board fabrication site.
8. Vias are optional depending on application, refer to device data sheet. If any vias are implemented, refer to their locations shown on this view. It is recommended that vias under paste be filled, plugged or tented.
9. Size of metal pad may vary due to creepage requirement.

# EXAMPLE STENCIL DESIGN

DGK0008A

<sup>TM</sup> VSSOP - 1.1 mm max height

SMALL OUTLINE PACKAGE



SOLDER PASTE EXAMPLE  
SCALE: 15X

4214862/A 04/2023

NOTES: (continued)

11. Laser cutting apertures with trapezoidal walls and rounded corners may offer better paste release. IPC-7525 may have alternate design recommendations.
12. Board assembly site may have different recommendations for stencil design.

## GENERIC PACKAGE VIEW

DPW 5

X2SON - 0.4 mm max height

PLASTIC SMALL OUTLINE - NO LEAD



Images above are just a representation of the package family, actual package may vary.  
Refer to the product data sheet for package details.

4211218-3/D

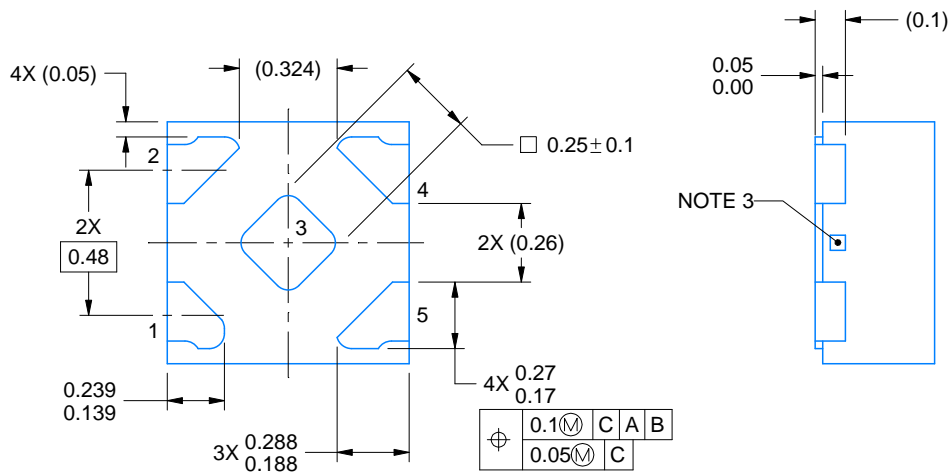
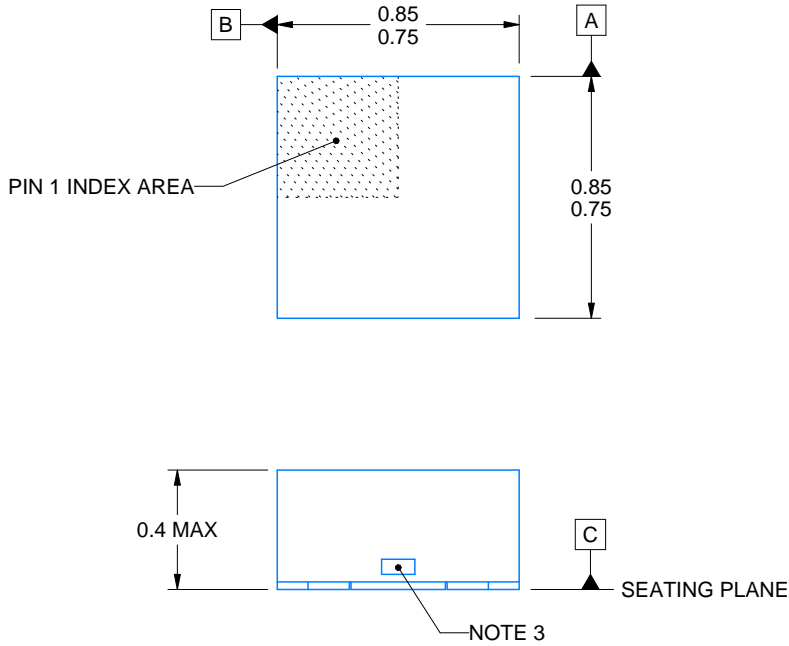

4223102/D 03/2022

NOTES:

1. All linear dimensions are in millimeters. Any dimensions in parenthesis are for reference only. Dimensioning and tolerancing per ASME Y14.5M.
2. This drawing is subject to change without notice.
3. The size and shape of this feature may vary.



# EXAMPLE BOARD LAYOUT

DPW0005A

X2SON - 0.4 mm max height

PLASTIC SMALL OUTLINE - NO LEAD

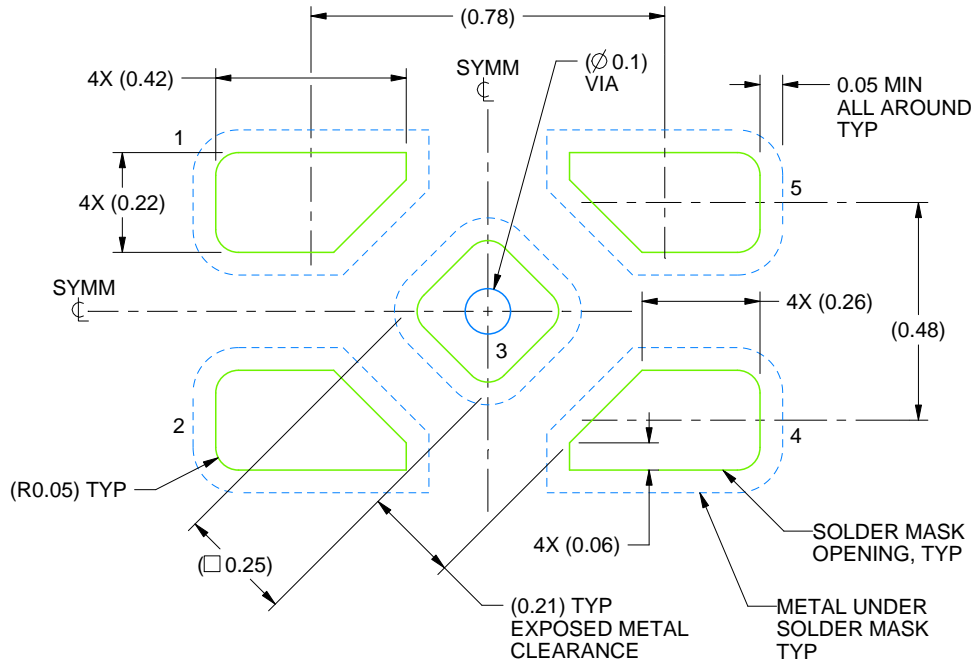

LAND PATTERN EXAMPLE  
SOLDER MASK DEFINED  
SCALE:60X

4223102/D 03/2022

NOTES: (continued)

4. This package is designed to be soldered to a thermal pad on the board. For more information, refer to QFN/SON PCB application note in literature No. SLUA271 ([www.ti.com/lit/slua271](http://www.ti.com/lit/slua271)).

# EXAMPLE STENCIL DESIGN

DPW0005A

X2SON - 0.4 mm max height

PLASTIC SMALL OUTLINE - NO LEAD



SOLDER PASTE EXAMPLE  
BASED ON 0.1 mm THICK STENCIL

EXPOSED PAD 3  
92% PRINTED SOLDER COVERAGE BY AREA UNDER PACKAGE  
SCALE:100X

4223102/D 03/2022

NOTES: (continued)

5. Laser cutting apertures with trapezoidal walls and rounded corners may offer better paste release. IPC-7525 may have alternate design recommendations.

# DDF0008A



# PACKAGE OUTLINE

## SOT-23-THIN - 1.1 mm max height

PLASTIC SMALL OUTLINE



4222047/E 07/2024

### NOTES:

1. All linear dimensions are in millimeters. Any dimensions in parenthesis are for reference only. Dimensioning and tolerancing per ASME Y14.5M.
2. This drawing is subject to change without notice.
3. This dimension does not include mold flash, protrusions, or gate burrs. Mold flash, protrusions, or gate burrs shall not exceed 0.15 mm per side.

# EXAMPLE BOARD LAYOUT

DDF0008A

SOT-23-THIN - 1.1 mm max height

PLASTIC SMALL OUTLINE

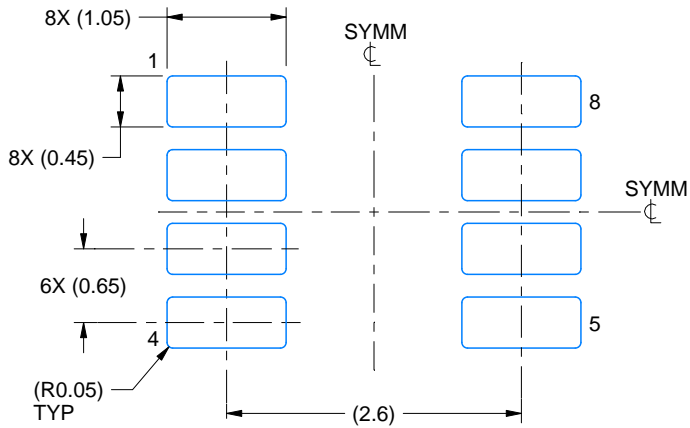

LAND PATTERN EXAMPLE  
EXPOSED METAL SHOWN  
SCALE:15X

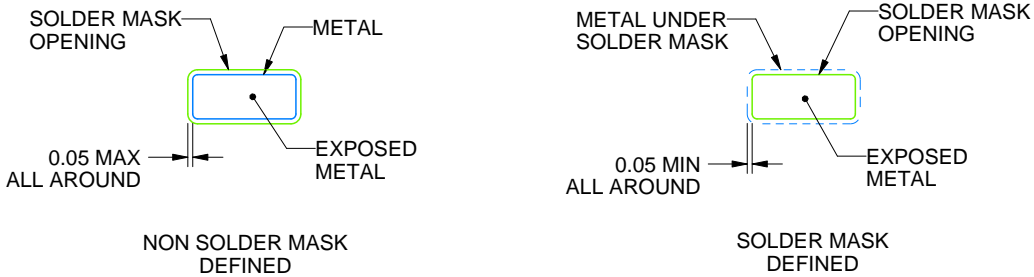

SOLDER MASK DETAILS

4222047/E 07/2024

NOTES: (continued)

- 4. Publication IPC-7351 may have alternate designs.
- 5. Solder mask tolerances between and around signal pads can vary based on board fabrication site.

# EXAMPLE STENCIL DESIGN

DDF0008A

SOT-23-THIN - 1.1 mm max height

PLASTIC SMALL OUTLINE



SOLDER PASTE EXAMPLE  
BASED ON 0.125 mm THICK STENCIL  
SCALE:15X

4222047/E 07/2024

NOTES: (continued)

6. Laser cutting apertures with trapezoidal walls and rounded corners may offer better paste release. IPC-7525 may have alternate design recommendations.
7. Board assembly site may have different recommendations for stencil design.

# DCK0005A



# PACKAGE OUTLINE

SOT - 1.1 max height

SMALL OUTLINE TRANSISTOR

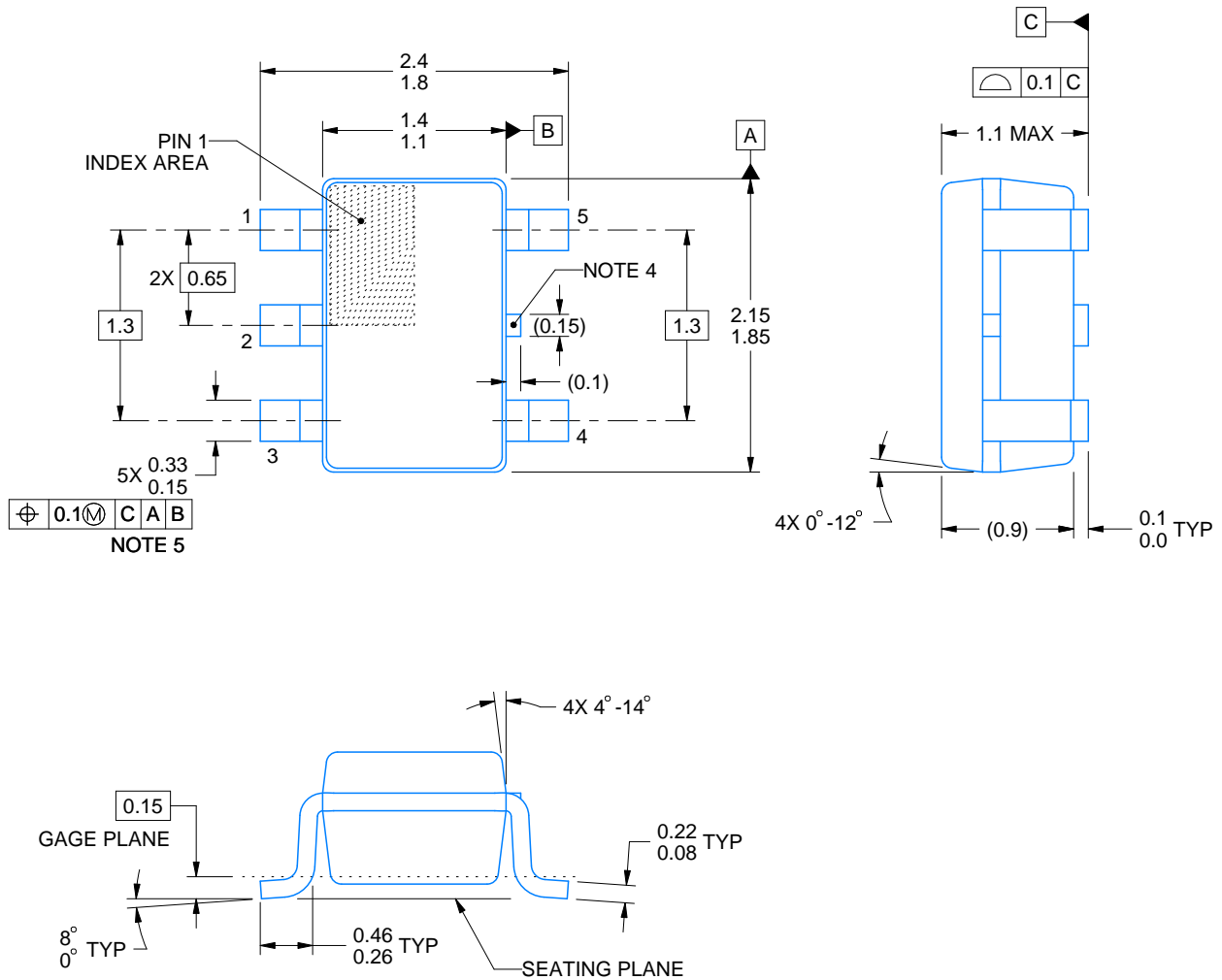

4214834/F 08/2024

## NOTES:

1. All linear dimensions are in millimeters. Any dimensions in parenthesis are for reference only. Dimensioning and tolerancing per ASME Y14.5M.
2. This drawing is subject to change without notice.
3. Reference JEDEC MO-203.
4. Support pin may differ or may not be present.
5. Lead width does not comply with JEDEC.
6. Body dimensions do not include mold flash, protrusions, or gate burrs. Mold flash, protrusions, or gate burrs shall not exceed 0.25mm per side

# EXAMPLE BOARD LAYOUT

DCK0005A

SOT - 1.1 max height

SMALL OUTLINE TRANSISTOR



LAND PATTERN EXAMPLE  
EXPOSED METAL SHOWN  
SCALE:18X

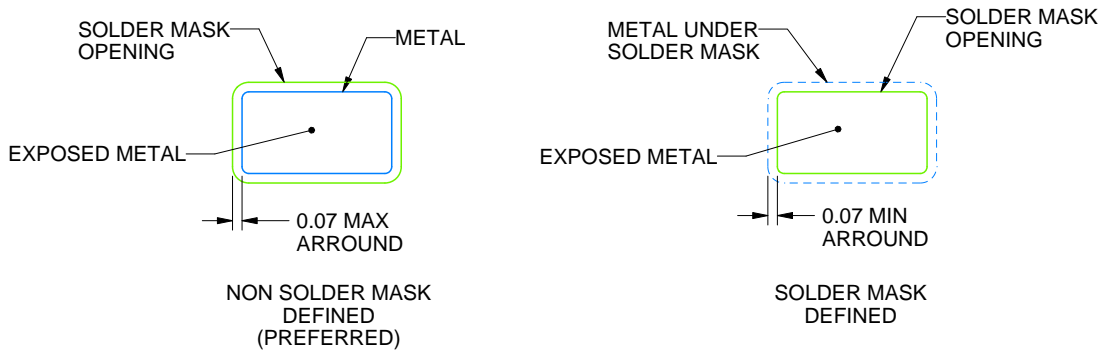

SOLDER MASK DETAILS

4214834/F 08/2024

NOTES: (continued)

- 7. Publication IPC-7351 may have alternate designs.
- 8. Solder mask tolerances between and around signal pads can vary based on board fabrication site.

# EXAMPLE STENCIL DESIGN

DCK0005A

SOT - 1.1 max height

SMALL OUTLINE TRANSISTOR

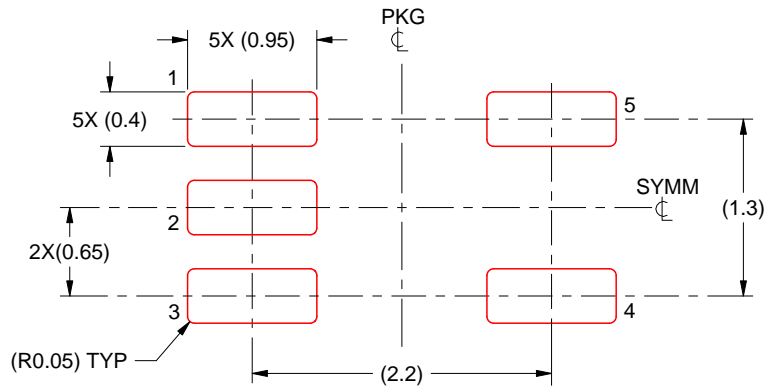

SOLDER PASTE EXAMPLE  
BASED ON 0.125 THICK STENCIL  
SCALE: 18X

4214834/F 08/2024

NOTES: (continued)

9. Laser cutting apertures with trapezoidal walls and rounded corners may offer better paste release. IPC-7525 may have alternate design recommendations.
10. Board assembly site may have different recommendations for stencil design.



## GENERIC PACKAGE VIEW

**DSG 8**

**WSON - 0.8 mm max height**

2 x 2, 0.5 mm pitch

PLASTIC SMALL OUTLINE - NO LEAD

This image is a representation of the package family, actual package may vary.  
Refer to the product data sheet for package details.



4224783/A

# DSG0008A



# PACKAGE OUTLINE

## WSON - 0.8 mm max height

PLASTIC SMALL OUTLINE - NO LEAD

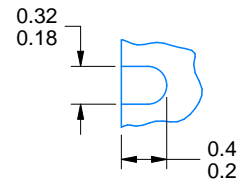

ALTERNATIVE TERMINAL SHAPE TYPICAL



SIDE WALL METAL THICKNESS DIM A	
OPTION 1	OPTION 2
0.1	0.2

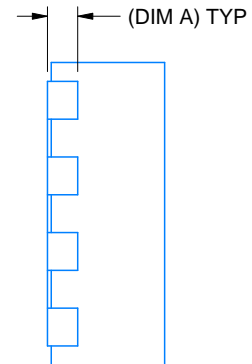

4218900/E 08/2022

### NOTES:

1. All linear dimensions are in millimeters. Any dimensions in parenthesis are for reference only. Dimensioning and tolerancing per ASME Y14.5M.
2. This drawing is subject to change without notice.
3. The package thermal pad must be soldered to the printed circuit board for thermal and mechanical performance.

# EXAMPLE BOARD LAYOUT

DSG0008A

WSON - 0.8 mm max height

PLASTIC SMALL OUTLINE - NO LEAD



LAND PATTERN EXAMPLE  
SCALE:20X

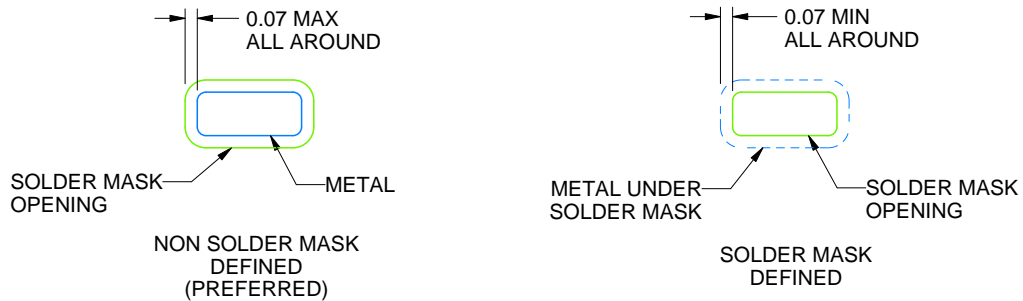

SOLDER MASK DETAILS

4218900/E 08/2022

NOTES: (continued)

4. This package is designed to be soldered to a thermal pad on the board. For more information, see Texas Instruments literature number SLUA271 ([www.ti.com/lit/slua271](http://www.ti.com/lit/slua271)).
5. Vias are optional depending on application, refer to device data sheet. If any vias are implemented, refer to their locations shown on this view. It is recommended that vias under paste be filled, plugged or tented.

# EXAMPLE STENCIL DESIGN

DSG0008A

WSON - 0.8 mm max height

PLASTIC SMALL OUTLINE - NO LEAD



SOLDER PASTE EXAMPLE  
BASED ON 0.125 mm THICK STENCIL

EXPOSED PAD 9:  
87% PRINTED SOLDER COVERAGE BY AREA UNDER PACKAGE  
SCALE:25X

4218900/E 08/2022

NOTES: (continued)

6. Laser cutting apertures with trapezoidal walls and rounded corners may offer better paste release. IPC-7525 may have alternate design recommendations.

## 重要なお知らせと免責事項

TI は、技術データと信頼性データ (データシートを含みます)、設計リソース (リファレンス・デザインを含みます)、アプリケーションや設計に関する各種アドバイス、Web ツール、安全性情報、その他のリソースを、欠陥が存在する可能性のある「現状のまま」提供しており、商品性および特定目的に対する適合性の黙示保証、第三者の知的財産権の非侵害保証を含むいかなる保証も、明示的または黙示的にかかわらず拒否します。

これらのリソースは、TI 製品を使用する設計の経験を積んだ開発者への提供を意図したものです。(1) お客様のアプリケーションに適した TI 製品の選定、(2) お客様のアプリケーションの設計、検証、試験、(3) お客様のアプリケーションに該当する各種規格や、その他のあらゆる安全性、セキュリティ、規制、または他の要件への確実な適合に関する責任を、お客様のみが単独で負うものとし、

上記の各種リソースは、予告なく変更される可能性があります。これらのリソースは、リソースで説明されている TI 製品を使用するアプリケーションの開発の目的でのみ、TI はその使用をお客様に許諾します。これらのリソースに関して、他の目的で複製することや掲載することは禁止されています。TI や第三者の知的財産権のライセンスが付与されている訳ではありません。お客様は、これらのリソースを自身で使用した結果発生するあらゆる申し立て、損害、費用、損失、責任について、TI およびその代理人を完全に補償するものとし、TI は一切の責任を拒否します。

TI の製品は、[TI の販売条件](#)、または [ti.com](#) やかかる TI 製品の関連資料などのいずれかを通じて提供する適用可能な条項の下で提供されています。TI がこれらのリソースを提供することは、適用される TI の保証または他の保証の放棄の拡大や変更を意味するものではありません。

お客様がいかなる追加条項または代替条項を提案した場合でも、TI はそれらに異議を唱え、拒否します。

郵送先住所 : Texas Instruments, Post Office Box 655303, Dallas, Texas 75265  
Copyright © 2024, Texas Instruments Incorporated