

# TLV700xx-Q1 車載用 300mA、低 $I_Q$ 、低ドロップアウトレギュレータ

## 1 特長

- 車載アプリケーション用に AEC-Q100 認定済み:
  - デバイス温度グレード 1: 動作時周囲温度範囲  $-40^{\circ}\text{C} \sim 125^{\circ}\text{C}$
  - デバイス HBM ESD 分類レベル H2
  - デバイス CDM ESD 分類レベル C3B
- 2% 精度
- 低  $I_Q$ : 35 $\mu\text{A}$
- 固定出力電圧: 1.2V および 1.8V
- 高 PSRR: 1kHz 時に 68dB
- 実効容量 0.1 $\mu\text{F}$ <sup>(1)</sup> で安定
- サーマル シャットダウンおよび過電流保護<sup>1</sup>

## 2 アプリケーション

- 車載ヘッド ユニット
- カメラ センサとモジュール
- ヘッドアップ ディスプレイ (HUD)
- テレマティクス制御ユニット

## 3 概要

TLV70018-Q1 および TLV70012-Q1 の低ドロップアウト (LDO) リニア レギュレータは、低静止電流のデバイスで、ラインおよび負荷過渡性能が非常に優れています。高精度のバンドギャップおよびエラー アンプにより、総合で 2% 精度を実現しています。低出力ノイズ、非常に高い電源電圧変動除去比 (PSRR)、低ドロップアウト電圧を特長とする本シリーズのデバイスは、電力に敏感な負荷に電力を供給するのに最適です。デバイスのすべてのバージョンには、フォルト条件検出のためにサーマル シャットダウン機能と電流制限機能を搭載しています。

さらに、これらのデバイスはわずか 0.1 $\mu\text{F}$  の実効出力容量で安定します。この機能により、バイアス電圧および温度デレーティングの高い、コスト効率の優れたコンデンサを使用できます。これらのデバイスは、出力負荷なしでも指定の精度へのレギュレーションを行います。

### パッケージ情報

部品番号	パッケージ <sup>(1)</sup>	パッケージ サイズ <sup>(2)</sup>
TLV70018-Q1	DDC (SOT, 5)	2.9mm × 2.8mm
TLV70012-Q1		

- 詳細については、[メカニカル](#)、[パッケージ](#)、および[注文情報](#)をご覧ください。
- パッケージ サイズ (長さ×幅) は公称値であり、該当する場合はピンも含まれます。

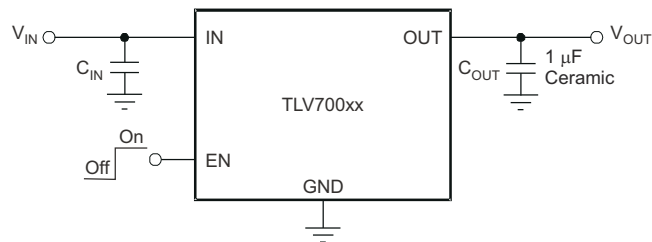

代表的なアプリケーション

<sup>1</sup> については、「[入力および出力コンデンサの要件](#)」をご覧ください。



## Table of Contents

<b>1 特長</b> .....	<b>1</b>	<b>7 Application and Implementation</b> .....	<b>11</b>
<b>2 アプリケーション</b> .....	<b>1</b>	7.1 Application Information.....	11
<b>3 概要</b> .....	<b>1</b>	7.2 Typical Application.....	11
<b>4 Pin Configuration and Functions</b> .....	<b>2</b>	7.3 Power Supply Recommendations.....	12
<b>5 Specifications</b> .....	<b>3</b>	7.4 Layout.....	13
5.1 Absolute Maximum Ratings.....	3	<b>8 Device and Documentation Support</b> .....	<b>15</b>
5.2 ESD Ratings.....	3	8.1 Device Support.....	15
5.3 Recommended Operating Conditions.....	3	8.2 Documentation Support.....	15
5.4 Thermal Information.....	3	8.3 ドキュメントの更新通知を受け取る方法.....	15
5.5 Electrical Characteristics.....	4	8.4 サポート・リソース.....	15
5.6 Typical Characteristics.....	5	8.5 Trademarks.....	15
<b>6 Detailed Description</b> .....	<b>9</b>	8.6 静電気放電に関する注意事項.....	15
6.1 Overview.....	9	8.7 用語集.....	15
6.2 Functional Block Diagram.....	9	<b>9 Revision History</b> .....	<b>16</b>
6.3 Feature Description.....	9	<b>10 Mechanical, Packaging, and Orderable Information</b> .....	<b>16</b>
6.4 Device Functional Modes.....	10		

## 4 Pin Configuration and Functions



図 4-1. DDC Package, 5-Pin SOT (Top View)

表 4-1. Pin Functions

PIN		DESCRIPTION
NO.	NAME	
1	IN	Input pin. A small 1µF ceramic capacitor is recommended from this pin to ground to provide stability and good transient performance. <sup>(1)</sup>
2	GND	Ground pin
3	EN	Enable pin. Driving EN over 0.9V turns on the regulator. Driving EN below 0.4V puts the regulator into shutdown mode and reduces operating current to 1µA, nominal.
4	NC	No connection. This pin can be tied to ground to improve thermal dissipation.
5	OUT	Regulated output voltage pin. A small 1µF ceramic capacitor is needed from this pin to ground to provide stability. <sup>(1)</sup>

(1) See the [Input and Output Capacitor Requirements](#) section for more details.

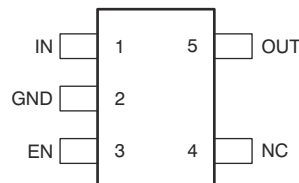
## 5 Specifications

### 5.1 Absolute Maximum Ratings

over operating free-air temperature range, unless otherwise noted<sup>(1)</sup>

			MIN	MAX	UNIT
Voltage <sup>(2)</sup>	IN		-0.3	6.0	V
	EN		-0.3	6.0	V
	OUT		-0.3	6.0	V
Current (source)	OUT		Internally limited		
Output short-circuit duration			Indefinite		
Operating virtual junction, T <sub>J</sub>			-55	150	°C
Storage temperature, T <sub>stg</sub>			-55	150	°C

(1) Stresses beyond those listed under *Absolute Maximum Ratings* may cause permanent damage to the device. These are stress ratings only, which do not imply functional operation of the device at these or any other conditions beyond those indicated under *Recommended Operating Conditions*. Exposure to absolute-maximum-rated conditions for extended periods may affect device reliability.

(2) All voltages are with respect to network ground terminal.

### 5.2 ESD Ratings

			VALUE	UNIT
V <sub>(ESD)</sub>	Electrostatic discharge	Human-body model (HBM), per AEC Q100-002 <sup>(1)</sup>	2000	V
		Charged-device model (CDM), per AEC Q100-011	750	

(1) AEC Q100-002 indicates that HBM stressing shall be in accordance with the ANSI/ESDA/JEDEC JS-001 specification.

### 5.3 Recommended Operating Conditions

over operating free-air temperature range, unless otherwise noted.

			MIN	MAX	UNIT
V <sub>IN</sub>	Input voltage	IN	2	5.5	V
V <sub>EN</sub>	Enable voltage	EN	0	5.5	V
V <sub>OUT</sub>	Output voltage	OUT	0	1.8	V
I <sub>OUT</sub>	Current output		0	300	mA
T <sub>J</sub>	Operating junction temperature		-40	150	°C

### 5.4 Thermal Information

THERMAL METRIC <sup>(1)</sup>		TLV70018-Q1, TLV70012-Q1	UNIT
		DDC (SOT)	
		5 PINS	
R <sub>θJA</sub>	Junction-to-ambient thermal resistance	262.8	°C/W
R <sub>θJC(top)</sub>	Junction-to-case (top) thermal resistance	68.2	°C/W
R <sub>θJB</sub>	Junction-to-board thermal resistance	81.6	°C/W
ψ <sub>JT</sub>	Junction-to-top characterization parameter	1.1	°C/W
ψ <sub>JB</sub>	Junction-to-board characterization parameter	80.9	°C/W
R <sub>θJC(bot)</sub>	Junction-to-case (bottom) thermal resistance	NA	°C/W

(1) For more information about traditional and new thermal metrics, see the [Semiconductor and IC Package Thermal Metrics application note](#).

## 5.5 Electrical Characteristics

at  $V_{IN} = V_{OUT(NOM)} + 0.5V$  or  $2V$  (whichever is greater);  $I_{OUT} = 10mA$ ,  $V_{EN} = 0.9V$ ,  $C_{OUT} = 1.0\mu F$ , and  $T_A = -40^\circ C$  to  $125^\circ C$  (unless otherwise noted); typical values are at  $T_A = 25^\circ C$  (unless otherwise noted)

PARAMETER		TEST CONDITIONS	MIN	TYP	MAX	UNIT
$V_{IN}$	Input voltage range		2		5.5	V
$V_{OUT}$	DC output accuracy	$-40^\circ C \leq T_A \leq 125^\circ C$	-2%	0.5%	2%	
$\Delta V_{OUT}/\Delta V_{IN}$	Line regulation	$V_{OUT(NOM)} + 0.5V \leq V_{IN} \leq 5.5V$ , $I_{OUT} = 10mA$		1	5	mV
$\Delta V_{OUT}/\Delta I_{OUT}$	Load regulation	$0mA \leq I_{OUT} \leq 300mA$ , TLV70018-Q1		1	15	mV
		$0mA \leq I_{OUT} \leq 300mA$ , TLV70012-Q1		1	20	
$I_{CL}$	Output current limit	$V_{OUT} = 0.9 \times V_{OUT(NOM)}$	320	500	860	mA
$I_{GND}$	Ground pin current	$I_{OUT} = 0mA$		35	55	$\mu A$
		$I_{OUT} = 300mA$ , $V_{IN} = V_{OUT} + 0.5V$		370		$\mu A$
$I_{SHDN}$	Ground pin current (shutdown)	$V_{EN} \leq 0.4V$ , $V_{IN} = 2.0V$		400		nA
		$V_{EN} \leq 0.4V$ , $2.0V \leq V_{IN} \leq 4.5V$ , $T_A = -40^\circ C$ to $85^\circ C$		1	2	$\mu A$
		$V_{EN} \leq 0.4V$ , $2.0V \leq V_{IN} \leq 4.5V$ , $T_A = 85^\circ C$ to $125^\circ C$		1	2.5	$\mu A$
PSRR	Power-supply rejection ratio	$V_{IN} = 2.3V$ , $V_{OUT} = 1.8V$ , $I_{OUT} = 10mA$ , $f = 1kHz$		68		dB
$V_n$	Output noise voltage	BW = 100Hz to 100kHz, $V_{IN} = 2.3V$ , $V_{OUT} = 1.8V$ , $I_{OUT} = 10mA$		48		$\mu V_{RMS}$
$t_{STR}$	Startup time <sup>(1)</sup>	$C_{OUT} = 1.0\mu F$ , $I_{OUT} = 300mA$		100		$\mu s$
$V_{EN(HI)}$	Enable pin high (enabled)		0.9		$V_{IN}$	V
$V_{EN(LO)}$	Enable pin low (disabled)		0		0.4	V
$I_{EN}$	Enable pin current	$V_{IN} = V_{EN} = 5.5V$		0.04		$\mu A$
UVLO	Undervoltage lockout	$V_{IN}$ rising		1.9		V
$T_{SD}$	Thermal shutdown temperature	Shutdown, temperature increasing		165		$^\circ C$
		Reset, temperature decreasing		145		$^\circ C$
$T_A$	Operating temperature		-40		125	$^\circ C$

(1) Startup time = time from EN assertion to  $0.98 \times V_{OUT(NOM)}$ .

## 5.6 Typical Characteristics

over operating temperature range ( $T_J = -40^{\circ}\text{C}$  to  $125^{\circ}\text{C}$ ),  $V_{IN} = V_{OUT(NOM)} + 0.5\text{V}$  or  $2\text{V}$ , whichever is greater;  $I_{OUT} = 10\text{mA}$ ,  $V_{EN} = V_{IN}$ ,  $C_{OUT} = 1.0\mu\text{F}$  (unless otherwise noted); typical values are at  $T_J = 25^{\circ}\text{C}$

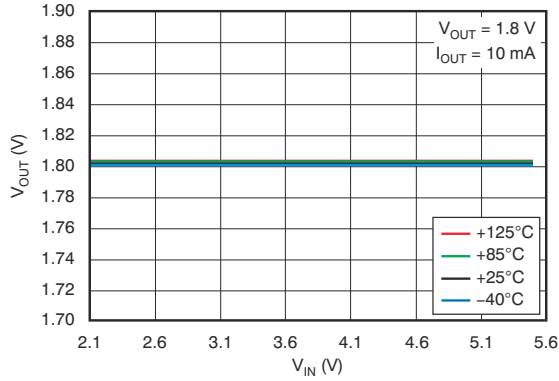

5-1. Line Regulation 10mA

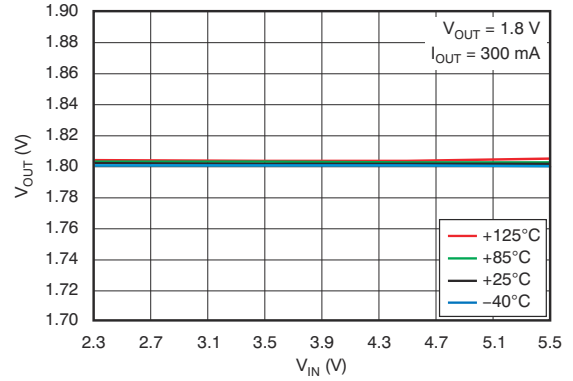

5-2. Line Regulation 300mA

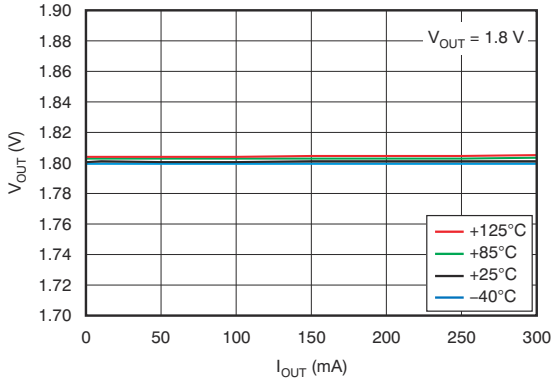

5-3. Load Regulation

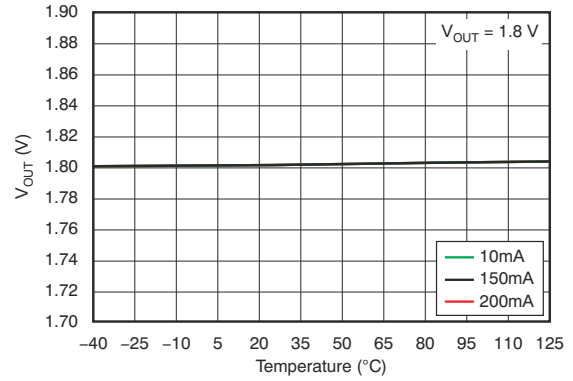

5-4. Output Voltage vs Temperature

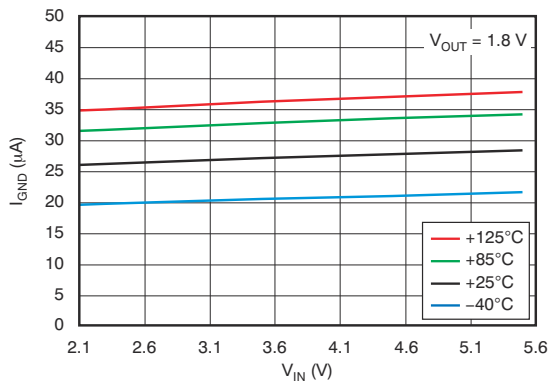

5-5. Ground Pin Current vs Input Voltage

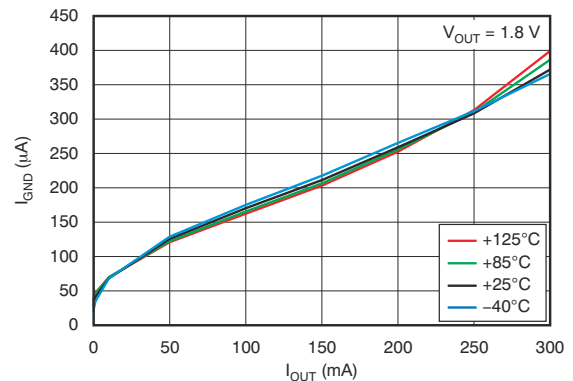

5-6. Ground Pin Current vs Load

### 5.6 Typical Characteristics (continued)

over operating temperature range ( $T_J = -40^{\circ}\text{C}$  to  $125^{\circ}\text{C}$ ),  $V_{IN} = V_{OUT(NOM)} + 0.5\text{V}$  or  $2\text{V}$ , whichever is greater;  $I_{OUT} = 10\text{mA}$ ,  $V_{EN} = V_{IN}$ ,  $C_{OUT} = 1.0\mu\text{F}$  (unless otherwise noted); typical values are at  $T_J = 25^{\circ}\text{C}$

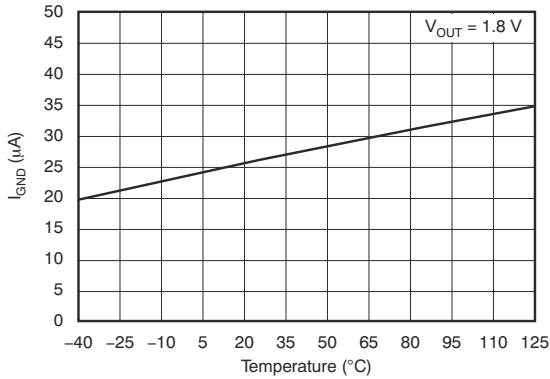

5-7. Ground Pin Current vs Temperature

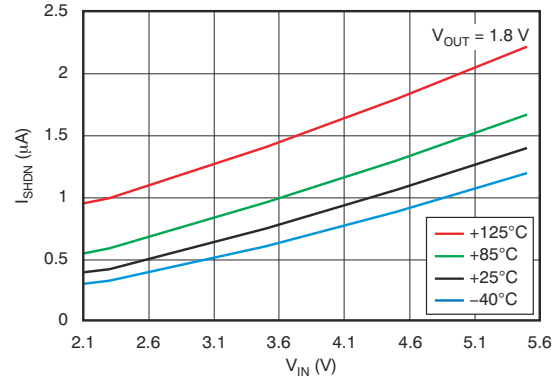

5-8. Shutdown Current vs Input Voltage

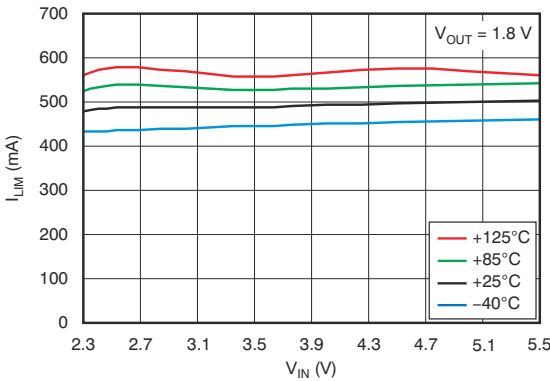

5-9. Current Limit vs Input Voltage

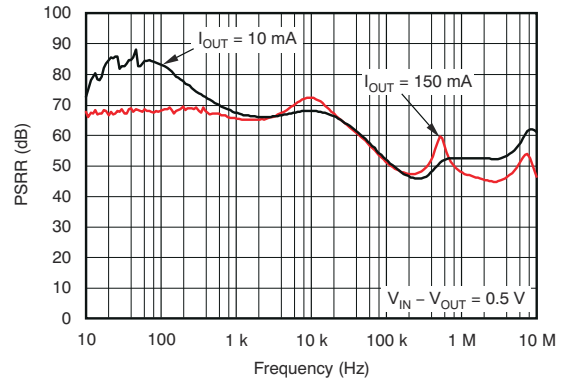

5-10. Power-Supply Ripple Rejection vs Frequency

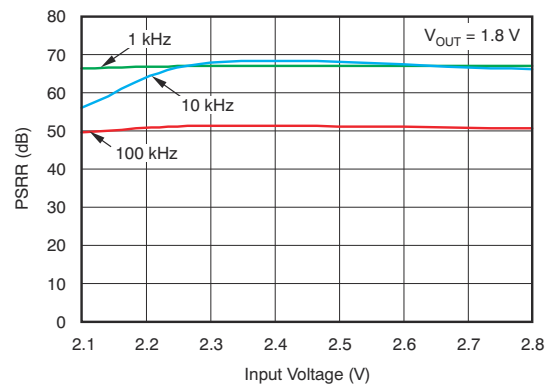

5-11. Power-Supply Ripple Rejection vs Input Voltage

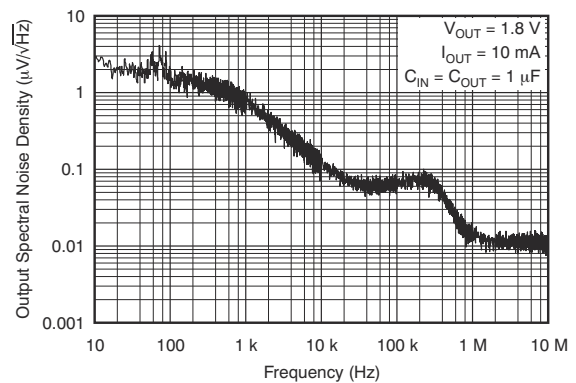

5-12. Output Spectral Noise Density vs Frequency

## 5.6 Typical Characteristics (continued)

over operating temperature range ( $T_J = -40^{\circ}\text{C}$  to  $125^{\circ}\text{C}$ ),  $V_{IN} = V_{OUT(NOM)} + 0.5\text{V}$  or  $2\text{V}$ , whichever is greater;  $I_{OUT} = 10\text{mA}$ ,  $V_{EN} = V_{IN}$ ,  $C_{OUT} = 1.0\mu\text{F}$  (unless otherwise noted); typical values are at  $T_J = 25^{\circ}\text{C}$

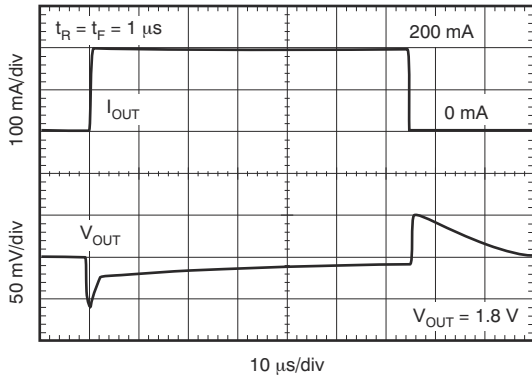

5-13. Load Transient Response

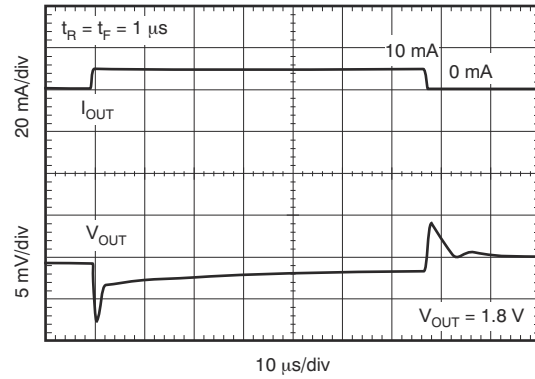

5-14. Load Transient Response

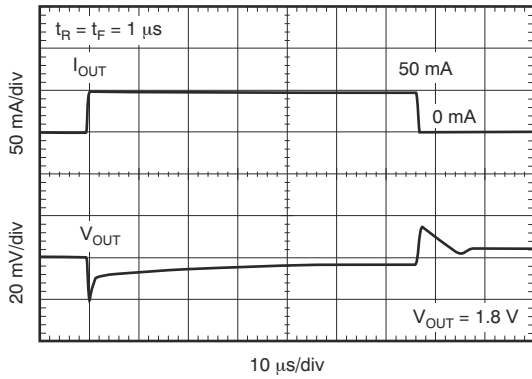

5-15. Load Transient Response

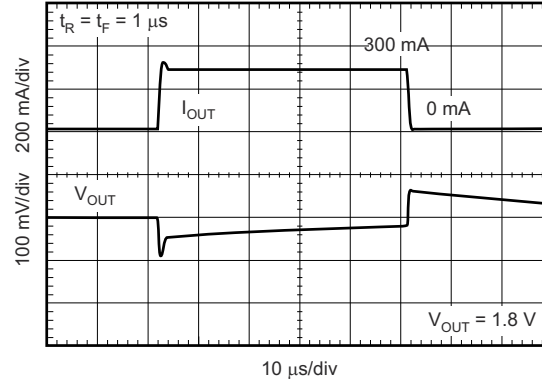

5-16. Load Transient Response

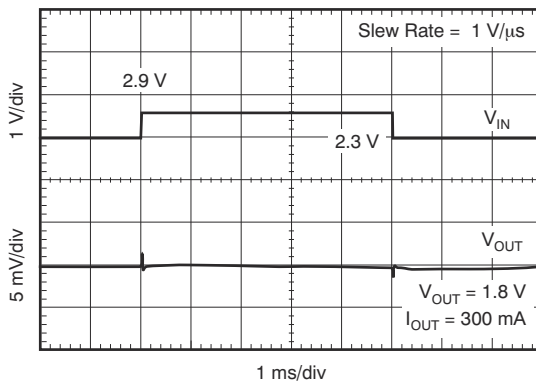

5-17. Line Transient Response

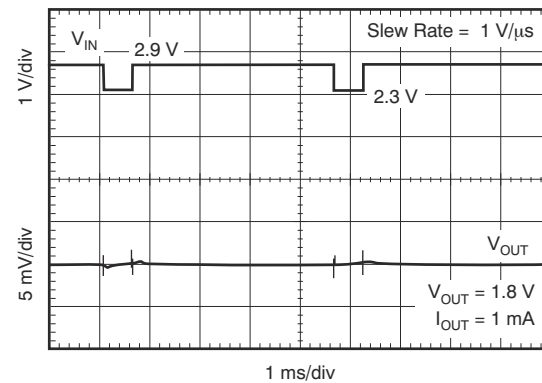

5-18. Line Transient Response

### 5.6 Typical Characteristics (continued)

over operating temperature range ( $T_J = -40^\circ\text{C}$  to  $125^\circ\text{C}$ ),  $V_{IN} = V_{OUT(NOM)} + 0.5\text{V}$  or  $2\text{V}$ , whichever is greater;  $I_{OUT} = 10\text{mA}$ ,  $V_{EN} = V_{IN}$ ,  $C_{OUT} = 1.0\mu\text{F}$  (unless otherwise noted); typical values are at  $T_J = 25^\circ\text{C}$

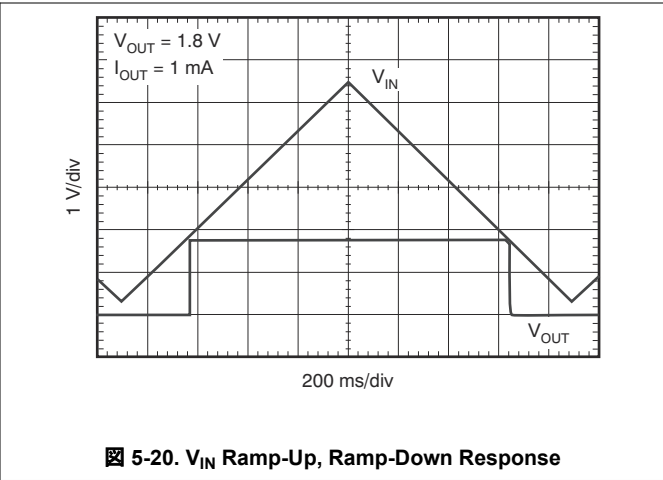
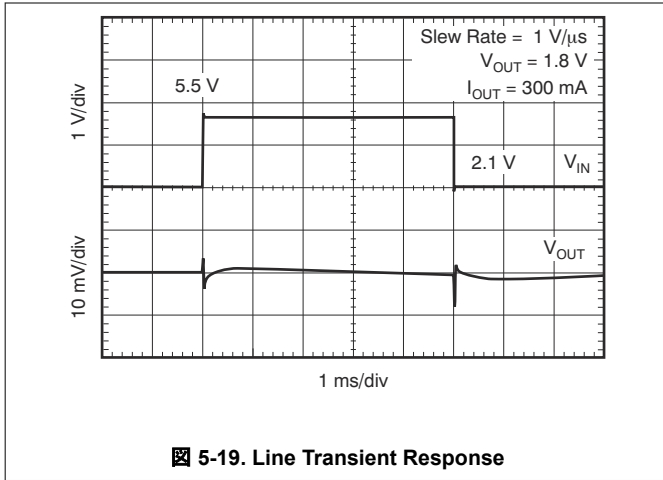



## 6 Detailed Description

### 6.1 Overview

The TLV70018-Q1 and TLV70012-Q1 low-dropout (LDO) linear regulators are low-quiescent-current devices with excellent line and load transient performance. These LDOs are designed for power-sensitive applications. A precision bandgap and error amplifier provides overall 2% accuracy together with low output noise, very high power-supply rejection ratio (PSRR), and low dropout voltage.

### 6.2 Functional Block Diagram

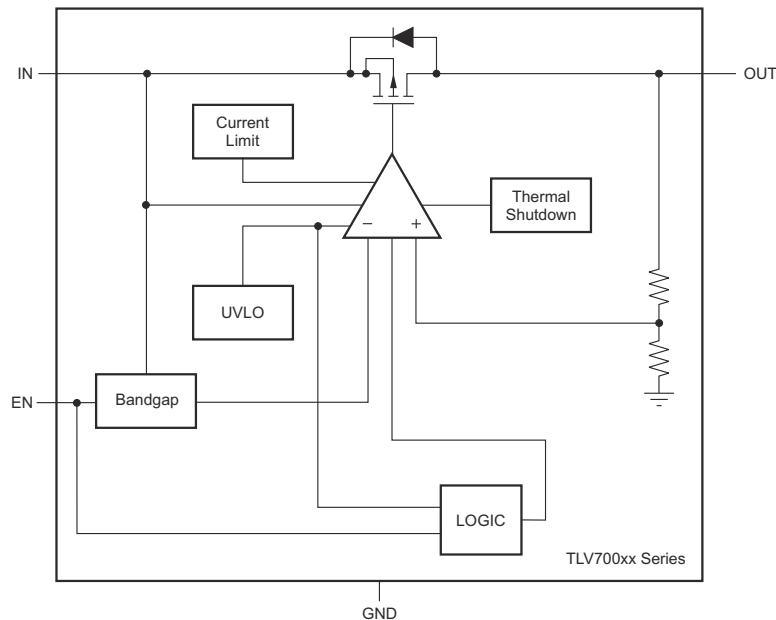

### 6.3 Feature Description

#### 6.3.1 Internal Current Limit

The TLV70018-Q1 and TLV70012-Q1 internal current limit helps to protect the regulator during fault conditions. During current limit, the output sources a fixed amount of current that is largely independent of the output voltage. In such a case, the output voltage is not regulated, and is  $V_{OUT} = I_{LIMIT} \times R_{LOAD}$ . The PMOS pass transistor dissipates  $(V_{IN} - V_{OUT}) \times I_{LIMIT}$  until thermal shutdown is triggered and the device turns off. As the device cools, it is turned on by the internal thermal shutdown circuit. If the fault condition continues, the device cycles between current limit and thermal shutdown. See the [Thermal Considerations](#) section for more details.

The PMOS pass transistor in the TLV70018-Q1 and TLV70012-Q1 has a built-in body diode that conducts current when the voltage at OUT exceeds the voltage at IN. This current is not limited, so if extended reverse voltage operation is anticipated, external limiting to 5% of the rated output current is recommended.

#### 6.3.2 Dropout Voltage

The TLV70018-Q1 and TLV70012-Q1 use a PMOS pass transistor to achieve low dropout. When  $(V_{IN} - V_{OUT})$  is less than the dropout voltage ( $V_{DO}$ ), the PMOS pass transistor is in the linear region of operation and the input-to-output resistance is the  $R_{DS(ON)}$  of the PMOS pass transistor.  $V_{DO}$  scales approximately with output current because the PMOS transistor behaves as a resistor in dropout.

As with any linear regulator, PSRR and transient response are degraded as  $(V_{IN} - V_{OUT})$  approaches dropout. [Figure 5-11](#) illustrates this effect.

#### 6.3.3 Undervoltage Lockout (UVLO)

The TLV70018-Q1 and TLV70012-Q1 use an undervoltage lockout circuit to keep the output shut off until internal circuitry is operating properly.

### 6.3.4 Thermal Shutdown

Thermal protection disables the output when the junction temperature rises to approximately 165°C, allowing the device to cool. When the junction temperature cools to approximately 145°C, the output circuitry is again enabled. Depending on power dissipation, thermal resistance, and ambient temperature, the thermal protection circuit may cycle on and off. This cycling limits the dissipation of the regulator, protecting it from damage as a result of overheating.

Any tendency to activate the thermal protection circuit indicates excessive power dissipation or an inadequate heatsink. For reliable operation, junction temperature should be limited to 125°C maximum. To estimate the margin of safety in a complete design (including heatsink), increase the ambient temperature until the thermal protection is triggered; use worst-case loads and signal conditions. For good reliability, thermal protection should trigger at least 40°C above the maximum expected ambient condition of the particular application. This configuration produces a worst-case junction temperature of 125°C at the highest expected ambient temperature and worst-case load.

The internal protection circuitry of the TLV70018-Q1 and TLV70012-Q1 has been designed to protect against overload conditions. It was not intended to replace proper heatsinking. Continuously running the TLV70018-Q1 or TLV70012-Q1 into thermal shutdown degrades device reliability.

## 6.4 Device Functional Modes

### 6.4.1 Shutdown

The enable pin (EN) is active high. The device is enabled when voltage at EN pin goes above 0.9V. This relatively lower value of voltage required to turn the LDO on can be exploited to power the LDO with a GPIO of recent processors whose GPIO logic 1 voltage level is lower than traditional microcontrollers. The device is turned off when the EN pin is held at less than 0.4V. When shutdown capability is not required, EN can be connected to the IN pin.

### 6.4.2 Operation with $V_{IN}$ Less than 2V

The TLV70018-Q1 and TLV70012-Q1 devices operate with input voltages above 2V. The typical UVLO voltage is 1.9V and the device operates at an input voltage above 2V. When input voltage falls below UVLO voltage, the device will shutdown.

### 6.4.3 Operation with $V_{IN}$ Greater than 2V

When  $V_{IN}$  is greater than 2V, if input voltage is higher than desired output voltage plus dropout voltage, the output voltage is equal to the desired value. Otherwise, output voltage will be  $V_{IN}$  minus dropout voltage.

## 7 Application and Implementation

### 注

以下のアプリケーション情報は、TI の製品仕様に含まれるものではなく、TI ではその正確性または完全性を保証いたしません。個々の目的に対する製品の適合性については、お客様の責任で判断していただくこととなります。お客様は自身の設計実装を検証しテストすることで、システムの機能を確認する必要があります。

### 7.1 Application Information

The TLV70018-Q1 and TLV70012-Q1 consume low quiescent current and deliver excellent line and load transient performance. These characteristics, combined with low noise and very good PSRR with little ( $V_{IN} - V_{OUT}$ ) headroom, make this family of devices ideal for portable RF applications. This family of regulators offers current limit and thermal protection, and is specified from  $-40^{\circ}\text{C}$  to  $125^{\circ}\text{C}$ .

### 7.2 Typical Application



図 7-1. Simplified Schematic

#### 7.2.1 Design Requirements

For this design example use, the parameters listed in 表 7-1 as the input parameters.

表 7-1. Design Parameters

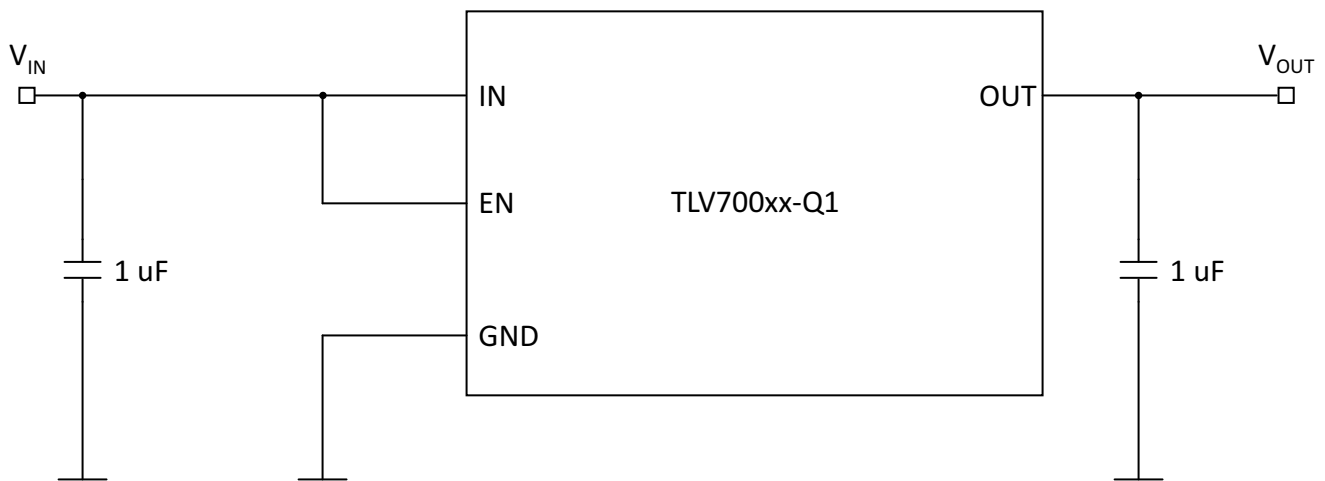
PARAMETER	EXAMPLE VALUE
Input voltage range	2V to 5.5V
Output voltage	1.2V, 1.8V
Output current rating	300mA
Effective output capacitor range	>0.1 $\mu\text{F}$
Maximum output capacitor ESR range	<200m $\Omega$

## 7.2.2 Detailed Design Procedure

### 7.2.2.1 Input and Output Capacitor Requirements

1.0 $\mu$ F X5R- and X7R-type ceramic capacitors are recommended because these capacitors have minimal variation in value and equivalent series resistance (ESR) over temperature.

However, the TLV70018-Q1 and TLV70012-Q1 are designed to be stable with an *effective capacitance* of 0.1 $\mu$ F or larger at the output. Thus, the device is stable with capacitors of other dielectric types as well, as long as the effective capacitance under operating bias voltage and temperature is greater than 0.1 $\mu$ F. This effective capacitance refers to the capacitance that the LDO sees under operating bias voltage and temperature conditions; that is, the capacitance after taking both bias voltage and temperature derating into consideration. In addition to allowing the use of lower-cost dielectrics, this capability of being stable with 0.1 $\mu$ F effective capacitance also enables the use of smaller-footprint capacitors that have higher derating in size- and space-constrained applications.

#### 注

Using a 0.1 $\mu$ F rated capacitor at the output of the LDO does not provide stability because the effective capacitance under the specified operating conditions would be less than 0.1 $\mu$ F. Maximum ESR should be less than 200m $\Omega$ .

Although an input capacitor is not required for stability, good analog design practice is to connect a 0.1 $\mu$ F to 1.0 $\mu$ F, low ESR capacitor across the IN pin and GND pin of the regulator. This capacitor counteracts reactive input sources and improves transient response, noise rejection, and ripple rejection. A higher-value capacitor may be necessary if large, fast rise-time load transients are anticipated, or if the device is not located close to the power source. If source impedance is more than 2 $\Omega$ , a 0.1 $\mu$ F input capacitor may be necessary to ensure stability.

### 7.2.2.2 Transient Response

As with any regulator, increasing the size of the output capacitor reduces overshoot or undershoot magnitude but increases the duration of the transient response.

## 7.2.3 Application Curve

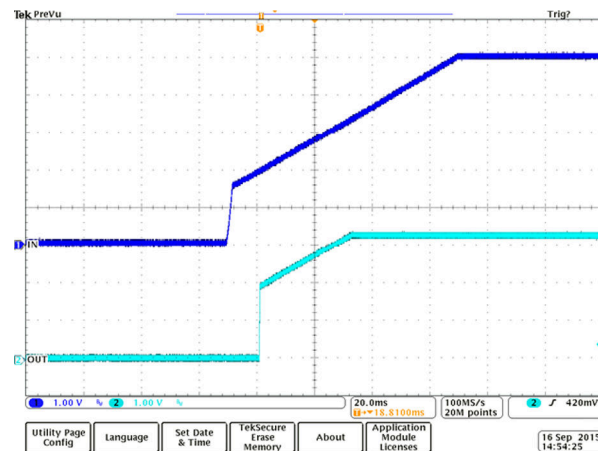

7-2. Power-Up

## 7.3 Power Supply Recommendations

The device is designed to operate from an input-voltage supply range between 2V and 5.5V. This input supply must be well regulated. If the input supply is located more than a few inches from the device, TI recommends adding a capacitor with a value of 0.1 $\mu$ F and a ceramic bypass capacitor at the input.

## 7.4 Layout

### 7.4.1 Layout Guidelines

Input and output capacitors should be placed as close to the device pins as possible. To improve ac performance such as PSRR, output noise, and transient response, the board is recommended to be designed with separate ground planes for  $V_{IN}$  and  $V_{OUT}$ , with the ground plane connected only at the GND pin of the device. In addition, the ground connection for the output capacitor should be connected directly to the GND pin of the device. High ESR capacitors may degrade PSRR performance.

#### 7.4.1.1 Thermal Considerations

Any tendency to activate the thermal protection circuit indicates excessive power dissipation or an inadequate heatsink. For reliable operation, junction temperature should be limited to 125°C maximum.

To estimate the margin of safety in a complete design (including heatsink), increase the ambient temperature until the thermal protection is triggered; use worst-case loads and signal conditions.

#### 7.4.1.2 Power Dissipation

The ability to remove heat from the die is different for each package type, presenting different considerations in the printed circuit board (PCB) layout. The PCB area around the device that is free of other components moves the heat from the device to the ambient air.

Thermal performance data for TLV70018-Q1 and TLV70012-Q1 were gathered using the [TLV700 evaluation module](#) (EVM), a 2-layer board with two ounces of copper per side. Corresponding thermal performance data are given in [Thermal Information](#). Note that this board has provision for soldering not only the SOT23-5 package on the bottom layer, but also the SC-70 package on the top layer. Using heavier copper increases the effectiveness in removing heat from the device. The addition of plated through-holes to heat-dissipating layers also improves heatsink effectiveness.

### 7.4.1.2.1 Thermal Calculations

Power dissipation depends on input voltage and load conditions. Power dissipation ( $P_D$ ) is equal to the product of the output current and the voltage drop across the output pass transistor, as shown in 式 1.

$$P_D = I_{OUT} \times (V_{IN} - V_{OUT}) + I_Q \times V_{IN} \tag{1}$$

where

- $P_D$  is continuous power dissipation
- $I_{OUT}$  is output current
- $V_{IN}$  is input voltage
- $V_{OUT}$  is output voltage

Because  $I_Q \ll I_{OUT}$ , the term  $I_Q \times V_{IN}$  is always ignored.

For a device under operation at a given ambient air temperature ( $T_A$ ), use 式 2 to calculate the junction temperature ( $T_J$ ).

$$T_J = T_A + (R_{\theta JA} \times P_D) \tag{2}$$

where:

- $Z_{\theta JA}$  is the junction-to-ambient air temperature thermal impedance

Use 式 3 to calculate the rise in junction temperature due to power dissipation.

$$\Delta T = T_J - T_A = (R_{\theta JA} \times P_D) \tag{3}$$

For a given maximum junction temperature ( $T_{J(MAX)}$ ), use 式 4 to calculate the maximum ambient air temperature ( $T_{A(MAX)}$ ) at which the device can operate.

$$T_{Amax} = T_{Jmax} - (R_{\theta JA} \times P_D) \tag{4}$$

### 7.4.2 Layout Example



図 7-3. TLV700xx-Q1 Layout Example

## 8 Device and Documentation Support

### 8.1 Device Support

#### 8.1.1 Device Nomenclature

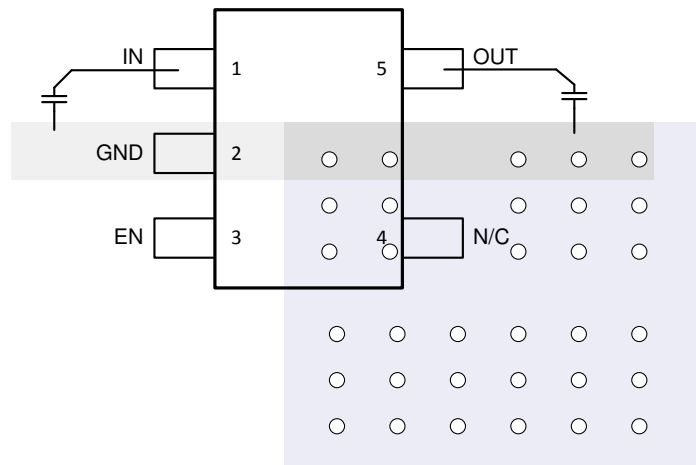
表 8-1. Device Nomenclature

PRODUCT <sup>(1)</sup>	DESCRIPTION
TLV700xxQyyyQ1	<p><b>xx</b> is the nominal output voltage (for example, 28 = 2.8V).</p> <p><b>Q</b> indicates that this device is a grade-1 device in accordance with the AEC-Q100 standard.</p> <p><b>yyy</b> is the package designator.</p> <p><b>z</b> is the tape and reel quantity (R = 3000, T = 250).</p> <p><b>Q1</b> indicates that this device is an automotive grade (AEC-Q100) device.</p>

(1) For the most current package and ordering information see the Package Option Addendum at the end of this document, or see the device product folder at [www.ti.com](http://www.ti.com).

#### 8.1.2 Package Mounting

Solder pad footprint recommendations for the TLV70018-Q1 are available from the Texas Instruments web site at [www.ti.com](http://www.ti.com).

### 8.2 Documentation Support

#### 8.2.1 Related Documentation

For related documentation, see the following:

- Texas Instruments, [TLV700 evaluation module](#)

### 8.3 ドキュメントの更新通知を受け取る方法

ドキュメントの更新についての通知を受け取るには、[www.tij.co.jp](http://www.tij.co.jp) のデバイス製品フォルダを開いてください。[通知] をクリックして登録すると、変更されたすべての製品情報に関するダイジェストを毎週受け取ることができます。変更の詳細については、改訂されたドキュメントに含まれている改訂履歴をご覧ください。

### 8.4 サポート・リソース

テキサス・インスツルメンツ E2E™ サポート・フォーラムは、エンジニアが検証済みの回答と設計に関するヒントをエキスパートから迅速かつ直接得ることができる場所です。既存の回答を検索したり、独自の質問をしたりすることで、設計に必要な支援を迅速に得ることができます。

リンクされているコンテンツは、各寄稿者により「現状のまま」提供されるものです。これらはテキサス・インスツルメンツの仕様を構成するものではなく、必ずしもテキサス・インスツルメンツの見解を反映したものではありません。テキサス・インスツルメンツの[使用条件](#)を参照してください。

### 8.5 Trademarks

テキサス・インスツルメンツ E2E™ is a trademark of Texas Instruments.

すべての商標は、それぞれの所有者に帰属します。

### 8.6 静電気放電に関する注意事項



この IC は、ESD によって破損する可能性があります。テキサス・インスツルメンツは、IC を取り扱う際には常に適切な注意を払うことを推奨します。正しい取り扱いおよび設置手順に従わない場合、デバイスを破損するおそれがあります。

ESD による破損は、わずかな性能低下からデバイスの完全な故障まで多岐にわたります。精密な IC の場合、パラメータがわずかに変化するだけで公表されている仕様から外れる可能性があるため、破損が発生しやすくなっています。

### 8.7 用語集

[テキサス・インスツルメンツ用語集](#)

この用語集には、用語や略語の一覧および定義が記載されています。

## 9 Revision History

資料番号末尾の英字は改訂を表しています。その改訂履歴は英語版に準じています。

### Changes from Revision C (June 2017) to Revision D (January 2025) Page

- ドキュメント全体にわたって表、図、相互参照の採番方法を更新..... 1
- Added *Device Nomenclature* table..... 15

### Changes from Revision B (January 2016) to Revision C (June 2017) Page

- 「特長」の「固定出力電圧」の箇条書き項目を、1.2V から 4.8V に可能な「固定出力電圧」から「固定出力電圧:に変更 1.2V および 1.8V ..... 1
- 「アプリケーション」セクションを変更 ..... 1
- 「概要」セクションの最初の段落を変更: TLV700xx-Q1 シリーズを TLV70018-Q1 および TLV70012-Q1 に変更、2 番目の文を削除、バッテリー駆動式の携帯機器を電力に敏感な負荷を供給するに変更して、安全性をフォルト条件検出に変更..... 1
- 「代表的なアプリケーション」のタイトルから固定電圧バージョンを削除..... 1
- Changed *Input voltage* parameter: changed symbol from  $V_I$  to  $V_{IN}$ , moved EN and OUT rows to standalone parameters ..... 3
- Changed maximum specification of *Output voltage* parameter from 5.5V to 1.8V ..... 3
- Added  $I_{OUT}$  symbol to *Current output* parameter ..... 3
- Deleted TLV70018-Q1 column from *Thermal Information* table ..... 3
- Added TLV70018-Q1 to TLV70012-Q1 column in *Thermal Information* table; all thermal values for TLV70018-Q1 changed to the TLV70012-Q1 thermal values..... 3
- Changed  $V_{OUT(TYP)}$  to  $V_{OUT(NOM)}$  in conditions statement of *Electrical Characteristics* table ..... 4
- Changed symbols for *Line regulation*, *Load regulation*, and *Output noise voltage* parameters from  $\Delta V_O/\Delta V_{IN}$  to  $\Delta V_{OUT}/\Delta V_{IN}$ ,  $\Delta V_O/\Delta I_{OUT}$  to  $\Delta V_{OUT}/\Delta I_{OUT}$ , and  $V_N$  to  $V_n$  (respectively) in *Electrical Characteristics* table ..... 4
- Changed  $V_{OUT(TYP)}$  to  $V_{OUT(NOM)}$  in *Typical Characteristics* conditions statement ..... 5
- Deleted *Dropout Voltage vs Input Voltage* and *Dropout Voltage vs Output Current* curves ..... 5
- Changed TLV700xx-Q1 to TLV70018-Q1 and TLV70012-Q1 in *Overview* section..... 9
- Added TLV70012-Q1 to sub-sections of *Feature Description* and *Device Functional Modes* sections ..... 9
- Changed 160°C to 165°C, 140°C to 145°C, and 35°C to 40°C in *Thermal Shutdown* section ..... 10
- Changed *Application Information* section: changed first two sentences, deleted second paragraph ..... 11
- Changed *Example Value* column values for 2nd and 3rd rows in *Design Parameters* table..... 11
- Added TLV70012-Q1 to *Input and Output Capacitor Requirements* section..... 12
- Deleted first and last paragraphs from *Thermal Considerations* section ..... 13
- Deleted second sentence from second paragraph of *Power Dissipation* section ..... 13
- Added TLV70012-Q1 to *Power Dissipation* section ..... 13

## 10 Mechanical, Packaging, and Orderable Information

The following pages include mechanical, packaging, and orderable information. This information is the most current data available for the designated devices. This data is subject to change without notice and revision of this document. For browser-based versions of this data sheet, refer to the left-hand navigation.



## 重要なお知らせと免責事項

テキサス・インスツルメンツは、技術データと信頼性データ (データシートを含みます)、設計リソース (リファレンス デザインを含みます)、アプリケーションや設計に関する各種アドバイス、Web ツール、安全性情報、その他のリソースを、欠陥が存在する可能性のある「現状のまま」提供しており、商品性および特定目的に対する適合性の黙示保証、第三者の知的財産権の非侵害保証を含むいかなる保証も、明示的または黙示的にかかわらず拒否します。

これらのリソースは、テキサス・インスツルメンツ製品を使用する設計の経験を積んだ開発者への提供を意図したものです。(1) お客様のアプリケーションに適した テキサス・インスツルメンツ製品の選定、(2) お客様のアプリケーションの設計、検証、試験、(3) お客様のアプリケーションに該当する各種規格や、その他のあらゆる安全性、セキュリティ、規制、または他の要件への確実な適合に関する責任を、お客様のみが単独で負うものとします。

上記の各種リソースは、予告なく変更される可能性があります。これらのリソースは、リソースで説明されている テキサス・インスツルメンツ製品を使用するアプリケーションの開発の目的のみ、テキサス・インスツルメンツはその使用をお客様に許諾します。これらのリソースに関して、他の目的で複製することや掲載することは禁止されています。テキサス・インスツルメンツや第三者の知的財産権のライセンスが付与されている訳ではありません。お客様は、これらのリソースを自身で使用した結果発生するあらゆる申し立て、損害、費用、損失、責任について、テキサス・インスツルメンツおよびその代理人を完全に補償するものとし、テキサス・インスツルメンツは一切の責任を拒否します。

テキサス・インスツルメンツの製品は、[テキサス・インスツルメンツの販売条件](#)、または [ti.com](https://www.ti.com) やかかる テキサス・インスツルメンツ製品の関連資料などのいずれかを通じて提供する適用可能な条項の下で提供されています。テキサス・インスツルメンツがこれらのリソースを提供することは、適用されるテキサス・インスツルメンツの保証または他の保証の放棄の拡大や変更を意味するものではありません。

お客様がいかなる追加条項または代替条項を提案した場合でも、テキサス・インスツルメンツはそれらに異議を唱え、拒否します。

郵送先住所: Texas Instruments, Post Office Box 655303, Dallas, Texas 75265

Copyright © 2025, Texas Instruments Incorporated

**PACKAGING INFORMATION**

Orderable Device	Status (1)	Package Type	Package Drawing	Pins	Package Qty	Eco Plan (2)	Lead finish/ Ball material (6)	MSL Peak Temp (3)	Op Temp (°C)	Device Marking (4/5)	Samples
TLV70012QDDCRQ1	ACTIVE	SOT-23-THIN	DDC	5	3000	RoHS & Green	NIPDAU	Level-2-260C-1 YEAR	-40 to 125	SDO	<a href="#">Samples</a>
TLV70018QDDCRQ1	ACTIVE	SOT-23-THIN	DDC	5	3000	RoHS & Green	NIPDAU	Level-2-260C-1 YEAR	-40 to 125	DAL	<a href="#">Samples</a>

(1) The marketing status values are defined as follows:

**ACTIVE:** Product device recommended for new designs.

**LIFEBUY:** TI has announced that the device will be discontinued, and a lifetime-buy period is in effect.

**NRND:** Not recommended for new designs. Device is in production to support existing customers, but TI does not recommend using this part in a new design.

**PREVIEW:** Device has been announced but is not in production. Samples may or may not be available.

**OBSOLETE:** TI has discontinued the production of the device.

(2) **RoHS:** TI defines "RoHS" to mean semiconductor products that are compliant with the current EU RoHS requirements for all 10 RoHS substances, including the requirement that RoHS substance do not exceed 0.1% by weight in homogeneous materials. Where designed to be soldered at high temperatures, "RoHS" products are suitable for use in specified lead-free processes. TI may reference these types of products as "Pb-Free".

**RoHS Exempt:** TI defines "RoHS Exempt" to mean products that contain lead but are compliant with EU RoHS pursuant to a specific EU RoHS exemption.

**Green:** TI defines "Green" to mean the content of Chlorine (Cl) and Bromine (Br) based flame retardants meet JS709B low halogen requirements of <=1000ppm threshold. Antimony trioxide based flame retardants must also meet the <=1000ppm threshold requirement.

(3) MSL, Peak Temp. - The Moisture Sensitivity Level rating according to the JEDEC industry standard classifications, and peak solder temperature.

(4) There may be additional marking, which relates to the logo, the lot trace code information, or the environmental category on the device.

(5) Multiple Device Markings will be inside parentheses. Only one Device Marking contained in parentheses and separated by a "~" will appear on a device. If a line is indented then it is a continuation of the previous line and the two combined represent the entire Device Marking for that device.

(6) Lead finish/Ball material - Orderable Devices may have multiple material finish options. Finish options are separated by a vertical ruled line. Lead finish/Ball material values may wrap to two lines if the finish value exceeds the maximum column width.

**Important Information and Disclaimer:**The information provided on this page represents TI's knowledge and belief as of the date that it is provided. TI bases its knowledge and belief on information provided by third parties, and makes no representation or warranty as to the accuracy of such information. Efforts are underway to better integrate information from third parties. TI has taken and continues to take reasonable steps to provide representative and accurate information but may not have conducted destructive testing or chemical analysis on incoming materials and chemicals. TI and TI suppliers consider certain information to be proprietary, and thus CAS numbers and other limited information may not be available for release.

In no event shall TI's liability arising out of such information exceed the total purchase price of the TI part(s) at issue in this document sold by TI to Customer on an annual basis.



**TAPE AND REEL INFORMATION**

**QUADRANT ASSIGNMENTS FOR PIN 1 ORIENTATION IN TAPE**



\*All dimensions are nominal

Device	Package Type	Package Drawing	Pins	SPQ	Reel Diameter (mm)	Reel Width W1 (mm)	A0 (mm)	B0 (mm)	K0 (mm)	P1 (mm)	W (mm)	Pin1 Quadrant
TLV70012QDDCRQ1	SOT-23-THIN	DDC	5	3000	179.0	8.4	3.2	3.2	1.4	4.0	8.0	Q3
TLV70018QDDCRQ1	SOT-23-THIN	DDC	5	3000	180.0	8.4	3.2	3.2	1.4	4.0	8.0	Q3

**TAPE AND REEL BOX DIMENSIONS**

\*All dimensions are nominal

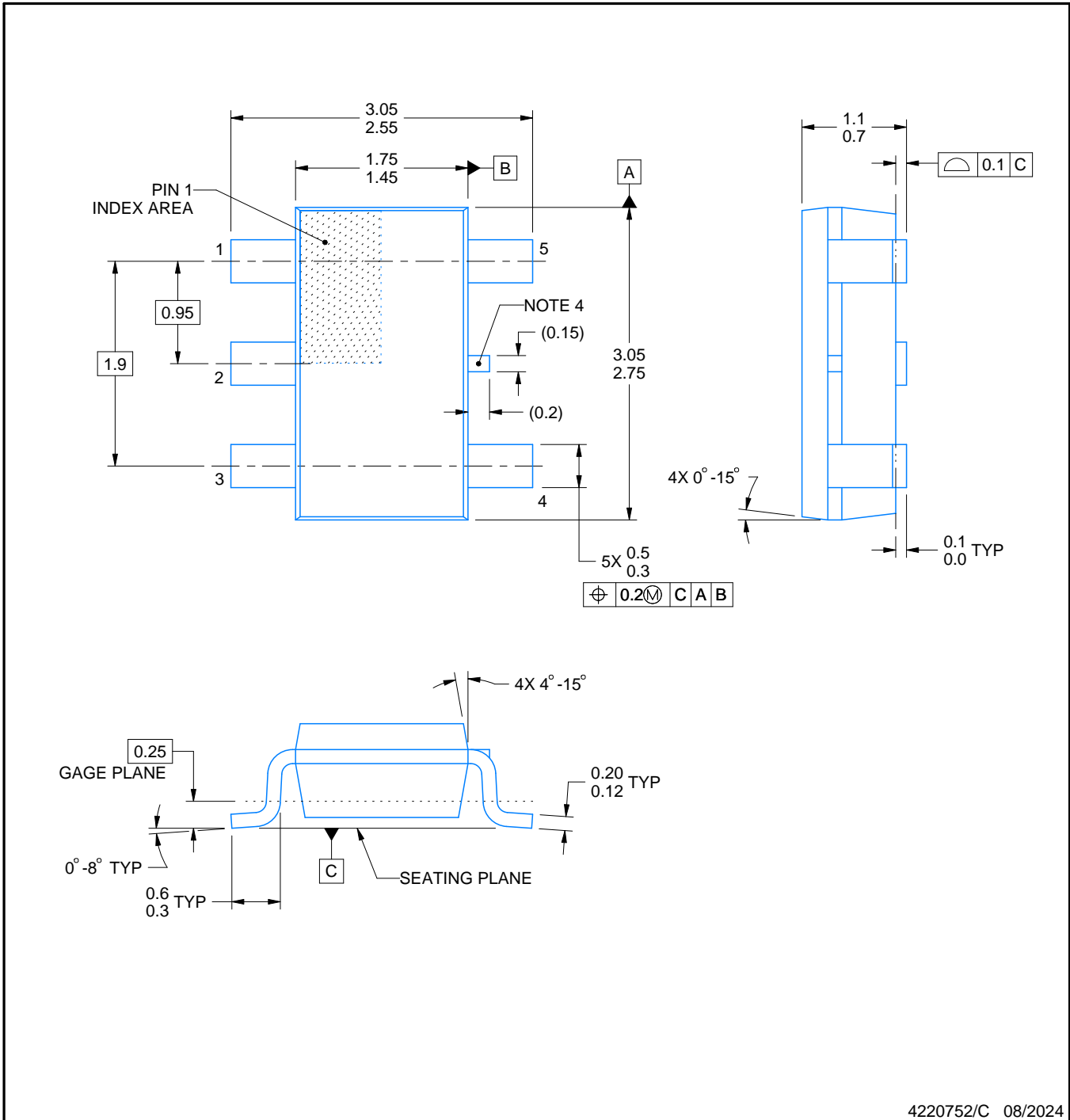
Device	Package Type	Package Drawing	Pins	SPQ	Length (mm)	Width (mm)	Height (mm)
TLV70012QDDCRQ1	SOT-23-THIN	DDC	5	3000	213.0	191.0	35.0
TLV70018QDDCRQ1	SOT-23-THIN	DDC	5	3000	213.0	191.0	35.0



NOTES:

- 1. All linear dimensions are in millimeters. Any dimensions in parenthesis are for reference only. Dimensioning and tolerancing per ASME Y14.5M.
- 2. This drawing is subject to change without notice.
- 3. Reference JEDEC MO-193.
- 4. Support pin may differ or may not be present.

# EXAMPLE BOARD LAYOUT

DDC0005A

SOT-23 - 1.1 max height

SMALL OUTLINE TRANSISTOR

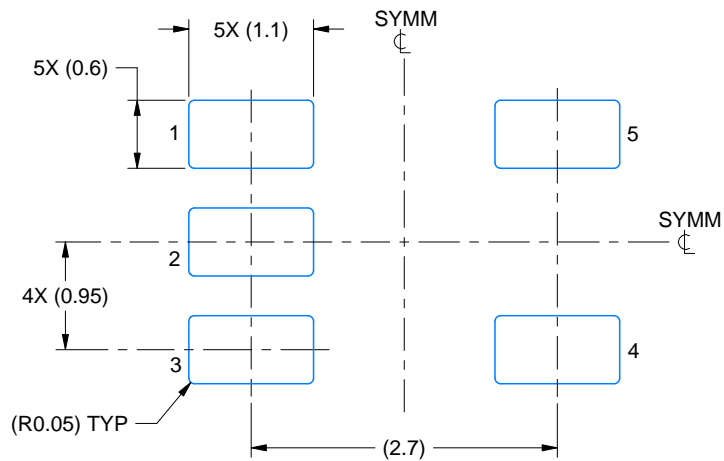

LAND PATTERN EXAMPLE  
EXPLODED METAL SHOWN  
SCALE:15X

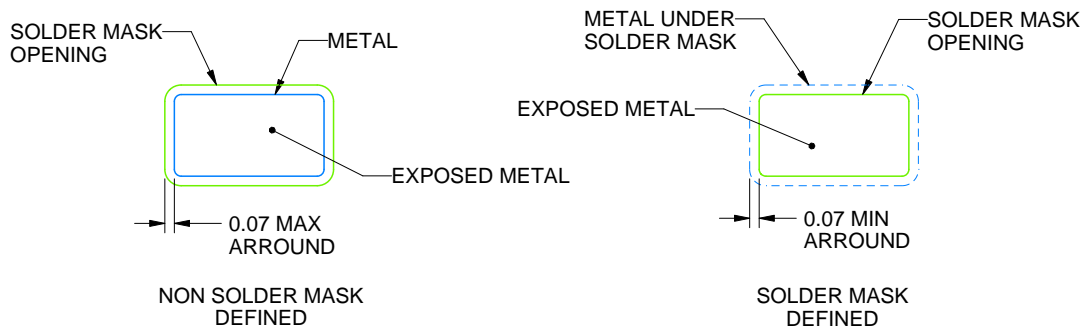

SOLDERMASK DETAILS

4220752/C 08/2024

NOTES: (continued)

- 4. Publication IPC-7351 may have alternate designs.
- 5. Solder mask tolerances between and around signal pads can vary based on board fabrication site.

# EXAMPLE STENCIL DESIGN

DDC0005A

SOT-23 - 1.1 max height

SMALL OUTLINE TRANSISTOR

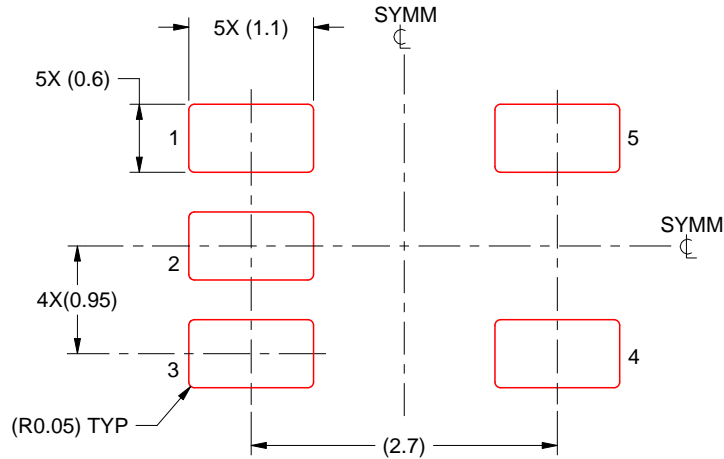

SOLDER PASTE EXAMPLE  
BASED ON 0.125 THICK STENCIL  
SCALE:15X

4220752/C 08/2024

NOTES: (continued)

6. Laser cutting apertures with trapezoidal walls and rounded corners may offer better paste release. IPC-7525 may have alternate design recommendations.
7. Board assembly site may have different recommendations for stencil design.



## 重要なお知らせと免責事項

テキサス・インスツルメンツは、技術データと信頼性データ(データシートを含みます)、設計リソース(リファレンス デザインを含みます)、アプリケーションや設計に関する各種アドバイス、Web ツール、安全性情報、その他のリソースを、欠陥が存在する可能性のある「現状のまま」提供しており、商品性および特定目的に対する適合性の黙示保証、第三者の知的財産権の非侵害保証を含むいかなる保証も、明示的または黙示的にかかわらず拒否します。

これらのリソースは、テキサス・インスツルメンツ製品を使用する設計の経験を積んだ開発者への提供を意図したものです。(1) お客様のアプリケーションに適したテキサス・インスツルメンツ製品の選定、(2) お客様のアプリケーションの設計、検証、試験、(3) お客様のアプリケーションに該当する各種規格や、その他のあらゆる安全性、セキュリティ、規制、または他の要件への確実な適合に関する責任を、お客様のみが単独で負うものとし、ます。

上記の各種リソースは、予告なく変更される可能性があります。これらのリソースは、リソースで説明されているテキサス・インスツルメンツ製品を使用するアプリケーションの開発の目的でのみ、テキサス・インスツルメンツはその使用をお客様に許諾します。これらのリソースに関して、他の目的で複製することや掲載することは禁止されています。テキサス・インスツルメンツや第三者の知的財産権のライセンスが付与されている訳ではありません。お客様は、これらのリソースを自身で使用した結果発生するあらゆる申し立て、損害、費用、損失、責任について、テキサス・インスツルメンツおよびその代理人を完全に補償するものとし、テキサス・インスツルメンツは一切の責任を拒否します。

テキサス・インスツルメンツの製品は、[テキサス・インスツルメンツの販売条件](#)、または [ti.com](https://www.ti.com) やかかるテキサス・インスツルメンツ製品の関連資料などのいずれかを通じて提供する適用可能な条項の下で提供されています。テキサス・インスツルメンツがこれらのリソースを提供することは、適用されるテキサス・インスツルメンツの保証または他の保証の放棄の拡大や変更を意味するものではありません。

お客様がいかなる追加条項または代替条項を提案した場合でも、テキサス・インスツルメンツはそれらに異議を唱え、拒否します。

郵送先住所：Texas Instruments, Post Office Box 655303, Dallas, Texas 75265  
Copyright © 2025, Texas Instruments Incorporated