

TLE206x, TLE206xA, TLE206xB
EXCALIBUR JFET-INPUT HIGH-OUTPUT-DRIVE
μPOWER OPERATIONAL AMPLIFIERS
SLOS193B – FEBRUARY 1997 – REVISED MAY 2004

- **2× Bandwidth (2 MHz) of the TL06x and TL03x Operational Amplifiers**
- **Low Supply Current . . . 290 μA/Ch Typ**
- **On-chip Offset Voltage Trimming for Improved DC Performance**
- **High Output Drive, Specified into 100-Ω Loads**
- **Lower Noise Floor Than Earlier Generations of Low-Power BiFETs**

description

The TLE206x series of low-power JFET-input operational amplifiers doubles the bandwidth of the earlier generation TL06x and TL03x BiFET families without significantly increasing power consumption. Texas Instruments Excalibur process also delivers a lower noise floor than the TL06x and TL03x. On-chip zener trimming of offset voltage yields precision grades for dc-coupled applications. The TL206x devices are pin-compatible with other Texas Instruments BiFETs; they can be used to double the bandwidth of TL06x and TL03x circuits or to reduce power consumption of TL05x, TL07x, and TL08x circuits by nearly 90%.

BiFET operational amplifiers offer the inherently-higher input impedance of the JFET-input transistors, without sacrificing the output drive associated with bipolar amplifiers. This makes them better suited for interfacing with high-impedance sensors or low-level ac signals. They also feature inherently better ac response than bipolar or CMOS devices having comparable power consumption. The TLE206x family features a high-output-drive circuit capable of driving 100-Ω loads at supplies as low as ± 5 V. This makes them uniquely suited for driving transformer loads in modems and other applications requiring good ac characteristics, low power, and high output drive.

Because BiFET operational amplifiers are designed for use with dual power supplies, care must be taken to observe common-mode input voltage limits and output swing when operating from a single supply. DC biasing of the input signal is required and loads should be terminated to a virtual ground node at mid-supply. Texas Instruments TLE2426 integrated virtual ground generator is useful when operating BiFET amplifiers from single supplies.

The TLE206x are fully specified at ± 15 V and ± 5 V. For operation in low-voltage and/or single-supply systems, Texas Instruments LinCMOS families of operational amplifiers (TLC- and TLV-prefixes) are recommended. When moving from BiFET to CMOS amplifiers, particular attention should be paid to slew rate and bandwidth requirements and output loading. The Texas Instruments TLV2432 and TLV2442 CMOS operational amplifiers are excellent choices to consider.



Please be aware that an important notice concerning availability, standard warranty, and use in critical applications of Texas Instruments semiconductor products and disclaimers thereto appears at the end of this data sheet.

PRODUCTION DATA information is current as of publication date. Products conform to specifications per the terms of Texas Instruments standard warranty. Production processing does not necessarily include testing of all parameters.



POST OFFICE BOX 655303 • DALLAS, TEXAS 75265

Copyright © 2004, Texas Instruments Incorporated

TLE206x, TLE206xA, TLE206xB EXCALIBUR JFET-INPUT HIGH-OUTPUT-DRIVE μ POWER OPERATIONAL AMPLIFIERS

SLOS193B – FEBRUARY 1997 – REVISED MAY 2004

TLE2061 AVAILABLE OPTIONS

| PACKAGED DEVICES | | | | | | | |
|------------------|--------------------------------|--------------------------|-------------------------|------------------------|-----------------------|----------------|-----------------------------|
| T _A | V _{IO} max AT 25°C | SMALL OUTLINE† (D) | CHIP CARRIER (FK) | CERAMIC DIP (JG) | PLASTIC DIP (P) | TSSOP‡ (PW) | CERAMIC FLAT PACK (U) |
| 0°C to 70°C | 500 μ V | — | — | — | — | — | — |
| | 1.5 mV | TLE2061ACD | — | — | TLE2061ACP | — | — |
| | 3 mV | TLE2061CD | — | — | TLE2061CP | TLE2061CPWLE | — |
| –40°C to 85°C | 500 μ V | — | — | — | — | — | — |
| | 1.5 mV | TLE2061AID | — | — | TLE2061AIP | — | — |
| | 3 mV | TLE2061ID | — | — | TLE2061IP | — | — |
| –55°C to 125°C | 500 μ V | — | — | TLE2061BMJG | — | — | — |
| | 1.5 mV | TLE2061AMD | TLE2061AMFK | TLE2061AMJG | — | — | TLE2061AMU |
| | 3 mV | TLE2061MD | TLE2061MFK | TLE2061MJG | — | — | TLE2061MU |

† The D packages are available taped and reeled. Add R suffix to device type (e.g., TLE2061ACDR). Chips are tested at 25°C.

‡ The PW package is available left-end taped and reeled (indicated by the LE suffix on the device type (e.g., TLE2061CPWLE)).

TLE2062 AVAILABLE OPTIONS

| PACKAGED DEVICES | | | | | | |
|----------------------|--------------------------------|-----------------------|----------------------|---------------------|--------------------|-----------------------------|
| T _A | V _{IO} max AT 25°C | SMALL OUTLINE† (D) | CHIP CARRIER (FK) | CERAMIC DIP (JG) | PLASTIC DIP (P) | CERAMIC FLAT PACK (U) |
| 0°C to 70°C | 1 mV | TLE2062BCD | — | — | TLE2062BCP | — |
| | 2 mV | TLE2062ACD | — | — | TLE2062ACP | — |
| | 4 mV | TLE2062CD | — | — | TLE2062CP | — |
| –40°C to 85°C | 1 mV | TLE2062BID | — | — | TLE2062BIP | — |
| | 2 mV | TLE2062AID | — | — | TLE2062AIP | — |
| | 4 mV | TLE2062ID | — | — | TLE2062IP | — |
| –55°C to 125°C | 1 mV | TLE2062BMD | — | TLE2062BMJG | — | — |
| | 2 mV | TLE2062AMD | TLE2062AMFK | TLE2062AMJG | — | TLE2062AMU |
| | 4 mV | TLE2062MD | TLE2062MFK | TLE2062MJG | — | TLE2062MU |

† The D packages are available taped and reeled. Add R suffix to device type (e.g., TLE2062ACDR).

TLE2064 AVAILABLE OPTIONS

| PACKAGED DEVICES | | | | | | |
|----------------------|--------------------------------|-----------------------|----------------------|--------------------|--------------------|-----------------------------|
| T _A | V _{IO} max AT 25°C | SMALL OUTLINE† (D) | CHIP CARRIER (FK) | CERAMIC DIP (J) | PLASTIC DIP (N) | CERAMIC FLAT PACK (W) |
| 0°C to 70°C | 2 mV | — | — | — | TLE2064BCN | — |
| | 4 mV | TLE2064ACD | — | — | TLE2064ACN | — |
| | 6 mV | TLE2064CD | — | — | TLE2064CN | — |
| –40°C to 85°C | 2 mV | — | — | — | TLE2064BIN | — |
| | 4 mV | TLE2064AID | — | — | TLE2064AIN | — |
| | 6 mV | TLE2064ID | — | — | TLE2064IN | — |
| –55°C to 125°C | 2 mV | — | TLE2064BMFK | TLE2064BMJ | — | — |
| | 4 mV | TLE2064AMD | TLE2064AMFK | TLE2064AMJ | — | TLE2064AMW |
| | 6 mV | TLE2064MD | TLE2064MFK | TLE2064MJ | — | TLE2064MW |

† The D packages are available taped and reeled. Add R suffix to device type, (e.g., TLE2064ACDR).



TLE206x, TLE206xA, TLE206xB EXCALIBUR JFET-INPUT HIGH-OUTPUT-DRIVE μPOWER OPERATIONAL AMPLIFIERS

SLOS193B – FEBRUARY 1997 – REVISED MAY 2004

**TLE2061, TLE2061A, AND TLE2061B
D, DB, JG, P, OR PW PACKAGE
(TOP VIEW)**



**TLE2062, TLE2062A, TLE2062B
D, JG, OR P PACKAGE
(TOP VIEW)**



**TLE2064, TLE2064A, TLE2064B
D, J, N, OR W PACKAGE
(TOP VIEW)**

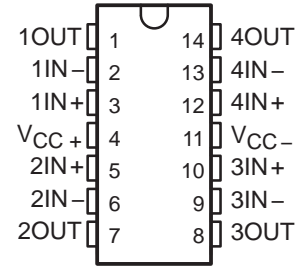

**TLE2061M, TLE2061AM, TLE2061BM
FK PACKAGE
(TOP VIEW)**

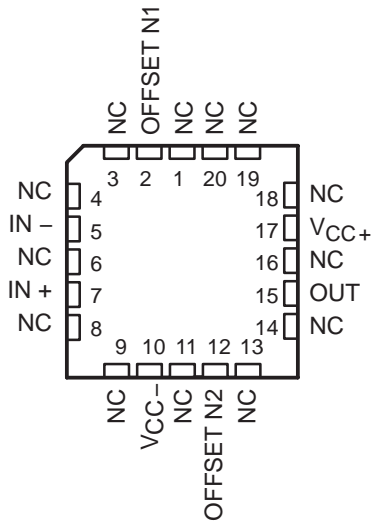

**TLE2062M, TLE2062AM, TLE2062BM
FK PACKAGE
(TOP VIEW)**



**TLE2064M, TLE2064AM, TLE2064BM
FK PACKAGE
(TOP VIEW)**

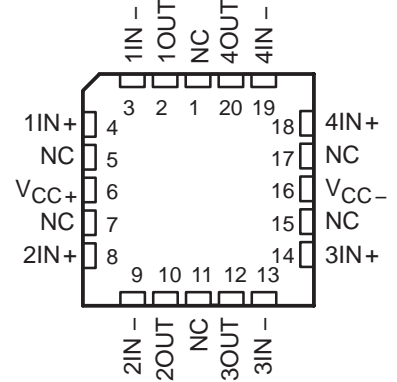

**TLE2061 AND TLE2061A
U PACKAGE
(TOP VIEW)**

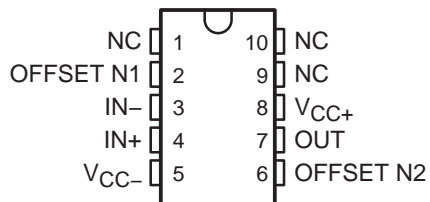

**TLE2062 AND TLE2062A
U PACKAGE
(TOP VIEW)**

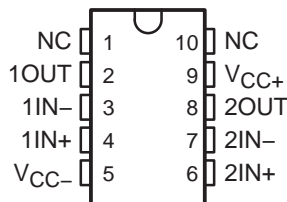

NC – No internal connection

TLE206x, TLE206xA, TLE206xB
EXCALIBUR JFET-INPUT HIGH-OUTPUT-DRIVE
μPOWER OPERATIONAL AMPLIFIERS

SLOS193B – FEBRUARY 1997 – REVISED MAY 2004

absolute maximum ratings over operating free-air temperature range (unless otherwise noted)†

| | | |
|-----------------------------------------------------------------------------------|--------------------|----------------|
| Supply voltage, V_{CC+} (see Note 1) | 19 V | |
| Supply voltage, V_{CC-} | –19 V | |
| Differential input voltage, V_{ID} (see Note 2) | ±38 V | |
| Input voltage range, V_I (any input) | ± V_{CC} | |
| Input current, I_I (each input) | ±1 mA | |
| Output current, I_O | ±80 mA | |
| Total current into V_{CC+} | 80 mA | |
| Total current out of V_{CC-} | –80 mA | |
| Duration of short-circuit current at (or below) 25°C (see Note 3) | unlimited | |
| Package thermal impedance, θ_{JA} (see Notes 4 and 5): | D package (8-pin) | 97.1°C/W |
| | D package (14-pin) | 86.2°C/W |
| | N package | 79.7°C/W |
| | P package | 84.6°C/W |
| | PW package | 113°C/W |
| Package thermal impedance, θ_{JC} (see Notes 4 and 5): | FK package | 5.6°C/W |
| | J package | 15.1°C/W |
| | JG package | 14.5°C/W |
| | U package | 14.7°C/W |
| | W package | 10°C/W |
| Operating free-air temperature range, T_A : | C suffix | 0°C to 70°C |
| | I suffix | –40°C to 85°C |
| | M suffix | –55°C to 125°C |
| Storage temperature range | –65°C to 150°C | |
| Case temperature for 60 seconds: FK package | 260°C | |
| Lead temperature 1,6 mm (1/16 inch) from case for 10 seconds: D, P, or PW package | 260°C | |
| Lead temperature 1,6 mm (1/16 inch) from case for 60 seconds: JG, U, or W package | 300°C | |

† Stresses beyond those listed under “absolute maximum ratings” may cause permanent damage to the device. These are stress ratings only, and functional operation of the device at these or any other conditions beyond those indicated under “recommended operating conditions” is not implied. Exposure to absolute-maximum-rated conditions for extended periods may affect device reliability.

- NOTES:
1. All voltage values, except differential voltages, are with respect to the midpoint between V_{CC+} and V_{CC-} .
 2. Differential voltages are at $IN+$ with respect to $IN-$.
 3. The output may be shorted to either supply. Temperature and/or supply voltages must be limited to ensure that the maximum dissipation rating is not exceeded.
 4. Maximum power dissipation is a function of $T_J(max)$, θ_{JA} , and T_A . The maximum allowable power dissipation at any allowable ambient temperature is $P_D = (T_J(max) - T_A)/\theta_{JA}$. Operating at the absolute maximum T_J of 150°C can affect reliability.
 5. The package thermal impedance is calculated in accordance with JESD 51-7 (plastic) or MIL-STD-883 Method 1012 (ceramic).

recommended operating conditions

| | C SUFFIX | | I SUFFIX | | M SUFFIX | | UNIT |
|---------------------------------------|------------------------|-----|----------|-----|----------|-----|------|
| | MIN | MAX | MIN | MAX | MIN | MAX | |
| Supply voltage, $V_{CC\pm}$ | ±3.5 | ±18 | ±3.5 | ±18 | ±3.5 | ±18 | V |
| Common-mode input voltage, V_{IC} | $V_{CC\pm} = \pm 5$ V | | –1.6 | 4 | –1.6 | 4 | V |
| | $V_{CC\pm} = \pm 15$ V | | –11 | 13 | –11 | 13 | |
| Operating free-air temperature, T_A | 0 | 70 | –40 | 85 | –55 | 125 | °C |



TLE206x, TLE206xA, TLE206xB
EXCALIBUR JFET-INPUT HIGH-OUTPUT-DRIVE
μPOWER OPERATIONAL AMPLIFIERS

SLOS193B – FEBRUARY 1997 – REVISED MAY 2004

TLE2061C electrical characteristics at specified free-air temperature, $V_{CC\pm} = \pm 5\text{ V}$ (unless otherwise noted)

| PARAMETER | | TEST CONDITIONS | T_A † | TLE2061C TLE2061AC TLE2061BC | | | UNIT |
|-------------------------------------------------------------------------------|------------------------------------------------------------------------------|--------------------------------|------------|------------------------------------|------------------------------|-------------------------|------|
| | | | | MIN | TYP | MAX | |
| V_{IO} Input offset voltage | TLE2061C | $V_{IC} = 0, R_S = 50\ \Omega$ | 25°C | 0.8 | 3.1 | mV | |
| | | | Full range | 4 | | | |
| | TLE2061AC | | 25°C | 0.6 | 2.6 | | |
| | | | Full range | 3.5 | | | |
| | TLE2061BC | | 25°C | 0.5 | 1.9 | | |
| | | | Full range | 2.4 | | | |
| α_{VIO} Temperature coefficient of input offset voltage | | Full range | 6 | | $\mu\text{V}/^\circ\text{C}$ | | |
| Input offset voltage long-term drift (see Note 4) | | | 25°C | 0.04 | | $\mu\text{V}/\text{mo}$ | |
| I_{IO} Input offset current | | | 25°C | 1 | | pA | |
| | | | Full range | 0.8 | | nA | |
| I_{IB} Input bias current | | | 25°C | 3 | | pA | |
| | | | Full range | 2 | | nA | |
| V_{ICR} Common-mode input voltage range | | | 25°C | -1.6 to 4 | -2 to 6 | V | |
| | | | Full range | -1.6 to 4 | | V | |
| V_{OM+} Maximum positive peak output voltage swing | $R_L = 10\ \text{k}\Omega$ | | 25°C | 3.5 | 3.7 | V | |
| | | | Full range | 3.3 | | | |
| | $R_L = 100\ \Omega$ | | 25°C | 2.5 | 3.1 | | |
| | | | Full range | 2 | | | |
| V_{OM-} Maximum negative peak output voltage swing | $R_L = 10\ \text{k}\Omega$ | | 25°C | -3.7 | -3.9 | V | |
| | | | Full range | -3.3 | | | |
| | $R_L = 100\ \Omega$ | | 25°C | -2.5 | -2.7 | | |
| | | | Full range | -2 | | | |
| A_{VD} Large-signal differential voltage amplification | $V_O = \pm 2.8\ \text{V}, R_L = 10\ \text{k}\Omega$ | | 25°C | 15 | 80 | V/mV | |
| | | | Full range | 2 | | | |
| | $V_O = 0\ \text{to}\ 2\ \text{V}, R_L = 100\ \Omega$ | | 25°C | 0.75 | 45 | | |
| | | | Full range | 0.5 | | | |
| | $V_O = 0\ \text{to}\ -2\ \text{V}, R_L = 100\ \Omega$ | | 25°C | 0.5 | 3 | | |
| | | | Full range | 0.25 | | | |
| r_i Input resistance | | | 25°C | 10^{12} | | Ω | |
| c_i Input capacitance | | | 25°C | 4 | | pF | |
| z_o Open-loop output impedance | $I_O = 0$ | | 25°C | 280 | | Ω | |
| CMRR Common-mode rejection ratio | $V_{IC} = V_{ICR\text{min}}, R_S = 50\ \Omega$ | | 25°C | 65 | 82 | dB | |
| | | | Full range | 65 | | | |
| k_{SVR} Supply-voltage rejection ratio ($\Delta V_{CC\pm}/\Delta V_{IO}$) | $V_{CC\pm} = \pm 5\ \text{V}\ \text{to}\ \pm 15\ \text{V}, R_S = 50\ \Omega$ | | 25°C | 75 | 93 | dB | |
| | | | Full range | 75 | | | |

† Full range is 0°C to 70°C.

NOTE 6: Typical values are based on the input offset voltage shift observed through 168 hours of operating life test at $T_A = 150^\circ\text{C}$ extrapolated to $T_A = 25^\circ\text{C}$ using the Arrhenius equation and assuming an activation energy of 0.96 eV.



TLE206x, TLE206xA, TLE206xB
EXCALIBUR JFET-INPUT HIGH-OUTPUT-DRIVE
μPOWER OPERATIONAL AMPLIFIERS

SLOS193B – FEBRUARY 1997 – REVISED MAY 2004

TLE2061C electrical characteristics at specified free-air temperature, $V_{CC\pm} = \pm 5\text{ V}$ (unless otherwise noted) (continued)

| PARAMETER | TEST CONDITIONS | T_A † | TLE2061C TLE2061AC TLE2061BC | | | UNIT |
|------------------------------------------------------------------------|---------------------|------------|------------------------------------|-----|-----|---------------|
| | | | MIN | TYP | MAX | |
| I_{CC} Supply current | $V_O = 0$, No load | 25°C | | 280 | 325 | μA |
| | | Full range | | | 350 | |
| ΔI_{CC} Supply-current change over operating temperature range | | Full range | | 29 | | μA |

† Full range is 0°C to 70°C.

TLE2061C operating characteristics at specified free-air temperature, $V_{CC\pm} = \pm 5\text{ V}$

| PARAMETER | TEST CONDITIONS | T_A † | TLE2061C TLE2061AC TLE2061BC | | | UNIT |
|---------------------------------------------------------|----------------------------------------------------------------------------------------------|------------|------------------------------------|--------|-----|------------------------------|
| | | | MIN | TYP | MAX | |
| SR Slew rate at unity gain (see Figure 1) | $R_L = 10\text{ k}\Omega$, $C_L = 100\text{ pF}$ | 25°C | 2.2 | 3.4 | | $\text{V}/\mu\text{s}$ |
| | | Full range | 2.1 | | | |
| V_n Equivalent input noise voltage (see Figure 2) | $f = 10\text{ Hz}$, $R_S = 20\ \Omega$ | 25°C | | 59 | 100 | $\text{nV}/\sqrt{\text{Hz}}$ |
| | $f = 1\text{ kHz}$, $R_S = 20\ \Omega$ | | | 43 | 60 | |
| $V_{N(PP)}$ Peak-to-peak equivalent input noise voltage | $f = 0.1\text{ Hz}$ to 10 Hz | 25°C | | 1.1 | | μV |
| I_n Equivalent input noise current | $f = 1\text{ kHz}$ | 25°C | | 1 | | $\text{fA}/\sqrt{\text{Hz}}$ |
| THD Total harmonic distortion | $A_{VD} = 2$, $f = 10\text{ kHz}$, $V_{O(PP)} = 2\text{ V}$, $R_L = 10\text{ k}\Omega$ | 25°C | | 0.025% | | |
| B_1 Unity-gain bandwidth (see Figure 3) | $R_L = 10\text{ k}\Omega$, $C_L = 100\text{ pF}$ | 25°C | | 1.8 | | MHz |
| | $R_L = 100\ \Omega$, $C_L = 100\text{ pF}$ | | | 1.3 | | |
| t_s Settling time | 0.1% | 25°C | | 5 | | μs |
| | 0.01% | | | 10 | | |
| B_{OM} Maximum output-swing bandwidth | $A_{VD} = 1$, $R_L = 10\text{ k}\Omega$ | 25°C | | 140 | | kHz |
| ϕ_m Phase margin at unity gain (see Figure 3) | $R_L = 10\text{ k}\Omega$, $C_L = 100\text{ pF}$ | 25°C | | 58° | | |
| | $R_L = 100\ \Omega$, $C_L = 100\text{ pF}$ | | | 75° | | |

† Full range is 0°C to 70°C.

TLE206x, TLE206xA, TLE206xB
EXCALIBUR JFET-INPUT HIGH-OUTPUT-DRIVE
μPOWER OPERATIONAL AMPLIFIERS

SLOS193B – FEBRUARY 1997 – REVISED MAY 2004

TLE2061C electrical characteristics at specified free-air temperature, $V_{CC\pm} = \pm 15$ V (unless otherwise noted)

| PARAMETER | | TEST CONDITIONS | T_A † | TLE2061C TLE2061AC TLE2061BC | | | UNIT | |
|-------------------------------------------------------------------------------|---------------------------------------------------------------------|----------------------------------------|------------|------------------------------------|----------|-----|------------------------------|-------------------------|
| | | | | MIN | TYP | MAX | | |
| V_{IO} Input offset voltage | TLE2061C | $V_{IC} = 0, R_S = 50 \text{ k}\Omega$ | 25°C | 0.6 | 3 | mV | | |
| | | | Full range | 3.9 | | | | |
| | | | 25°C | 0.5 | 1.5 | | | |
| | TLE2061AC | | Full range | 2.5 | | | | |
| | TLE2061BC | | 25°C | 0.3 | 0.5 | | | |
| | | | Full range | 1 | | | | |
| | | | Full range | 6 | | | $\mu\text{V}/^\circ\text{C}$ | |
| | αV_{IO} Temperature coefficient of input offset voltage | | | 25°C | 0.04 | | | $\mu\text{V}/\text{mo}$ |
| | Input offset voltage long-term drift (see Note 4) | | | 25°C | 2 | | | pA |
| I_{IO} Input offset current | | Full range | 1 | | nA | | | |
| I_{IB} Input bias current | | 25°C | 4 | | pA | | | |
| | | Full range | 3 | | nA | | | |
| V_{ICR} Common-mode input voltage range | | 25°C | -11 to 13 | -12 to 16 | V | | | |
| | | Full range | -11 to 13 | | V | | | |
| V_{OM+} Maximum positive peak output voltage swing | $R_L = 10 \text{ k}\Omega$ | 25°C | 13.2 | 13.7 | V | | | |
| | | Full range | 13 | | | | | |
| | $R_L = 600 \Omega$ | 25°C | 12.5 | 13.2 | | | | |
| | | Full range | 12 | | | | | |
| V_{OM-} Maximum negative peak output voltage swing | $R_L = 10 \text{ k}\Omega$ | 25°C | -13.2 | -13.7 | V | | | |
| | | Full range | -13 | | | | | |
| | $R_L = 600 \Omega$ | 25°C | -12.5 | -13 | | | | |
| | | Full range | -12 | | | | | |
| A_{VD} Large-signal differential voltage amplification | $V_O = \pm 10 \text{ V}, R_L = 10 \text{ k}\Omega$ | 25°C | 30 | 230 | V/mV | | | |
| | | Full range | 20 | | | | | |
| | $V_O = 0 \text{ to } 8 \text{ V}, R_L = 600 \Omega$ | 25°C | 25 | 100 | | | | |
| | | Full range | 10 | | | | | |
| | $V_O = 0 \text{ to } -8 \text{ V}, R_L = 600 \Omega$ | 25°C | 3 | 25 | | | | |
| | | Full range | 1 | | | | | |
| r_i Input resistance | | 25°C | 10^{12} | | Ω | | | |
| c_i Input capacitance | | 25°C | 4 | | pF | | | |
| z_o Open-loop output impedance | $I_O = 0$ | 25°C | 280 | | Ω | | | |
| CMRR Common-mode rejection ratio | $V_{IC} = V_{ICRmin}, R_S = 50 \Omega$ | 25°C | 72 | 90 | dB | | | |
| | | Full range | 70 | | | | | |
| k_{SVR} Supply-voltage rejection ratio ($\Delta V_{CC\pm}/\Delta V_{IO}$) | $V_{CC\pm} = \pm 5 \text{ V to } \pm 15 \text{ V}, R_S = 50 \Omega$ | 25°C | 75 | 93 | dB | | | |
| | | Full range | 75 | | | | | |

† Full range is 0°C to 70°C.

NOTE 4: Typical values are based on the input offset voltage shift observed through 168 hours of operating life test at $T_A = 150^\circ\text{C}$ extrapolated to $T_A = 25^\circ\text{C}$ using the Arrhenius equation and assuming an activation energy of 0.96 eV.



TLE206x, TLE206xA, TLE206xB
EXCALIBUR JFET-INPUT HIGH-OUTPUT-DRIVE
μPOWER OPERATIONAL AMPLIFIERS

SLOS193B – FEBRUARY 1997 – REVISED MAY 2004

TLE2061C electrical characteristics at specified free-air temperature, $V_{CC\pm} = \pm 15$ V (unless otherwise noted) (continued)

| PARAMETER | TEST CONDITIONS | T_A † | TLE2061C TLE2061AC TLE2061BC | | | UNIT |
|------------------------------------------------------------------------|---------------------|------------|------------------------------------|-----|---------|------|
| | | | MIN | TYP | MAX | |
| I_{CC} Supply current | $V_O = 0$, No load | 25°C | 290 | 350 | μA | |
| | | Full range | 375 | | | |
| ΔI_{CC} Supply-current change over operating temperature range | | Full range | 34 | | μA | |

† Full range is 0°C to 70°C.

TLE2061C operating characteristics at specified free-air temperature, $V_{CC\pm} = \pm 15$ V

| PARAMETER | TEST CONDITIONS | T_A † | TLE2061C TLE2061AC TLE2061BC | | | UNIT |
|---------------------------------------------------------|-----------------------------------------------------------------------|------------|------------------------------------|-----|----------------|------|
| | | | MIN | TYP | MAX | |
| SR Slew rate at unity gain (see Figure 1) | $R_L = 10$ k Ω , $C_L = 100$ pF | 25°C | 2.6 | 3.4 | $V/\mu s$ | |
| | | Full range | 2.5 | | | |
| V_n Equivalent input noise voltage (see Figure 2) | $f = 10$ Hz, $R_S = 20$ Ω | 25°C | 70 | 100 | nV/\sqrt{Hz} | |
| | $f = 1$ kHz, $R_S = 20$ Ω | | 40 | 60 | | |
| $V_{N(PP)}$ Peak-to-peak equivalent input noise voltage | $f = 0.1$ Hz to 10 Hz | 25°C | 1.1 | | μV | |
| I_n Equivalent input noise current | $f = 1$ kHz | 25°C | 1.1 | | fA/\sqrt{Hz} | |
| THD Total harmonic distortion | $A_{VD} = 2$, $V_{O(PP)} = 2$ V, $f = 10$ kHz, $R_L = 10$ k Ω | 25°C | 0.025% | | | |
| B_1 Unity-gain bandwidth (see Figure 3) | $R_L = 10$ k Ω , $C_L = 100$ pF | 25°C | 2 | | MHz | |
| | $R_L = 600$ Ω , $C_L = 100$ pF | | 1.5 | | | |
| t_s Settling time | 0.1% | 25°C | 5 | | μs | |
| | 0.01% | | 10 | | | |
| B_{OM} Maximum output-swing bandwidth | $A_{VD} = 1$, $R_L = 10$ k Ω | 25°C | 40 | | kHz | |
| ϕ_m Phase margin at unity gain (see Figure 3) | $R_L = 10$ k Ω , $C_L = 100$ pF | 25°C | 60° | | | |
| | $R_L = 600$ Ω , $C_L = 100$ pF | | 70° | | | |

† Full range is 0°C to 70°C.

TLE206x, TLE206xA, TLE206xB
EXCALIBUR JFET-INPUT HIGH-OUTPUT-DRIVE
μPOWER OPERATIONAL AMPLIFIERS

SLOS193B – FEBRUARY 1997 – REVISED MAY 2004

TLE2061I electrical characteristics at specified free-air temperature, $V_{CC\pm} = \pm 5\text{ V}$ (unless otherwise noted)

| PARAMETER | | TEST CONDITIONS | T_A † | TLE2061I, TLE2061AI TLE2061BI | | | UNIT | | |
|-----------------|---------------------------------------------------------------------|---------------------------------------------------------------------------|----------------|---------------------------------------------------|---------------|---------------|------|--|------------------------------|
| | | | | MIN | TYP | MAX | | | |
| V_{IO} | Input offset voltage | $V_{IC} = 0,$ $R_S = 50\ \Omega$ | 25°C | 0.8 | 3.1 | mV | | | |
| | | | Full range | | 4.4 | | | | |
| | | | 25°C | 0.6 | 2.6 | | | | |
| | | | Full range | | 3.9 | | | | |
| | | | 25°C | 0.5 | 1.9 | | | | |
| | | | Full range | | 2.7 | | | | |
| | | | α_{VIO} | Temperature coefficient of input offset voltage | Full range | | 6 | | $\mu\text{V}/^\circ\text{C}$ |
| | | | | Input offset voltage long-term drift (see Note 4) | 25°C | | 0.04 | | $\mu\text{V}/\text{mo}$ |
| | | | | | 25°C | | 1 | | pA |
| I_{IO} | Input offset current | Full range | | 2 | nA | | | | |
| I_{IB} | Input bias current | 25°C | 3 | | pA | | | | |
| | | Full range | | 4 | nA | | | | |
| V_{ICR} | Common-mode input voltage range | 25°C | -1.6 to 4 | -2 to 6 | V | | | | |
| | | Full range | -1.6 to 4 | | V | | | | |
| V_{OM+} | Maximum positive peak output voltage swing | $R_L = 10\ \text{k}\Omega$ | 25°C | 3.5 | 3.7 | V | | | |
| | | | Full range | 3.1 | | | | | |
| | | | 25°C | 2.5 | 3.1 | | | | |
| | | | Full range | 2 | | | | | |
| V_{OM-} | Maximum negative peak output voltage swing | $R_L = 10\ \text{k}\Omega$ | 25°C | -3.7 | -3.9 | V | | | |
| | | | Full range | -3.1 | | | | | |
| | | | 25°C | -2.5 | -2.7 | | | | |
| | | | Full range | -2 | | | | | |
| A_{VD} | Large-signal differential voltage amplification | $V_O = \pm 2.8\ \text{V},$ $R_L = 10\ \text{k}\Omega$ | 25°C | 15 | 80 | V/mV | | | |
| | | | Full range | 2 | | | | | |
| | | | 25°C | 0.75 | 45 | | | | |
| | | | Full range | 0.5 | | | | | |
| | | | 25°C | 0.5 | 3 | | | | |
| | | | Full range | 0.25 | | | | | |
| r_i | Input resistance | | 25°C | 10^{12} | Ω | | | | |
| c_i | Input capacitance | | 25°C | 4 | pF | | | | |
| z_o | Open-loop output impedance | $I_O = 0$ | 25°C | 280 | Ω | | | | |
| CMRR | Common-mode rejection ratio | $V_{IC} = V_{ICR\text{min}},$ $R_S = 50\ \Omega$ | 25°C | 65 | 82 | dB | | | |
| | | | Full range | 65 | | | | | |
| kSVR | Supply-voltage rejection ratio ($\Delta V_{CC\pm}/\Delta V_{IO}$) | $V_{CC\pm} = \pm 5\ \text{V to } \pm 15\ \text{V},$ $R_S = 50\ \Omega$ | 25°C | 75 | 93 | dB | | | |
| | | | Full range | 65 | | | | | |
| I_{CC} | Supply current | $V_O = 0,$ No load | 25°C | 280 | 325 | μA | | | |
| | | | Full range | | 350 | | | | |
| ΔI_{CC} | Supply-current change over operating temperature range | | Full range | 29 | μA | | | | |

† Full range is -40°C to 85°C.

NOTE 4: Typical values are based on the input offset voltage shift observed through 168 hours of operating life test at $T_A = 150^\circ\text{C}$ extrapolated to $T_A = 25^\circ\text{C}$ using the Arrhenius equation and assuming an activation energy of 0.96 eV.



TLE206x, TLE206xA, TLE206xB
EXCALIBUR JFET-INPUT HIGH-OUTPUT-DRIVE
μPOWER OPERATIONAL AMPLIFIERS

SLOS193B – FEBRUARY 1997 – REVISED MAY 2004

TLE20611 operating characteristics at specified free-air temperature, $V_{CC\pm} = \pm 5\text{ V}$

| PARAMETER | TEST CONDITIONS | T_A † | TLE20611 TLE2061AI TLE2061BI | | | UNIT |
|---------------------------------------------------------|----------------------------------------------------------------------------------------------|------------|------------------------------------|-----|------------------------|------------------------|
| | | | MIN | TYP | MAX | |
| SR Slew rate at unity gain (see Figure 1) | $R_L = 10\text{ k}\Omega$, $C_L = 100\text{ pF}$ | 25°C | 2.2 | 3.4 | | V/ μ s |
| | | Full range | 1.7 | | | |
| V_n Equivalent input noise voltage (see Figure 2) | $f = 10\text{ Hz}$, $R_S = 20\ \Omega$ | 25°C | | 59 | 100 | nV/ $\sqrt{\text{Hz}}$ |
| | $f = 1\text{ kHz}$, $R_S = 20\ \Omega$ | | | 43 | 60 | |
| $V_{N(PP)}$ Peak-to-peak equivalent input noise voltage | $f = 0.1\text{ Hz to }10\text{ Hz}$ | 25°C | 1.1 | | μ V | |
| I_n Equivalent input noise current | $f = 1\text{ kHz}$ | 25°C | 1 | | fA/ $\sqrt{\text{Hz}}$ | |
| THD Total harmonic distortion | $A_{VD} = 2$, $f = 10\text{ kHz}$, $V_{O(PP)} = 2\text{ V}$, $R_L = 10\text{ k}\Omega$ | 25°C | 0.025% | | | |
| B_1 Unity-gain bandwidth (see Figure 3) | $R_L = 10\text{ k}\Omega$, $C_L = 100\text{ pF}$ | 25°C | 1.8 | | MHz | |
| | $R_L = 100\ \Omega$, $C_L = 100\text{ pF}$ | | 1.3 | | | |
| t_s Settling time | 0.1% | 25°C | 5 | | μ s | |
| | 0.01% | | 10 | | | |
| B_{OM} Maximum output-swing bandwidth | $A_{VD} = 1$, $R_L = 10\text{ k}\Omega$ | 25°C | 140 | | kHz | |
| ϕ_m Phase margin at unity gain (see Figure 3) | $R_L = 10\text{ k}\Omega$, $C_L = 100\text{ pF}$ | 25°C | 58° | | | |
| | $R_L = 100\ \Omega$, $C_L = 100\text{ pF}$ | | 75° | | | |

† Full range is -40°C to 85°C .

TLE206x, TLE206xA, TLE206xB EXCALIBUR JFET-INPUT HIGH-OUTPUT-DRIVE μPOWER OPERATIONAL AMPLIFIERS

SLOS193B – FEBRUARY 1997 – REVISED MAY 2004

TLE2061I electrical characteristics at specified free-air temperature, $V_{CC\pm} = \pm 15\text{ V}$ (unless otherwise noted)

| PARAMETER | | TEST CONDITIONS | T_A † | TLE2061I, TLE2061AI TLE2061BI | | | UNIT |
|-----------------|---------------------------------------------------------------------|-----------------------------------------------------------------------------------|------------|----------------------------------|-------|------------------------------|-------------------------|
| | | | | MIN | TYP | MAX | |
| V_{IO} | Input offset voltage | | 25°C | TLE2061I | | 0.6 | 3 |
| | | | | Full range | | 4.3 | |
| | | | | TLE2061AI | | 0.5 | 1.5 |
| | | | | Full range | | 2.9 | |
| | | | | TLE2061BI | | 0.3 | 0.5 |
| | | | | Full range | | 1.3 | |
| α_{VIO} | Temperature coefficient of input offset voltage | $V_{IC} = 0,$ $R_S = 50\ \Omega$ | Full range | 6 | | $\mu\text{V}/^\circ\text{C}$ | |
| | Input offset voltage long-term drift (see Note 4) | | | 25°C | 0.04 | | $\mu\text{V}/\text{mo}$ |
| I_{IO} | Input offset current | | | 25°C | 2 | | pA |
| | | | | Full range | 3 | | nA |
| I_{IB} | Input bias current | | | 25°C | 4 | | pA |
| | | | | Full range | 5 | | nA |
| V_{ICR} | Common-mode input voltage range | 25°C | -11 to 13 | -12 to 16 | V | | |
| | | Full range | -11 to 13 | | V | | |
| V_{OM+} | Maximum positive peak output voltage swing | $R_L = 10\ \text{k}\Omega$ | 25°C | 13.2 | 13.7 | V | |
| | | | Full range | 13 | | | |
| | | $R_L = 600\ \Omega$ | 25°C | 12.5 | 13.2 | | |
| | | | Full range | 12 | | | |
| V_{OM-} | Maximum negative peak output voltage swing | $R_L = 10\ \text{k}\Omega$ | 25°C | -13.2 | -13.7 | V | |
| | | | Full range | -13 | | | |
| | | $R_L = 600\ \Omega$ | 25°C | -12.5 | -13 | | |
| | | | Full range | -12 | | | |
| A_{VD} | Large-signal differential voltage amplification | $V_O = \pm 10\ \text{V},$ $R_L = 10\ \text{k}\Omega$ | 25°C | 30 | 230 | V/mV | |
| | | | Full range | 20 | | | |
| | | $V_O = 0\ \text{to}\ 8\ \text{V},$ $R_L = 600\ \Omega$ | 25°C | 25 | 100 | | |
| | | | Full range | 10 | | | |
| | | $V_O = 0\ \text{to}\ -8\ \text{V},$ $R_L = 600\ \Omega$ | 25°C | 3 | 25 | | |
| | | | Full range | 01 | | | |
| r_i | Input resistance | | 25°C | 10^{12} | | Ω | |
| c_i | Input capacitance | | 25°C | 4 | | pF | |
| z_o | Open-loop output impedance | $I_O = 0$ | 25°C | 280 | | Ω | |
| CMRR | Common-mode rejection ratio | $V_{IC} = V_{ICR\text{min}},$ $R_S = 50\ \Omega$ | 25°C | 72 | 90 | dB | |
| | | | Full range | 65 | | | |
| k_{SVR} | Supply-voltage rejection ratio ($\Delta V_{CC\pm}/\Delta V_{IO}$) | $V_{CC\pm} = \pm 5\ \text{V}\ \text{to}\ \pm 15\ \text{V},$ $R_S = 50\ \Omega$ | 25°C | 75 | 93 | dB | |
| | | | Full range | 65 | | | |
| I_{CC} | Supply current | $V_O = 0,$ No load | 25°C | 290 | 350 | μA | |
| | | | Full range | 375 | | | |
| ΔI_{CC} | Supply-current change over operating temperature range | | Full range | 34 | | μA | |

† Full range is -40°C to 85°C .

NOTE 4: Typical values are based on the input offset voltage shift observed through 168 hours of operating life test at $T_A = 150^\circ\text{C}$ extrapolated to $T_A = 25^\circ\text{C}$ using the Arrhenius equation and assuming an activation energy of 0.96 eV.



TLE206x, TLE206xA, TLE206xB
EXCALIBUR JFET-INPUT HIGH-OUTPUT-DRIVE
μPOWER OPERATIONAL AMPLIFIERS

SLOS193B – FEBRUARY 1997 – REVISED MAY 2004

TLE2061I operating characteristics at specified free-air temperature, $V_{CC\pm} = \pm 15\text{ V}$

| PARAMETER | TEST CONDITIONS | T_A † | TLE2061I TLE2061AI TLE2061BI | | | UNIT |
|---------------------------------------------------------|----------------------------------------------------------------------------------------------|------------|------------------------------------|--------|-----|------------------------|
| | | | MIN | TYP | MAX | |
| SR Slew rate at unity gain (see Figure 1) | $R_L = 10\text{ k}\Omega$, $C_L = 100\text{ pF}$ | 25°C | 2.6 | 3.4 | | V/ μ s |
| | | Full range | 2.1 | | | |
| V_n Equivalent input noise voltage (see Figure 2) | $f = 10\text{ Hz}$, $R_S = 20\ \Omega$ | 25°C | | 70 | 100 | nV/ $\sqrt{\text{Hz}}$ |
| | $f = 1\text{ kHz}$, $R_S = 20\ \Omega$ | | | 40 | 60 | |
| $V_{N(PP)}$ Peak-to-peak equivalent input noise voltage | $f = 0.1\text{ Hz to }10\text{ Hz}$ | 25°C | | 1.1 | | μ V |
| I_n Equivalent input noise current | $f = 1\text{ kHz}$ | 25°C | | 1.1 | | fA/ $\sqrt{\text{Hz}}$ |
| THD Total harmonic distortion | $A_{VD} = 2$, $f = 10\text{ kHz}$, $V_{O(PP)} = 2\text{ V}$, $R_L = 10\text{ k}\Omega$ | 25°C | | 0.025% | | |
| B_1 Unity-gain bandwidth (see Figure 3) | $R_L = 10\text{ k}\Omega$, $C_L = 100\text{ pF}$ | 25°C | | 2 | | MHz |
| | $R_L = 600\ \Omega$, $C_L = 100\text{ pF}$ | | | 1.5 | | |
| t_s Settling time | 0.1% | 25°C | | 5 | | μ s |
| | 0.01% | | | 10 | | |
| B_{OM} Maximum output-swing bandwidth | $A_{VD} = 1$, $R_L = 10\text{ k}\Omega$ | 25°C | | 40 | | kHz |
| ϕ_m Phase margin at unity gain (see Figure 3) | $R_L = 10\text{ k}\Omega$, $C_L = 100\text{ pF}$ | 25°C | | 60° | | |
| | $R_L = 600\ \Omega$, $C_L = 100\text{ pF}$ | | | 70° | | |

† Full range is -40°C to 85°C .

TLE206x, TLE206xA, TLE206xB
EXCALIBUR JFET-INPUT HIGH-OUTPUT-DRIVE
μPOWER OPERATIONAL AMPLIFIERS

SLOS193B – FEBRUARY 1997 – REVISED MAY 2004

TLE2061M electrical characteristics at specified free-air temperature, $V_{CC\pm} = \pm 5\text{ V}$ (unless otherwise noted)

| PARAMETER | | TEST CONDITIONS | T_A † | TLE2061M TLE2061AM TLE2061BM | | | UNIT | |
|----------------|---------------------------------------------------|-----------------------------------------------------|---------------------|---------------------------------------------------------|------------|------------------------------|------|----|
| | | | | MIN | TYP | MAX | | |
| V_{IO} | Input offset voltage | $V_{IC} = 0, R_S = 50\ \Omega$ | 25°C | 0.8 | 3.1 | mV | | |
| | | | Full range | 6 | | | | |
| | | | 25°C | 0.6 | 2.6 | | | |
| | | | Full range | 4.6 | | | | |
| | | | 25°C | 0.5 | 1.9 | | | |
| | | | Full range | 3.1 | | | | |
| α_{VIO} | Temperature coefficient of input offset voltage | $V_{IC} = 0, R_S = 50\ \Omega$ | Full range | 6 | | $\mu\text{V}/^\circ\text{C}$ | | |
| | Input offset voltage long-term drift (see Note 4) | | 25°C | 0.04 | | $\mu\text{V}/\text{mo}$ | | |
| I_{IO} | Input offset current | | 25°C | 1 | | pA | | |
| | | | Full range | 15 | | nA | | |
| I_{IB} | Input bias current | | 25°C | 3 | | pA | | |
| | | | Full range | 30 | | nA | | |
| V_{ICR} | Common-mode input voltage range | 25°C | -1.6 to 4 | -2 to 6 | V | | | |
| | | Full range | -1.6 to 4 | | V | | | |
| V_{OM+} | Maximum positive peak output voltage swing | $R_L = 10\ \text{k}\Omega$ | 25°C | 3.5 | 3.7 | V | | |
| | | | Full range | 3 | | | | |
| | | | $R_L = 600\ \Omega$ | 25°C | 2.5 | | 3.6 | |
| | | | | Full range | 2 | | | |
| | | | $R_L = 100\ \Omega$ | 25°C | 2.5 | | 3.1 | |
| | | | | Full range | 2 | | | |
| V_{OM-} | Maximum negative peak output voltage swing | $R_L = 10\ \text{k}\Omega$ | 25°C | -3.5 | -3.9 | V | | |
| | | | Full range | -3 | | | | |
| | | FK and JG packages | $R_L = 600\ \Omega$ | 25°C | -2.5 | | -3.5 | |
| | | | | Full range | -2 | | | |
| | | D and P packages | $R_L = 100\ \Omega$ | 25°C | -2.5 | | -2.7 | |
| | | | | Full range | -2 | | | |
| AVD | Large-signal differential voltage amplification | $V_O = \pm 2.8\ \text{V}, R_L = 10\ \text{k}\Omega$ | 25°C | 15 | 80 | V/mV | | |
| | | | Full range | 2 | | | | |
| | | | FK and JG packages | $V_O = 0\ \text{to}\ 2.5\ \text{V}, R_L = 600\ \Omega$ | 25°C | | 1 | 65 |
| | | | | | Full range | | 0.5 | |
| | | | FK and JG packages | $V_O = 0\ \text{to}\ -2.5\ \text{V}, R_L = 600\ \Omega$ | 25°C | | 1 | 16 |
| | | | | | Full range | | 0.5 | |
| | | | D and P packages | $V_O = 0\ \text{to}\ 2\ \text{V}, R_L = 100\ \Omega$ | 25°C | | 0.75 | 45 |
| | | | | | Full range | | 0.5 | |
| | | | D and P packages | $V_O = 0\ \text{to}\ -2\ \text{V}, R_L = 100\ \Omega$ | 25°C | | 0.5 | 3 |
| | | | | | Full range | | 0.25 | |

† Full range is -55°C to 125°C .

NOTE 4: Typical values are based on the input offset voltage shift observed through 168 hours of operating life test at $T_A = 150^\circ\text{C}$ extrapolated to $T_A = 25^\circ\text{C}$ using the Arrhenius equation and assuming an activation energy of 0.96 eV.



TLE206x, TLE206xA, TLE206xB
EXCALIBUR JFET-INPUT HIGH-OUTPUT-DRIVE
μPOWER OPERATIONAL AMPLIFIERS

SLOS193B – FEBRUARY 1997 – REVISED MAY 2004

TLE2061M electrical characteristics at specified free-air temperature, $V_{CC\pm} = \pm 5\text{ V}$ (unless otherwise noted) (continued)

| PARAMETER | TEST CONDITIONS | T_A † | TLE2061M TLE2061AM TLE2061BM | | | UNIT |
|-------------------------------------------------------------------------------|--------------------------------------------------------------------------|------------|------------------------------------|-----|-----|------|
| | | | MIN | TYP | MAX | |
| r_i Input resistance | | 25°C | 10 ¹² | | | Ω |
| c_i Input capacitance | | 25°C | 4 | | | pF |
| z_o Open-loop output impedance | $I_O = 0$ | 25°C | 280 | | | Ω |
| CMRR Common-mode rejection ratio | $V_{IC} = V_{ICRmin}$, $R_S = 50\ \Omega$ | 25°C | 65 | 82 | | dB |
| | | Full range | 60 | | | |
| k_{SVR} Supply-voltage rejection ratio ($\Delta V_{CC\pm}/\Delta V_{IO}$) | $V_{CC\pm} = \pm 5\text{ V to } \pm 15\text{ V}$, $R_S = 50\ \Omega$ | 25°C | 75 | 93 | | dB |
| | | Full range | 65 | | | |
| I_{CC} Supply current | $V_O = 0$, No load | 25°C | 280 | 325 | | μA |
| | | Full range | | 350 | | |
| ΔI_{CC} Supply-current change over operating temperature range | | Full range | 39 | | | μA |

† Full range is –55°C to 125°C.

TLE2061M operating characteristics at specified free-air temperature, $V_{CC\pm} = \pm 5\text{ V}$, $T_A = 25^\circ\text{C}$

| PARAMETER | TEST CONDITIONS | TLE2061M TLE2061AM TLE2061BM | | | UNIT |
|---------------------------------------------------------|----------------------------------------------------------------------------------------------|------------------------------------|-----|-----|------------------------|
| | | MIN | TYP | MAX | |
| SR Slew rate at unity gain (see Figure 1) | $R_L = 10\text{ k}\Omega$, $C_L = 100\text{ pF}$ | 3.4 | | | V/μs |
| V_n Equivalent input noise voltage (see Figure 2) | $f = 10\text{ Hz}$, $R_S = 20\ \Omega$ | 59 | | | $nV/\sqrt{\text{Hz}}$ |
| | $f = 1\text{ kHz}$, $R_S = 20\ \Omega$ | 43 | | | |
| $V_{N(PP)}$ Peak-to-peak equivalent input noise voltage | $f = 0.1\text{ Hz to } 10\text{ Hz}$ | 1.1 | | | μV |
| I_n Equivalent input noise current | $f = 1\text{ kHz}$ | 1 | | | fA/ $\sqrt{\text{Hz}}$ |
| THD Total harmonic distortion | $A_{VD} = 2$, $f = 10\text{ kHz}$, $V_{O(PP)} = 2\text{ V}$, $R_L = 10\text{ k}\Omega$ | 0.025% | | | |
| B_1 Unity-gain bandwidth (see Figure 3) | $R_L = 10\text{ k}\Omega$, $C_L = 100\text{ pF}$ | 1.8 | | | MHz |
| | $R_L = 600\ \Omega$, $C_L = 100\text{ pF}$ | 1.3 | | | |
| t_s Settling time | 0.1% | 5 | | | μs |
| | 0.01% | 10 | | | |
| B_{OM} Maximum output-swing bandwidth | $A_{VD} = 1$, $R_L = 10\text{ k}\Omega$ | 140 | | | kHz |
| ϕ_m Phase margin at unity gain (see Figure 3) | $R_L = 10\text{ k}\Omega$, $C_L = 100\text{ pF}$ | 58° | | | |
| | $R_L = 600\ \Omega$, $C_L = 100\text{ pF}$ | 75° | | | |

TLE206x, TLE206xA, TLE206xB
EXCALIBUR JFET-INPUT HIGH-OUTPUT-DRIVE
μPOWER OPERATIONAL AMPLIFIERS

SLOS193B – FEBRUARY 1997 – REVISED MAY 2004

TLE2061M electrical characteristics at specified free-air temperature, $V_{CC\pm} = \pm 15\text{ V}$ (unless otherwise noted)

| PARAMETER | | TEST CONDITIONS | T_A † | TLE2061M ,TLE2061AM TLE2061BM | | | UNIT |
|----------------|---------------------------------------------------------------------|-----------------------------------------------------------------------------------|------------|----------------------------------|-------|------------------------------|------|
| | | | | MIN | TYP | MAX | |
| V_{IO} | Input offset voltage | | 25°C | TLE2061M | | 0.6 | 3 |
| | | | | Full range | | 6 | |
| | | | | TLE2061AM | | 0.5 | 1.5 |
| | | | | Full range | | 3.6 | |
| | | | | TLE2061BM | | 0.3 | 0.5 |
| | | | | Full range | | 1.7 | |
| α_{VIO} | Temperature coefficient of input offset voltage | $V_{IC} = 0,$ $R_S = 50\ \Omega$ | Full range | 6 | | $\mu\text{V}/^\circ\text{C}$ | |
| | Input offset voltage long-term drift (see Note 4) | | 25°C | 0.04 | | $\mu\text{V}/\text{mo}$ | |
| I_{IO} | Input offset current | | 25°C | 2 | | pA | |
| | | | Full range | 20 | | nA | |
| I_{IB} | Input bias current | | 25°C | 4 | | pA | |
| | | | Full range | 40 | | nA | |
| V_{ICR} | Common-mode input voltage range | 25°C | -11 to 13 | -12 to 16 | V | | |
| | | Full range | -11 to 13 | | V | | |
| V_{OM+} | Maximum positive peak output voltage swing | $R_L = 10\ \text{k}\Omega$ | 25°C | 13 | 13.7 | V | |
| | | | Full range | 12.5 | | | |
| | | $R_L = 600\ \Omega$ | 25°C | 12.5 | 13.2 | | |
| | | | Full range | 12 | | | |
| V_{OM-} | Maximum negative peak output voltage swing | $R_L = 10\ \text{k}\Omega$ | 25°C | -13 | -13.7 | V | |
| | | | Full range | -12.5 | | | |
| | | $R_L = 600\ \Omega$ | 25°C | -12.5 | -13 | | |
| | | | Full range | -12 | | | |
| A_{VD} | Large-signal differential voltage amplification | $V_O = \pm 10\ \text{V},$ $R_L = 10\ \text{k}\Omega$ | 25°C | 30 | 230 | V/mV | |
| | | | Full range | 20 | | | |
| | | $V_O = 0\ \text{to}\ 8\ \text{V},$ $R_L = 600\ \Omega$ | 25°C | 25 | 100 | | |
| | | | Full range | 7 | | | |
| | | $V_O = 0\ \text{to}\ -8\ \text{V},$ $R_L = 600\ \Omega$ | 25°C | 3 | 25 | | |
| | | | Full range | 1 | | | |
| r_i | Input resistance | | 25°C | 10^{12} | | Ω | |
| c_i | Input capacitance | | 25°C | 4 | | pF | |
| z_o | Open-loop output impedance | $I_O = 0$ | 25°C | 280 | | Ω | |
| CMRR | Common-mode rejection ratio | $V_{IC} = V_{ICR\text{min}},$ $R_S = 50\ \Omega$ | 25°C | 72 | 90 | dB | |
| | | | Full range | 65 | | | |
| k_{SVR} | Supply-voltage rejection ratio ($\Delta V_{CC\pm}/\Delta V_{IO}$) | $V_{CC\pm} = \pm 5\ \text{V}\ \text{to}\ \pm 15\ \text{V},$ $R_S = 50\ \Omega$ | 25°C | 75 | 93 | dB | |
| | | | Full range | 65 | | | |

† Full range is -55°C to 125°C .

NOTE 4: Typical values are based on the input offset voltage shift observed through 168 hours of operating life test at $T_A = 150^\circ\text{C}$ extrapolated to $T_A = 25^\circ\text{C}$ using the Arrhenius equation and assuming an activation energy of 0.96 eV.



TLE206x, TLE206xA, TLE206xB
EXCALIBUR JFET-INPUT HIGH-OUTPUT-DRIVE
μPOWER OPERATIONAL AMPLIFIERS

SLOS193B – FEBRUARY 1997 – REVISED MAY 2004

TLE2061M electrical characteristics at specified free-air temperature, $V_{CC\pm} = \pm 15$ V (unless otherwise noted) (continue)

| PARAMETER | TEST CONDITIONS | T_A † | TLE2061M ,TLE2061AM TLE2061BM | | | UNIT |
|------------------------------------------------------------------------|---------------------|------------|----------------------------------|-----|-----|------|
| | | | MIN | TYP | MAX | |
| I_{CC} Supply current | $V_O = 0$, No load | 25°C | 290 | | 350 | μA |
| | | Full range | | | 375 | |
| ΔI_{CC} Supply-current change over operating temperature range | | Full range | 46 | | | μA |

† Full range is –55°C to 125°C.

TLE2061M operating characteristics at specified free-air temperature, $V_{CC\pm} = \pm 15$ V

| PARAMETER | TEST CONDITIONS | T_A † | TLE2061M TLE2061AM TLE2061BM | | | UNIT |
|---------------------------------------------------------|------------------------------------------------------------------|------------|------------------------------------|-----|-----|--------|
| | | | MIN | TYP | MAX | |
| SR Slew rate at unity gain (see Figure 1) | $R_L = 10$ kΩ, $C_L = 100$ pF | 25°C | 2 | 3.4 | | V/μs |
| | | Full range | 1.8 | | | |
| V_n Equivalent input noise voltage (see Figure 2) | $f = 10$ Hz, $R_S = 20$ Ω | 25°C | 70 | | | nV/√Hz |
| | $f = 1$ kHz, $R_S = 20$ Ω | 25°C | 40 | | | |
| $V_{N(PP)}$ Peak-to-peak equivalent input noise voltage | $f = 0.1$ Hz to 10 Hz | 25°C | 1.1 | | | μV |
| I_n Equivalent input noise current | $f = 1$ kHz | 25°C | 1.1 | | | fA/√Hz |
| THD Total harmonic distortion | $A_{VD} = 2$, $f = 10$ kHz, $V_{O(PP)} = 2$ V, $R_L = 10$ kΩ | 25°C | 0.025% | | | |
| B_1 Unity-gain bandwidth (see Figure 3) | $R_L = 10$ kΩ, $C_L = 100$ pF | 25°C | 2 | | | MHz |
| | $R_L = 600$ Ω, $C_L = 100$ pF | 25°C | 1.5 | | | |
| t_s Settling time | 0.1% | 25°C | 5 | | | μs |
| | 0.01% | 25°C | 10 | | | |
| B_{OM} Maximum output-swing bandwidth | $A_{VD} = 1$, $R_L = 10$ kΩ | 25°C | 40 | | | kHz |
| ϕ_m Phase margin at unity gain (see Figure 3) | $R_L = 10$ kΩ, $C_L = 100$ pF | 25°C | 60° | | | |
| | $R_L = 600$ Ω, $C_L = 100$ pF | 25°C | 70° | | | |

† Full range is –55°C to 125°C.

TLE206x, TLE206xA, TLE206xB EXCALIBUR JFET-INPUT HIGH-OUTPUT-DRIVE μPOWER OPERATIONAL AMPLIFIERS

SLOS193B – FEBRUARY 1997 – REVISED MAY 2004

TLE2061Y electrical characteristics at $V_{CC\pm} = \pm 15\text{ V}$, $T_A = 25^\circ\text{C}$ (unless otherwise noted)

| PARAMETER | TEST CONDITIONS | TLE2061Y | | | UNIT |
|----------------------------------------------------------------------------|------------------------------------------------------------------------------------|-----------------|-----------------|-----|-------------------------|
| | | MIN | TYP | MAX | |
| V_{IO} Input offset voltage | $V_{IC} = 0$, $R_S = 50\ \Omega$ | | 0.6 | 3 | mV |
| αV_{IO} Input offset voltage long-term drift (see Note 4) | | | 0.04 | | $\mu\text{V}/\text{mo}$ |
| I_{IO} Input offset current | | | 2 | | pA |
| I_{IB} Input bias current | | | 4 | | pA |
| V_{ICR} Common-mode input voltage range | | -11 to 13 | -12 to 16 | | V |
| V_{OM+} Maximum positive peak output voltage swing | $R_L = 10\ \text{k}\Omega$ | 13.2 | 13.7 | | V |
| | $R_L = 600\ \Omega$ | 12.5 | 13.2 | | |
| V_{OM-} Maximum negative peak output voltage swing | $R_L = 10\ \text{k}\Omega$ | -13.2 | -13.7 | | V |
| | $R_L = 600\ \Omega$ | -12.5 | -13 | | |
| A_{VD} Large-signal differential voltage amplification | $V_O = \pm 10\ \text{V}$, $R_L = 10\ \text{k}\Omega$ | 30 | 230 | | V/mV |
| | $V_O = 0\ \text{to}\ 8\ \text{V}$, $R_L = 600\ \Omega$ | 25 | 100 | | |
| | $V_O = 0\ \text{to}\ -8\ \text{V}$, $R_L = 600\ \Omega$ | 3 | 25 | | |
| r_i Input resistance | | | 10^{12} | | Ω |
| c_i Input capacitance | | | 4 | | pF |
| z_o Open-loop output impedance | $I_O = 0$ | | 280 | | Ω |
| CMRR Common-mode rejection ratio | $R_S = 50\ \Omega$, $V_{IC} = V_{ICR\text{min}}$ | 72 | 90 | | dB |
| k_{SVR} Supply-voltage rejection ratio ($\Delta V_{CC}/\Delta V_{IO}$) | $V_{CC\pm} = \pm 5\ \text{V}\ \text{to}\ \pm 15\ \text{V}$, $R_S = 50\ \Omega$ | 75 | 93 | | dB |
| I_{CC} Supply current | $V_O = 0$, No load | | 290 | 350 | μA |

NOTE 4: Typical values are based on the input offset voltage shift observed through 168 hours of operating life test at $T_A = 150^\circ\text{C}$ extrapolated to $T_A = 25^\circ\text{C}$ using the Arrhenius equation and assuming an activation energy of 0.96 eV.

TLE2061Y operating characteristics at $V_{CC\pm} = \pm 15\ \text{V}$, $T_A = 25^\circ\text{C}$

| PARAMETER | TEST CONDITIONS | TLE2061Y | | | UNIT |
|---------------------------------------------------------|-------------------------------------------------------------------------------------------------|----------|--------|-----|------------------------|
| | | MIN | TYP | MAX | |
| SR Slew rate at unity gain (see Figure 1) | $R_L = 10\ \text{k}\Omega$, $C_L = 100\ \text{pF}$ | 2.6 | 3.4 | | V/ μs |
| V_n Equivalent input noise voltage (see Figure 2) | $f = 10\ \text{Hz}$, $R_S = 20\ \Omega$ | | 70 | | nV/ $\sqrt{\text{Hz}}$ |
| | $f = 1\ \text{kHz}$, $R_S = 20\ \Omega$ | | 40 | | |
| $V_{N(PP)}$ Peak-to-peak equivalent input noise voltage | $f = 0.1\ \text{Hz}\ \text{to}\ 10\ \text{Hz}$ | | 1.1 | | μV |
| I_n Equivalent input noise current | $f = 1\ \text{Hz}$ | | 1.1 | | fA/ $\sqrt{\text{Hz}}$ |
| THD Total harmonic distortion | $A_{VD} = 2$, $f = 10\ \text{kHz}$, $V_{O(PP)} = 2\ \text{V}$, $R_L = 10\ \text{k}\Omega$ | | 0.025% | | |
| B_1 Unity-gain bandwidth (see Figure 3) | $R_L = 10\ \text{k}\Omega$, $C_L = 100\ \text{pF}$ | | 2 | | MHz |
| | $R_L = 600\ \Omega$, $C_L = 100\ \text{pF}$ | | 1.5 | | |
| t_s Settling time | 0.1% | | 5 | | μs |
| | 0.01% | | 10 | | |
| BOM Maximum output-swing bandwidth | $A_{VD} = 1$, $R_L = 10\ \text{k}\Omega$ | | 40 | | kHz |
| ϕ_m Phase margin at unity gain (see Figure 3) | $R_L = 10\ \text{k}\Omega$, $C_L = 100\ \text{pF}$ | | 60° | | |
| | $R_L = 600\ \Omega$, $C_L = 100\ \text{pF}$ | | 70° | | |



TLE206x, TLE206xA, TLE206xB
EXCALIBUR JFET-INPUT HIGH-OUTPUT-DRIVE
μPOWER OPERATIONAL AMPLIFIERS

SLOS193B – FEBRUARY 1997 – REVISED MAY 2004

TLE2062C electrical characteristics at specified free-air temperature, $V_{CC\pm} = \pm 5\text{ V}$ (unless otherwise noted)

| PARAMETER | | TEST CONDITIONS | T_A^\dagger | TLE2062C TLE2062AC TLE2062BC | | | UNIT |
|----------------|---------------------------------------------------------------------|---------------------------------------------------------------------------|---------------|------------------------------------|---------|------------------------------|------|
| | | | | MIN | TYP | MAX | |
| V_{IO} | Input offset voltage | $V_{IC} = 0,$ $R_S = 50\ \Omega$ | 25°C | 1 | 5 | mV | |
| | | | Full range | 5.9 | | | |
| | | | 25°C | 0.9 | 4 | | |
| | | | Full range | 4.9 | | | |
| | | | 25°C | 0.7 | 3 | | |
| | | | Full range | 3.9 | | | |
| α_{VIO} | Temperature coefficient of input offset voltage | $V_{IC} = 0,$ $R_S = 50\ \Omega$ | Full range | 6 | | $\mu\text{V}/^\circ\text{C}$ | |
| | Input offset voltage long-term drift (see Note 4) | | 25°C | 0.04 | | $\mu\text{V}/\text{mo}$ | |
| I_{IO} | Input offset current | | 25°C | 1 | | pA | |
| | | | Full range | 0.8 | | nA | |
| I_{IB} | Input bias current | | 25°C | 3 | | pA | |
| | | | Full range | 2 | | nA | |
| V_{ICR} | Common-mode input voltage range | | 25°C | -1.6 to 4 | -2 to 6 | V | |
| | | | Full range | -1.6 to 4 | | V | |
| V_{OM+} | Maximum positive peak output voltage swing | $R_L = 10\ \text{k}\Omega$ | 25°C | 3.5 | 3.7 | V | |
| | | | Full range | 3.3 | | | |
| | | | 25°C | 2.5 | 3.1 | | |
| | | | Full range | 2 | | | |
| V_{OM-} | Maximum negative peak output voltage swing | $R_L = 10\ \text{k}\Omega$ | 25°C | -3.7 | -3.9 | V | |
| | | | Full range | -3.3 | | | |
| | | | 25°C | -2.5 | -2.7 | | |
| | | | Full range | -2 | | | |
| A_{VD} | Large-signal differential voltage amplification | $V_O = \pm 2.8\ \text{V},$ $R_L = 10\ \text{k}\Omega$ | 25°C | 15 | 80 | V/mV | |
| | | | Full range | 2 | | | |
| | | | 25°C | 0.75 | 45 | | |
| | | | Full range | 0.5 | | | |
| | | | 25°C | 0.5 | 3 | | |
| | | | Full range | 0.25 | | | |
| r_i | Input resistance | | 25°C | 10^{12} | | Ω | |
| c_i | Input capacitance | | 25°C | 4 | | pF | |
| z_o | Open-loop output impedance | $I_O = 0$ | 25°C | 560 | | Ω | |
| CMRR | Common-mode rejection ratio | $V_{IC} = V_{ICR\text{min}},$ $R_S = 50\ \Omega$ | 25°C | 65 | 82 | dB | |
| | | | Full range | 65 | | | |
| k_{SVR} | Supply-voltage rejection ratio ($\Delta V_{CC\pm}/\Delta V_{IO}$) | $V_{CC\pm} = \pm 5\ \text{V to } \pm 15\ \text{V},$ $R_S = 50\ \Omega$ | 25°C | 75 | 93 | dB | |
| | | | Full range | 75 | | | |

† Full range is 0°C to 70°C.

NOTE 4: Typical values are based on the input offset voltage shift observed through 168 hours of operating life test at $T_A = 150^\circ\text{C}$ extrapolated to $T_A = 25^\circ\text{C}$ using the Arrhenius equation and assuming an activation energy of 0.96 eV.



TLE206x, TLE206xA, TLE206xB
EXCALIBUR JFET-INPUT HIGH-OUTPUT-DRIVE
μPOWER OPERATIONAL AMPLIFIERS

SLOS193B – FEBRUARY 1997 – REVISED MAY 2004

TLE2062C electrical characteristics at specified free-air temperature, $V_{CC\pm} = \pm 5$ V (unless otherwise noted) (continued)

| PARAMETER | TEST CONDITIONS | T_A † | TLE2062C TLE2062AC TLE2062BC | | | UNIT |
|------------------------------------------------------------------------|---------------------|------------|------------------------------------|-----|-----|------|
| | | | MIN | TYP | MAX | |
| I_{CC} Supply current | $V_O = 0$, No load | 25°C | | 560 | 620 | μA |
| | | Full range | | | 635 | |
| ΔI_{CC} Supply-current change over operating temperature range | | Full range | | 26 | | μA |

† Full range is 0°C to 70°C.

TLE2062C operating characteristics at specified free-air temperature, $V_{CC\pm} = \pm 5$ V

| PARAMETER | TEST CONDITIONS | T_A † | TLE2062C TLE2062AC TLE2062BC | | | UNIT |
|---------------------------------------------------------|------------------------------------------------------------------|------------|------------------------------------|--------|-----|--------|
| | | | MIN | TYP | MAX | |
| SR Slew rate at unity gain (see Figure 1) | $R_L = 10$ kΩ, $C_L = 100$ pF | 25°C | 2.2 | 3.4 | | V/μs |
| | | Full range | 2.1 | | | |
| V_n Equivalent input noise voltage (see Figure 2) | $f = 10$ Hz, $R_S = 20$ Ω | 25°C | | 59 | 100 | nV/√Hz |
| | $f = 1$ kHz, $R_S = 20$ Ω | 25°C | | 43 | 60 | |
| $V_{N(PP)}$ Peak-to-peak equivalent input noise voltage | $f = 0.1$ Hz to 10 Hz | 25°C | | 1.1 | | μV |
| I_n Equivalent input noise current | $f = 1$ kHz | 25°C | | 1 | | fA/√Hz |
| THD Total harmonic distortion | $V_{O(PP)} = 2$ V, $R_L = 10$ kΩ, $A_{VD} = 2$, $f = 10$ kHz | 25°C | | 0.025% | | |
| B_1 Unity-gain bandwidth (see Figure 3) | $R_L = 10$ kΩ, $C_L = 100$ pF | 25°C | | 1.8 | | MHz |
| | $R_L = 100$ Ω, $C_L = 100$ pF | 25°C | | 1.3 | | |
| Settling time | 0.1% | 25°C | | 5 | | μs |
| | 0.01% | 25°C | | 10 | | |
| BOM Maximum output-swing bandwidth | $A_{VD} = 1$, $R_L = 10$ kΩ | 25°C | | 140 | | kHz |
| ϕ_m Phase margin at unity gain (see Figure 3) | $R_L = 10$ kΩ, $C_L = 100$ pF | 25°C | | 58° | | |
| | $R_L = 100$ Ω, $C_L = 100$ pF | 25°C | | 75° | | |

† Full range is 0°C to 70°C.



TLE206x, TLE206xA, TLE206xB
EXCALIBUR JFET-INPUT HIGH-OUTPUT-DRIVE
μPOWER OPERATIONAL AMPLIFIERS

SLOS193B – FEBRUARY 1997 – REVISED MAY 2004

TLE2062C electrical characteristics at specified free-air temperature, $V_{CC\pm} = \pm 15\text{ V}$ (unless otherwise noted)

| PARAMETER | | TEST CONDITIONS | T_A † | TLE2062C TLE2062AC TLE2062BC | | | UNIT | |
|-------------------------------------------------------------------------------|------------------------------------------------------------------------------------|--------------------------------------|------------|------------------------------------|----------|-----|------|------------------------------|
| | | | | MIN | TYP | MAX | | |
| V_{IO} Input offset voltage | TLE2062C | $V_{IC} = 0, \quad R_S = 50\ \Omega$ | 25°C | 0.9 | 4 | mV | | |
| | | | Full range | | 4.9 | | | |
| | TLE2062AC | | 25°C | 0.8 | 2 | | | |
| | | | Full range | | 2.9 | | | |
| | TLE2062BC | | 25°C | 0.5 | 1 | | | |
| | | | Full range | | 1.9 | | | |
| | αV_{IO} Temperature coefficient of input offset voltage | | | Full range | 6 | | | $\mu\text{V}/^\circ\text{C}$ |
| | Input offset voltage long-term drift (see Note 4) | | | 25°C | 0.04 | | | $\mu\text{V}/\text{mo}$ |
| I_{IO} Input offset current | | 25°C | 2 | | pA | | | |
| | Full range | | | 1 | nA | | | |
| I_{IB} Input bias current | | 25°C | 4 | | pA | | | |
| | Full range | | | 3 | nA | | | |
| V_{ICR} Common-mode input voltage range | | 25°C | -11 to 13 | -12 to 16 | V | | | |
| | Full range | | -11 to 13 | | V | | | |
| V_{OM+} Maximum positive peak output voltage swing | $R_L = 10\ \text{k}\Omega$ | 25°C | 13.2 | 13.7 | V | | | |
| | | Full range | 13 | | | | | |
| | $R_L = 600\ \Omega$ | 25°C | 12.5 | 13.2 | | | | |
| | | Full range | 12 | | | | | |
| V_{OM-} Maximum negative peak output voltage swing | $R_L = 10\ \text{k}\Omega$ | 25°C | -13.2 | -13.7 | V | | | |
| | | Full range | -13 | | | | | |
| | $R_L = 600\ \Omega$ | 25°C | -12.5 | -13 | | | | |
| | | Full range | -12 | | | | | |
| A_{VD} Large-signal differential voltage amplification | $V_O = \pm 10\ \text{V}, \quad R_L = 10\ \text{k}\Omega$ | 25°C | 30 | 230 | V/mV | | | |
| | | Full range | 20 | | | | | |
| | $V_O = 0\ \text{to}\ 8\ \text{V}, \quad R_L = 600\ \Omega$ | 25°C | 25 | 100 | | | | |
| | | Full range | 10 | | | | | |
| | $V_O = 0\ \text{to}\ -8\ \text{V}, \quad R_L = 600\ \Omega$ | 25°C | 3 | 25 | | | | |
| | | Full range | 1 | | | | | |
| r_i Input resistance | | 25°C | | 10^{12} | Ω | | | |
| c_i Input capacitance | | 25°C | | 4 | pF | | | |
| z_o Open-loop output impedance | $I_O = 0$ | 25°C | | 560 | Ω | | | |
| CMRR Common-mode rejection ratio | $V_{IC} = V_{ICR\text{min}}, \quad R_S = 50\ \Omega$ | 25°C | 72 | 90 | dB | | | |
| | | Full range | 70 | | | | | |
| k_{SVR} Supply-voltage rejection ratio ($\Delta V_{CC\pm}/\Delta V_{IO}$) | $V_{CC\pm} = \pm 5\ \text{V}\ \text{to}\ \pm 15\ \text{V}, \quad R_S = 50\ \Omega$ | 25°C | 75 | 93 | dB | | | |
| | | Full range | 75 | | | | | |

† Full range is 0°C to 70°C.

NOTE 4: Typical values are based on the input offset voltage shift observed through 168 hours of operating life test at $T_A = 150^\circ\text{C}$ extrapolated to $T_A = 25^\circ\text{C}$ using the Arrhenius equation and assuming an activation energy of 0.96 eV.



TLE206x, TLE206xA, TLE206xB
EXCALIBUR JFET-INPUT HIGH-OUTPUT-DRIVE
μPOWER OPERATIONAL AMPLIFIERS

SLOS193B – FEBRUARY 1997 – REVISED MAY 2004

TLE2062C electrical characteristics at specified free-air temperature, $V_{CC\pm} = \pm 15$ V (unless otherwise noted) (continued)

| PARAMETER | TEST CONDITIONS | T_A † | TLE2062C TLE2062AC TLE2062BC | | | UNIT |
|------------------------------------------------------------------------|----------------------|------------|------------------------------------|-----|-----|------|
| | | | MIN | TYP | MAX | |
| I_{CC} Supply current | $V_O = 0$ V, No load | 25°C | | 625 | 690 | μA |
| | | Full range | | 715 | | |
| ΔI_{CC} Supply-current change over operating temperature range | | Full range | | 36 | | μA |

† Full range is 0°C to 70°C.

TLE2062C operating characteristics at specified free-air temperature, $V_{CC\pm} = \pm 15$ V

| PARAMETER | TEST CONDITIONS | T_A † | TLE2062C TLE2062AC TLE2062BC | | | UNIT |
|---------------------------------------------------------|---------------------------------------------------------------|------------|------------------------------------|-----|-----|--------|
| | | | MIN | TYP | MAX | |
| SR Slew rate at unity gain (see Figure 1) | $R_L = 10$ kΩ, $C_L = 100$ pF | 25°C | 2.6 | 3.4 | | V/μs |
| | | Full range | 2.5 | | | |
| V_n Equivalent input noise voltage (see Figure 2) | $f = 10$ Hz, $R_S = 20$ Ω | 25°C | | 70 | 100 | nV/√Hz |
| | $f = 1$ kHz, $R_S = 20$ Ω | 25°C | | 40 | 60 | |
| $V_{N(PP)}$ Peak-to-peak equivalent input noise voltage | $f = 0.1$ Hz to 10 Hz | 25°C | | 1.1 | | μV |
| I_n Equivalent input noise current | $f = 1$ kHz | 25°C | | 1.1 | | fA/√Hz |
| THD Total harmonic distortion | $V_{O(PP)} = 2$ V, $R_L = 10$ kΩ, $A_{VD} = 2$, $f = 10$ kHz | 25°C | 0.025% | | | |
| B_1 Unity-gain bandwidth (see Figure 3) | $R_L = 10$ kΩ, $C_L = 10$ pF | 25°C | 2 | | | MHz |
| | $R_L = 600$ Ω, $C_L = 100$ pF | 25°C | 1.5 | | | |
| Settling time | 0.1% | 25°C | 5 | | | μs |
| | 0.01% | 25°C | 10 | | | |
| B_{OM} Maximum output-swing bandwidth | $A_{VD} = 1$, $R_L = 10$ kΩ | 25°C | 40 | | | kHz |
| ϕ_m Phase margin at unity gain (see Figure 3) | $R_L = 10$ kΩ, $C_L = 100$ pF | 25°C | 60° | | | |
| | $R_L = 600$ Ω, $C_L = 100$ pF | 25°C | 70° | | | |

† Full range is 0°C to 70°C.



TLE206x, TLE206xA, TLE206xB
EXCALIBUR JFET-INPUT HIGH-OUTPUT-DRIVE
μPOWER OPERATIONAL AMPLIFIERS

SLOS193B – FEBRUARY 1997 – REVISED MAY 2004

TLE2062I electrical characteristics at specified free-air temperature, $V_{CC\pm} = \pm 5\text{ V}$ (unless otherwise noted)

| PARAMETER | | TEST CONDITIONS | T_A † | TLE2062I TLE2062AI TLE2062BI | | | UNIT |
|----------------|---------------------------------------------------------------------|------------------------------------------------------------------------------|------------|------------------------------------|------|------------------------------|------|
| | | | | MIN | TYP | MAX | |
| V_{IO} | Input offset voltage | $V_{IC} = 0, R_S = 50\ \Omega$ | 25°C | 1 | 5 | mV | |
| | | | Full range | 6.3 | | | |
| | | | 25°C | 0.9 | 4 | | |
| | | | Full range | 5.3 | | | |
| | | | 25°C | 0.7 | 3 | | |
| | | | Full range | 4.3 | | | |
| α_{VIO} | Temperature coefficient of input offset voltage | $V_{IC} = 0, R_S = 50\ \Omega$ | Full range | 6 | | $\mu\text{V}/^\circ\text{C}$ | |
| | Input offset voltage long-term drift (see Note 4) | | 25°C | 0.04 | | $\mu\text{V}/\text{mo}$ | |
| I_{IO} | Input offset current | | 25°C | 1 | | pA | |
| | | | Full range | 2 | | nA | |
| I_{IB} | Input bias current | | 25°C | 3 | | pA | |
| | | | Full range | 4 | | nA | |
| V_{ICR} | Common-mode input voltage range | 25°C | -1.6 to 4 | -2 to 6 | V | | |
| | | Full range | -1.6 to 4 | | V | | |
| V_{OM+} | Maximum positive peak output voltage swing | $R_L = 10\ \text{k}\Omega$ | 25°C | 3.5 | 3.7 | V | |
| | | | Full range | 3.1 | | | |
| | | $R_L = 100\ \Omega$ | 25°C | 2.5 | 3.1 | | |
| | | | Full range | 2 | | | |
| V_{OM-} | Maximum negative peak output voltage swing | $R_L = 10\ \text{k}\Omega$ | 25°C | -3.7 | -3.9 | V | |
| | | | Full range | -3.1 | | | |
| | | $R_L = 100\ \Omega$ | 25°C | -2.5 | -2.7 | | |
| | | | Full range | -2 | | | |
| A_{VD} | Large-signal differential voltage amplification | $V_O = \pm 2.8\ \text{V}, R_L = 10\ \text{k}\Omega$ | 25°C | 15 | 80 | V/mV | |
| | | | Full range | 2 | | | |
| | | $V_O = 0\ \text{to}\ 2\ \text{V}, R_L = 100\ \Omega$ | 25°C | 0.75 | 45 | | |
| | | | Full range | 0.5 | | | |
| | | $V_O = 0\ \text{to}\ -2\ \text{V}, R_L = 100\ \Omega$ | 25°C | 0.5 | 3 | | |
| | | | Full range | 0.25 | | | |
| r_i | Input resistance | | 25°C | 10^{12} | | Ω | |
| c_i | Input capacitance | | 25°C | 4 | | pF | |
| z_o | Open-loop output impedance | $I_O = 0$ | 25°C | 560 | | Ω | |
| CMRR | Common-mode rejection ratio | $V_{IC} = V_{ICRmin}, R_S = 50\ \Omega$ | 25°C | 65 | 82 | dB | |
| | | | Full range | 65 | | | |
| k_{SVR} | Supply-voltage rejection ratio ($\Delta V_{CC\pm}/\Delta V_{IO}$) | $V_{CC\pm} = \pm 5\ \text{V}\ \text{to}\ \pm 15\ \text{V}, R_S = 50\ \Omega$ | 25°C | 75 | 93 | dB | |
| | | | Full range | 65 | | | |

† Full range is -40°C to 85°C .

NOTE 4: Typical values are based on the input offset voltage shift observed through 168 hours of operating life test at $T_A = 150^\circ\text{C}$ extrapolated to $T_A = 25^\circ\text{C}$ using the Arrhenius equation and assuming an activation energy of 0.96 eV.



TLE206x, TLE206xA, TLE206xB
EXCALIBUR JFET-INPUT HIGH-OUTPUT-DRIVE
μPOWER OPERATIONAL AMPLIFIERS

SLOS193B – FEBRUARY 1997 – REVISED MAY 2004

TLE2062I electrical characteristics at specified free-air temperature, $V_{CC\pm} = \pm 5\text{ V}$ (unless otherwise noted) (continued)

| PARAMETER | TEST CONDITIONS | T_A^\dagger | TLE2062I TLE2062AI TLE2062BI | | | UNIT |
|------------------------------------------------------------------------|---------------------|---------------|------------------------------------|-----|-----|---------------|
| | | | MIN | TYP | MAX | |
| I_{CC} Supply current | $V_O = 0$, No load | 25°C | | 560 | 620 | μA |
| | | Full range | | | 640 | |
| ΔI_{CC} Supply-current change over operating temperature range | | Full range | | 54 | | μA |

† Full range is -40°C to 85°C .

TLE2062I operating characteristics at specified free-air temperature, $V_{CC\pm} = \pm 5\text{ V}$

| PARAMETER | TEST CONDITIONS | T_A^\dagger | TLE2062I TLE2062AI TLE2062BI | | | UNIT |
|---------------------------------------------------------|----------------------------------------------------------------------------------------------|---------------|------------------------------------|--------|-----|------------------------------|
| | | | MIN | TYP | MAX | |
| SR Slew rate at unity gain (see Figure 1) | $R_L = 10\text{ k}\Omega$, $C_L = 100\text{ pF}$ | 25°C | 2.2 | 3.4 | | $\text{V}/\mu\text{s}$ |
| | | Full range | 1.7 | | | |
| V_n Equivalent input noise voltage (see Figure 2) | $f = 10\text{ Hz}$, $R_S = 20\ \Omega$ | 25°C | | 59 | 100 | $\text{nV}/\sqrt{\text{Hz}}$ |
| | $f = 1\text{ kHz}$, $R_S = 20\ \Omega$ | 25°C | | 43 | 60 | |
| $V_{N(PP)}$ Peak-to-peak equivalent input noise voltage | $f = 0.1\text{ Hz}$ to 10 Hz | 25°C | | 1.1 | | μV |
| I_n Equivalent input noise current | $f = 1\text{ kHz}$ | 25°C | | 1 | | $\text{fA}/\sqrt{\text{Hz}}$ |
| THD Total harmonic distortion | $V_{O(PP)} = 2\text{ V}$, $R_L = 10\text{ k}\Omega$, $A_{VD} = 2$, $f = 10\text{ kHz}$ | 25°C | | 0.025% | | |
| B_1 Unity-gain bandwidth (see Figure 3) | $R_L = 10\text{ k}\Omega$, $C_L = 100\text{ pF}$ | 25°C | | 1.8 | | MHz |
| | $R_L = 100\ \Omega$, $C_L = 100\text{ pF}$ | 25°C | | 1.3 | | |
| Settling time | 0.1% | 25°C | | 5 | | μs |
| | 0.01% | 25°C | | 10 | | |
| BOM Maximum output-swing bandwidth | $A_{VD} = 1$, $R_L = 10\text{ k}\Omega$ | 25°C | | 140 | | kHz |
| ϕ_m Phase margin at unity gain (see Figure 3) | $R_L = 10\text{ k}\Omega$, $C_L = 100\text{ pF}$ | 25°C | | 58° | | |
| | $R_L = 100\ \Omega$, $C_L = 100\text{ pF}$ | 25°C | | 75° | | |

† Full range is -40°C to 85°C .



TLE206x, TLE206xA, TLE206xB
EXCALIBUR JFET-INPUT HIGH-OUTPUT-DRIVE
μPOWER OPERATIONAL AMPLIFIERS

SLOS193B – FEBRUARY 1997 – REVISED MAY 2004

TLE2062I electrical characteristics at specified free-air temperature, $V_{CC\pm} = \pm 15$ V (unless otherwise noted)

| PARAMETER | | TEST CONDITIONS | T_A^\dagger | TLE2062I TLE2062AI TLE2062BI | | | UNIT |
|----------------|---------------------------------------------------------------------|--------------------------------------------------------|--------------------|------------------------------------|-------|------------------|------|
| | | | | MIN | TYP | MAX | |
| V_{IO} | Input offset voltage | $V_{IC} = 0, R_S = 50 \Omega$ | 25°C | 0.9 | 4 | mV | |
| | | | Full range | 5.3 | | | |
| | | | 25°C | 0.8 | 2 | | |
| | | | Full range | 3.3 | | | |
| | | | 25°C | 0.5 | 1 | | |
| | | | Full range | 2.3 | | | |
| α_{VIO} | Temperature coefficient of input offset voltage | $V_{IC} = 0, R_S = 50 \Omega$ | Full range | 6 | | $\mu V/^\circ C$ | |
| | Input offset voltage long-term drift (see Note 4) | | 25°C | 0.04 | | $\mu V/mo$ | |
| I_{IO} | Input offset current | | 25°C | 2 | | pA | |
| | | | Full range | 3 | | nA | |
| I_{IB} | Input bias current | | 25°C | 4 | | pA | |
| | | | Full range | 5 | | nA | |
| V_{ICR} | Common-mode input voltage range | 25°C | -11 to 13 | -12 to 16 | V | | |
| | | Full range | -11 to 13 | | V | | |
| V_{OM+} | Maximum positive peak output voltage swing | $R_L = 10 k\Omega$ | 25°C | 13.2 | 13.7 | V | |
| | | | Full range | 13 | | | |
| | | | $R_L = 600 \Omega$ | 25°C | 12.5 | | 13.2 |
| | | | | Full range | 12 | | |
| V_{OM-} | Maximum negative peak output voltage swing | $R_L = 10 k\Omega$ | 25°C | -13.2 | -13.7 | V | |
| | | | Full range | -13 | | | |
| | | | $R_L = 600 \Omega$ | 25°C | -12.5 | | -13 |
| | | | | Full range | -12 | | |
| A_{VD} | Large-signal differential voltage amplification | $V_O = \pm 10$ V, $R_L = 10 k\Omega$ | 25°C | 30 | 230 | V/mV | |
| | | | Full range | 20 | | | |
| | | $V_O = 0$ to 8 V, $R_L = 600 \Omega$ | 25°C | 25 | 100 | | |
| | | | Full range | 10 | | | |
| | | $V_O = 0$ to -8 V, $R_L = 600 \Omega$ | 25°C | 3 | 25 | | |
| | | | Full range | 1 | | | |
| r_i | Input resistance | | 25°C | 10^{12} | | Ω | |
| c_i | Input capacitance | | 25°C | 4 | | pF | |
| z_o | Open-loop output impedance | $I_O = 0$ | 25°C | 560 | | Ω | |
| CMRR | Common-mode rejection ratio | $V_{IC} = V_{ICRmin}, R_S = 50 \Omega$ | 25°C | 72 | 90 | dB | |
| | | | Full range | 65 | | | |
| k_{SVR} | Supply-voltage rejection ratio ($\Delta V_{CC\pm}/\Delta V_{IO}$) | $V_{CC\pm} = \pm 5$ V to ± 15 V, $R_S = 50 \Omega$ | 25°C | 75 | 93 | dB | |
| | | | Full range | 65 | | | |

† Full range is -40°C to 85°C.

NOTE 4: Typical values are based on the input offset voltage shift observed through 168 hours of operating life test at $T_A = 150^\circ C$ extrapolated to $T_A = 25^\circ C$ using the Arrhenius equation and assuming an activation energy of 0.96 eV.



TLE206x, TLE206xA, TLE206xB
EXCALIBUR JFET-INPUT HIGH-OUTPUT-DRIVE
μPOWER OPERATIONAL AMPLIFIERS

SLOS193B – FEBRUARY 1997 – REVISED MAY 2004

TLE2062I electrical characteristics at specified free-air temperature, $V_{CC\pm} = \pm 15$ V (unless otherwise noted) (continued)

| PARAMETER | TEST CONDITIONS | T_A † | TLE2062I TLE2062AI TLE2062BI | | | UNIT |
|------------------------------------------------------------------------|---------------------|------------|------------------------------------|-----|-----|------|
| | | | MIN | TYP | MAX | |
| I_{CC} Supply current | $V_O = 0$, No load | 25°C | | 625 | 690 | μA |
| | | Full range | | | 720 | |
| ΔI_{CC} Supply-current change over operating temperature range | | Full range | | 74 | | μA |

† Full range is –40°C to 85°C.

TLE2062I operating characteristics at specified free-air temperature, $V_{CC\pm} = \pm 15$ V

| PARAMETER | TEST CONDITIONS | T_A † | TLE2062I TLE2062AI TLE2062BI | | | UNIT |
|---------------------------------------------------------|------------------------------------------------------------------|------------|------------------------------------|--------|-----|--------|
| | | | MIN | TYP | MAX | |
| SR Slew rate at unity gain (see Figure 1) | $R_L = 10$ kΩ, $C_L = 100$ pF | 25°C | 2.6 | 3.4 | | V/μs |
| | | Full range | 2.1 | | | |
| V_n Equivalent input noise voltage (see Figure 2) | $f = 10$ Hz, $R_S = 20$ Ω | 25°C | | 70 | 100 | nV/√Hz |
| | $f = 1$ kHz, $R_S = 20$ Ω | 25°C | | 40 | 60 | |
| $V_{N(PP)}$ Peak-to-peak equivalent input noise voltage | $f = 0.1$ Hz to 10 Hz | 25°C | | 1.1 | | μV |
| I_n Equivalent input noise current | $f = 1$ kHz | 25°C | | 1.1 | | fA/√Hz |
| THD Total harmonic distortion | $V_{O(PP)} = 2$ V, $R_L = 10$ kΩ, $A_{VD} = 2$, $f = 10$ kHz | 25°C | | 0.025% | | |
| B_1 Unity-gain bandwidth (see Figure 3) | $R_L = 10$ kΩ, $C_L = 100$ pF | 25°C | | 2 | | MHz |
| | $R_L = 600$ Ω, $C_L = 100$ pF | 25°C | | 1.5 | | |
| Settling time | 0.1% | 25°C | | 5 | | μs |
| | 0.01% | 25°C | | 10 | | |
| BOM Maximum output-swing bandwidth | $A_{VD} = 1$, $R_L = 10$ kΩ | 25°C | | 40 | | kHz |
| ϕ_m Phase margin at unity gain (see Figure 3) | $R_L = 10$ kΩ, $C_L = 100$ pF | 25°C | | 60° | | |
| | $R_L = 600$ Ω, $C_L = 100$ pF | 25°C | | 70° | | |

† Full range is –40°C to 85°C.

TLE206x, TLE206xA, TLE206xB
EXCALIBUR JFET-INPUT HIGH-OUTPUT-DRIVE
μPOWER OPERATIONAL AMPLIFIERS

SLOS193B – FEBRUARY 1997 – REVISED MAY 2004

TLE2062M electrical characteristics at specified free-air temperature, $V_{CC\pm} = \pm 5\text{ V}$

| PARAMETER | | TEST CONDITIONS | T_A † | TLE2062M TLE2062AM TLE2062BM | | | UNIT |
|----------------------------------------------------------|----------------------------------------------------------------|-------------------------------------------------------------------------------------|------------|------------------------------------|------------------------------|------|------|
| | | | | MIN | TYP | MAX | |
| V_{IO} | Input offset voltage | $V_{IC} = 0, \quad R_S = 50\ \Omega$ | 25°C | 1 | 5 | mV | |
| | | | Full range | 7 | | | |
| | | | 25°C | 0.9 | 4 | | |
| | Full range | | 6 | | | | |
| | 25°C | | 0.7 | 3 | | | |
| | Full range | | 5 | | | | |
| | α_{VIO} Temperature coefficient of input offset voltage | | Full range | 6 | $\mu\text{V}/^\circ\text{C}$ | | |
| | Input offset voltage long-term drift (see Note 4) | | 25°C | 0.04 | $\mu\text{V}/\text{mo}$ | | |
| | I_{IO} Input offset current | | 25°C | 1 | pA | | |
| I_{IB} Input bias current | Full range | 15 | | nA | | | |
| | 25°C | 3 | pA | | | | |
| V_{ICR} Common-mode input voltage range | | 25°C | -1.6 to 4 | -2 to 6 | V | | |
| | | Full range | -1.6 to 4 | | V | | |
| V_{OM+} Maximum positive peak output voltage swing | | $R_L = 10\ \text{k}\Omega$ | 25°C | 3.5 | 3.7 | V | |
| | | | Full range | 3 | | | |
| | | FK and JG packages $R_L = 600\ \Omega$ | 25°C | 2.5 | 3.6 | | |
| | | | Full range | 2 | | | |
| | | D and P packages $R_L = 100\ \Omega$ | 25°C | 2.5 | 3.1 | | |
| | | | Full range | 2 | | | |
| V_{OM-} Maximum negative peak output voltage swing | | $R_L = 10\ \text{k}\Omega$ | 25°C | -3.5 | -3.9 | V | |
| | | | Full range | -3 | | | |
| | | FK and JG packages $R_L = 600\ \Omega$ | 25°C | -2.5 | -3.5 | | |
| | | | Full range | -2 | | | |
| | | D and P packages $R_L = 100\ \Omega$ | 25°C | -2.5 | -2.7 | | |
| | | | Full range | -2 | | | |
| A_{VD} Large-signal differential voltage amplification | | $V_O = \pm 2.8\ \text{V}, \quad R_L = 10\ \text{k}\Omega$ | 25°C | 15 | 80 | V/mV | |
| | | | Full range | 2 | | | |
| | | FK and JG packages $V_O = 0\ \text{to}\ 2.5\ \text{V}, \quad R_L = 600\ \Omega$ | 25°C | 1 | 65 | | |
| | | | Full range | 0.5 | | | |
| | | FK and JG packages $V_O = 0\ \text{to}\ -2.5\ \text{V}, \quad R_L = 600\ \Omega$ | 25°C | 1 | 16 | | |
| | | | Full range | 0.5 | | | |
| | | D and P packages $V_O = 0\ \text{to}\ 2\ \text{V}, \quad R_L = 100\ \Omega$ | 25°C | 0.75 | 45 | | |
| | | | Full range | 0.5 | | | |
| | | D and P packages $V_O = 0\ \text{to}\ -2\ \text{V}, \quad R_L = 100\ \Omega$ | 25°C | 0.5 | 3 | | |
| | | | Full range | 0.25 | | | |

† Full range is -55°C to 125°C .

NOTE 4: Typical values are based on the input offset voltage shift observed through 168 hours of operating life test at $T_A = 150^\circ\text{C}$ extrapolated to $T_A = 25^\circ\text{C}$ using the Arrhenius equation and assuming an activation energy of 0.96 eV.



TLE206x, TLE206xA, TLE206xB
EXCALIBUR JFET-INPUT HIGH-OUTPUT-DRIVE
μPOWER OPERATIONAL AMPLIFIERS

SLOS193B – FEBRUARY 1997 – REVISED MAY 2004

TLE2062M electrical characteristics at specified free-air temperature, $V_{CC\pm} = \pm 5\text{ V}$ (unless otherwise noted)

| PARAMETER | TEST CONDITIONS | T_A † | TLE2062M TLE2062AM TLE2062BM | | | UNIT |
|-----------------------------------------------------------------------------------------|--------------------------------------------------------------------------|------------|------------------------------------|-----|-----|------|
| | | | MIN | TYP | MAX | |
| r_i Input resistance | | 25°C | 10 ¹² | | | Ω |
| c_i Input capacitance | | 25°C | 4 | | | pF |
| z_o Open-loop output impedance | $I_O = 0$ | 25°C | 560 | | | Ω |
| CMRR Common-mode rejection ratio | $V_{IC} = V_{ICRmin}$ $R_S = 50\ \Omega$ | 25°C | 65 | 82 | | dB |
| | | Full range | 60 | | | |
| k_{SVR} Supply-voltage rejection ratio ($\Delta V_{CC\pm}/\Delta V_{IO}$) | $V_{CC\pm} = \pm 5\text{ V to } \pm 15\text{ V}$, $R_S = 50\ \Omega$ | 25°C | 75 | 93 | | dB |
| | | Full range | 65 | | | |
| I_{CC} Supply current (two amplifiers) | $V_O = 0$, No load | 25°C | 560 | 620 | | μA |
| | | Full range | 650 | | | |
| ΔI_{CC} Supply-current change over operating temperature range (two amplifiers) | | Full range | 72 | | | μA |

† Full range is -55°C to 125°C.

TLE2062M operating characteristics at specified free-air temperature, $T_A = 25^\circ\text{C}$, $V_{CC\pm} = \pm 5\text{ V}$

| PARAMETER | TEST CONDITIONS | TLE2062M TLE2062AM TLE2062BM | | | UNIT |
|-------------------------------------------------------|----------------------------------------------------------------------------------------------|------------------------------------|-----|-----|--------|
| | | MIN | TYP | MAX | |
| SR Slew rate at unity gain (see Figure 1) | $R_L = 10\text{ k}\Omega$, $C_L = 100\text{ pF}$ | 3.4 | | | V/μs |
| V_n Equivalent input noise voltage (see Figure 2) | $f = 10\text{ Hz}$, $R_S = 20\ \Omega$ | 59 | | | nV/√Hz |
| | $f = 1\text{ kHz}$, $R_S = 20\ \Omega$ | 43 | | | |
| $V_N(PP)$ Peak-to-peak equivalent input noise voltage | $f = 0.1\text{ Hz to } 10\text{ Hz}$ | 1.1 | | | μV |
| I_n Equivalent input noise current | $f = 1\text{ kHz}$ | 1 | | | fA/√Hz |
| THD Total harmonic distortion | $V_{O(PP)} = 2\text{ V}$, $R_L = 10\text{ k}\Omega$, $A_{VD} = 2$, $f = 10\text{ kHz}$ | 0.025% | | | |
| B_1 Unity-gain bandwidth (see Figure 3) | $R_L = 10\text{ k}\Omega$, $C_L = 100\text{ pF}$ | 1.8 | | | MHz |
| | $R_L = 600\ \Omega$, $C_L = 100\text{ pF}$ | 1.3 | | | |
| Settling time | 0.1% | 5 | | | μs |
| | 0.01% | 10 | | | |
| B_{OM} Maximum output-swing bandwidth | $A_{VD} = 1$, $R_L = 10\text{ k}\Omega$ | 140 | | | kHz |
| ϕ_m Phase margin at unity gain (see Figure 3) | $R_L = 10\text{ k}\Omega$, $C_L = 100\text{ pF}$ | 58° | | | |
| | $R_L = 600\ \Omega$, $C_L = 100\text{ pF}$ | 75° | | | |



TLE206x, TLE206xA, TLE206xB
EXCALIBUR JFET-INPUT HIGH-OUTPUT-DRIVE
μPOWER OPERATIONAL AMPLIFIERS

SLOS193B – FEBRUARY 1997 – REVISED MAY 2004

TLE2062M electrical characteristics at specified free-air temperature, $V_{CC\pm} = \pm 15\text{ V}$ (unless otherwise noted)

| PARAMETER | | TEST CONDITIONS | T_A^\dagger | TLE2062M TLE2062AM TLE2062BM | | | UNIT |
|----------------|-----------------------------------------------------------------------|----------------------------------------------------------------------------|---------------|------------------------------------|-------|------------------------------|------|
| | | | | MIN | TYP | MAX | |
| V_{IO} | Input offset voltage | $V_{IC} = 0, \quad R_S = 50\ \Omega$ | 25°C | 0.9 | | 4 | mV |
| | | | Full range | | | 6 | |
| | | | 25°C | 0.8 | | 2 | |
| | | | Full range | | | 4 | |
| | | | 25°C | 0.5 | | 1 | |
| | | | Full range | | | 3 | |
| α_{VIO} | Temperature coefficient of input offset voltage | $V_{IC} = 0, \quad R_S = 50\ \Omega$ | Full range | 6 | | $\mu\text{V}/^\circ\text{C}$ | |
| | Input offset voltage long-term drift (see Note 4) | | 25°C | 0.04 | | $\mu\text{V}/\text{mo}$ | |
| I_{IO} | Input offset current | | 25°C | 2 | | pA | |
| | | | Full range | | | 20 | |
| I_{IB} | Input bias current | | 25°C | 4 | | pA | |
| | | | Full range | | | 40 | |
| V_{ICR} | Common-mode input voltage range | 25°C | -11 to 13 | -12 to 16 | | V | |
| | | Full range | -11 to 13 | | | V | |
| V_{OM+} | Maximum positive peak output voltage swing | $R_L = 10\ \text{k}\Omega$ | 25°C | 13 | 13.7 | V | |
| | | | Full range | 12.5 | | | |
| | | $R_L = 600\ \Omega$ | 25°C | 12.5 | 13.2 | | |
| | | | Full range | 11 | | | |
| V_{OM-} | Maximum negative peak output voltage swing | $R_L = 10\ \text{k}\Omega$ | 25°C | -13 | -13.7 | V | |
| | | | Full range | -12.5 | | | |
| | | $R_L = 600\ \Omega$ | 25°C | -12.5 | -13 | | |
| | | | Full range | -11 | | | |
| A_{VD} | Large-signal differential voltage amplification | $V_O = \pm 10\ \text{V}, \quad R_L = 10\ \text{k}\Omega$ | 25°C | 30 | 230 | V/mV | |
| | | | Full range | 20 | | | |
| | | $V_O = 0\ \text{to}\ 8\ \text{V}, \quad R_L = 600\ \Omega$ | 25°C | 25 | 100 | | |
| | | | Full range | 7 | | | |
| | | $V_O = 0\ \text{to}\ -8\ \text{V}, \quad R_L = 600\ \Omega$ | 25°C | 3 | 25 | | |
| | | | Full range | 1 | | | |
| r_i | Input resistance | | 25°C | 10^{12} | | Ω | |
| c_i | Input capacitance | | 25°C | 4 | | pF | |
| z_o | Open-loop output impedance | $I_O = 0$ | 25°C | 560 | | Ω | |
| CMRR | Common-mode rejection ratio | $V_{IC} = V_{ICR\text{min}}, \quad R_S = 50\ \Omega$ | 25°C | 72 | 90 | dB | |
| | | | Full range | 65 | | | |
| k_{SVR} | Supply-voltage rejection ratio ($\Delta V_{CC\pm} / \Delta V_{IO}$) | $V_{CC\pm} = \pm 5\ \text{V to } \pm 15\ \text{V}, \quad R_S = 50\ \Omega$ | 25°C | 75 | 93 | dB | |
| | | | Full range | 65 | | | |

† Full range is -55°C to 125°C .

NOTE 4: Typical values are based on the input offset voltage shift observed through 168 hours of operating life test at $T_A = 150^\circ\text{C}$ extrapolated to $T_A = 25^\circ\text{C}$ using the Arrhenius equation and assuming an activation energy of 0.96 eV.



TLE206x, TLE206xA, TLE206xB
EXCALIBUR JFET-INPUT HIGH-OUTPUT-DRIVE
μPOWER OPERATIONAL AMPLIFIERS

SLOS193B – FEBRUARY 1997 – REVISED MAY 2004

TLE2062M electrical characteristics at specified free-air temperature, $V_{CC\pm} = \pm 15$ V (unless otherwise noted)

| PARAMETER | TEST CONDITIONS | T_A † | TLE2062M TLE2062AM TLE2062BM | | | UNIT |
|------------------------------------------------------------------------|---------------------|------------|------------------------------------|-----|-----|------|
| | | | MIN | TYP | MAX | |
| I_{CC} Supply current | $V_O = 0$, No load | 25°C | | 625 | 690 | μA |
| | | Full range | | | 730 | |
| ΔI_{CC} Supply-current change over operating temperature range | | Full range | | 97 | | μA |

† Full range is –55°C to 125°C.

TLE2062M operating characteristics at specified free-air temperature, $V_{CC\pm} = \pm 15$ V

| PARAMETER | TEST CONDITIONS | T_A † | TLE2062M TLE2062AM TLE2062BM | | | UNIT |
|---------------------------------------------------------|---------------------------------------------------------------|------------|------------------------------------|--------|-----|--------|
| | | | MIN | TYP | MAX | |
| SR Slew rate at unity gain (see Figure 1) | $R_L = 10$ kΩ, $C_L = 100$ pF | 25°C | 2 | 3.4 | | V/μs |
| | | Full range | 1.8 | | | |
| V_n Equivalent input noise voltage (see Figure 2) | $f = 10$ Hz, $R_S = 20$ Ω | 25°C | | 70 | | nV/√Hz |
| | $f = 1$ kHz, $R_S = 20$ Ω | 25°C | | 40 | | |
| $V_{N(PP)}$ Peak-to-peak equivalent input noise voltage | $f = 0.1$ Hz to 10 Hz | 25°C | | 1.1 | | μV |
| I_n Equivalent input noise current | $f = 1$ kHz | 25°C | | 1.1 | | fA/√Hz |
| THD Total harmonic distortion | $V_{O(PP)} = 2$ V, $R_L = 10$ kΩ, $A_{VD} = 2$, $f = 10$ kHz | 25°C | | 0.025% | | |
| B_1 Unity-gain bandwidth (see Figure 3) | $R_L = 10$ kΩ, $C_L = 100$ pF | 25°C | | 2 | | MHz |
| | $R_L = 600$ Ω, $C_L = 100$ pF | 25°C | | 1.5 | | |
| Settling time | 0.1% | 25°C | | 5 | | μs |
| | 0.01% | 25°C | | 10 | | |
| B_{OM} Maximum output-swing bandwidth | $A_{VD} = 1$, $R_L = 10$ kΩ | 25°C | | 40 | | kHz |
| ϕ_m Phase margin at unity gain (see Figure 3) | $R_L = 10$ kΩ, $C_L = 100$ pF | 25°C | | 60° | | |
| | $R_L = 600$ Ω, $C_L = 100$ pF | 25°C | | 70° | | |

† Full range is –55°C to 125°C.



TLE206x, TLE206xA, TLE206xB
EXCALIBUR JFET-INPUT HIGH-OUTPUT-DRIVE
μPOWER OPERATIONAL AMPLIFIERS

SLOS193B – FEBRUARY 1997 – REVISED MAY 2004

TLE2062Y electrical characteristics at $V_{CC\pm} = \pm 15\text{ V}$, $T_A = 25^\circ\text{C}$ (unless otherwise noted)

| PARAMETER | TEST CONDITIONS | TLE2062Y | | | UNIT |
|----------------------------------------------------------------------------|-----------------------------------------------------------------------------|-----------------|-----------------|-----|-------------------------|
| | | MIN | TYP | MAX | |
| V_{IO} Input offset voltage | $V_{IC} = 0$, $R_S = 50\ \Omega$ | | 0.9 | 4 | mV |
| αV_{IO} Input offset voltage long-term drift (see Note 4) | | | 0.04 | | $\mu\text{V}/\text{mo}$ |
| I_{IO} Input offset current | | | 2 | | pA |
| I_{IB} Input bias current | | | 4 | | pA |
| V_{ICR} Common-mode input voltage range | | -11 to 13 | -12 to 16 | | V |
| V_{OM+} Maximum positive peak output voltage swing | $R_L = 10\ \text{k}\Omega$ | 13.2 | 13.7 | | V |
| | $R_L = 600\ \Omega$ | 12.5 | 13.2 | | |
| V_{OM-} Maximum negative peak output voltage swing | $R_L = 10\ \text{k}\Omega$ | -13.2 | -13.7 | | V |
| | $R_L = 600\ \Omega$ | -12.5 | -13 | | |
| A_{VD} Large-signal differential voltage amplification | $V_O = \pm 10\ \text{V}$, $R_L = 10\ \text{k}\Omega$ | 30 | 230 | | V/mV |
| | $V_O = 0$ to $8\ \text{V}$, $R_L = 600\ \Omega$ | 25 | 100 | | |
| | $V_O = 0$ to $-8\ \text{V}$, $R_L = 600\ \Omega$ | 3 | 25 | | |
| r_i Input resistance | | | 10^{12} | | Ω |
| c_i Input capacitance | | | 4 | | pF |
| z_o Open-loop output impedance | $I_O = 0$ | | 560 | | Ω |
| CMRR Common-mode rejection ratio | $V_{IC} = V_{ICR\text{min}}$, $R_S = 50\ \Omega$ | 72 | 90 | | dB |
| k_{SVR} Supply-voltage rejection ratio ($\Delta V_{CC}/\Delta V_{IO}$) | $V_{CC\pm} = \pm 5\ \text{V}$ to $\pm 15\ \text{V}$, $R_S = 50\ \Omega$ | 75 | 93 | | dB |
| I_{CC} Supply current | $V_O = 0$, No load | | 625 | 690 | μA |

NOTE 4: Typical values are based on the input offset voltage shift observed through 168 hours of operating life test at $T_A = 150^\circ\text{C}$ extrapolated to $T_A = 25^\circ\text{C}$ using the Arrhenius equation and assuming an activation energy of 0.96 eV.

TLE2062Y operating characteristics at $V_{CC\pm} = \pm 15\ \text{V}$, $T_A = 25^\circ\text{C}$

| PARAMETER | TEST CONDITIONS | TLE2062Y | | | UNIT |
|---------------------------------------------------------|-------------------------------------------------------------------------------------------------|----------|--------|-----|------------------------------|
| | | MIN | TYP | MAX | |
| SR Slew rate at unity gain (see Figure 1) | $R_L = 10\ \text{k}\Omega$, $C_L = 100\ \text{pF}$ | 2.6 | 3.4 | 4 | $\text{V}/\mu\text{s}$ |
| V_n Equivalent input noise voltage (see Figure 2) | $f = 10\ \text{Hz}$, $R_S = 20\ \Omega$ | | 70 | | $\text{nV}/\sqrt{\text{Hz}}$ |
| | $f = 1\ \text{kHz}$, $R_S = 20\ \Omega$ | | 40 | | |
| $V_{N(PP)}$ Peak-to-peak equivalent input noise voltage | $f = 0.1\ \text{Hz}$ to $10\ \text{Hz}$ | | 1.1 | | μV |
| I_n Equivalent input noise current | $f = 1\ \text{Hz}$ | | 1.1 | | $\text{fA}/\sqrt{\text{Hz}}$ |
| THD Total harmonic distortion | $V_{O(PP)} = 2\ \text{V}$, $R_L = 10\ \text{k}\Omega$, $A_{VD} = 2$, $f = 10\ \text{kHz}$ | | 0.025% | | |
| B_1 Unity-gain bandwidth (see Figure 3) | $R_L = 10\ \text{k}\Omega$, $C_L = 100\ \text{pF}$ | | 2 | | MHz |
| | $R_L = 600\ \Omega$, $C_L = 100\ \text{pF}$ | | 1.5 | | |
| Settling time | 0.1% | | 5 | | μs |
| | 0.01% | | 10 | | |
| B_{OM} Maximum output-swing bandwidth | $A_{VD} = 1$, $R_L = 10\ \text{k}\Omega$ | | 40 | | kHz |
| ϕ_m Phase margin at unity gain (see Figure 3) | $R_L = 10\ \text{k}\Omega$, $C_L = 100\ \text{pF}$ | | 60° | | |
| | $R_L = 600\ \Omega$, $C_L = 100\ \text{pF}$ | | 70° | | |



TLE206x, TLE206xA, TLE206xB
EXCALIBUR JFET-INPUT HIGH-OUTPUT-DRIVE
μPOWER OPERATIONAL AMPLIFIERS

SLOS193B – FEBRUARY 1997 – REVISED MAY 2004

TLE2064C electrical characteristics at specified free-air temperature, $V_{CC\pm} = \pm 5\text{ V}$ (unless otherwise noted)

| PARAMETER | | TEST CONDITIONS | T_A † | TLE2064C TLE2064AC TLE2064BC | | | UNIT |
|---------------------------------------------------|-----------------------------------------------------------------------|-----------------------------------------------------------------------------------|------------|------------------------------------|---------|------------------------------|------|
| | | | | MIN | TYP | MAX | |
| V_{IO} | Input offset voltage | $V_{IC} = 0,$ $R_S = 50\ \Omega$ | 25°C | 1.2 | 7 | mV | |
| | | | Full range | 7.9 | | | |
| | | | 25°C | 1.2 | 6 | | |
| | | | Full range | 6.9 | | | |
| α_{VIO} | Temperature coefficient of input offset voltage | $V_{IC} = 0,$ $R_S = 50\ \Omega$ | 25°C | 0.8 | 3.5 | $\mu\text{V}/^\circ\text{C}$ | |
| | | | Full range | 4.4 | | | |
| Input offset voltage long-term drift (see Note 4) | | $V_{IC} = 0,$ $R_S = 50\ \Omega$ | 25°C | 6 | | $\mu\text{V}/\text{mo}$ | |
| | | | Full range | 0.04 | | | |
| I_{IO} | Input offset current | $V_{IC} = 0,$ $R_S = 50\ \Omega$ | 25°C | 1 | | pA | |
| | | | Full range | 0.8 | | nA | |
| I_{IB} | Input bias current | $V_{IC} = 0,$ $R_S = 50\ \Omega$ | 25°C | 3 | | pA | |
| | | | Full range | 2 | | nA | |
| V_{ICR} | Common-mode input voltage range | | 25°C | -1.6 to 4 | -2 to 6 | V | |
| | | | Full range | -1.6 to 4 | | V | |
| V_{OM+} | Maximum positive peak output voltage swing | $R_L = 10\ \text{k}\Omega$ | 25°C | 3.5 | 3.7 | V | |
| | | | Full range | 3.3 | | | |
| | | | 25°C | 2.5 | 3.1 | | |
| | | | Full range | 2 | | | |
| V_{OM-} | Maximum negative peak output voltage swing | $R_L = 10\ \text{k}\Omega$ | 25°C | -3.7 | -3.9 | V | |
| | | | Full range | -3.3 | | | |
| | | | 25°C | -2.5 | -2.7 | | |
| | | | Full range | -2 | | | |
| A_{VD} | Large-signal differential voltage amplification | $V_O = \pm 2.8\ \text{V},$ $R_L = 10\ \text{k}\Omega$ | 25°C | 15 | 80 | V/mV | |
| | | | Full range | 2 | | | |
| | | $V_O = 0\ \text{to}\ 2\ \text{V},$ $R_L = 100\ \Omega$ | 25°C | 0.75 | 45 | | |
| | | | Full range | 0.5 | | | |
| | | $V_O = 0\ \text{to}\ -2\ \text{V},$ $R_L = 100\ \Omega$ | 25°C | 0.5 | 3 | | |
| | | | Full range | 0.15 | | | |
| r_i | Input resistance | | 25°C | 10^{12} | | Ω | |
| c_i | Input capacitance | | 25°C | 4 | | pF | |
| z_o | Open-loop output impedance | $I_O = 0$ | 25°C | 560 | | Ω | |
| CMRR | Common-mode rejection ratio | $V_{IC} = V_{ICRmin},$ $R_S = 50\ \Omega$ | 25°C | 65 | 82 | dB | |
| | | | Full range | 65 | | | |
| k_{SVR} | Supply-voltage rejection ratio ($\Delta V_{CC\pm} / \Delta V_{IO}$) | $V_{CC\pm} = \pm 5\ \text{V}\ \text{to}\ \pm 15\ \text{V},$ $R_S = 50\ \Omega$ | 25°C | 75 | 93 | dB | |
| | | | Full range | 75 | | | |

† Full range is 0°C to 70°C.

NOTE 4: Typical values are based on the input offset voltage shift observed through 168 hours of operating life test at $T_A = 150^\circ\text{C}$ extrapolated to $T_A = 25^\circ\text{C}$ using the Arrhenius equation and assuming an activation energy of 0.96 eV.



TLE206x, TLE206xA, TLE206xB
EXCALIBUR JFET-INPUT HIGH-OUTPUT-DRIVE
μPOWER OPERATIONAL AMPLIFIERS

SLOS193B – FEBRUARY 1997 – REVISED MAY 2004

TLE2064C electrical characteristics at specified free-air temperature, $V_{CC\pm} = \pm 5\text{ V}$ (unless otherwise noted) (continued)

| PARAMETER | TEST CONDITIONS | T_A † | TLE2064C TLE2064AC TLE2064BC | | | UNIT |
|------------------------------------------------------------------------------------------|--------------------------------------|------------|------------------------------------|-----|-----|------|
| | | | MIN | TYP | MAX | |
| I_{CC} Supply current (four amplifiers) | $V_O = 0$, No load | 25°C | 1.12 | 1.3 | | mA |
| | | Full range | | 1.3 | | |
| ΔI_{CC} Supply-current change over operating temperature range (four amplifiers) | | Full range | 52 | | | μA |
| V_{O1}/V_{O2} Crosstalk attenuation | $A_{VD} = 1000$, $f = 1\text{ kHz}$ | 25°C | 120 | | | dB |

† Full range is 0°C to 70°C.

TLE2064C operating characteristics at specified free-air temperature, $V_{CC\pm} = \pm 5\text{ V}$

| PARAMETER | TEST CONDITIONS | T_A † | TLE2064C TLE2064AC TLE2064BC | | | UNIT |
|---------------------------------------------------------|----------------------------------------------------------------------------------------------|------------|------------------------------------|-----|-----|--------|
| | | | MIN | TYP | MAX | |
| SR Slew rate at unity gain (see Figure 1) | $R_L = 10\text{ k}\Omega$, $C_L = 100\text{ pF}$ | 25°C | 2.2 | 3.4 | | V/μs |
| | | Full range | 2.1 | | | |
| V_n Equivalent input noise voltage (see Figure 2) | $f = 10\text{ Hz}$, $R_S = 20\ \Omega$ | 25°C | | 59 | 100 | nV/√Hz |
| | $f = 1\text{ kHz}$, $R_S = 20\ \Omega$ | | | 43 | 60 | |
| $V_{N(PP)}$ Peak-to-peak equivalent input noise voltage | $f = 0.1\text{ Hz to }10\text{ Hz}$ | 25°C | 1.1 | | | μV |
| I_n Equivalent input noise current | $f = 1\text{ kHz}$ | 25°C | 1 | | | fA/√Hz |
| THD Total harmonic distortion | $A_{VD} = 2$, $f = 10\text{ kHz}$, $V_{O(PP)} = 2\text{ V}$, $R_L = 10\text{ k}\Omega$ | 25°C | 0.025% | | | |
| B_1 Unity-gain bandwidth (see Figure 3) | $R_L = 10\text{ k}\Omega$, $C_L = 100\text{ pF}$ | 25°C | 1.8 | | | MHz |
| | $R_L = 100\ \Omega$, $C_L = 100\text{ pF}$ | | 1.3 | | | |
| t_s Settling time | $\epsilon = 0.1\%$ | 25°C | 5 | | | μs |
| | $\epsilon = 0.01\%$ | | 10 | | | |
| B_{OM} Maximum output-swing bandwidth | $A_{VD} = 1$, $R_L = 10\text{ k}\Omega$ | 25°C | 140 | | | kHz |
| ϕ_m Phase margin at unity gain (see Figure 3) | $R_L = 10\text{ k}\Omega$, $C_L = 100\text{ pF}$ | 25°C | 58° | | | |
| | $R_L = 100\ \Omega$, $C_L = 100\text{ pF}$ | | 75° | | | |

† Full range is 0°C to 70°C.

TLE206x, TLE206xA, TLE206xB
EXCALIBUR JFET-INPUT HIGH-OUTPUT-DRIVE
μPOWER OPERATIONAL AMPLIFIERS

SLOS193B – FEBRUARY 1997 – REVISED MAY 2004

TLE2064C electrical characteristics at specified free-air temperature, $V_{CC\pm} = \pm 15\text{ V}$ (unless otherwise noted)

| PARAMETER | | TEST CONDITIONS | T _A † | TLE2064C TLE2064AC TLE2064BC | | | UNIT |
|------------------|-----------------------------------------------------------------------|---------------------------------------------------------------|------------------|------------------------------------|-----------|-------|------|
| | | | | MIN | TYP | MAX | |
| V _{IO} | Input offset voltage | V _{IC} = 0, R _S = 50 Ω | 25°C | 0.9 | 6 | mV | |
| | | | Full range | 6.9 | | | |
| | | | 25°C | 0.9 | 4 | | |
| | | | Full range | 4.9 | | | |
| | | | 25°C | 0.7 | 2 | | |
| | | | Full range | 4 | | | |
| α _{VIO} | Temperature coefficient of input offset voltage | V _{IC} = 0, R _S = 50 Ω | 25°C | 6 | | μV/°C | |
| | Input offset voltage long-term drift (see Note 4) | | Full range | 0.04 | | μV/mo | |
| I _{IO} | Input offset current | | 25°C | 2 | | pA | |
| | | | Full range | 1 | | nA | |
| I _{IB} | Input bias current | | 25°C | 4 | | pA | |
| | | | Full range | 3 | | nA | |
| V _{ICR} | Common-mode input voltage range | | 25°C | -11 to 13 | -12 to 16 | V | |
| | | | Full range | -11 to 13 | | V | |
| V _{OM+} | Maximum positive peak output voltage swing | R _L = 10 kΩ | 25°C | 13.2 | 13.7 | V | |
| | | | Full range | 13 | | | |
| | | | 25°C | 12.5 | 13.2 | | |
| | | | Full range | 12 | | | |
| V _{OM-} | Maximum negative peak output voltage swing | R _L = 10 kΩ | 25°C | -13.2 | -13.7 | V | |
| | | | Full range | -13 | | | |
| | | | 25°C | -12.5 | -13 | | |
| | | | Full range | -12 | | | |
| A _{VD} | Large-signal differential voltage amplification | V _O = ±10 V, R _L = 10 kΩ | 25°C | 30 | 230 | V/mV | |
| | | | Full range | 20 | | | |
| | | V _O = 0 to 8 V, R _L = 600 Ω | 25°C | 25 | 100 | | |
| | | | Full range | 10 | | | |
| | | V _O = 0 to -8 V, R _L = 600 Ω | 25°C | 3 | 25 | | |
| | | | Full range | 1 | | | |
| r _i | Input resistance | | 25°C | 10 ¹² | | Ω | |
| c _i | Input capacitance | | 25°C | 4 | | pF | |
| z _o | Open-loop output impedance | I _O = 0 | 25°C | 560 | | Ω | |
| CMRR | Common-mode rejection ratio | V _{IC} = V _{ICRmin} , R _S = 50 Ω | 25°C | 72 | 90 | dB | |
| | | | Full range | 70 | | | |
| k _{SVR} | Supply-voltage rejection ratio (ΔV _{CC±} /ΔV _{IO}) | V _{CC±} = ±5 V to ±15 V, R _S = 50 Ω | 25°C | 75 | 93 | dB | |
| | | | Full range | 75 | | | |

† Full range is 0°C to 70°C.

NOTE 4: Typical values are based on the input offset voltage shift observed through 168 hours of operating life test at T_A = 150°C extrapolated to T_A = 25°C using the Arrhenius equation and assuming an activation energy of 0.96 eV.



TLE206x, TLE206xA, TLE206xB
EXCALIBUR JFET-INPUT HIGH-OUTPUT-DRIVE
μPOWER OPERATIONAL AMPLIFIERS

SLOS193B – FEBRUARY 1997 – REVISED MAY 2004

TLE2064C electrical characteristics at specified free-air temperature, $V_{CC\pm} = \pm 15$ V (unless otherwise noted) (continued)

| PARAMETER | TEST CONDITIONS | T_A † | TLE2064C TLE2064AC TLE2064BC | | | UNIT |
|------------------------------------------------------------------------------------------|----------------------------------|------------|------------------------------------|-----|-----|------|
| | | | MIN | TYP | MAX | |
| I_{CC} Supply current (four amplifiers) | $V_O = 0$, No load | 25°C | 1.25 | 1.4 | mA | |
| | | Full range | 1.5 | | | |
| ΔI_{CC} Supply-current change over operating temperature range (four amplifiers) | | Full range | 72 | | μA | |
| V_{O1}/V_{O2} Crosstalk attenuation | $A_{VD} = 1000$, $f = 1$ kHz | 25°C | 120 | | dB | |

† Full range is 0°C to 70°C.

TLE2064C operating characteristics at specified free-air temperature, $V_{CC\pm} = \pm 15$ V

| PARAMETER | TEST CONDITIONS | T_A † | TLE2064C TLE2064AC TLE2064BC | | | UNIT |
|---------------------------------------------------------|---------------------------------------------------------------------|------------|------------------------------------|-----|----------------|------|
| | | | MIN | TYP | MAX | |
| SR Slew rate at unity gain (see Figure 1) | $R_L = 10$ kΩ, $C_L = 100$ pF | 25°C | 2.6 | 3.4 | V/μs | |
| | | Full range | 2.5 | | | |
| V_n Equivalent input noise voltage (see Figure 2) | $f = 10$ Hz, $R_S = 20$ Ω | 25°C | 70 | 100 | nV/\sqrt{Hz} | |
| | $f = 1$ kHz, $R_S = 20$ Ω | | 40 | 60 | | |
| $V_{N(PP)}$ Peak-to-peak equivalent input noise voltage | $f = 0.1$ Hz to 10 Hz | 25°C | 1.1 | | μV | |
| I_n Equivalent input noise current | $f = 1$ kHz | 25°C | 1 | | fA/√Hz | |
| THD Total harmonic distortion | $A_{VD} = 2$, $V_{O(PP)} = 2$ V, $f = 10$ kHz, $R_L = 10$ kΩ | 25°C | 0.025% | | | |
| B_1 Unity-gain bandwidth (see Figure 3) | $R_L = 10$ kΩ, $C_L = 100$ pF | 25°C | 2 | | MHz | |
| | $R_L = 600$ Ω, $C_L = 100$ pF | | 1.5 | | | |
| t_s Settling time | $\epsilon = 0.1\%$ | 25°C | 5 | | μs | |
| | $\epsilon = 0.01\%$ | | 10 | | | |
| B_{OM} Maximum output-swing bandwidth | $A_{VD} = 1$, $R_L = 10$ kΩ | 25°C | 40 | | kHz | |
| ϕ_m Phase margin at unity gain (see Figure 3) | $R_L = 10$ kΩ, $C_L = 100$ pF | 25°C | 50° | | | |
| | $R_L = 600$ Ω, $C_L = 100$ pF | | 70° | | | |

† Full range is 0°C to 70°C.



TLE206x, TLE206xA, TLE206xB
EXCALIBUR JFET-INPUT HIGH-OUTPUT-DRIVE
μPOWER OPERATIONAL AMPLIFIERS

SLOS193B – FEBRUARY 1997 – REVISED MAY 2004

TLE2064I electrical characteristics at specified free-air temperature, $V_{CC\pm} = \pm 5\text{ V}$ (unless otherwise noted)

| PARAMETER | | TEST CONDITIONS | T_A † | TLE2064I TLE2064AI TLE2064BI | | | UNIT | |
|-----------|-----------------------------------------------------------------------|----------------------------------------------------------------------|----------------|---------------------------------------------------|---------------|------|------|------------------------------|
| | | | | MIN | TYP | MAX | | |
| V_{IO} | Input offset voltage | $V_{IC} = 0,$ $R_S = 50\ \Omega$ | 25°C | 1.2 | 7 | mV | | |
| | | | Full range | 8.3 | | | | |
| | | | 25°C | 1.2 | 6 | | | |
| | | | Full range | 7.3 | | | | |
| | | | 25°C | 0.8 | 3.5 | | | |
| | | | Full range | 4.8 | | | | |
| | | | α_{VIO} | Temperature coefficient of input offset voltage | 25°C | | 6 | $\mu\text{V}/^\circ\text{C}$ |
| | | | | Input offset voltage long-term drift (see Note 4) | Full range | | 0.04 | $\mu\text{V}/\text{mo}$ |
| I_{IO} | Input offset current | 25°C | 1 | pA | | | | |
| | | Full range | 2 | nA | | | | |
| I_{IB} | Input bias current | 25°C | 3 | pA | | | | |
| | | Full range | 4 | nA | | | | |
| V_{ICR} | Common-mode input voltage range | | 25°C | -1.6 to 4 | -2 to 6 | V | | |
| | | | Full range | -1.6 to 4 | | V | | |
| V_{OM+} | Maximum positive peak output voltage swing | $R_L = 10\ \text{k}\Omega$ | 25°C | 3.5 | 3.7 | V | | |
| | | | Full range | 3.1 | | | | |
| | | | 25°C | 2.5 | 3.1 | | | |
| | | | Full range | 2 | | | | |
| V_{OM-} | Maximum negative peak output voltage swing | $R_L = 10\ \text{k}\Omega$ | 25°C | -3.7 | -3.9 | V | | |
| | | | Full range | -3.1 | | | | |
| | | | 25°C | -2.5 | -2.7 | | | |
| | | | Full range | -2 | | | | |
| A_{VD} | Large-signal differential voltage amplification | $V_O = \pm 2.8\ \text{V}, R_L = 10\ \text{k}\Omega$ | 25°C | 15 | 80 | V/mV | | |
| | | | Full range | 2 | | | | |
| | | $V_O = 0\ \text{to}\ 2\ \text{V}, R_L = 100\ \Omega$ | 25°C | 0.75 | 45 | | | |
| | | | Full range | 0.5 | | | | |
| | | $V_O = 0\ \text{to}\ -2\ \text{V}, R_L = 100\ \Omega$ | 25°C | 0.5 | 3 | | | |
| | | | Full range | 0.15 | | | | |
| r_i | Input resistance | | 25°C | 10^{12} | Ω | | | |
| c_i | Input capacitance | | 25°C | 4 | pF | | | |
| z_o | Open-loop output impedance | $I_O = 0$ | 25°C | 560 | Ω | | | |
| CMRR | Common-mode rejection ratio | $V_{IC} = V_{ICR\text{min}}, R_S = 50\ \Omega$ | 25°C | 65 | 82 | dB | | |
| | | | Full range | 65 | | | | |
| k_{SVR} | Supply-voltage rejection ratio ($\Delta V_{CC\pm} / \Delta V_{IO}$) | $V_{CC\pm} = \pm 5\ \text{V to}\ \pm 15\ \text{V}, R_S = 50\ \Omega$ | 25°C | 75 | 93 | dB | | |
| | | | Full range | 65 | | | | |

† Full range is -40°C to 85°C.

NOTE 4: Typical values are based on the input offset voltage shift observed through 168 hours of operating life test at $T_A = 150^\circ\text{C}$ extrapolated to $T_A = 25^\circ\text{C}$ using the Arrhenius equation and assuming an activation energy of 0.96 eV.



TLE206x, TLE206xA, TLE206xB
EXCALIBUR JFET-INPUT HIGH-OUTPUT-DRIVE
μPOWER OPERATIONAL AMPLIFIERS

SLOS193B – FEBRUARY 1997 – REVISED MAY 2004

TLE2064I electrical characteristics at specified free-air temperature, $V_{CC\pm} = \pm 5\text{ V}$ (unless otherwise noted) (continued)

| PARAMETER | TEST CONDITIONS | T_A^\dagger | TLE2064I TLE2064AI TLE2064BI | | | UNIT |
|------------------------------------------------------------------------------------------|--------------------------------------|---------------|------------------------------------|-----|-----|------|
| | | | MIN | TYP | MAX | |
| I_{CC} Supply current (four amplifiers) | $V_O = 0$, No load | 25°C | 1.12 | 1.3 | mA | |
| | | Full range | 1.3 | | | |
| ΔI_{CC} Supply-current change over operating temperature range (four amplifiers) | | Full range | 108 | | μA | |
| V_{O1}/V_{O2} Crosstalk attenuation | $A_{VD} = 1000$, $f = 1\text{ kHz}$ | 25°C | 120 | | dB | |

† Full range is -40°C to 85°C .

TLE2064I operating characteristics at specified free-air temperature, $V_{CC\pm} = \pm 5\text{ V}$ (unless otherwise noted)

| PARAMETER | TEST CONDITIONS | T_A^\dagger | TLE2064I TLE2064AI TLE2064BI | | | UNIT |
|---------------------------------------------------------|----------------------------------------------------------------------------------------------|---------------|------------------------------------|-----|--------|------|
| | | | MIN | TYP | MAX | |
| SR Slew rate at unity gain (see Figure 1) | $R_L = 10\text{ k}\Omega$, $C_L = 100\text{ pF}$ | 25°C | 2.2 | 3.4 | V/μs | |
| | | Full range | 1.7 | | | |
| V_n Equivalent input noise voltage (see Figure 2) | $f = 10\text{ Hz}$, $R_S = 20\ \Omega$ | 25°C | 59 | | nV/√Hz | |
| | $f = 1\text{ kHz}$, $f = 1\text{ kHz}$ | | 43 | | | |
| $V_{N(PP)}$ Peak-to-peak equivalent input noise voltage | $f = 0.1\text{ Hz}$ to 10 Hz | 25°C | 1.1 | | μV | |
| I_n Equivalent input noise current | $f = 1\text{ kHz}$ | 25°C | 1 | | fA/√Hz | |
| THD Total harmonic distortion | $A_{VD} = 2$, $f = 10\text{ kHz}$, $V_{O(PP)} = 2\text{ V}$, $R_L = 10\text{ k}\Omega$ | 25°C | 0.025% | | | |
| B_1 Unity-gain bandwidth (see Figure 3) | $R_L = 10\text{ k}\Omega$, $C_L = 100\text{ pF}$ | 25°C | 1.8 | | MHz | |
| | $R_L = 100\ \Omega$, $C_L = 100\text{ pF}$ | | 1.3 | | | |
| t_s Settling time | $\epsilon = 0.1\%$ | 25°C | 5 | | μs | |
| | $\epsilon = 0.01\%$ | | 10 | | | |
| B_{OM} Maximum output-swing bandwidth | $A_{VD} = 1$, $R_L = 10\text{ k}\Omega$ | 25°C | 140 | | kHz | |
| ϕ_m Phase margin at unity gain (see Figure 3) | $R_L = 10\text{ k}\Omega$, $C_L = 100\text{ pF}$ | 25°C | 58° | | | |
| | $R_L = 100\ \Omega$, $C_L = 100\text{ pF}$ | | 75° | | | |

† Full range is -40°C to 85°C .

TLE206x, TLE206xA, TLE206xB
EXCALIBUR JFET-INPUT HIGH-OUTPUT-DRIVE
μPOWER OPERATIONAL AMPLIFIERS

SLOS193B – FEBRUARY 1997 – REVISED MAY 2004

TLE2064I electrical characteristics at specified free-air temperature, $V_{CC\pm} = \pm 15\text{ V}$ (unless otherwise noted)

| PARAMETER | | TEST CONDITIONS | T_A † | TLE2064I TLE2064AI TLE2064BI | | | UNIT | |
|----------------|-----------------------------------------------------------------------|-----------------------------------------------------------------------------------|------------|------------------------------------|-----------|----------|------|------------------------------|
| | | | | MIN | TYP | MAX | | |
| V_{IO} | Input offset voltage | $V_{IC} = 0,$ $R_S = 50\ \Omega$ | 25°C | 0.9 | 6 | mV | | |
| | | | Full range | 7.3 | | | | |
| | | | 25°C | 0.9 | 4 | | | |
| | | | Full range | 5.3 | | | | |
| | | | 25°C | 0.7 | 2 | | | |
| | | | Full range | 3.3 | | | | |
| α_{VIO} | Temperature coefficient of input offset voltage | | | 25°C | 6 | | | $\mu\text{V}/^\circ\text{C}$ |
| | Input offset voltage long-term drift (see Note 4) | | | Full range | 0.04 | | | $\mu\text{V}/\text{mo}$ |
| I_{IO} | Input offset current | | 25°C | 2 | | pA | | |
| | | | Full range | 3 | | nA | | |
| I_{IB} | Input bias current | | 25°C | 4 | | pA | | |
| | | | Full range | 5 | | nA | | |
| V_{ICR} | Common-mode input voltage range | | 25°C | -11 to 13 | -12 to 16 | V | | |
| | | | Full range | -11 to 13 | | V | | |
| V_{OM+} | Maximum positive peak output voltage swing | $R_L = 10\ \text{k}\Omega$ | 25°C | 13.2 | 13.7 | V | | |
| | | | Full range | 13 | | | | |
| | | | 25°C | 12.5 | 13.2 | | | |
| | | | Full range | 12 | | | | |
| V_{OM-} | Maximum negative peak output voltage swing | $R_L = 10\ \text{k}\Omega$ | 25°C | -13.2 | -13.7 | V | | |
| | | | Full range | -13 | | | | |
| | | | 25°C | -12.5 | -13 | | | |
| | | | Full range | -12 | | | | |
| A_{VD} | Large-signal differential voltage amplification | $V_O = \pm 10\ \text{V},$ $R_L = 10\ \text{k}\Omega$ | 25°C | 30 | 230 | V/mV | | |
| | | | Full range | 20 | | | | |
| | | $V_O = 0\ \text{to}\ 8\ \text{V},$ $R_L = 600\ \Omega$ | 25°C | 25 | 100 | | | |
| | | | Full range | 10 | | | | |
| | | $V_O = 0\ \text{to}\ -8\ \text{V},$ $R_L = 600\ \Omega$ | 25°C | 3 | 25 | | | |
| | | | Full range | 1 | | | | |
| r_i | Input resistance | | 25°C | 10^{12} | | Ω | | |
| c_i | Input capacitance | | 25°C | 4 | | pF | | |
| z_o | Open-loop output impedance | $I_O = 0$ | 25°C | 560 | | Ω | | |
| CMRR | Common-mode rejection ratio | $V_{IC} = V_{ICR\text{min}},$ $R_S = 50\ \Omega$ | 25°C | 72 | 90 | dB | | |
| | | | Full range | 65 | | | | |
| k_{SVR} | Supply-voltage rejection ratio ($\Delta V_{CC\pm} / \Delta V_{IO}$) | $V_{CC\pm} = \pm 5\ \text{V}\ \text{to}\ \pm 15\ \text{V},$ $R_S = 50\ \Omega$ | 25°C | 75 | 93 | dB | | |
| | | | Full range | 65 | | | | |

† Full range is -40°C to 85°C.

NOTE 4: Typical values are based on the input offset voltage shift observed through 168 hours of operating life test at $T_A = 150^\circ\text{C}$ extrapolated to $T_A = 25^\circ\text{C}$ using the Arrhenius equation and assuming an activation energy of 0.96 eV.



TLE206x, TLE206xA, TLE206xB
EXCALIBUR JFET-INPUT HIGH-OUTPUT-DRIVE
μPOWER OPERATIONAL AMPLIFIERS

SLOS193B – FEBRUARY 1997 – REVISED MAY 2004

TLE2064I electrical characteristics at specified free-air temperature, $V_{CC\pm} = \pm 15$ V (unless otherwise noted) (continued)

| PARAMETER | TEST CONDITIONS | T_A † | TLE2064I TLE2064AI TLE2064BI | | | UNIT |
|------------------------------------------------------------------------------------------|-------------------------------|------------|------------------------------------|-----|-----|------|
| | | | MIN | TYP | MAX | |
| I_{CC} Supply current (four amplifiers) | $V_O = 0$, No load | 25°C | 1.25 | 1.4 | mA | |
| | | Full range | 1.5 | | | |
| ΔI_{CC} Supply-current change over operating temperature range (four amplifiers) | | Full range | 148 | | μA | |
| V_{O1}/V_{O2} Crosstalk attenuation | $A_{VD} = 1000$, $f = 1$ kHz | 25°C | 120 | | dB | |

† Full range is – 40°C to 85°C.

TLE2064I operating characteristics at specified free-air temperature, $V_{CC\pm} = \pm 15$ V

| PARAMETER | TEST CONDITIONS | T_A † | TLE2064I TLE2064AI TLE2064BI | | | UNIT |
|---------------------------------------------------------|------------------------------------------------------------------|------------|------------------------------------|-----|----------------|------|
| | | | MIN | TYP | MAX | |
| SR Slew rate at unity gain (see Figure 1) | $R_L = 10$ kΩ, $C_L = 100$ pF | 25°C | 2.6 | 3.4 | V/μs | |
| | | Full range | 2.1 | | | |
| V_n Equivalent input noise voltage (see Figure 2) | $f = 10$ Hz, $R_S = 20$ Ω, $f = 1$ kHz, $R_S = 20$ Ω | 25°C | 70 | 100 | nV/\sqrt{Hz} | |
| | | | 40 | 60 | | |
| $V_{N(PP)}$ Peak-to-peak equivalent input noise voltage | $f = 0.1$ Hz to 10 Hz | 25°C | 1.1 | | μV | |
| I_n Equivalent input noise current | $f = 1$ kHz | 25°C | 1.1 | | fA/\sqrt{Hz} | |
| THD Total harmonic distortion | $A_{VD} = 2$, $f = 10$ kHz, $R_L = 10$ kΩ $V_{O(PP)} = 2$ V, | 25°C | 0.025% | | | |
| B_1 Unity-gain bandwidth (see Figure 3) | $R_L = 10$ kΩ, $C_L = 100$ pF | 25°C | 2 | | MHz | |
| | $R_L = 600$ Ω, $C_L = 100$ pF | | 1.5 | | | |
| t_s Settling time | $\epsilon = 0.1\%$ | 25°C | 5 | | μs | |
| | $\epsilon = 0.01\%$ | | 10 | | | |
| B_{OM} Maximum output-swing bandwidth | $A_{VD} = 1$, $R_L = 10$ kΩ | 25°C | 40 | | kHz | |
| ϕ_m Phase margin at unity gain (see Figure 3) | $R_L = 10$ kΩ, $C_L = 100$ pF | 25°C | 60° | | | |
| | $R_L = 600$ Ω, $C_L = 100$ pF | | 70° | | | |

† Full range is – 40°C to 85°C.



TLE206x, TLE206xA, TLE206xB
EXCALIBUR JFET-INPUT HIGH-OUTPUT-DRIVE
μPOWER OPERATIONAL AMPLIFIERS

SLOS193B – FEBRUARY 1997 – REVISED MAY 2004

TLE2064M electrical characteristics at specified free-air temperature, $V_{CC\pm} = \pm 5\text{ V}$ (unless otherwise noted)

| PARAMETER | | TEST CONDITIONS | T_A † | TLE2064M TLE2064AM TLE2064BM | | | UNIT |
|----------------|---------------------------------------------------|-----------------------------------------------------|---------------------------------------------------------|------------------------------------|---------|------------------------------|------|
| | | | | MIN | TYP | MAX | |
| V_{IO} | Input offset voltage | $V_{IC} = 0, R_S = 50\ \Omega$ | 25°C | 1.2 | 7 | mV | |
| | | | Full range | 9 | | | |
| | | | 25°C | 1.2 | 6 | | |
| | | | Full range | 8 | | | |
| | | | 25°C | 0.8 | 3.5 | | |
| | | | Full range | 5.5 | | | |
| α_{VIO} | Temperature coefficient of input offset voltage | $V_{IC} = 0, R_S = 50\ \Omega$ | 25°C | 6 | | $\mu\text{V}/^\circ\text{C}$ | |
| | Input offset voltage long-term drift (see Note 4) | | Full range | 0.04 | | $\mu\text{V}/\text{mo}$ | |
| I_{IO} | Input offset current | $V_{IC} = 0, R_S = 50\ \Omega$ | 25°C | 1 | | pA | |
| | | | Full range | 15 | | nA | |
| I_{IB} | Input bias current | $V_{IC} = 0, R_S = 50\ \Omega$ | 25°C | 3 | | pA | |
| | | | Full range | 30 | | nA | |
| V_{ICR} | Common-mode input voltage range | | 25°C | -1.6 to 4 | -2 to 6 | V | |
| | | | Full range | -1.6 to 4 | | V | |
| V_{OM+} | Maximum positive peak output voltage swing | $R_L = 10\ \text{k}\Omega$ | 25°C | 3.5 | 3.7 | V | |
| | | | Full range | 3 | | | |
| | | FK and J packages | $R_L = 600\ \Omega$ | 25°C | 2.5 | | 3.6 |
| | | | | Full range | 2 | | |
| | | D and N packages | $R_L = 100\ \Omega$ | 25°C | 2.5 | | 3.1 |
| | | | | Full range | 2 | | |
| V_{OM-} | Maximum negative peak output voltage swing | $R_L = 10\ \text{k}\Omega$ | 25°C | -3.5 | -3.9 | V | |
| | | | Full range | -3 | | | |
| | | FK and J packages | $R_L = 600\ \Omega$ | 25°C | -2.5 | | -3.5 |
| | | | | Full range | -2 | | |
| | | D and N packages | $R_L = 100\ \Omega$ | 25°C | -2.5 | | -2.7 |
| | | | | Full range | -2 | | |
| A_{VD} | Large-signal differential voltage amplification | $V_O = \pm 2.8\ \text{V}, R_L = 10\ \text{k}\Omega$ | 25°C | 15 | 80 | V/mV | |
| | | | Full range | 2 | | | |
| | | FK and J packages | $V_O = 0\ \text{to}\ 2.5\ \text{V}, R_L = 600\ \Omega$ | 25°C | 1 | | 65 |
| | | | | Full range | 0.5 | | |
| | | | $V_O = 0\ \text{to}\ -2.5\ \text{V}, R_L = 600\ \Omega$ | 25°C | 1 | | 16 |
| | | | | Full range | 0.5 | | |

† Full range is -55°C to 125°C.

NOTE 4: Typical values are based on the input offset voltage shift observed through 168 hours of operating life test at $T_A = 150^\circ\text{C}$ extrapolated to $T_A = 25^\circ\text{C}$ using the Arrhenius equation and assuming an activation energy of 0.96 eV.



TLE206x, TLE206xA, TLE206xB
EXCALIBUR JFET-INPUT HIGH-OUTPUT-DRIVE
μPOWER OPERATIONAL AMPLIFIERS

SLOS193B – FEBRUARY 1997 – REVISED MAY 2004

TLE2064M electrical characteristics at specified free-air temperature, $V_{CC\pm} = \pm 5\text{ V}$ (unless otherwise noted) continued)

| PARAMETER | | TEST CONDITIONS | T_A^\dagger | TLE2064M TLE2064AM TLE2064BM | | | UNIT |
|-----------------|--------------------------------------------------------------------------|---------------------------------------------------------------------------|---------------------------------------|------------------------------------|------|---------------|------|
| | | | | MIN | TYP | MAX | |
| A_{VD} | Large-signal differential voltage amplification | D and N packages | $V_O = 0$ to 2 V, $R_L = 100\ \Omega$ | 25°C | 0.75 | 45 | V/mV |
| | | | | Full range | 0.25 | | |
| | | $V_O = 0$ to -2 V, $R_L = 100\ \Omega$ | 25°C | 0.4 | 3 | | |
| | | | Full range | 0.15 | | | |
| r_i | Input resistance | | 25°C | 10 ¹² | | Ω | |
| c_i | Input capacitance | | 25°C | 4 | | pF | |
| z_o | Open-loop output impedance | $I_O = 0$ | 25°C | 560 | | Ω | |
| CMRR | Common-mode rejection ratio | $V_{IC} = V_{ICRmin}$, $R_S = 50\ \Omega$ | 25°C | 65 | 82 | dB | |
| | | | Full range | 60 | | | |
| k_{SVR} | Supply-voltage rejection ratio ($\Delta V_{CC\pm} / \Delta V_{IO}$) | $V_{CC\pm} = \pm 5\text{ V}$ to $\pm 15\text{ V}$, $R_S = 50\ \Omega$ | 25°C | 75 | 93 | dB | |
| | | | Full range | 65 | | | |
| I_{CC} | Supply current (four amplifiers) | $V_O = 0$, No load | 25°C | 1.12 | 1.3 | mA | |
| | | | Full range | 1.3 | | | |
| ΔI_{CC} | Supply-current change over operating temperature range (four amplifiers) | | Full range | 144 | | μA | |
| | | | | | | | |
| V_{O1}/V_{O2} | Crosstalk attenuation | $A_{VD} = 1000$, $f = 1\text{ kHz}$ | 25°C | 120 | | dB | |

† Full range is -55°C to 125°C.

TLE2064M operating characteristics, $V_{CC\pm} = \pm 5\text{ V}$, $T_A = 25^\circ\text{C}$

| PARAMETER | | TEST CONDITIONS | TLE2064M TLE2064AM TLE2064BM | | | UNIT |
|-------------|-----------------------------------------------|----------------------------------------------------------------------------------------------|------------------------------------|-----|-----|------------------------|
| | | | MIN | TYP | MAX | |
| SR | Slew rate at unity gain (see Figure 1) | $R_L = 10\text{ k}\Omega$, $C_L = 100\text{ pF}$ | 3.4 | | | V/ μs |
| V_n | Equivalent input noise voltage (see Figure 2) | $f = 10\text{ Hz}$, $R_S = 20\ \Omega$ | 59 | | | nV/ $\sqrt{\text{Hz}}$ |
| | | $f = 1\text{ kHz}$, $R_S = 20\ \Omega$ | 43 | | | |
| $V_{N(PP)}$ | Peak-to-peak equivalent input noise voltage | $f = 0.1\text{ Hz}$ to 10 Hz | 1.1 | | | μV |
| I_n | Equivalent input noise current | $f = 1\text{ kHz}$ | 1 | | | fA/ $\sqrt{\text{Hz}}$ |
| THD | Total harmonic distortion | $A_{VD} = 2$, $f = 10\text{ kHz}$, $V_{O(PP)} = 2\text{ V}$, $R_L = 10\text{ k}\Omega$ | 0.025% | | | |
| B_1 | Unity-gain bandwidth (see Figure 3) | $R_L = 10\text{ k}\Omega$, $C_L = 100\text{ pF}$ | 1.8 | | | MHz |
| | | $R_L = 600\ \Omega$, $C_L = 100\text{ pF}$ | 1.3 | | | |
| t_s | Settling time | $\epsilon = 0.1\%$ | 5 | | | μs |
| | | $\epsilon = 0.01\%$ | 10 | | | |
| B_{OM} | Maximum output-swing bandwidth | $A_{VD} = 1$, $R_L = 10\text{ k}\Omega$ | 140 | | | kHz |
| ϕ_m | Phase margin at unity gain (see Figure 3) | $R_L = 10\text{ k}\Omega$, $C_L = 100\text{ pF}$ | 58° | | | |
| | | $R_L = 600\ \Omega$, $C_L = 100\text{ pF}$ | 75° | | | |



TLE206x, TLE206xA, TLE206xB
EXCALIBUR JFET-INPUT HIGH-OUTPUT-DRIVE
μPOWER OPERATIONAL AMPLIFIERS

SLOS193B – FEBRUARY 1997 – REVISED MAY 2004

TLE2064M electrical characteristics at specified free-air temperature, $V_{CC\pm} = \pm 15\text{ V}$ (unless otherwise noted)

| PARAMETER | | TEST CONDITIONS | T_A † | TLE2064M TLE2064AM TLE2064BM | | | UNIT |
|----------------|-----------------------------------------------------------------------|----------------------------------------------------------------------|------------|------------------------------------|-----------|------------------------------|------|
| | | | | MIN | TYP | MAX | |
| V_{IO} | Input offset voltage | $V_{IC} = 0, R_S = 50\ \Omega$ | 25°C | 0.9 | 6 | mV | |
| | | | Full range | | 8 | | |
| | | | 25°C | 0.9 | 4 | | |
| | | | Full range | | 6 | | |
| | | | 25°C | 0.7 | 2 | | |
| | | | Full range | | 4 | | |
| α_{VIO} | Temperature coefficient of input offset voltage | $V_{IC} = 0, R_S = 50\ \Omega$ | 25°C | 6 | | $\mu\text{V}/^\circ\text{C}$ | |
| | Input offset voltage long-term drift (see Note 4) | | Full range | 0.04 | | $\mu\text{V}/\text{mo}$ | |
| I_{IO} | Input offset current | | 25°C | 2 | | pA | |
| | | | Full range | | 20 | nA | |
| I_{IB} | Input bias current | | 25°C | 4 | | pA | |
| | | | Full range | | 40 | nA | |
| V_{ICR} | Common-mode input voltage range | | 25°C | -11 to 13 | -12 to 16 | V | |
| | | | Full range | -11 to 13 | | V | |
| V_{OM+} | Maximum positive peak output voltage swing | $R_L = 10\ \text{k}\Omega$ | 25°C | 13 | 13.7 | V | |
| | | | Full range | 12.5 | | | |
| | | $R_L = 600\ \Omega$ | 25°C | 12.5 | 13.2 | | |
| | | | Full range | 12 | | | |
| V_{OM-} | Maximum negative peak output voltage swing | $R_L = 10\ \text{k}\Omega$ | 25°C | -13 | -13.7 | V | |
| | | | Full range | -12.5 | | | |
| | | $R_L = 600\ \Omega$ | 25°C | -13 | -13 | | |
| | | | Full range | -12.5 | | | |
| A_{VD} | Large-signal differential voltage amplification | $V_O = \pm 10\ \text{V}, R_L = 10\ \text{k}\Omega$ | 25°C | 30 | 230 | V/mV | |
| | | | Full range | 20 | | | |
| | | $V_O = 0\ \text{to}\ 8\ \text{V}, R_L = 600\ \Omega$ | 25°C | 25 | 100 | | |
| | | | Full range | 7 | | | |
| | | $V_O = 0\ \text{to}\ -8\ \text{V}, R_L = 600\ \Omega$ | 25°C | 3 | 25 | | |
| | | | Full range | 1 | | | |
| r_i | Input resistance | | 25°C | 10^{12} | Ω | | |
| c_i | Input capacitance | | 25°C | 4 | pF | | |
| z_o | Open-loop output impedance | $I_O = 0$ | 25°C | 560 | Ω | | |
| CMRR | Common-mode rejection ratio | $V_{IC} = V_{ICRmin}, R_S = 50\ \Omega$ | 25°C | 72 | 90 | dB | |
| | | | Full range | 65 | | | |
| k_{SVR} | Supply-voltage rejection ratio ($\Delta V_{CC\pm} / \Delta V_{IO}$) | $V_{CC\pm} = \pm 5\ \text{V to } \pm 15\ \text{V}, R_S = 50\ \Omega$ | 25°C | 75 | 93 | dB | |
| | | | Full range | 65 | | | |

† Full range is -55°C to 125°C.

NOTE 4: Typical values are based on the input offset voltage shift observed through 168 hours of operating life test at $T_A = 150^\circ\text{C}$ extrapolated to $T_A = 25^\circ\text{C}$ using the Arrhenius equation and assuming an activation energy of 0.96 eV.



TLE206x, TLE206xA, TLE206xB
EXCALIBUR JFET-INPUT HIGH-OUTPUT-DRIVE
μPOWER OPERATIONAL AMPLIFIERS

SLOS193B – FEBRUARY 1997 – REVISED MAY 2004

TLE2064M electrical characteristics at specified free-air temperature, $V_{CC\pm} = \pm 15$ V (unless otherwise noted) (continued)

| PARAMETER | TEST CONDITIONS | T_A † | TLE2064M TLE2064AM TLE2064BM | | | UNIT |
|------------------------------------------------------------------------------------------|-------------------------------|------------|------------------------------------|---------|-----|------|
| | | | MIN | TYP | MAX | |
| I_{CC} Supply current (four amplifiers) | $V_O = 0$, No load | 25°C | 1.25 | 1.4 | mA | |
| | | Full range | 1.5 | | | |
| ΔI_{CC} Supply-current change over operating temperature range (four amplifiers) | | Full range | 194 | μ A | | |
| V_{O1}/V_{O2} Crosstalk attenuation | $A_{VD} = 1000$, $f = 1$ kHz | 25°C | 120 | dB | | |

† Full range is – 55°C to 125°C.

TLE2064M operating characteristics at specified free-air temperature, $V_{CC\pm} = \pm 15$ V

| PARAMETER | TEST CONDITIONS | T_A † | TLE2064M TLE2064AM TLE2064BM | | | UNIT |
|---------------------------------------------------------|--------------------------------------------------------------------------|------------|------------------------------------|-----|----------------|------|
| | | | MIN | TYP | MAX | |
| SR Slew rate at unity gain (see Figure 1) | $R_L = 10$ k Ω , $C_L = 100$ pF | 25°C | 2.6 | 3.4 | V/μ s | |
| | | Full range | 1.8 | | | |
| V_n Equivalent input noise voltage (see Figure 2) | $f = 10$ Hz, $R_S = 20$ Ω | 25°C | 70 | | nV/\sqrt{Hz} | |
| | $f = 1$ kHz, $R_S = 20$ Ω | | 40 | | | |
| $V_{N(PP)}$ Peak-to-peak equivalent input noise voltage | $f = 0.1$ Hz to 10 Hz | 25°C | 1.1 | | μ V | |
| I_n Equivalent input noise current | $f = 1$ kHz | 25°C | 1.1 | | fA/\sqrt{Hz} | |
| THD Total harmonic distortion | $A_{VD} = 2$, $f = 10$ kHz, $V_{O(PP)} = 2$ V, $R_L = 10$ k Ω | 25°C | 0.025% | | | |
| B_1 Unity-gain bandwidth (see Figure 3) | $R_L = 10$ k Ω , $C_L = 100$ pF | 25°C | 2 | | MHz | |
| | $R_L = 600$ Ω , $C_L = 100$ pF | | 1.5 | | | |
| t_s Settling time | $\epsilon = 0.1\%$ | 25°C | 5 | | μ s | |
| | $\epsilon = 0.01\%$ | | 10 | | | |
| B_{OM} Maximum output-swing bandwidth | $A_{VD} = 1$, $R_L = 10$ k Ω | 25°C | 40 | | kHz | |
| ϕ_m Phase margin at unity gain (see Figure 3) | $R_L = 10$ k Ω , $C_L = 100$ pF | 25°C | 60° | | | |
| | $R_L = 600$ Ω , $C_L = 100$ pF | | 70° | | | |

† Full range is – 55°C to 125°C.

TLE206x, TLE206xA, TLE206xB EXCALIBUR JFET-INPUT HIGH-OUTPUT-DRIVE μPOWER OPERATIONAL AMPLIFIERS

SLOS193B – FEBRUARY 1997 – REVISED MAY 2004

TLE2064Y electrical characteristics at $V_{CC\pm} = \pm 15\text{ V}$, $T_A = 25^\circ\text{C}$ (unless otherwise noted)

| PARAMETER | TEST CONDITIONS | TLE2064Y | | | UNIT |
|---------------------------------------------------------------------------------|------------------------------------------------------------------------------------|-----------------|-----------------|-----|-------------------------|
| | | MIN | TYP | MAX | |
| V_{IO} Input offset voltage | $V_{IC} = 0$, $R_S = 50\ \Omega$ | | 0.9 | 6 | mV |
| ∞V_{IO} Input offset voltage long-term drift (see Note 4) | | | 0.04 | | $\mu\text{V}/\text{mo}$ |
| I_{IO} Input offset current | | | 2 | | pA |
| I_{IB} Input bias current | | | 4 | | pA |
| V_{ICR} Common-mode input voltage range | | -11 to 13 | -12 to 16 | | V |
| V_{OM+} Maximum positive peak output voltage swing | $R_L = 10\ \text{k}\Omega$ | 13.2 | 13.7 | | V |
| | $R_L = 600\ \Omega$ | 12.5 | 13.2 | | |
| V_{OM-} Maximum negative peak output voltage swing | $R_L = 10\ \text{k}\Omega$ | -13.2 | -13.7 | | V |
| | $R_L = 600\ \Omega$ | 12.5 | 13 | | V |
| A_{VD} Large-signal differential voltage amplification | $V_O = \pm 10\ \text{V}$, $R_L = 10\ \text{k}\Omega$ | 30 | 230 | | V/mV |
| | $V_O = 0\ \text{to}\ 8\ \text{V}$, $R_L = 600\ \Omega$ | 25 | 100 | | |
| | $V_O = 0\ \text{to}\ -8\ \text{V}$, $R_L = 600\ \Omega$ | 3 | 25 | | |
| r_i Input resistance | | | 10^{12} | | Ω |
| c_i Input capacitance | | | 4 | | pF |
| z_o Open-loop output impedance | $I_O = 0$ | | 560 | | Ω |
| CMRR Common-mode rejection ratio | $R_S = 50\ \Omega$, $V_{IC} = V_{ICR\text{min}}$ | 72 | 90 | | dB |
| k_{SVR} Supply-voltage rejection ratio ($\Delta V_{CC\pm} / \Delta V_{IO}$) | $V_{CC\pm} = \pm 5\ \text{V}\ \text{to}\ \pm 15\ \text{V}$, $R_S = 50\ \Omega$ | 75 | 93 | | dB |
| I_{CC} Supply current | $V_O = 0$, No load | | 1.25 | 1.4 | mA |
| V_{O1}/V_{O2} Crosstalk attenuation | $A_{VD} = 1000$, $f = 1\ \text{kHz}$ | | 120 | | dB |

NOTE 4: Typical values are based on the input offset voltage shift observed through 168 hours of operating life test at $T_A = 150^\circ\text{C}$ extrapolated to $T_A = 25^\circ\text{C}$ using the Arrhenius equation and assuming an activation energy of 0.96 eV.

TLE2064Y operating characteristics at $V_{CC\pm} = \pm 15\ \text{V}$, $T_A = 25^\circ\text{C}$

| PARAMETER | TEST CONDITIONS | TLE2064Y | | | UNIT |
|---------------------------------------------------------|-------------------------------------------------------------------------------------------------|----------|--------|-----|------------------------|
| | | MIN | TYP | MAX | |
| SR Slew rate at unity gain (see Figure 1) | $R_L = 10\ \text{k}\Omega$, $C_L = 100\ \text{pF}$ | 2.6 | 3.4 | | V/ μs |
| V_n Equivalent input noise voltage (see Figure 2) | $f = 10\ \text{Hz}$, $R_S = 20\ \Omega$ | | 70 | | nV/ $\sqrt{\text{Hz}}$ |
| | $f = 1\ \text{kHz}$, $R_S = 20\ \Omega$ | | 40 | | |
| $V_{N(PP)}$ Peak-to-peak equivalent input noise voltage | $f = 0.1\ \text{Hz}\ \text{to}\ 10\ \text{Hz}$ | | 1.1 | | μV |
| I_n Equivalent input noise current | $f = 1\ \text{kHz}$ | | 1.1 | | fA/ $\sqrt{\text{Hz}}$ |
| THD Total harmonic distortion | $A_{VD} = 2$, $f = 10\ \text{kHz}$, $V_{O(PP)} = 2\ \text{V}$, $R_L = 10\ \text{k}\Omega$ | | 0.025% | | |
| B_1 Unity-gain bandwidth (see Figure 3) | $R_L = 10\ \text{k}\Omega$, $C_L = 100\ \text{pF}$ | | 2 | | MHz |
| | $R_L = 600\ \Omega$, $C_L = 100\ \text{pF}$ | | 1.5 | | |
| t_s Settling time | $\epsilon = 0.1\%$ | | 5 | | μs |
| | $\epsilon = 0.01\%$ | | 10 | | |
| BOM Maximum output-swing bandwidth | $A_{VD} = 1$, $R_L = 10\ \text{k}\Omega$ | | 40 | | kHz |
| ϕ_m Phase margin at unity gain (see Figure 3) | $R_L = 10\ \text{k}\Omega$, $C_L = 100\ \text{pF}$ | | 60° | | |
| | $R_L = 600\ \Omega$, $C_L = 100\ \text{pF}$ | | 70° | | |



PARAMETER MEASUREMENT INFORMATION



NOTE A: C_L includes fixture capacitance.

Figure 1. Slew-Rate Test Circuit

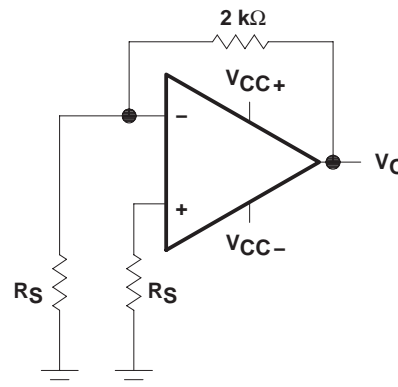
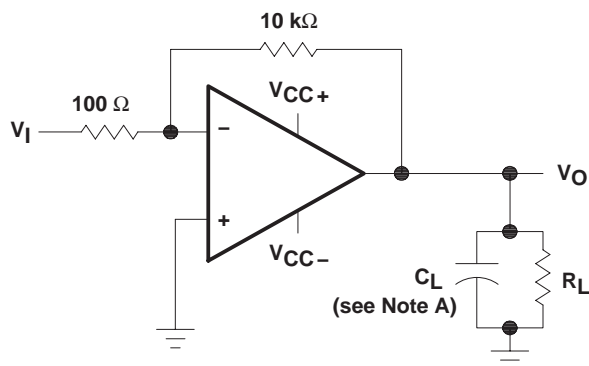

Figure 2. Noise-Voltage Test Circuit



NOTE A: C_L includes fixture capacitance.

Figure 3. Unity-Gain Bandwidth and Phase-Margin Test Circuit

typical values

Typical values presented in this data sheet represent the median (50% point) of device parametric performance.

input bias and offset current

At the picoampere bias current level typical of the TLE206x, TLE2064xA, and TLE206xB, accurate measurement of the bias current becomes difficult. Not only does this measurement require a picoammeter, but test socket leakages can easily exceed the actual device bias currents. To accurately measure these small currents, Texas Instruments uses a two-step process. The socket leakage is measured using picoammeters with bias voltages applied but with no device in the socket. The device is then inserted into the socket and a second test that measures both the socket leakage and the device input bias current is performed. The two measurements are then subtracted algebraically to determine the bias current of the device.

TLE206x, TLE206xA, TLE206xB
EXCALIBUR JFET-INPUT HIGH-OUTPUT-DRIVE
μPOWER OPERATIONAL AMPLIFIERS

SLOS193B – FEBRUARY 1997 – REVISED MAY 2004

TYPICAL CHARACTERISTICS

Table of Graphs

| | | FIGURE | |
|-------------|-------------------------------------------------|------------------------------|------------|
| V_{IO} | Input offset voltage | Distribution | 4, 5, 6 |
| I_{IB} | Input bias current | vs Common-mode input voltage | 7 |
| | | vs Free-air temperature | 8 |
| I_{IO} | Input offset current | vs Free-air temperature | 8 |
| V_{ICR} | Common-mode input voltage | vs Free-air temperature | 9 |
| V_{OM} | Maximum peak output voltage | vs Output current | 10, 11 |
| | | vs Supply voltage | 12, 13, 14 |
| $V_{O(PP)}$ | Maximum peak-to-peak output voltage | vs Frequency | 15, 16 |
| | | vs Load resistance | 17 |
| A_{VD} | Large-signal differential voltage amplification | vs Frequency | 18 |
| | | vs Free-air temperature | 19 |
| I_{OS} | Short-circuit output current | vs Elapsed time | 20 |
| | | vs Free-air temperature | 21 |
| Z_o | Output impedance | vs Frequency | 22, 23 |
| $CMRR$ | Common-mode rejection ratio | vs Frequency | 24 |
| I_{CC} | Supply current | vs Supply voltage | 25, 26, 27 |
| | | vs Free-air temperature | 28, 29, 30 |
| | Voltage-follower small-signal pulse response | vs Time | 31, 32 |
| | Voltage-follower large-signal pulse response | vs Time | 33, 34 |
| | Noise voltage (referred to input) | 0.1 to 10 Hz | 35 |
| V_n | Equivalent input noise voltage | vs Frequency | 36 |
| THD | Total harmonic distortion | vs Frequency | 37, 38 |
| B_1 | Unity-gain bandwidth | vs Supply voltage | 39 |
| | | vs Free-air temperature | 40 |
| ϕ_m | Phase margin | vs Supply voltage | 41 |
| | | vs Load capacitance | 42 |
| | | vs Free-air temperature | 43 |
| | Phase shift | vs Frequency | 18 |



TYPICAL CHARACTERISTICS

TLE2061
 DISTRIBUTION OF
 INPUT OFFSET VOLTAGE

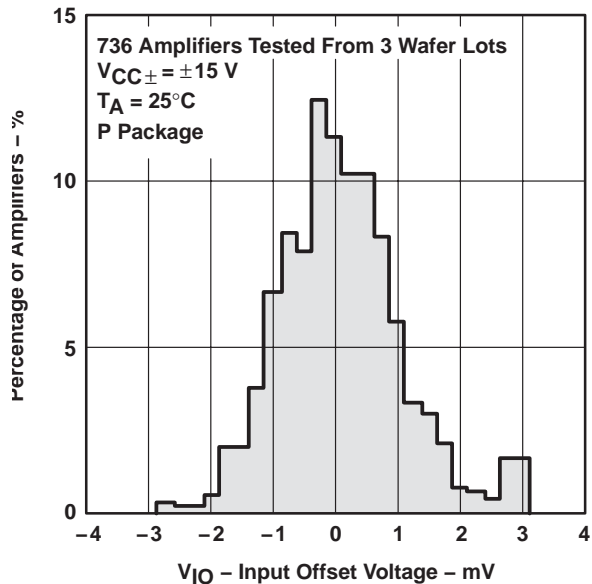

Figure 4

TLE2062
 DISTRIBUTION OF
 INPUT OFFSET VOLTAGE



Figure 5

TLE2064
 DISTRIBUTION OF
 INPUT OFFSET VOLTAGE

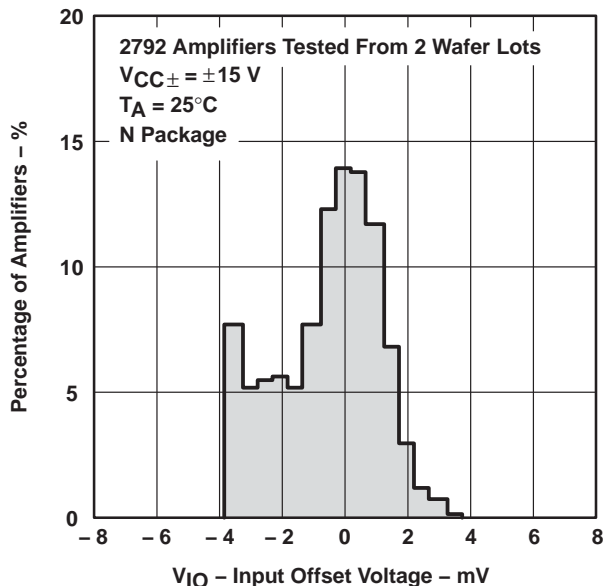

Figure 6

INPUT BIAS CURRENT
 vs
 COMMON-MODE INPUT VOLTAGE

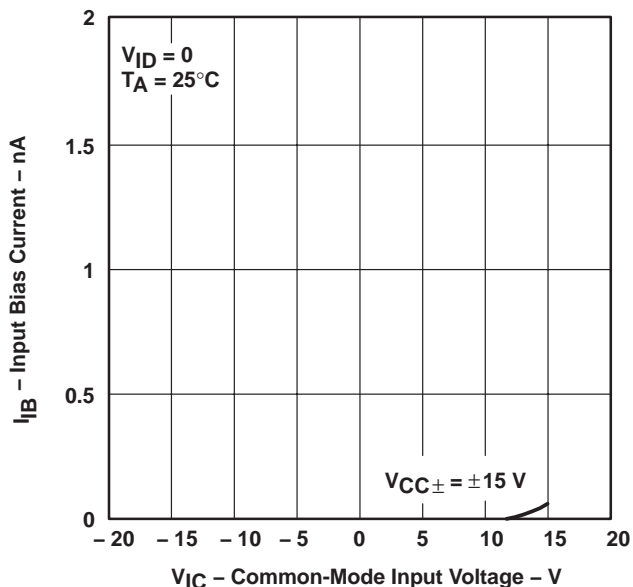

Figure 7

TLE206x, TLE206xA, TLE206xB
EXCALIBUR JFET-INPUT HIGH-OUTPUT-DRIVE
μPOWER OPERATIONAL AMPLIFIERS

SLOS193B – FEBRUARY 1997 – REVISED MAY 2004

TYPICAL CHARACTERISTICS†

**INPUT BIAS CURRENT
 AND INPUT OFFSET CURRENT
 vs
 FREE-AIR TEMPERATURE**

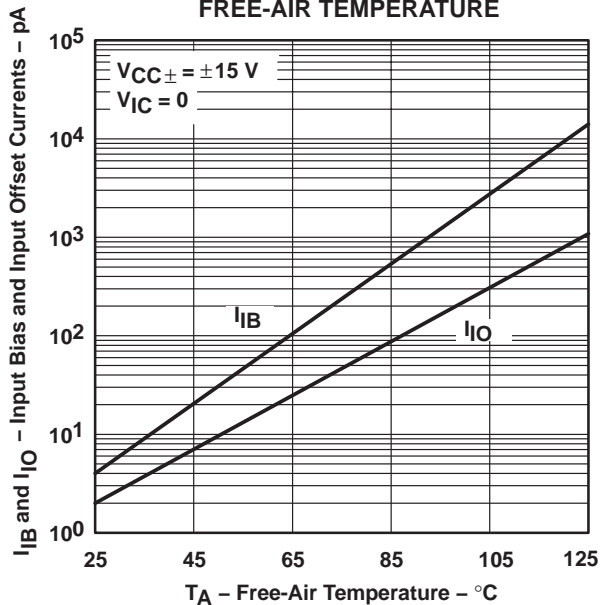

Figure 8

**COMMON-MODE INPUT VOLTAGE
 vs
 FREE-AIR TEMPERATURE**

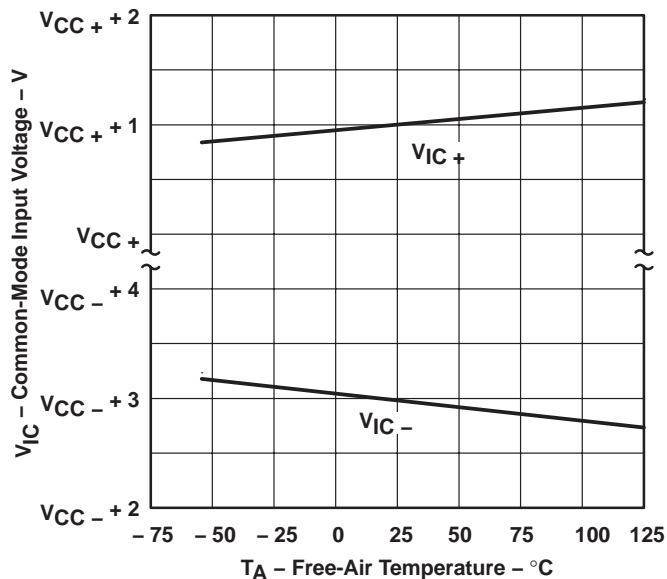

Figure 9

**MAXIMUM POSITIVE PEAK
 OUTPUT VOLTAGE
 vs
 OUTPUT CURRENT**

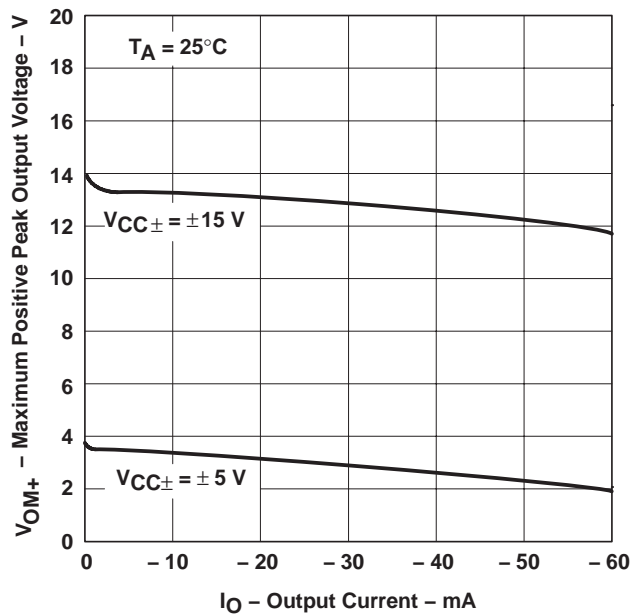

Figure 10

**MAXIMUM NEGATIVE PEAK
 OUTPUT VOLTAGE
 vs
 OUTPUT CURRENT**

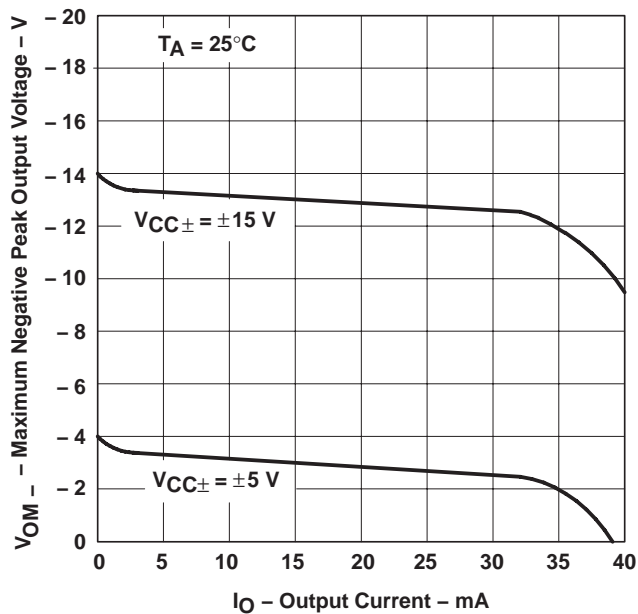

Figure 11

† Data at high and low temperatures are applicable only within the rated operating free-air temperature ranges of the various devices.



TYPICAL CHARACTERISTICS



Figure 12



Figure 13



Figure 14

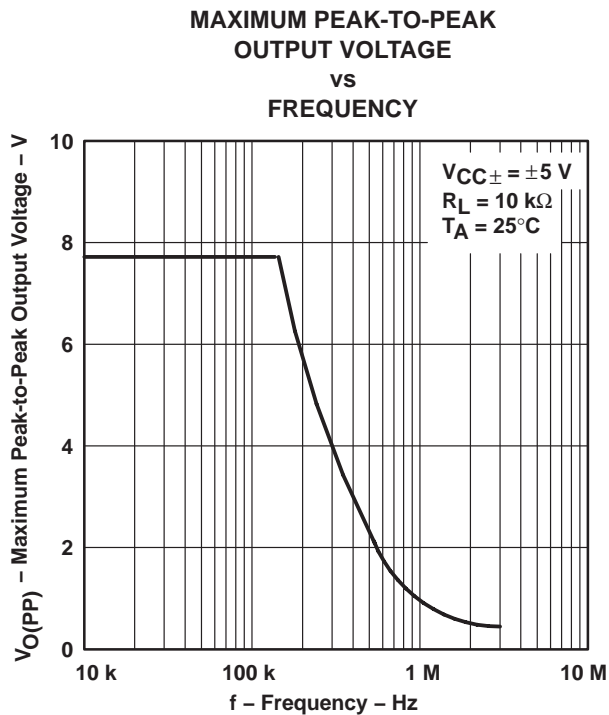

Figure 15

TYPICAL CHARACTERISTICS†

**MAXIMUM PEAK-TO-PEAK
 OUTPUT VOLTAGE
 vs
 FREQUENCY**

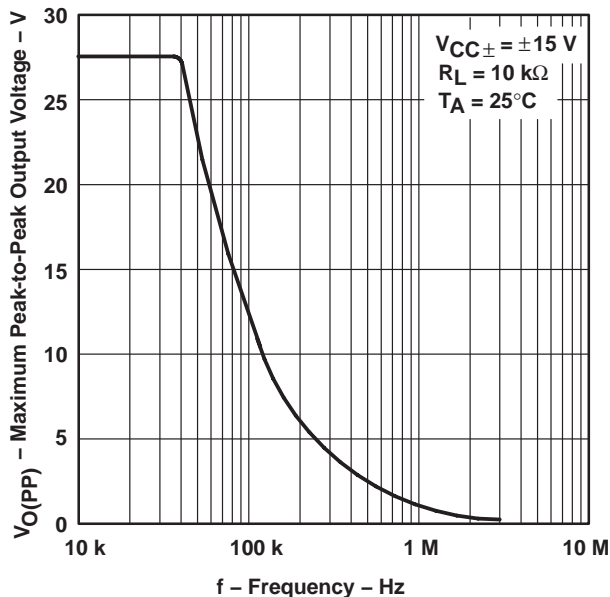

Figure 16

**MAXIMUM PEAK-TO-PEAK
 OUTPUT VOLTAGE
 vs
 LOAD RESISTANCE**

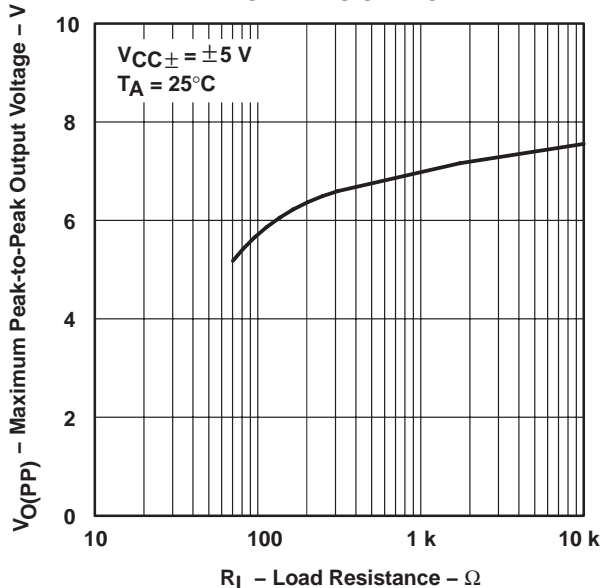

Figure 17

**LARGE-SIGNAL DIFFERENTIAL VOLTAGE
 AMPLIFICATION AND PHASE SHIFT
 vs
 FREQUENCY**

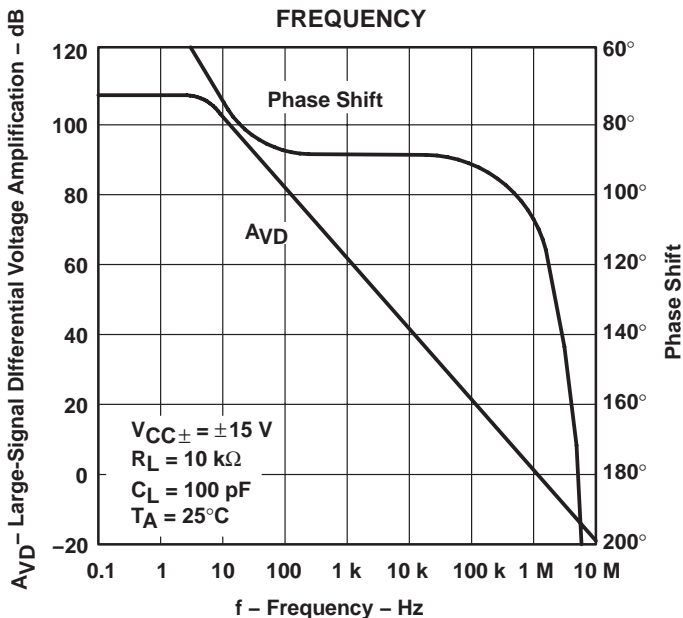

Figure 18

**LARGE-SIGNAL VOLTAGE AMPLIFICATION
 vs
 FREE-AIR TEMPERATURE**

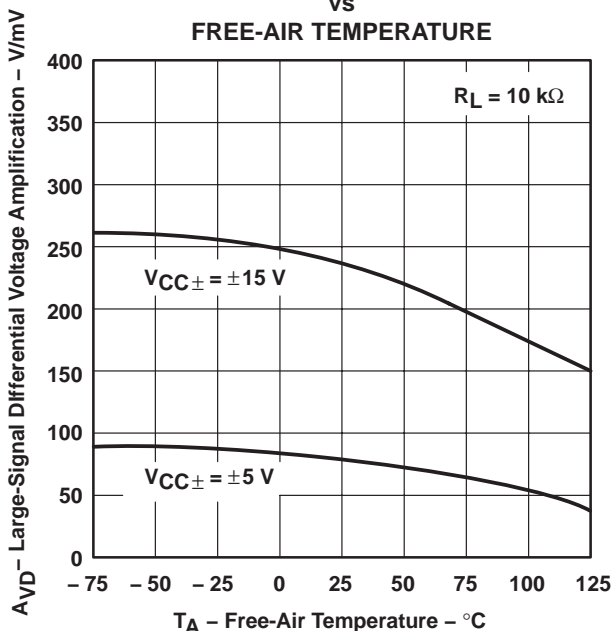

Figure 19

† Data at high and low temperatures are applicable only within the rated operating free-air temperature ranges of the various devices.

TYPICAL CHARACTERISTICS†



Figure 20



Figure 21

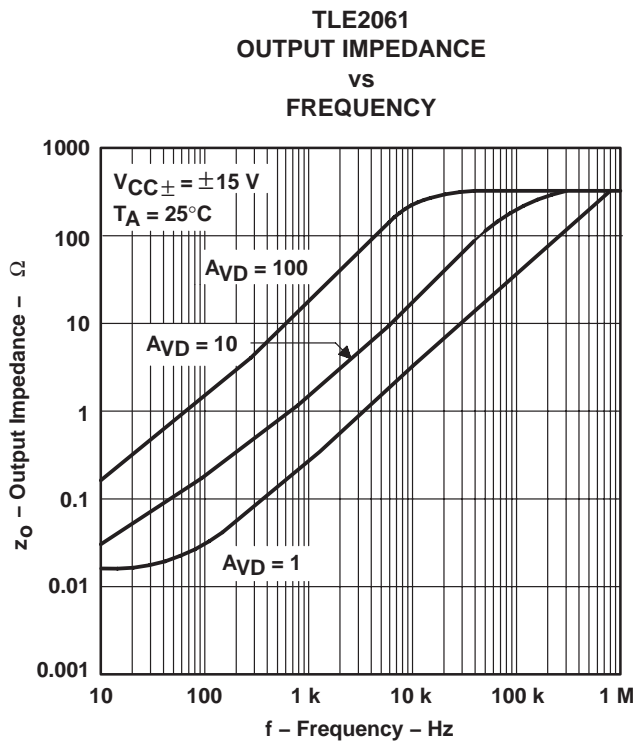

Figure 22

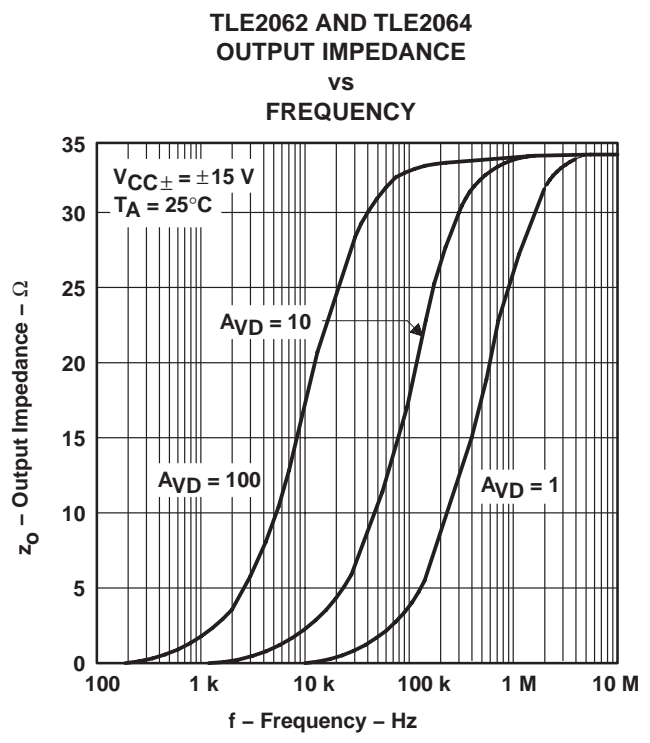

Figure 23

† Data at high and low temperatures are applicable only within the rated operating free-air temperature ranges of the various devices.

TLE206x, TLE206xA, TLE206xB
EXCALIBUR JFET-INPUT HIGH-OUTPUT-DRIVE
μPOWER OPERATIONAL AMPLIFIERS

SLOS193B – FEBRUARY 1997 – REVISED MAY 2004

TYPICAL CHARACTERISTICS†

COMMON-MODE REJECTION RATIO
vs
FREQUENCY

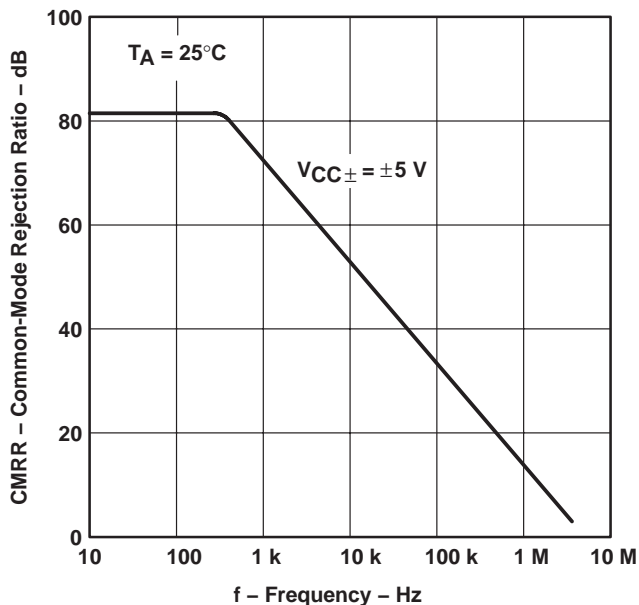

Figure 24

TLE2061
SUPPLY CURRENT
vs
SUPPLY VOLTAGE

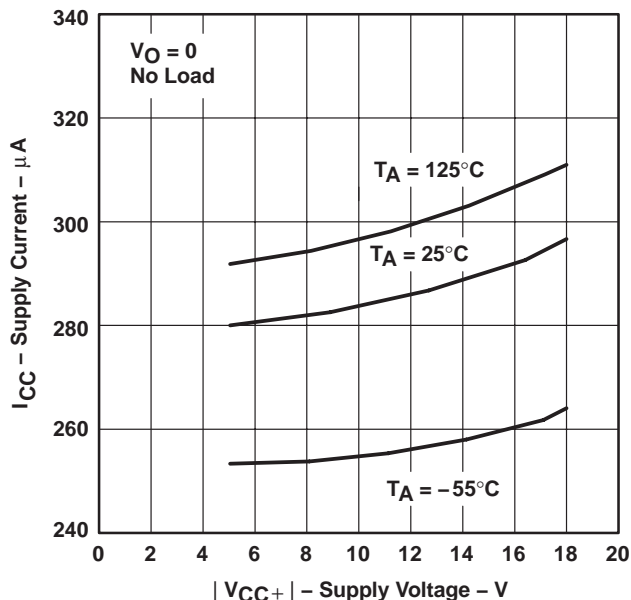

Figure 25

TLE2062
SUPPLY CURRENT
vs
SUPPLY VOLTAGE

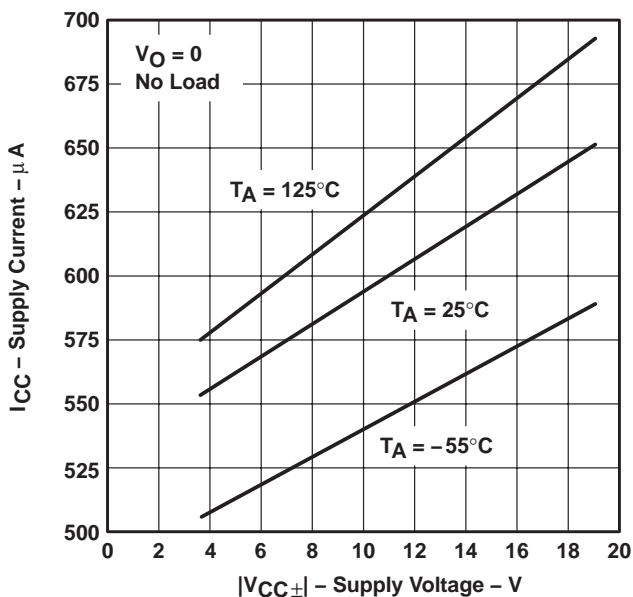

Figure 26

TLE2064
SUPPLY CURRENT
vs
SUPPLY VOLTAGE

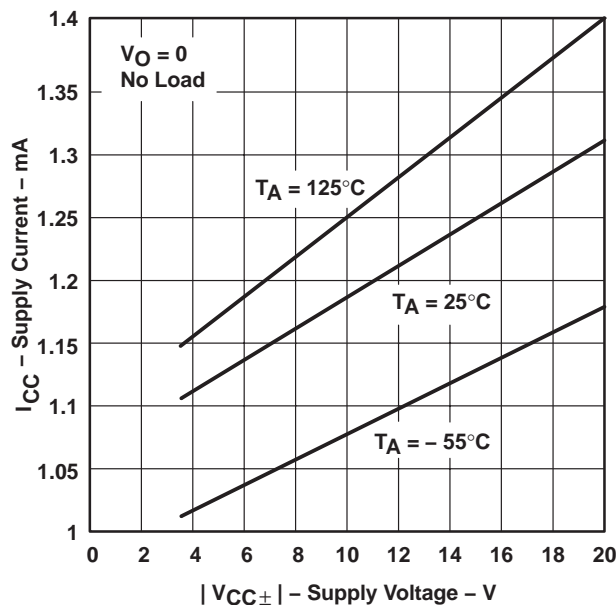

Figure 27

† Data at high and low temperatures are applicable only within the rated operating free-air temperature ranges of the various devices.



TYPICAL CHARACTERISTICS†

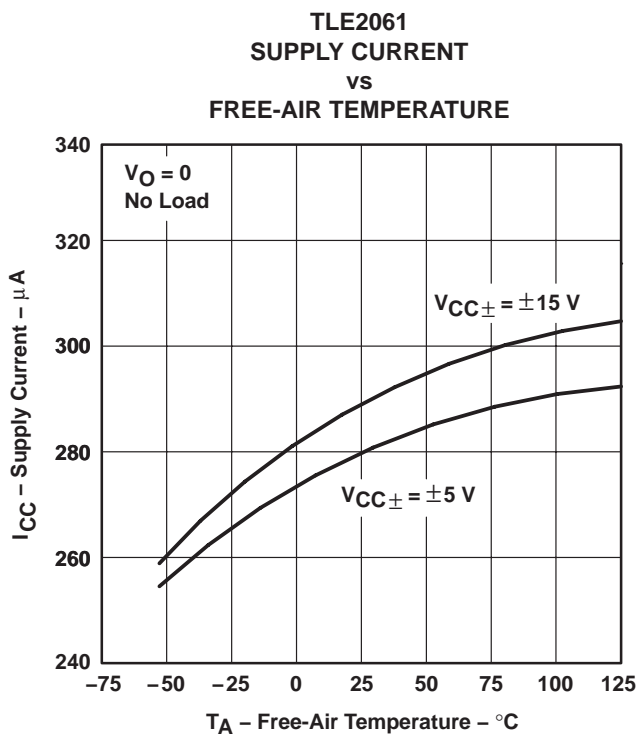

Figure 28

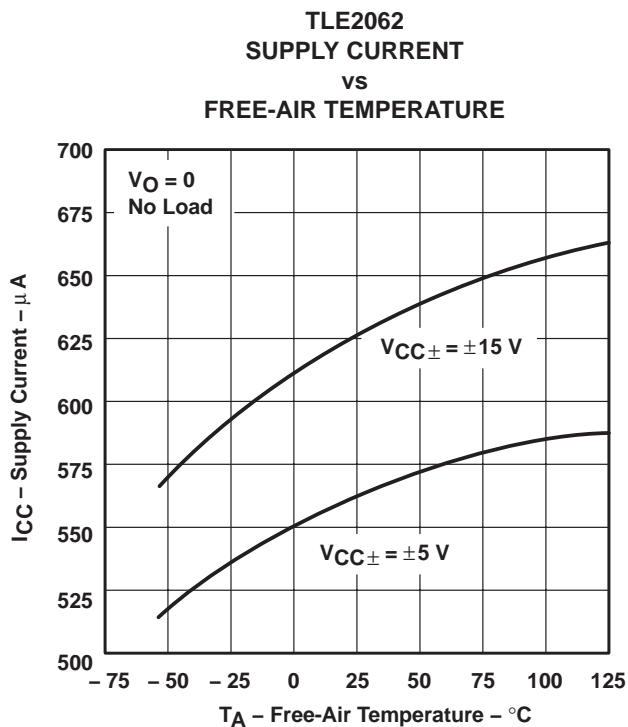

Figure 29

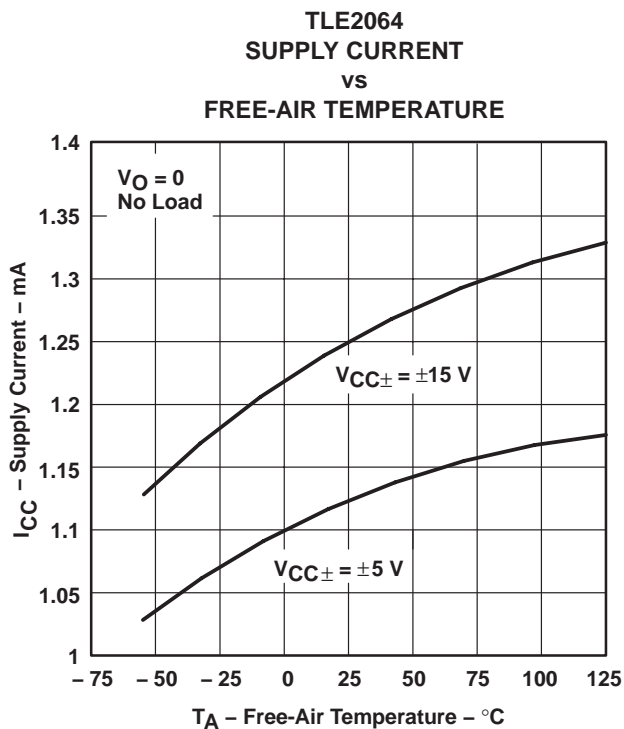

Figure 30

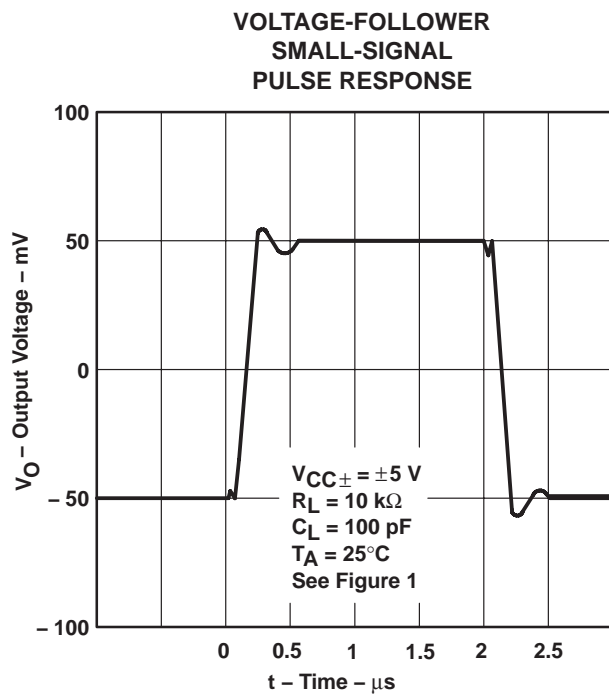

Figure 31

† Data at high and low temperatures are applicable only within the rated operating free-air temperature ranges of the various devices.

TYPICAL CHARACTERISTICS

**VOLTAGE-FOLLOWER
 SMALL-SIGNAL
 PULSE RESPONSE**



Figure 32

**VOLTAGE-FOLLOWER
 LARGE-SIGNAL
 PULSE RESPONSE**



Figure 33

**VOLTAGE-FOLLOWER
 LARGE-SIGNAL
 PULSE RESPONSE**



Figure 34

**NOISE VOLTAGE
 (REFERRED TO INPUT)
 0.1 TO 10 Hz**

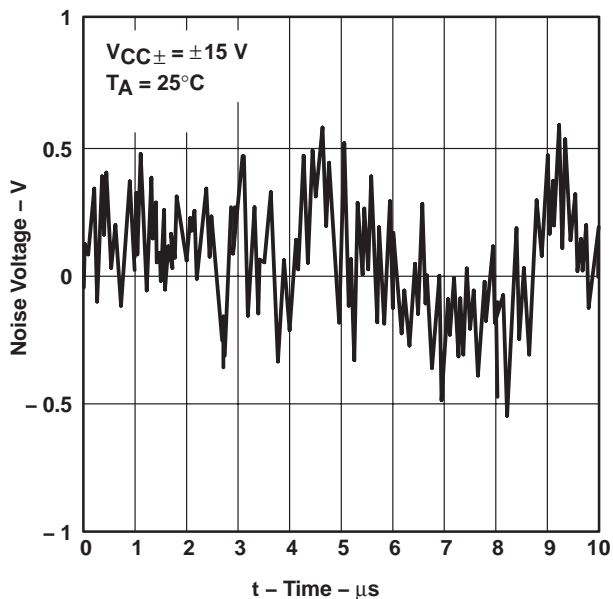

Figure 35

TYPICAL CHARACTERISTICS

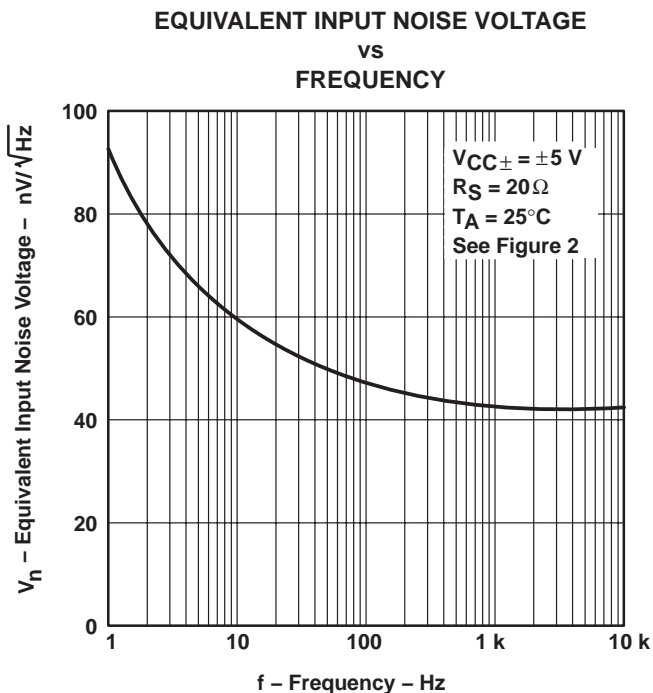

Figure 36

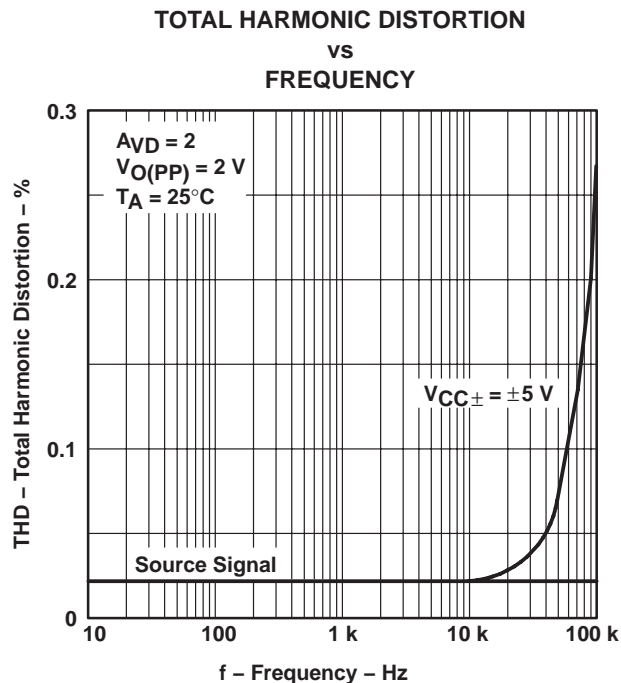

Figure 37

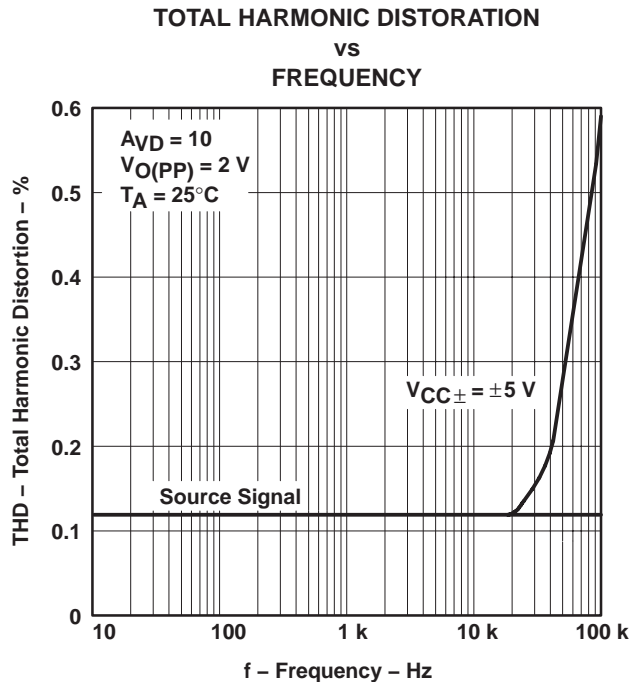

Figure 38

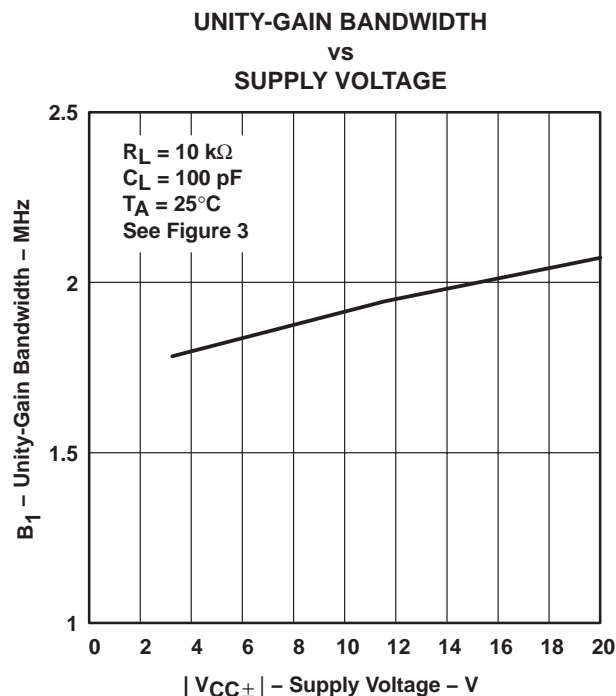

Figure 39

TLE206x, TLE206xA, TLE206xB
EXCALIBUR JFET-INPUT HIGH-OUTPUT-DRIVE
μPOWER OPERATIONAL AMPLIFIERS

SLOS193B – FEBRUARY 1997 – REVISED MAY 2004

TYPICAL CHARACTERISTICS†

UNITY-GAIN BANDWIDTH
vs
FREE-AIR TEMPERATURE



Figure 40

PHASE MARGIN
vs
SUPPLY VOLTAGE



Figure 41

PHASE MARGIN
vs
LOAD CAPACITANCE



Figure 42

PHASE MARGIN
vs
FREE-AIR TEMPERATURE



Figure 43

† Data at high and low temperatures are applicable only within the rated operating free-air temperature ranges of the various devices.



APPLICATION INFORMATION

input characteristics

The TLE206x, TLE206xA, and TLE206xB are specified with a minimum and a maximum input voltage that if exceeded at either input could cause the device to malfunction. Because of the extremely high input impedance and resulting low bias current requirements, the TLE206x, TLE206xA, and TLE206xB are well suited for low-level signal processing. However, leakage currents on printed-circuit boards and sockets can easily exceed bias current requirements and cause degradation in system performance. It is good practice to include guard rings around inputs (see Figure 44). These guards should be driven from a low-impedance source at the same voltage level as the common-mode input.



Figure 44. Use of Guard Rings

TLE2061 input offset voltage nulling

The TLE2061 series offers external null pins that can be used to further reduce the input offset voltage. The circuit of Figure 45 can be connected as shown if the feature is desired. When external nulling is not needed, the null pins may be left unconnected.

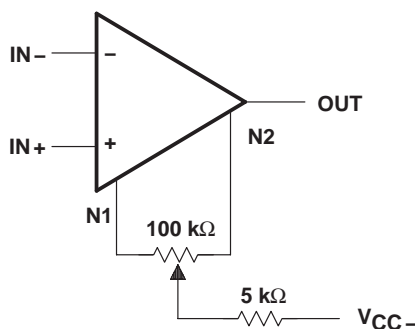

Figure 45. Input Offset Voltage Nulling

PACKAGING INFORMATION

| Orderable Device | Status (1) | Package Type | Package Drawing | Pins | Package Qty | Eco Plan (2) | Lead finish/ Ball material (6) | MSL Peak Temp (3) | Op Temp (°C) | Device Marking (4/5) | Samples |
|------------------|---------------|--------------|-----------------|------|-------------|----------------------|--------------------------------------|----------------------|--------------|-------------------------------------|-------------------------|
| 5962-9080701M2A | ACTIVE | LCCC | FK | 20 | 55 | Non-RoHS & Green | SNPB | N / A for Pkg Type | -55 to 125 | 5962-9080701M2A TLE2061MFKB | Samples |
| 5962-9080701MPA | ACTIVE | CDIP | JG | 8 | 50 | Non-RoHS & Green | SNPB | N / A for Pkg Type | -55 to 125 | 9080701MPA TLE2061M | Samples |
| 5962-9080702Q2A | ACTIVE | LCCC | FK | 20 | 55 | Non-RoHS & Green | SNPB | N / A for Pkg Type | -55 to 125 | 5962-9080702Q2A TLE2061 AMFKB | Samples |
| 5962-9080702QPA | ACTIVE | CDIP | JG | 8 | 50 | Non-RoHS & Green | SNPB | N / A for Pkg Type | -55 to 125 | 9080702QPA TLE2061AM | Samples |
| 5962-9080703QPA | ACTIVE | CDIP | JG | 8 | 50 | Non-RoHS & Green | SNPB | N / A for Pkg Type | -55 to 125 | 9080703QPA TLE2061BM | Samples |
| 5962-9080801MPA | ACTIVE | CDIP | JG | 8 | 50 | Non-RoHS & Green | SNPB | N / A for Pkg Type | -55 to 125 | 9080801MPA TLE2062M | Samples |
| 5962-9080803QPA | ACTIVE | CDIP | JG | 8 | 50 | Non-RoHS & Green | SNPB | N / A for Pkg Type | -55 to 125 | 9080803QPA TLE2062BM | Samples |
| 5962-9080901M2A | ACTIVE | LCCC | FK | 20 | 55 | Non-RoHS & Green | SNPB | N / A for Pkg Type | -55 to 125 | 5962-9080901M2A TLE2064 MFKB | Samples |
| 5962-9080901MCA | ACTIVE | CDIP | J | 14 | 25 | Non-RoHS & Green | SNPB | N / A for Pkg Type | -55 to 125 | 5962-9080901MC A TLE2064MJB | Samples |
| 5962-9080902M2A | ACTIVE | LCCC | FK | 20 | 55 | Non-RoHS & Green | SNPB | N / A for Pkg Type | -55 to 125 | 5962-9080902M2A TLE2064A MFKB | Samples |
| 5962-9080902MDA | ACTIVE | CFP | W | 14 | 25 | Non-RoHS & Non-Green | SNPB | N / A for Pkg Type | -55 to 125 | 5962-9080902MD A TLE2064AMWB | Samples |
| 5962-9080903Q2A | ACTIVE | LCCC | FK | 20 | 55 | Non-RoHS & Green | SNPB | N / A for Pkg Type | -55 to 125 | 5962-9080903Q2A TLE2064 BMFKB | Samples |

| Orderable Device | Status (1) | Package Type | Package Drawing | Pins | Package Qty | Eco Plan (2) | Lead finish/ Ball material (6) | MSL Peak Temp (3) | Op Temp (°C) | Device Marking (4/5) | Samples |
|------------------|---------------|--------------|-----------------|------|-------------|------------------|--------------------------------------|----------------------|--------------|-----------------------------------------|-------------------------|
| 5962-9080903QCA | ACTIVE | CDIP | J | 14 | 25 | Non-RoHS & Green | SNPB | N / A for Pkg Type | -55 to 125 | 5962-9080903QC A TLE2064BMJB | Samples |
| TLE2061ACD | OBSOLETE | SOIC | D | 8 | | TBD | Call TI | Call TI | 0 to 70 | 2061AC | |
| TLE2061ACP | ACTIVE | PDIP | P | 8 | 50 | RoHS & Green | NIPDAU | N / A for Pkg Type | 0 to 70 | TLE2061AC | Samples |
| TLE2061ACPE4 | ACTIVE | PDIP | P | 8 | 50 | TBD | Call TI | Call TI | 0 to 70 | | Samples |
| TLE2061AID | OBSOLETE | SOIC | D | 8 | | TBD | Call TI | Call TI | -40 to 85 | 2061AI | |
| TLE2061AIP | ACTIVE | PDIP | P | 8 | 50 | RoHS & Green | NIPDAU | N / A for Pkg Type | -40 to 85 | TLE2061AI | Samples |
| TLE2061AMFKB | ACTIVE | LCCC | FK | 20 | 55 | Non-RoHS & Green | SNPB | N / A for Pkg Type | -55 to 125 | 5962- 9080702Q2A TLE2061 AMFKB | Samples |
| TLE2061AMJGB | ACTIVE | CDIP | JG | 8 | 50 | Non-RoHS & Green | SNPB | N / A for Pkg Type | -55 to 125 | 9080702QPA TLE2061AM | Samples |
| TLE2061BMJGB | ACTIVE | CDIP | JG | 8 | 50 | Non-RoHS & Green | SNPB | N / A for Pkg Type | -55 to 125 | 9080703QPA TLE2061BM | Samples |
| TLE2061CD | OBSOLETE | SOIC | D | 8 | | TBD | Call TI | Call TI | 0 to 70 | 2061C | |
| TLE2061CDR | ACTIVE | SOIC | D | 8 | 2500 | RoHS & Green | NIPDAU | Level-1-260C-UNLIM | 0 to 70 | 2061C | Samples |
| TLE2061CDRG4 | ACTIVE | SOIC | D | 8 | 2500 | TBD | Call TI | Call TI | 0 to 70 | | Samples |
| TLE2061CP | ACTIVE | PDIP | P | 8 | 50 | RoHS & Green | NIPDAU | N / A for Pkg Type | 0 to 70 | TLE2061CP | Samples |
| TLE2061ID | OBSOLETE | SOIC | D | 8 | | TBD | Call TI | Call TI | -40 to 85 | 2061I | |
| TLE2061IDR | ACTIVE | SOIC | D | 8 | 2500 | RoHS & Green | NIPDAU | Level-1-260C-UNLIM | -40 to 85 | 2061I | Samples |
| TLE2061IP | ACTIVE | PDIP | P | 8 | 50 | RoHS & Green | NIPDAU | N / A for Pkg Type | -40 to 85 | TLE2061IP | Samples |
| TLE2061MD | OBSOLETE | SOIC | D | 8 | | TBD | Call TI | Call TI | -55 to 125 | 2061M | |
| TLE2061MDG4 | OBSOLETE | SOIC | D | 8 | | TBD | Call TI | Call TI | -55 to 125 | 2061M | |
| TLE2061MFKB | ACTIVE | LCCC | FK | 20 | 55 | Non-RoHS & Green | SNPB | N / A for Pkg Type | -55 to 125 | 5962- 9080701M2A TLE2061MFKB | Samples |
| TLE2061MJGB | ACTIVE | CDIP | JG | 8 | 50 | Non-RoHS & Green | SNPB | N / A for Pkg Type | -55 to 125 | 9080701MPA TLE2061M | Samples |

| Orderable Device | Status (1) | Package Type | Package Drawing | Pins | Package Qty | Eco Plan (2) | Lead finish/ Ball material (6) | MSL Peak Temp (3) | Op Temp (°C) | Device Marking (4/5) | Samples |
|------------------|---------------|--------------|-----------------|------|-------------|------------------|--------------------------------------|----------------------|--------------|------------------------------------|---------|
| TLE2062ACD | OBSOLETE | SOIC | D | 8 | | TBD | Call TI | Call TI | 0 to 70 | 2062AC | |
| TLE2062ACDR | ACTIVE | SOIC | D | 8 | 2500 | RoHS & Green | NIPDAU | Level-1-260C-UNLIM | 0 to 70 | 2062AC | Samples |
| TLE2062AID | OBSOLETE | SOIC | D | 8 | | TBD | Call TI | Call TI | -40 to 85 | 2062AI | |
| TLE2062AIDR | ACTIVE | SOIC | D | 8 | 2500 | RoHS & Green | NIPDAU | Level-1-260C-UNLIM | -40 to 85 | 2062AI | Samples |
| TLE2062AMD | OBSOLETE | SOIC | D | 8 | | TBD | Call TI | Call TI | -55 to 125 | 2062AM | |
| TLE2062AMDR | ACTIVE | SOIC | D | 8 | 2500 | RoHS & Green | NIPDAU | Level-1-260C-UNLIM | -55 to 125 | 2062AM | Samples |
| TLE2062AMJG | ACTIVE | CDIP | JG | 8 | 50 | Non-RoHS & Green | SNPB | N / A for Pkg Type | -55 to 125 | TLE2062 AMJG | Samples |
| TLE2062BMJG | ACTIVE | CDIP | JG | 8 | 50 | Non-RoHS & Green | SNPB | N / A for Pkg Type | -55 to 125 | TLE2062 BMJG | Samples |
| TLE2062BMJGB | ACTIVE | CDIP | JG | 8 | 50 | Non-RoHS & Green | SNPB | N / A for Pkg Type | -55 to 125 | 9080803QPA TLE2062BM | Samples |
| TLE2062CD | OBSOLETE | SOIC | D | 8 | | TBD | Call TI | Call TI | 0 to 70 | 2062C | |
| TLE2062CDR | ACTIVE | SOIC | D | 8 | 2500 | RoHS & Green | NIPDAU | Level-1-260C-UNLIM | 0 to 70 | 2062C | Samples |
| TLE2062CDRG4 | ACTIVE | SOIC | D | 8 | 2500 | TBD | Call TI | Call TI | 0 to 70 | | Samples |
| TLE2062CP | ACTIVE | PDIP | P | 8 | 50 | RoHS & Green | NIPDAU | N / A for Pkg Type | 0 to 70 | TLE2062CP | Samples |
| TLE2062ID | OBSOLETE | SOIC | D | 8 | | TBD | Call TI | Call TI | -40 to 85 | 2062I | |
| TLE2062IDR | ACTIVE | SOIC | D | 8 | 2500 | RoHS & Green | NIPDAU | Level-1-260C-UNLIM | -40 to 85 | 2062I | Samples |
| TLE2062IP | ACTIVE | PDIP | P | 8 | 50 | RoHS & Green | NIPDAU | N / A for Pkg Type | -40 to 85 | TLE2062IP | Samples |
| TLE2062MFKB | OBSOLETE | LCCC | FK | 20 | | TBD | Call TI | Call TI | | 5962- 9080801M2A TLE2062MFKB | |
| TLE2062MJG | ACTIVE | CDIP | JG | 8 | 50 | Non-RoHS & Green | SNPB | N / A for Pkg Type | -55 to 125 | TLE2062MJG | Samples |
| TLE2062MJGB | ACTIVE | CDIP | JG | 8 | 50 | Non-RoHS & Green | SNPB | N / A for Pkg Type | -55 to 125 | 9080801MPA TLE2062M | Samples |
| TLE2064ACD | OBSOLETE | SOIC | D | 14 | | TBD | Call TI | Call TI | 0 to 70 | 2064AC | |
| TLE2064ACDR | ACTIVE | SOIC | D | 14 | 2500 | RoHS & Green | NIPDAU | Level-1-260C-UNLIM | | 2064AC | Samples |

| Orderable Device | Status (1) | Package Type | Package Drawing | Pins | Package Qty | Eco Plan (2) | Lead finish/ Ball material (6) | MSL Peak Temp (3) | Op Temp (°C) | Device Marking (4/5) | Samples |
|------------------|---------------|--------------|-----------------|------|-------------|-------------------------|--------------------------------------|----------------------|--------------|-----------------------------------------|-------------------------|
| TLE2064ACN | ACTIVE | PDIP | N | 14 | 25 | RoHS & Green | NIPDAU | N / A for Pkg Type | | TLE2064ACN | Samples |
| TLE2064AID | OBSOLETE | SOIC | D | 14 | | TBD | Call TI | Call TI | -40 to 85 | 2064AI | |
| TLE2064AIDR | ACTIVE | SOIC | D | 14 | 2500 | RoHS & Green | NIPDAU | Level-1-260C-UNLIM | | 2064AI | Samples |
| TLE2064AMD | OBSOLETE | SOIC | D | 14 | | TBD | Call TI | Call TI | -55 to 125 | 2064AM | |
| TLE2064AMDG4 | OBSOLETE | SOIC | D | 14 | | TBD | Call TI | Call TI | | 2064AM | |
| TLE2064AMDR | ACTIVE | SOIC | D | 14 | 2500 | RoHS & Green | NIPDAU | Level-1-260C-UNLIM | -55 to 125 | 2064AM | Samples |
| TLE2064AMDRG4 | OBSOLETE | SOIC | D | 14 | | TBD | Call TI | Call TI | | 2064AM | |
| TLE2064AMFKB | ACTIVE | LCCC | FK | 20 | 55 | Non-RoHS & Green | SNPB | N / A for Pkg Type | -55 to 125 | 5962- 9080902M2A TLE2064A MFKB | Samples |
| TLE2064AMJ | ACTIVE | CDIP | J | 14 | 25 | Non-RoHS & Green | SNPB | N / A for Pkg Type | -55 to 125 | TLE2064AMJ | Samples |
| TLE2064AMWB | ACTIVE | CFP | W | 14 | 25 | Non-RoHS & Non-Green | SNPB | N / A for Pkg Type | -55 to 125 | 5962-9080902MD A TLE2064AMWB | Samples |
| TLE2064BMFKB | ACTIVE | LCCC | FK | 20 | 55 | Non-RoHS & Green | SNPB | N / A for Pkg Type | -55 to 125 | 5962- 9080903Q2A TLE2064 BMFKB | Samples |
| TLE2064BMJ | ACTIVE | CDIP | J | 14 | 25 | Non-RoHS & Green | SNPB | N / A for Pkg Type | -55 to 125 | TLE2064BMJ | Samples |
| TLE2064BMJB | ACTIVE | CDIP | J | 14 | 25 | Non-RoHS & Green | SNPB | N / A for Pkg Type | -55 to 125 | 5962-9080903QC A TLE2064BMJB | Samples |
| TLE2064CD | OBSOLETE | SOIC | D | 14 | | TBD | Call TI | Call TI | 0 to 70 | TLE2064C | |
| TLE2064CDR | ACTIVE | SOIC | D | 14 | 2500 | RoHS & Green | NIPDAU | Level-1-260C-UNLIM | 0 to 70 | TLE2064C | Samples |
| TLE2064CDRG4 | ACTIVE | SOIC | D | 14 | 2500 | TBD | Call TI | Call TI | 0 to 70 | | Samples |
| TLE2064CN | ACTIVE | PDIP | N | 14 | 25 | RoHS & Green | NIPDAU | N / A for Pkg Type | 0 to 70 | TLE2064CN | Samples |
| TLE2064CNE4 | ACTIVE | PDIP | N | 14 | 25 | TBD | Call TI | Call TI | 0 to 70 | | Samples |
| TLE2064ID | OBSOLETE | SOIC | D | 14 | | TBD | Call TI | Call TI | -40 to 85 | TLE2064I | |

| Orderable Device | Status (1) | Package Type | Package Drawing | Pins | Package Qty | Eco Plan (2) | Lead finish/ Ball material (6) | MSL Peak Temp (3) | Op Temp (°C) | Device Marking (4/5) | Samples |
|------------------|---------------|--------------|-----------------|------|-------------|------------------|--------------------------------------|----------------------|--------------|------------------------------------|-------------------------|
| TLE2064IDR | ACTIVE | SOIC | D | 14 | 2500 | RoHS & Green | NIPDAU | Level-1-260C-UNLIM | -40 to 85 | TLE2064I | Samples |
| TLE2064IN | ACTIVE | PDIP | N | 14 | 25 | RoHS & Green | NIPDAU | N / A for Pkg Type | -40 to 85 | TLE2064IN | Samples |
| TLE2064INE4 | ACTIVE | PDIP | N | 14 | 25 | TBD | Call TI | Call TI | -40 to 85 | | Samples |
| TLE2064MD | OBSOLETE | SOIC | D | 14 | | TBD | Call TI | Call TI | -55 to 125 | TLE2064M | |
| TLE2064MDG4 | OBSOLETE | SOIC | D | 14 | | TBD | Call TI | Call TI | | T2064M | |
| TLE2064MDR | ACTIVE | SOIC | D | 14 | 2500 | RoHS & Green | NIPDAU | Level-1-260C-UNLIM | -55 to 125 | TLE2064M | Samples |
| TLE2064MFKB | ACTIVE | LCCC | FK | 20 | 55 | Non-RoHS & Green | SNPB | N / A for Pkg Type | -55 to 125 | 5962-9080901M2A TLE2064 MFKB | Samples |
| TLE2064MJ | ACTIVE | CDIP | J | 14 | 25 | Non-RoHS & Green | SNPB | N / A for Pkg Type | -55 to 125 | TLE2064MJ | Samples |
| TLE2064MJB | ACTIVE | CDIP | J | 14 | 25 | Non-RoHS & Green | SNPB | N / A for Pkg Type | -55 to 125 | 5962-9080901MC A TLE2064MJB | Samples |

(1) The marketing status values are defined as follows:

ACTIVE: Product device recommended for new designs.

LIFEBUY: TI has announced that the device will be discontinued, and a lifetime-buy period is in effect.

NRND: Not recommended for new designs. Device is in production to support existing customers, but TI does not recommend using this part in a new design.

PREVIEW: Device has been announced but is not in production. Samples may or may not be available.

OBSOLETE: TI has discontinued the production of the device.

(2) **RoHS:** TI defines "RoHS" to mean semiconductor products that are compliant with the current EU RoHS requirements for all 10 RoHS substances, including the requirement that RoHS substance do not exceed 0.1% by weight in homogeneous materials. Where designed to be soldered at high temperatures, "RoHS" products are suitable for use in specified lead-free processes. TI may reference these types of products as "Pb-Free".

RoHS Exempt: TI defines "RoHS Exempt" to mean products that contain lead but are compliant with EU RoHS pursuant to a specific EU RoHS exemption.

Green: TI defines "Green" to mean the content of Chlorine (Cl) and Bromine (Br) based flame retardants meet JS709B low halogen requirements of <=1000ppm threshold. Antimony trioxide based flame retardants must also meet the <=1000ppm threshold requirement.

(3) MSL, Peak Temp. - The Moisture Sensitivity Level rating according to the JEDEC industry standard classifications, and peak solder temperature.

(4) There may be additional marking, which relates to the logo, the lot trace code information, or the environmental category on the device.

(5) Multiple Device Markings will be inside parentheses. Only one Device Marking contained in parentheses and separated by a "~" will appear on a device. If a line is indented then it is a continuation of the previous line and the two combined represent the entire Device Marking for that device.

(6) Lead finish/Ball material - Orderable Devices may have multiple material finish options. Finish options are separated by a vertical ruled line. Lead finish/Ball material values may wrap to two lines if the finish value exceeds the maximum column width.

Important Information and Disclaimer:The information provided on this page represents TI's knowledge and belief as of the date that it is provided. TI bases its knowledge and belief on information provided by third parties, and makes no representation or warranty as to the accuracy of such information. Efforts are underway to better integrate information from third parties. TI has taken and continues to take reasonable steps to provide representative and accurate information but may not have conducted destructive testing or chemical analysis on incoming materials and chemicals. TI and TI suppliers consider certain information to be proprietary, and thus CAS numbers and other limited information may not be available for release.

In no event shall TI's liability arising out of such information exceed the total purchase price of the TI part(s) at issue in this document sold by TI to Customer on an annual basis.

OTHER QUALIFIED VERSIONS OF TLE2061, TLE2061A, TLE2061AM, TLE2061M, TLE2062, TLE2062A, TLE2062AM, TLE2062M, TLE2064, TLE2064A, TLE2064AM, TLE2064M :

- Catalog : [TLE2061A](#), [TLE2061](#), [TLE2062A](#), [TLE2062](#), [TLE2064A](#), [TLE2064](#)
- Military : [TLE2061M](#), [TLE2061AM](#), [TLE2062M](#), [TLE2062AM](#), [TLE2064M](#), [TLE2064AM](#)

NOTE: Qualified Version Definitions:

- Catalog - TI's standard catalog product
- Military - QML certified for Military and Defense Applications

TAPE AND REEL INFORMATION

QUADRANT ASSIGNMENTS FOR PIN 1 ORIENTATION IN TAPE

*All dimensions are nominal

| Device | Package Type | Package Drawing | Pins | SPQ | Reel Diameter (mm) | Reel Width W1 (mm) | A0 (mm) | B0 (mm) | K0 (mm) | P1 (mm) | W (mm) | Pin1 Quadrant |
|-------------|--------------|-----------------|------|------|--------------------|--------------------|---------|---------|---------|---------|--------|---------------|
| TLE2061CDR | SOIC | D | 8 | 2500 | 330.0 | 12.4 | 6.4 | 5.2 | 2.1 | 8.0 | 12.0 | Q1 |
| TLE2061IDR | SOIC | D | 8 | 2500 | 330.0 | 12.4 | 6.4 | 5.2 | 2.1 | 8.0 | 12.0 | Q1 |
| TLE2062ACDR | SOIC | D | 8 | 2500 | 330.0 | 12.4 | 6.4 | 5.2 | 2.1 | 8.0 | 12.0 | Q1 |
| TLE2062AIDR | SOIC | D | 8 | 2500 | 330.0 | 12.4 | 6.4 | 5.2 | 2.1 | 8.0 | 12.0 | Q1 |
| TLE2062AMDR | SOIC | D | 8 | 2500 | 330.0 | 12.4 | 6.4 | 5.2 | 2.1 | 8.0 | 12.0 | Q1 |
| TLE2062CDR | SOIC | D | 8 | 2500 | 330.0 | 12.4 | 6.4 | 5.2 | 2.1 | 8.0 | 12.0 | Q1 |
| TLE2062IDR | SOIC | D | 8 | 2500 | 330.0 | 12.4 | 6.4 | 5.2 | 2.1 | 8.0 | 12.0 | Q1 |
| TLE2064ACDR | SOIC | D | 14 | 2500 | 330.0 | 16.4 | 6.5 | 9.0 | 2.1 | 8.0 | 16.0 | Q1 |
| TLE2064ACDR | SOIC | D | 14 | 2500 | 330.0 | 16.4 | 6.5 | 9.0 | 2.1 | 8.0 | 16.0 | Q1 |
| TLE2064AIDR | SOIC | D | 14 | 2500 | 330.0 | 16.4 | 6.5 | 9.0 | 2.1 | 8.0 | 16.0 | Q1 |
| TLE2064AIDR | SOIC | D | 14 | 2500 | 330.0 | 16.4 | 6.5 | 9.0 | 2.1 | 8.0 | 16.0 | Q1 |
| TLE2064AMDR | SOIC | D | 14 | 2500 | 330.0 | 16.4 | 6.5 | 9.0 | 2.1 | 8.0 | 16.0 | Q1 |
| TLE2064CDR | SOIC | D | 14 | 2500 | 330.0 | 16.4 | 6.5 | 9.0 | 2.1 | 8.0 | 16.0 | Q1 |
| TLE2064IDR | SOIC | D | 14 | 2500 | 330.0 | 16.4 | 6.5 | 9.0 | 2.1 | 8.0 | 16.0 | Q1 |
| TLE2064MDR | SOIC | D | 14 | 2500 | 330.0 | 16.4 | 6.5 | 9.0 | 2.1 | 8.0 | 16.0 | Q1 |

TAPE AND REEL BOX DIMENSIONS



*All dimensions are nominal

| Device | Package Type | Package Drawing | Pins | SPQ | Length (mm) | Width (mm) | Height (mm) |
|-------------|--------------|-----------------|------|------|-------------|------------|-------------|
| TLE2061CDR | SOIC | D | 8 | 2500 | 353.0 | 353.0 | 32.0 |
| TLE2061IDR | SOIC | D | 8 | 2500 | 353.0 | 353.0 | 32.0 |
| TLE2062ACDR | SOIC | D | 8 | 2500 | 356.0 | 356.0 | 35.0 |
| TLE2062AIDR | SOIC | D | 8 | 2500 | 353.0 | 353.0 | 32.0 |
| TLE2062AMDR | SOIC | D | 8 | 2500 | 350.0 | 350.0 | 43.0 |
| TLE2062CDR | SOIC | D | 8 | 2500 | 353.0 | 353.0 | 32.0 |
| TLE2062IDR | SOIC | D | 8 | 2500 | 356.0 | 356.0 | 35.0 |
| TLE2064ACDR | SOIC | D | 14 | 2500 | 350.0 | 350.0 | 43.0 |
| TLE2064ACDR | SOIC | D | 14 | 2500 | 353.0 | 353.0 | 32.0 |
| TLE2064AIDR | SOIC | D | 14 | 2500 | 356.0 | 356.0 | 35.0 |
| TLE2064AIDR | SOIC | D | 14 | 2500 | 350.0 | 350.0 | 43.0 |
| TLE2064AMDR | SOIC | D | 14 | 2500 | 350.0 | 350.0 | 43.0 |
| TLE2064CDR | SOIC | D | 14 | 2500 | 353.0 | 353.0 | 32.0 |
| TLE2064IDR | SOIC | D | 14 | 2500 | 353.0 | 353.0 | 32.0 |
| TLE2064MDR | SOIC | D | 14 | 2500 | 350.0 | 350.0 | 43.0 |

TUBE

*All dimensions are nominal

| Device | Package Name | Package Type | Pins | SPQ | L (mm) | W (mm) | T (μm) | B (mm) |
|-----------------|--------------|--------------|------|-----|--------|--------|--------|--------|
| 5962-9080701M2A | FK | LCCC | 20 | 55 | 506.98 | 12.06 | 2030 | NA |
| 5962-9080702Q2A | FK | LCCC | 20 | 55 | 506.98 | 12.06 | 2030 | NA |
| 5962-9080901M2A | FK | LCCC | 20 | 55 | 506.98 | 12.06 | 2030 | NA |
| 5962-9080902M2A | FK | LCCC | 20 | 55 | 506.98 | 12.06 | 2030 | NA |
| 5962-9080902MDA | W | CFP | 14 | 25 | 506.98 | 26.16 | 6220 | NA |
| 5962-9080903Q2A | FK | LCCC | 20 | 55 | 506.98 | 12.06 | 2030 | NA |
| TLE2061ACP | P | PDIP | 8 | 50 | 506 | 13.97 | 11230 | 4.32 |
| TLE2061AIP | P | PDIP | 8 | 50 | 506 | 13.97 | 11230 | 4.32 |
| TLE2061AMFKB | FK | LCCC | 20 | 55 | 506.98 | 12.06 | 2030 | NA |
| TLE2061CP | P | PDIP | 8 | 50 | 506 | 13.97 | 11230 | 4.32 |
| TLE2061IP | P | PDIP | 8 | 50 | 506 | 13.97 | 11230 | 4.32 |
| TLE2061MFKB | FK | LCCC | 20 | 55 | 506.98 | 12.06 | 2030 | NA |
| TLE2062CP | P | PDIP | 8 | 50 | 506 | 13.97 | 11230 | 4.32 |
| TLE2062IP | P | PDIP | 8 | 50 | 506 | 13.97 | 11230 | 4.32 |
| TLE2064ACN | N | PDIP | 14 | 25 | 506 | 13.97 | 11230 | 4.32 |
| TLE2064AMFKB | FK | LCCC | 20 | 55 | 506.98 | 12.06 | 2030 | NA |
| TLE2064AMWB | W | CFP | 14 | 25 | 506.98 | 26.16 | 6220 | NA |
| TLE2064BMFKB | FK | LCCC | 20 | 55 | 506.98 | 12.06 | 2030 | NA |
| TLE2064CN | N | PDIP | 14 | 25 | 506 | 13.97 | 11230 | 4.32 |
| TLE2064IN | N | PDIP | 14 | 25 | 506 | 13.97 | 11230 | 4.32 |
| TLE2064MFKB | FK | LCCC | 20 | 55 | 506.98 | 12.06 | 2030 | NA |

PACKAGE OUTLINE

JG0008A

CDIP - 5.08 mm max height

CERAMIC DUAL IN-LINE PACKAGE



NOTES:

1. All linear dimensions are in millimeters. Any dimensions in parenthesis are for reference only. Dimensioning and tolerancing per ASME Y14.5M.
2. This drawing is subject to change without notice.
3. This package can be hermetically sealed with a ceramic lid using glass frit.
4. Index point is provided on cap for terminal identification.
5. Falls within MIL STD 1835 GDIP1-T8

EXAMPLE BOARD LAYOUT

JG0008A

CDIP - 5.08 mm max height

CERAMIC DUAL IN-LINE PACKAGE

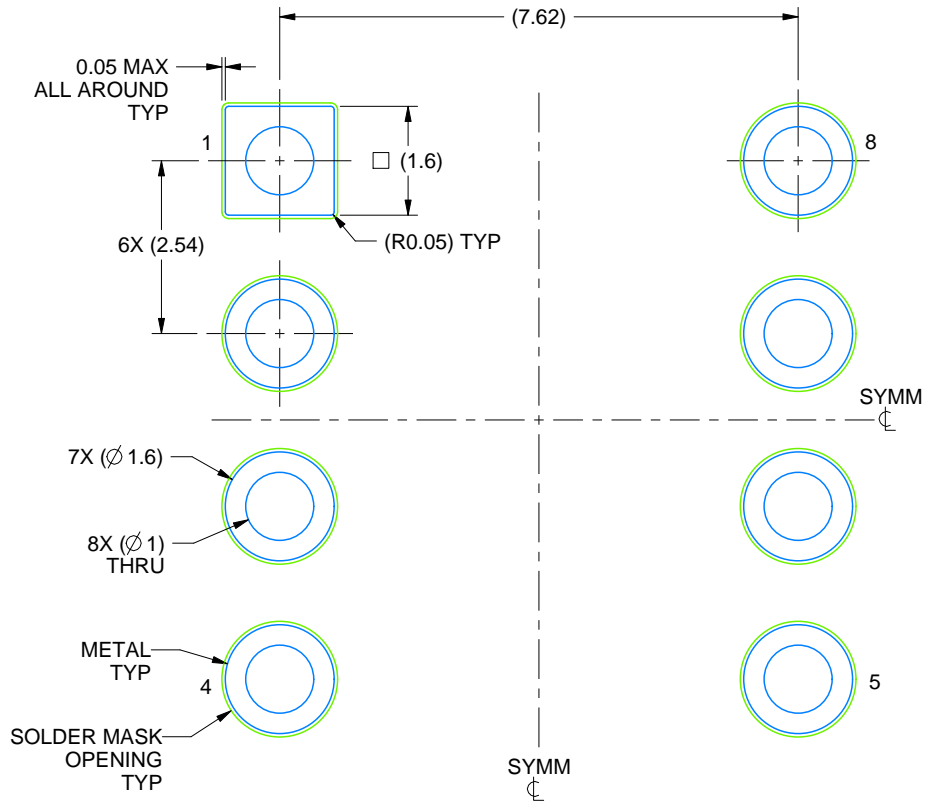

LAND PATTERN EXAMPLE
NON SOLDER MASK DEFINED
SCALE: 9X

4230036/A 09/2023

D0014A



PACKAGE OUTLINE

SOIC - 1.75 mm max height

SMALL OUTLINE INTEGRATED CIRCUIT



NOTES:

1. All linear dimensions are in millimeters. Dimensions in parenthesis are for reference only. Dimensioning and tolerancing per ASME Y14.5M.
2. This drawing is subject to change without notice.
3. This dimension does not include mold flash, protrusions, or gate burrs. Mold flash, protrusions, or gate burrs shall not exceed 0.15 mm, per side.
4. This dimension does not include interlead flash. Interlead flash shall not exceed 0.43 mm, per side.
5. Reference JEDEC registration MS-012, variation AB.

EXAMPLE BOARD LAYOUT

D0014A

SOIC - 1.75 mm max height

SMALL OUTLINE INTEGRATED CIRCUIT



LAND PATTERN EXAMPLE
SCALE:8X



SOLDER MASK DETAILS

4220718/A 09/2016

NOTES: (continued)

- 6. Publication IPC-7351 may have alternate designs.
- 7. Solder mask tolerances between and around signal pads can vary based on board fabrication site.

EXAMPLE STENCIL DESIGN

D0014A

SOIC - 1.75 mm max height

SMALL OUTLINE INTEGRATED CIRCUIT



SOLDER PASTE EXAMPLE
BASED ON 0.125 mm THICK STENCIL
SCALE:8X

4220718/A 09/2016

NOTES: (continued)

8. Laser cutting apertures with trapezoidal walls and rounded corners may offer better paste release. IPC-7525 may have alternate design recommendations.
9. Board assembly site may have different recommendations for stencil design.

W (R-GDFP-F14)

CERAMIC DUAL FLATPACK



- NOTES:
- A. All linear dimensions are in inches (millimeters).
 - B. This drawing is subject to change without notice.
 - C. This package can be hermetically sealed with a ceramic lid using glass frit.
 - D. Index point is provided on cap for terminal identification only.
 - E. Falls within MIL STD 1835 GDFP1-F14

GENERIC PACKAGE VIEW

FK 20

LCCC - 2.03 mm max height

8.89 x 8.89, 1.27 mm pitch

LEADLESS CERAMIC CHIP CARRIER

This image is a representation of the package family, actual package may vary.
Refer to the product data sheet for package details.



4229370VA\

J 14

GENERIC PACKAGE VIEW
CDIP - 5.08 mm max height
CERAMIC DUAL IN LINE PACKAGE



Images above are just a representation of the package family, actual package may vary.
Refer to the product data sheet for package details.

4040083-5/G

J0014A



PACKAGE OUTLINE

CDIP - 5.08 mm max height

CERAMIC DUAL IN LINE PACKAGE



4214771/A 05/2017

NOTES:

1. All controlling linear dimensions are in inches. Dimensions in brackets are in millimeters. Any dimension in brackets or parenthesis are for reference only. Dimensioning and tolerancing per ASME Y14.5M.
2. This drawing is subject to change without notice.
3. This package is hermetically sealed with a ceramic lid using glass frit.
4. Index point is provided on cap for terminal identification only and on press ceramic glass frit seal only.
5. Falls within MIL-STD-1835 and GDIP1-T14.

EXAMPLE BOARD LAYOUT

J0014A

CDIP - 5.08 mm max height

CERAMIC DUAL IN LINE PACKAGE



LAND PATTERN EXAMPLE
NON-SOLDER MASK DEFINED
SCALE: 5X

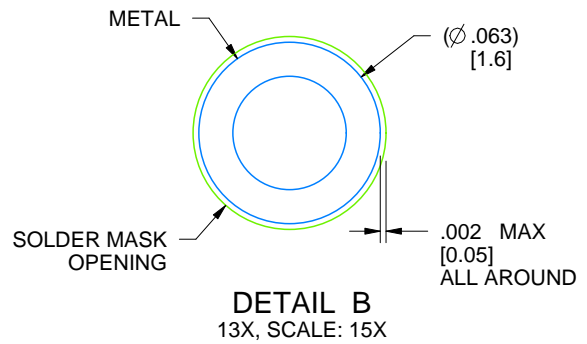

4214771/A 05/2017

EXAMPLE BOARD LAYOUT

D0008A

SOIC - 1.75 mm max height

SMALL OUTLINE INTEGRATED CIRCUIT



LAND PATTERN EXAMPLE
EXPOSED METAL SHOWN
SCALE:8X



SOLDER MASK DETAILS

4214825/C 02/2019

NOTES: (continued)

6. Publication IPC-7351 may have alternate designs.

7. Solder mask tolerances between and around signal pads can vary based on board fabrication site.

EXAMPLE STENCIL DESIGN

D0008A

SOIC - 1.75 mm max height

SMALL OUTLINE INTEGRATED CIRCUIT



SOLDER PASTE EXAMPLE
BASED ON .005 INCH [0.125 MM] THICK STENCIL
SCALE:8X

4214825/C 02/2019

NOTES: (continued)

8. Laser cutting apertures with trapezoidal walls and rounded corners may offer better paste release. IPC-7525 may have alternate design recommendations.
9. Board assembly site may have different recommendations for stencil design.

P (R-PDIP-T8)

PLASTIC DUAL-IN-LINE PACKAGE



- NOTES:
- A. All linear dimensions are in inches (millimeters).
 - B. This drawing is subject to change without notice.
 - C. Falls within JEDEC MS-001 variation BA.

N (R-PDIP-T**)

PLASTIC DUAL-IN-LINE PACKAGE

16 PINS SHOWN



- NOTES:
- A. All linear dimensions are in inches (millimeters).
 - B. This drawing is subject to change without notice.
 - Falls within JEDEC MS-001, except 18 and 20 pin minimum body length (Dim A).
 - The 20 pin end lead shoulder width is a vendor option, either half or full width.

IMPORTANT NOTICE AND DISCLAIMER

TI PROVIDES TECHNICAL AND RELIABILITY DATA (INCLUDING DATA SHEETS), DESIGN RESOURCES (INCLUDING REFERENCE DESIGNS), APPLICATION OR OTHER DESIGN ADVICE, WEB TOOLS, SAFETY INFORMATION, AND OTHER RESOURCES "AS IS" AND WITH ALL FAULTS, AND DISCLAIMS ALL WARRANTIES, EXPRESS AND IMPLIED, INCLUDING WITHOUT LIMITATION ANY IMPLIED WARRANTIES OF MERCHANTABILITY, FITNESS FOR A PARTICULAR PURPOSE OR NON-INFRINGEMENT OF THIRD PARTY INTELLECTUAL PROPERTY RIGHTS.

These resources are intended for skilled developers designing with TI products. You are solely responsible for (1) selecting the appropriate TI products for your application, (2) designing, validating and testing your application, and (3) ensuring your application meets applicable standards, and any other safety, security, regulatory or other requirements.

These resources are subject to change without notice. TI grants you permission to use these resources only for development of an application that uses the TI products described in the resource. Other reproduction and display of these resources is prohibited. No license is granted to any other TI intellectual property right or to any third party intellectual property right. TI disclaims responsibility for, and you will fully indemnify TI and its representatives against, any claims, damages, costs, losses, and liabilities arising out of your use of these resources.

TI's products are provided subject to [TI's Terms of Sale](#) or other applicable terms available either on [ti.com](https://www.ti.com) or provided in conjunction with such TI products. TI's provision of these resources does not expand or otherwise alter TI's applicable warranties or warranty disclaimers for TI products.

TI objects to and rejects any additional or different terms you may have proposed.

Mailing Address: Texas Instruments, Post Office Box 655303, Dallas, Texas 75265

Copyright © 2025, Texas Instruments Incorporated