

TLC0831C, TLC0831I
TLC0832C, TLC0832I

8-BIT ANALOG-TO-DIGITAL CONVERTERS WITH SERIAL CONTROL

SLAS107B – JANUARY 1995 – REVISED APRIL 1996

- **8-Bit Resolution**
- **Easy Microprocessor Interface or Standalone Operation**
- **Operates Ratiometrically or With 5-V Reference**
- **Single Channel or Multiplexed Twin Channels With Single-Ended or Differential Input Options**
- **Input Range 0 to 5 V With Single 5-V Supply**
- **Inputs and Outputs Are Compatible With TTL and MOS**
- **Conversion Time of 32 μ s at $f_{\text{clock}} = 250$ kHz**
- **Designed to Be Interchangeable With National Semiconductor ADC0831 and ADC0832**
- **Total Unadjusted Error . . . ± 1 LSB**

TLC0831 . . . D OR P PACKAGE
(TOP VIEW)

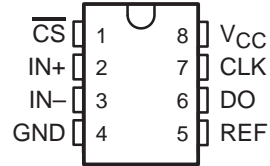

TLC0832 . . . D OR P PACKAGE
(TOP VIEW)

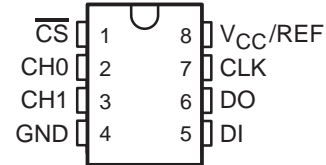

description

These devices are 8-bit successive-approximation analog-to-digital converters. The TLC0831 has single input channels; the TLC0832 has multiplexed twin input channels. The serial output is configured to interface with standard shift registers or microprocessors.

The TLC0832 multiplexer is software configured for single-ended or differential inputs. The differential analog voltage input allows for common-mode rejection or offset of the analog zero input voltage value. In addition, the voltage reference input can be adjusted to allow encoding any smaller analog voltage span to the full 8 bits of resolution.

The operation of the TLC0831 and TLC0832 devices is very similar to the more complex TLC0834 and TLC0838 devices. Ratiometric conversion can be attained by setting the REF input equal to the maximum analog input signal value, which gives the highest possible conversion resolution. Typically, REF is set equal to V_{CC} (done internally on the TLC0832).

The TLC0831C and TLC0832C are characterized for operation from 0°C to 70°C. The TLC0831I and TLC0832I are characterized for operation from -40°C to 85°C.

AVAILABLE OPTIONS

T _A	PACKAGE			
	SMALL OUTLINE (D)		PLASTIC DIP (P)	
0°C to 70°C	TLC0831CD	TLC0832CD	TLC0831CP	TLC0832CP
-40°C to 85°C	TLC0831ID	TLC0832ID	TLC0831IP	TLC0832IP



Please be aware that an important notice concerning availability, standard warranty, and use in critical applications of Texas Instruments semiconductor products and disclaimers thereto appears at the end of this data sheet.

PRODUCTION DATA information is current as of publication date. Products conform to specifications per the terms of Texas Instruments standard warranty. Production processing does not necessarily include testing of all parameters.



POST OFFICE BOX 655303 • DALLAS, TEXAS 75265

Copyright © 1996, Texas Instruments Incorporated

TLC0831C, TLC0831I
 TLC0832C, TLC0832I
8-BIT ANALOG-TO-DIGITAL CONVERTERS WITH SERIAL CONTROL
 SLAS107B – JANUARY 1995 – REVISED APRIL 1996

functional block diagram

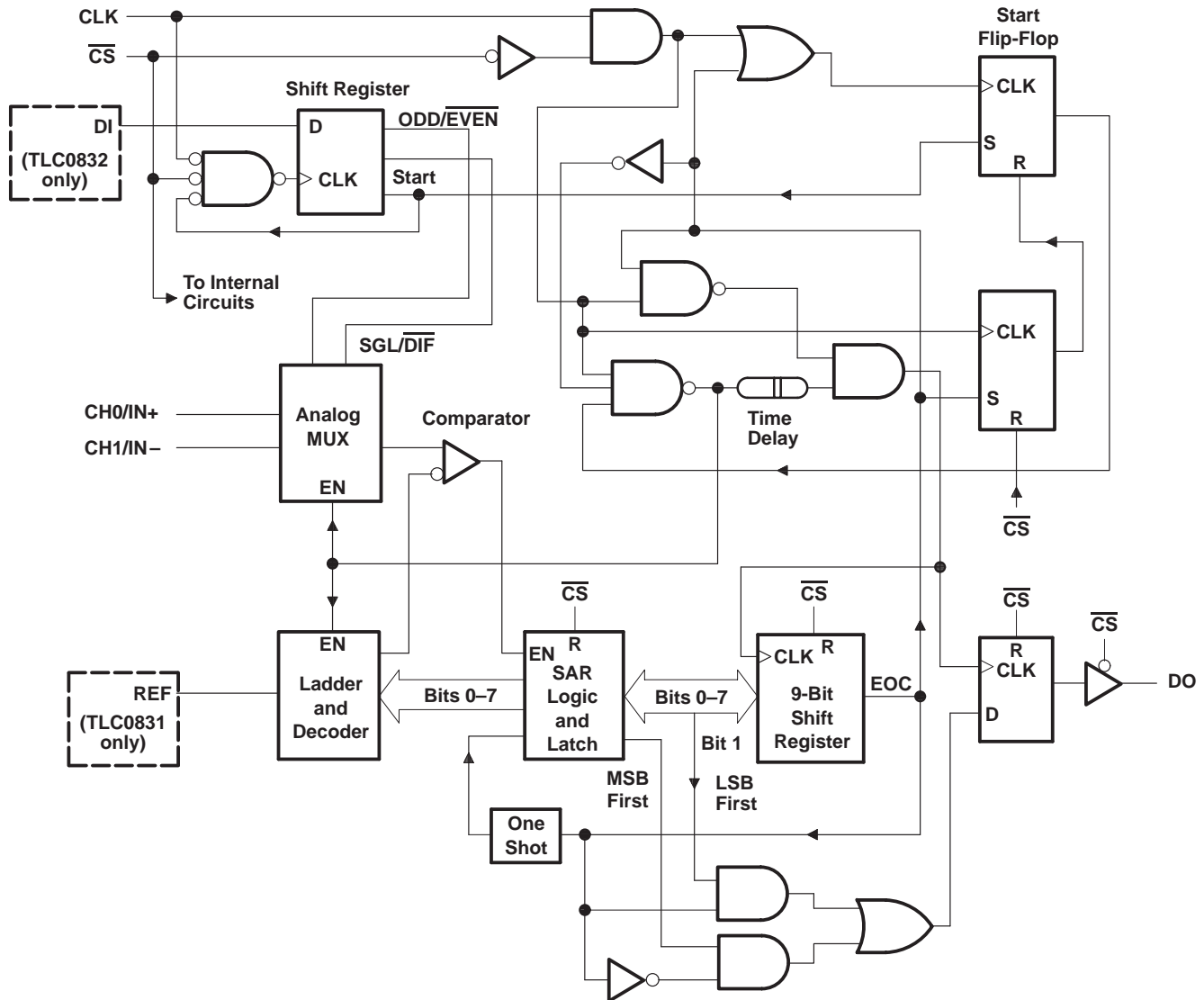

functional description

The TLC0831 and TLC0832 use a sample-data-comparator structure that converts differential analog inputs by a successive-approximation routine. The input voltage to be converted is applied to an input terminal and is compared to ground (single ended), or to an adjacent input (differential). The TLC0832 input terminals can be assigned a positive (+) or negative (–) polarity. The TLC0831 contains only one differential input channel with fixed polarity assignment; therefore it does not require addressing. The signal can be applied differentially, between IN+ and IN–, to the TLC0831 or can be applied to IN+ with IN– grounded as a single ended input. When the signal input applied to the assigned positive terminal is less than the signal on the negative terminal, the converter output is all zeros.

Channel selection and input configuration are under software control using a serial-data link from the controlling processor. A serial-communication format allows more functions to be included in a converter package with no increase in size. In addition, it eliminates the transmission of low-level analog signals by locating the converter at the analog sensor and communicating serially with the controlling processor. This process returns noise-free digital data to the processor.

A conversion is initiated by setting \overline{CS} low, which enables all logic circuits. \overline{CS} must be held low for the complete conversion process. A clock input is then received from the processor. An interval of one clock period is automatically inserted to allow the selected multiplexed channel to settle. DO comes out of the high-impedance state and provides a leading low for one clock period of multiplexer settling time. The SAR comparator compares successive outputs from the resistive ladder with the incoming analog signal. The comparator output indicates whether the analog input is greater than or less than the resistive-ladder output. As the conversion proceeds, conversion data is simultaneously output from DO, with the most significant bit (MSB) first. After eight clock periods, the conversion is complete. When \overline{CS} goes high, all internal registers are cleared. At this time, the output circuits go to the high-impedance state. If another conversion is desired, \overline{CS} must make a high-to-low transition followed by address information.

A TLC0832 input configuration is assigned during the multiplexer-addressing sequence. The multiplexer address shifts into the converter through the data input (DI) line. The multiplexer address selects the analog inputs to be enabled and determines whether the input is single ended or differential. When the input is differential, the polarity of the channel input is assigned. In addition to selecting the differential mode, the polarity may also be selected. Either channel of the channel pair may be designated as the negative or positive input.

On each low-to-high transition of the clock input, the data on DI is clocked into the multiplexer-address shift register. The first logic high on the input is the start bit. A 2-bit assignment word follows the start bit on the TLC0832. On each successive low-to-high transition of the clock input, the start bit and assignment word are shifted through the shift register. When the start bit is shifted into the start location of the multiplexer register, the input channel is selected and conversion starts. The TLC0832 DI terminal to the multiplexer shift register is disabled for the duration of the conversion.

The TLC0832 outputs the least-significant-bit (LSB) first data after the MSB-first data stream. The DI and DO terminals can be tied together and controlled by a bidirectional processor I/O bit received on a single wire. This is possible because DI is only examined during the multiplexer-addressing interval and DO is still in the high-impedance state.

TLC0831C, TLC0831I
 TLC0832C, TLC0832I
8-BIT ANALOG-TO-DIGITAL CONVERTERS WITH SERIAL CONTROL
 SLAS107B – JANUARY 1995 – REVISED APRIL 1996

sequence of operation

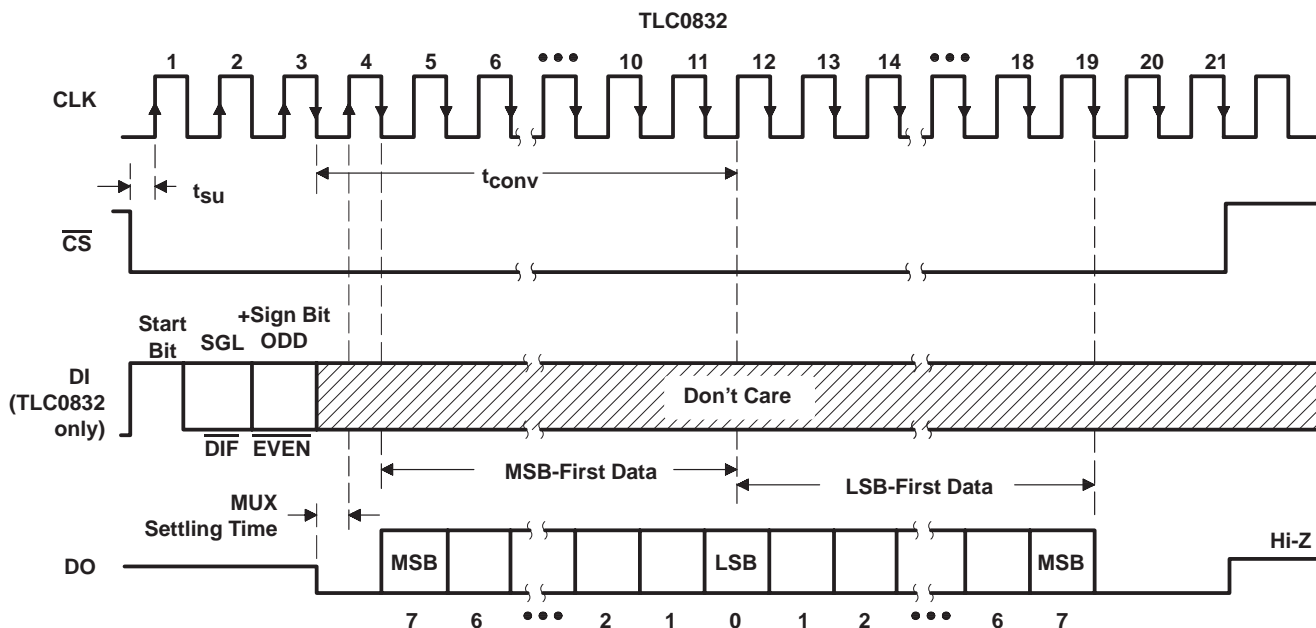
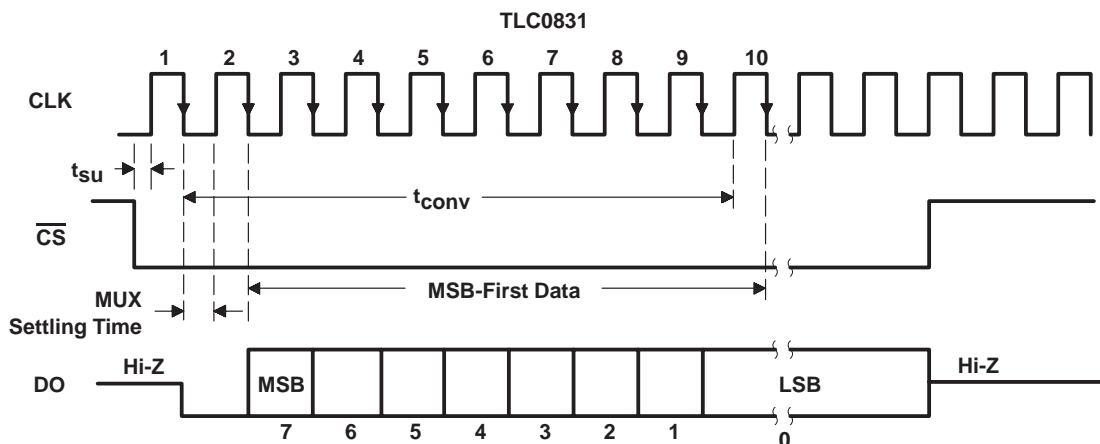

TLC0832 MUX-ADDRESS CONTROL LOGIC TABLE

MUX ADDRESS		CHANNEL NUMBER	
SGL/DIF	ODD/EVEN	CH0	CH1
L	L	+	-
L	H	-	+
H	L	+	-
H	H	-	+

H = high level, L = low level,
 - or + = terminal polarity for the selected input channel



TLC0831C, TLC0831I
TLC0832C, TLC0832I

8-BIT ANALOG-TO-DIGITAL CONVERTERS WITH SERIAL CONTROL

SLAS107B – JANUARY 1995 – REVISED APRIL 1996

electrical characteristics over recommended range of operating free-air temperature, $V_{CC} = 5\text{ V}$, $f_{clock} = 250\text{ kHz}$ (unless otherwise noted)

digital section

PARAMETER	TEST CONDITION†	C SUFFIX			I SUFFIX			UNIT
		MIN	TYP‡	MAX	MIN	TYP‡	MAX	
V _{OH} High-level output voltage	V _{CC} = 4.75 V, I _{OH} = -360 μA	2.8			2.4			V
	V _{CC} = 4.75 V, I _{OH} = -10 μA	4.6			4.5			
V _{OL} Low-level output voltage	V _{CC} = 4.75 V, I _{OL} = 1.6 mA	0.34			0.4			V
I _{IH} High-level input current	V _{IH} = 5 V		0.005	1		0.005	1	μA
I _{IL} Low-level input current	V _{IL} = 0		-0.005	-1		-0.005	-1	μA
I _{OH} High-level output (source) current	V _{OH} = V _O T _A = 25°C	-6.5	-24		-6.5	-24		mA
I _{OL} Low-level output (sink) current	V _{OL} = V _{CC} , T _A = 25°C	8	26		8	26		mA
I _{OZ} High-impedance-state output current (DO)	V _O = 5 V, T _A = 25°C		0.01	3		0.01	3	μA
	V _O = 0, T _A = 25°C		-0.01	-3		-0.01	-3	
C _i Input capacitance			5			5		pF
C _o Output capacitance			5			5		pF

† All parameters are measured under open-loop conditions with zero common-mode input voltage.

‡ All typical values are at V_{CC} = 5 V, T_A = 25°C.

analog and converter section

PARAMETER	TEST CONDITION†	MIN	TYP‡	MAX	UNIT
V _{IC} Common-mode input voltage	See Note 3	-0.05 to V _{CC} +0.05			V
I _{I(stbby)} Standby input current (see Note 4)	On channel	V _I = 5 V		1	μA
	Off channel	V _I = 0		-1	
	On channel	V _I = 0		-1	
	Off channel	V _I = 5 V		1	
r _{i(REF)} Input resistance to REF		1.3	2.4	5.9	kΩ

† All parameters are measured under open-loop conditions with zero common-mode input voltage.

‡ All typical values are at V_{CC} = 5 V, T_A = 25°C.

NOTES: 3. When channel IN- is more positive than channel IN+, the digital output code is 0000 0000. Connected to each analog input are two on-chip diodes that conduct forward current for analog input voltages one diode drop above V_{CC}. Care must be taken during testing at low V_{CC} levels (4.5 V) because high-level analog input voltage (5 V) can, especially at high temperatures, cause the input diode to conduct and cause errors for analog inputs that are near full scale. As long as the analog voltage does not exceed the supply voltage by more than 50 mV, the output code is correct. To achieve an absolute 0- to 5-V input range requires a minimum V_{CC} of 4.95 V for all variations of temperature and load.

4. Standby input currents go in or out of the on or off channels when the A/D converter is not performing conversion and the clock is in a high or low steady-state conditions.

total device

PARAMETER	MIN	TYP‡	MAX	UNIT
I _{CC} Supply current	TLC0831	0.6	1.25	mA
	TLC0832	2.5	4.7	

‡ All typical values are at V_{CC} = 5 V, T_A = 25°C.



8-BIT ANALOG-TO-DIGITAL CONVERTERS WITH SERIAL CONTROL

SLAS107B – JANUARY 1995 – REVISED APRIL 1996

operating characteristics $V_{CC} = V_{ref} = 5\text{ V}$, $f_{clock} = 250\text{ kHz}$, $t_r = t_f = 20\text{ ns}$, $T_A = 25^\circ\text{C}$ (unless otherwise noted)

PARAMETER		TEST CONDITIONS†	MIN	TYP	MAX	UNIT
Supply-voltage variation error		$V_{CC} = 4.75\text{ V to }5.25\text{ V}$		$\pm 1/16$	$\pm 1/4$	LSB
Total unadjusted error (see Note 5)		$V_{ref} = 5\text{ V}$, $T_A = \text{MIN to MAX}$			± 1	LSB
Common-mode error		Differential mode		$\pm 1/16$	$\pm 1/4$	LSB
t_{pd}	Propagation delay time, output data after $\text{CLK}\uparrow$ (see Note 6)	MSB-first data	$C_L = 100\text{ pF}$	650	1500	ns
		LSB-first data		250	600	
t_{dis}	Output disable time, DO after $\overline{\text{CS}}\uparrow$	$C_L = 10\text{ pF}$, $R_L = 10\text{ k}\Omega$		125	250	ns
		$C_L = 100\text{ pF}$, $R_L = 2\text{ k}\Omega$			500	
t_{conv}	Conversion time (multiplexer-addressing time not included)				8	clock periods

† All parameters are measured under open-loop conditions with zero common-mode input voltage. For conditions shown as MIN or MAX, use the appropriate value specified under recommended operating conditions.

- NOTES: 5. Total unadjusted error includes offset, full-scale, linearity, and multiplexer errors.
6. The MSB-first data is output directly from the comparator and, therefore, requires additional delay to allow for comparator response time. LSB-first data applies only to TLC0832.

PARAMETER MEASUREMENT INFORMATION

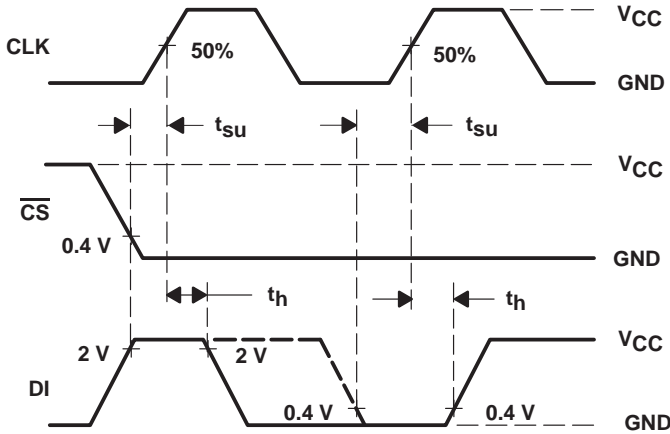

Figure 1. TLC0832 Data-Input Timing

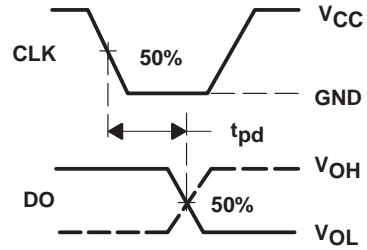
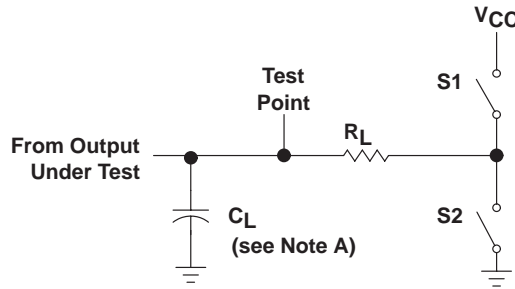
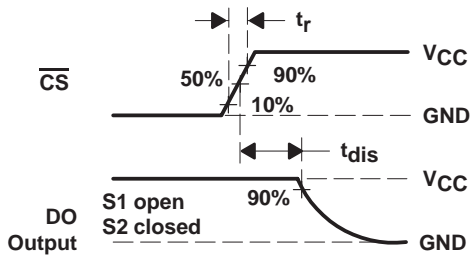

Figure 2. Data-Output Timing



LOAD CIRCUIT



VOLTAGE WAVEFORMS

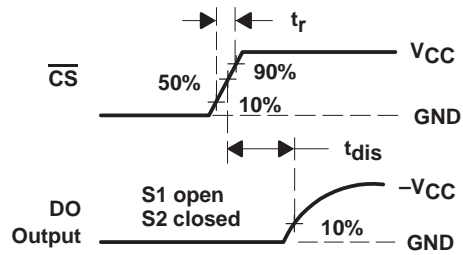

VOLTAGE WAVEFORMS

NOTE A: C_L includes probe and jig capacitance.

Figure 3. Output Disable Time Test Circuit and Voltage Waveforms

TYPICAL CHARACTERISTICS

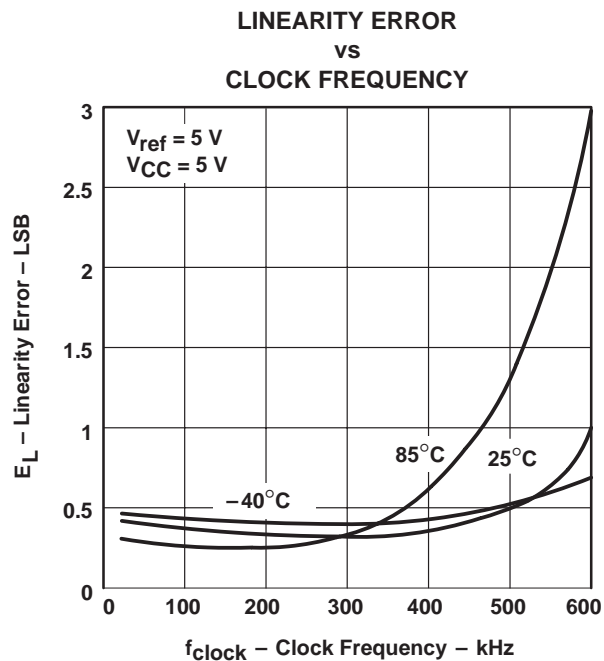
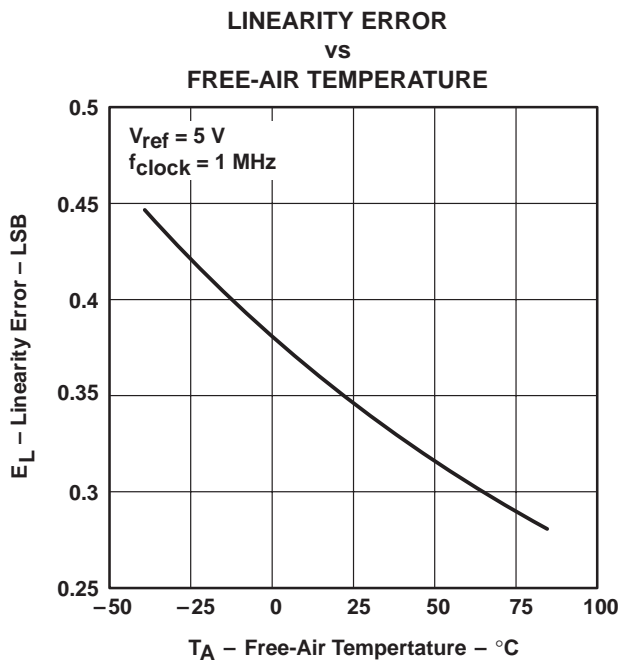
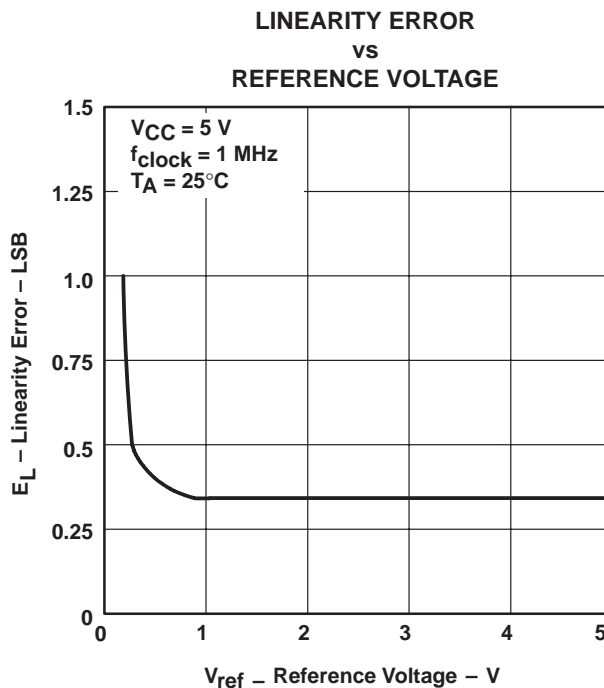
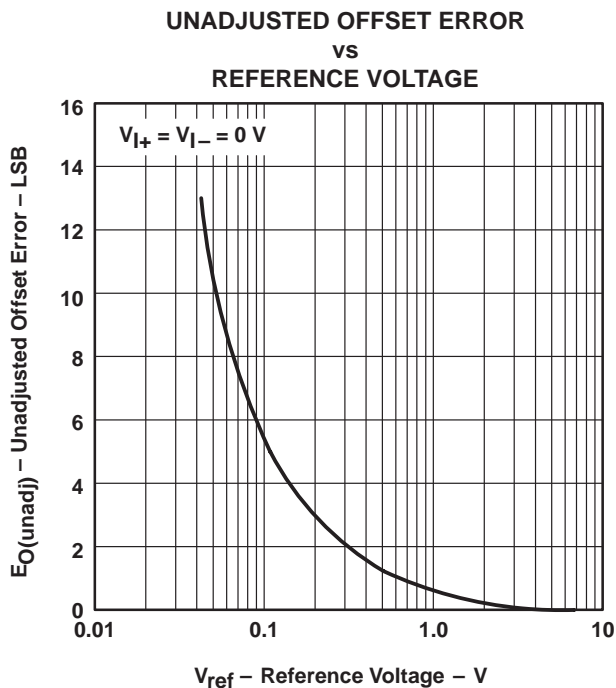

TYPICAL CHARACTERISTICS

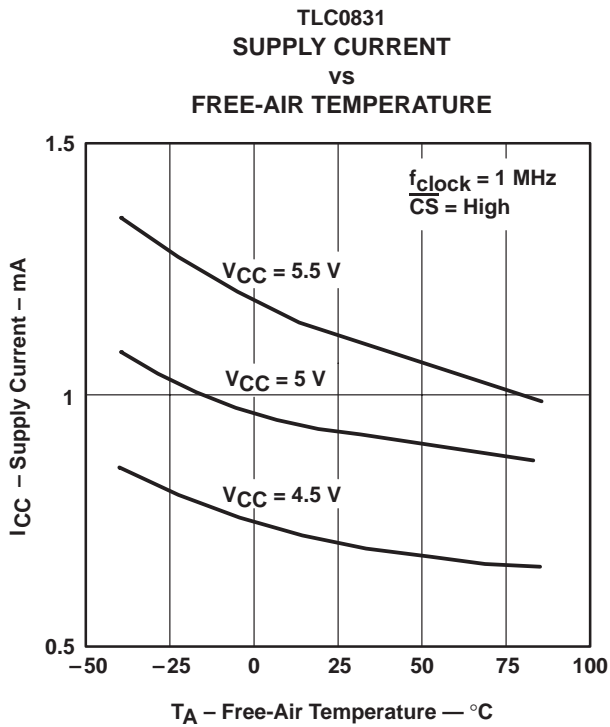

Figure 8

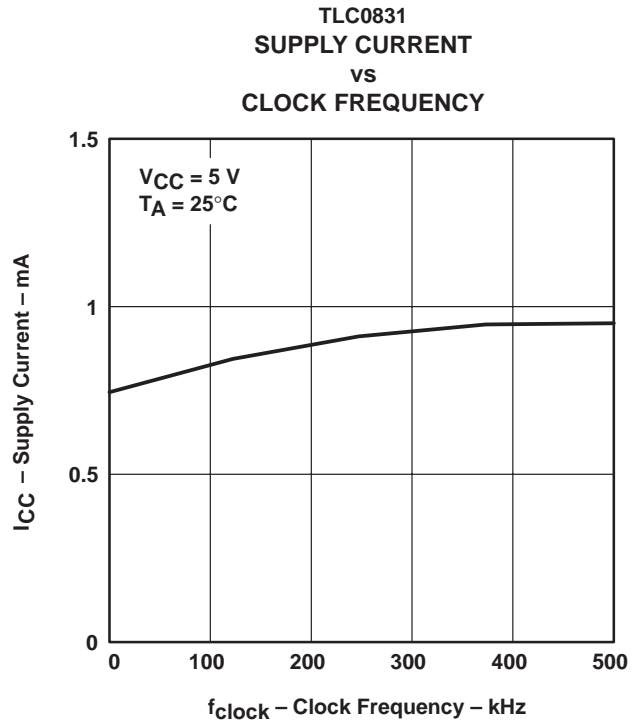

Figure 9

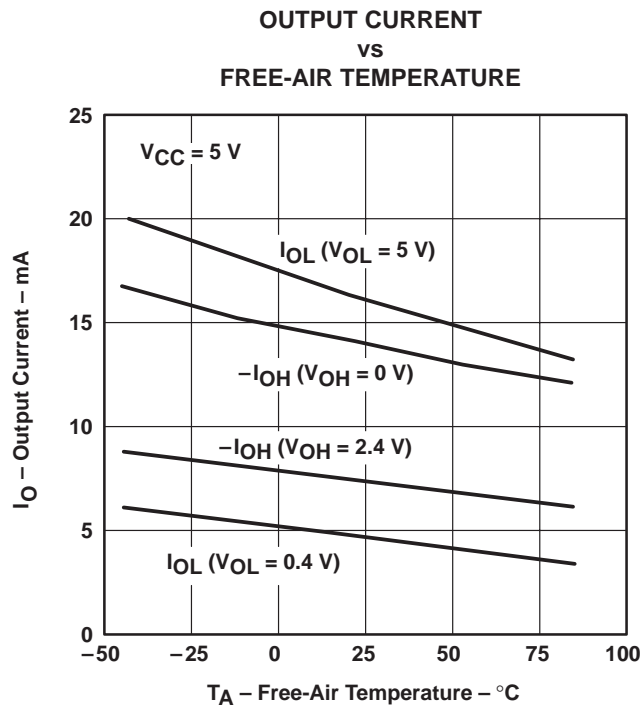

Figure 10

TYPICAL CHARACTERISTICS

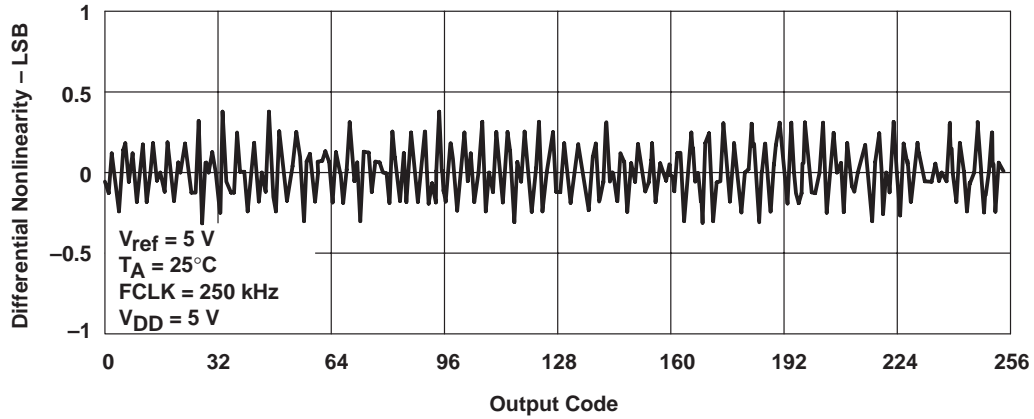

Figure 11. Differential Nonlinearity With Output Code

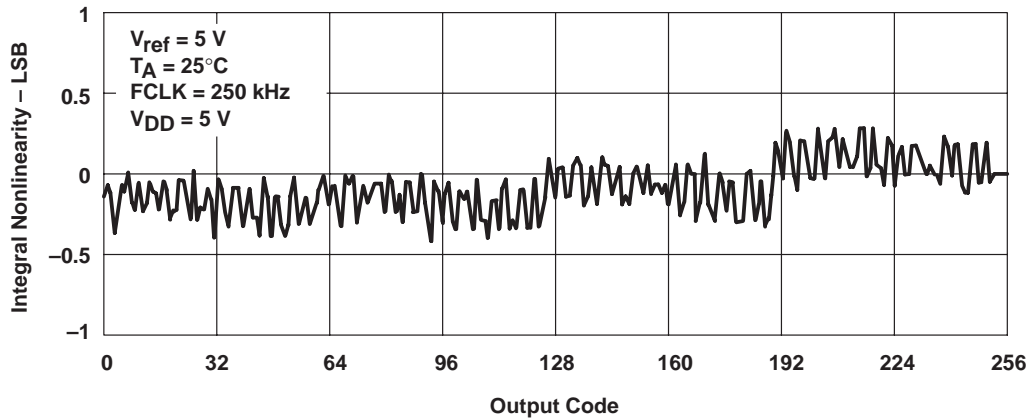

Figure 12. Integral Nonlinearity With Output Code

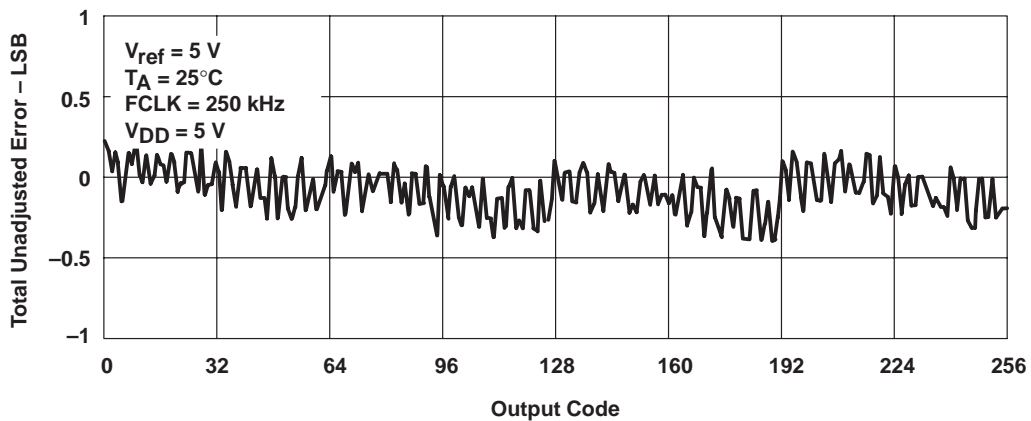

Figure 13. Total Unadjusted Error With Output Code

PACKAGING INFORMATION

Orderable Device	Status (1)	Package Type	Package Drawing	Pins	Package Qty	Eco Plan (2)	Lead finish/ Ball material (6)	MSL Peak Temp (3)	Op Temp (°C)	Device Marking (4/5)	Samples
TLC0831CD	ACTIVE	SOIC	D	8	75	RoHS & Green	NIPDAU	Level-1-260C-UNLIM	-40 to 85	C0831C	Samples
TLC0831CDR	ACTIVE	SOIC	D	8	2500	RoHS & Green	NIPDAU	Level-1-260C-UNLIM		C0831C	Samples
TLC0831CP	ACTIVE	PDIP	P	8	50	RoHS & Green	NIPDAU	N / A for Pkg Type		TLC0831CP	Samples
TLC0831CPE4	ACTIVE	PDIP	P	8	50	RoHS & Green	NIPDAU	N / A for Pkg Type		TLC0831CP	Samples
TLC0831ID	ACTIVE	SOIC	D	8	75	RoHS & Green	NIPDAU	Level-1-260C-UNLIM			Samples
TLC0831IDR	ACTIVE	SOIC	D	8	2500	RoHS & Green	NIPDAU	Level-1-260C-UNLIM			Samples
TLC0831IP	ACTIVE	PDIP	P	8	50	RoHS & Green	NIPDAU	N / A for Pkg Type		TLC0831IP	Samples
TLC0832CD	ACTIVE	SOIC	D	8	75	RoHS & Green	NIPDAU	Level-1-260C-UNLIM	-40 to 85	C0832C	Samples
TLC0832CDR	ACTIVE	SOIC	D	8	2500	RoHS & Green	NIPDAU	Level-1-260C-UNLIM		C0832C	Samples
TLC0832CP	ACTIVE	PDIP	P	8	50	RoHS & Green	NIPDAU	N / A for Pkg Type		TLC0832CP	Samples
TLC0832ID	ACTIVE	SOIC	D	8	75	RoHS & Green	NIPDAU	Level-1-260C-UNLIM		C0832I	Samples
TLC0832IDR	ACTIVE	SOIC	D	8	2500	RoHS & Green	NIPDAU	Level-1-260C-UNLIM		C0832I	Samples
TLC0832IP	ACTIVE	PDIP	P	8	50	RoHS & Green	NIPDAU	N / A for Pkg Type		TLC0832IP	Samples
TLC0832IPE4	ACTIVE	PDIP	P	8	50	RoHS & Green	NIPDAU	N / A for Pkg Type		TLC0832IP	Samples

(1) The marketing status values are defined as follows:

ACTIVE: Product device recommended for new designs.

LIFEBUY: TI has announced that the device will be discontinued, and a lifetime-buy period is in effect.

NRND: Not recommended for new designs. Device is in production to support existing customers, but TI does not recommend using this part in a new design.

PREVIEW: Device has been announced but is not in production. Samples may or may not be available.

OBSELETE: TI has discontinued the production of the device.

(2) **RoHS:** TI defines "RoHS" to mean semiconductor products that are compliant with the current EU RoHS requirements for all 10 RoHS substances, including the requirement that RoHS substance do not exceed 0.1% by weight in homogeneous materials. Where designed to be soldered at high temperatures, "RoHS" products are suitable for use in specified lead-free processes. TI may reference these types of products as "Pb-Free".

RoHS Exempt: TI defines "RoHS Exempt" to mean products that contain lead but are compliant with EU RoHS pursuant to a specific EU RoHS exemption.

Green: TI defines "Green" to mean the content of Chlorine (Cl) and Bromine (Br) based flame retardants meet JS709B low halogen requirements of ≤ 1000 ppm threshold. Antimony trioxide based flame retardants must also meet the ≤ 1000 ppm threshold requirement.

(3) MSL, Peak Temp. - The Moisture Sensitivity Level rating according to the JEDEC industry standard classifications, and peak solder temperature.

(4) There may be additional marking, which relates to the logo, the lot trace code information, or the environmental category on the device.

(5) Multiple Device Markings will be inside parentheses. Only one Device Marking contained in parentheses and separated by a "~" will appear on a device. If a line is indented then it is a continuation of the previous line and the two combined represent the entire Device Marking for that device.

(6) Lead finish/Ball material - Orderable Devices may have multiple material finish options. Finish options are separated by a vertical ruled line. Lead finish/Ball material values may wrap to two lines if the finish value exceeds the maximum column width.

Important Information and Disclaimer: The information provided on this page represents TI's knowledge and belief as of the date that it is provided. TI bases its knowledge and belief on information provided by third parties, and makes no representation or warranty as to the accuracy of such information. Efforts are underway to better integrate information from third parties. TI has taken and continues to take reasonable steps to provide representative and accurate information but may not have conducted destructive testing or chemical analysis on incoming materials and chemicals. TI and TI suppliers consider certain information to be proprietary, and thus CAS numbers and other limited information may not be available for release.

In no event shall TI's liability arising out of such information exceed the total purchase price of the TI part(s) at issue in this document sold by TI to Customer on an annual basis.

TAPE AND REEL INFORMATION

QUADRANT ASSIGNMENTS FOR PIN 1 ORIENTATION IN TAPE



*All dimensions are nominal

Device	Package Type	Package Drawing	Pins	SPQ	Reel Diameter (mm)	Reel Width W1 (mm)	A0 (mm)	B0 (mm)	K0 (mm)	P1 (mm)	W (mm)	Pin1 Quadrant
TLC0831CDR	SOIC	D	8	2500	330.0	12.4	6.4	5.2	2.1	8.0	12.0	Q1
TLC0831IDR	SOIC	D	8	2500	330.0	12.4	6.4	5.2	2.1	8.0	12.0	Q1
TLC0832CDR	SOIC	D	8	2500	330.0	12.4	6.4	5.2	2.1	8.0	12.0	Q1
TLC0832IDR	SOIC	D	8	2500	330.0	12.4	6.4	5.2	2.1	8.0	12.0	Q1

TAPE AND REEL BOX DIMENSIONS

*All dimensions are nominal

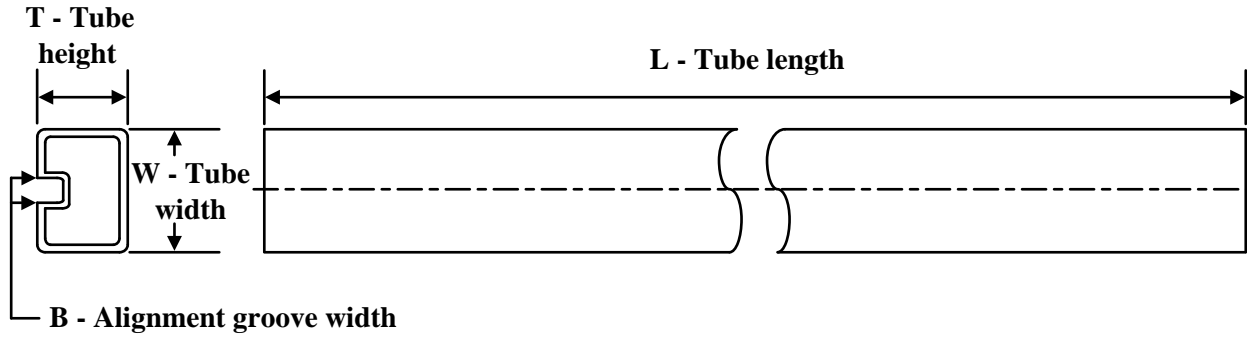
Device	Package Type	Package Drawing	Pins	SPQ	Length (mm)	Width (mm)	Height (mm)
TLC0831CDR	SOIC	D	8	2500	350.0	350.0	43.0
TLC0831IDR	SOIC	D	8	2500	350.0	350.0	43.0
TLC0832CDR	SOIC	D	8	2500	350.0	350.0	43.0
TLC0832IDR	SOIC	D	8	2500	350.0	350.0	43.0

TUBE

*All dimensions are nominal

Device	Package Name	Package Type	Pins	SPQ	L (mm)	W (mm)	T (μm)	B (mm)
TLC0831CD	D	SOIC	8	75	505.46	6.76	3810	4
TLC0831CP	P	PDIP	8	50	506	13.97	11230	4.32
TLC0831CPE4	P	PDIP	8	50	506	13.97	11230	4.32
TLC0831ID	D	SOIC	8	75	505.46	6.76	3810	4
TLC0831IP	P	PDIP	8	50	506	13.97	11230	4.32
TLC0832CD	D	SOIC	8	75	505.46	6.76	3810	4
TLC0832CP	P	PDIP	8	50	506	13.97	11230	4.32
TLC0832ID	D	SOIC	8	75	505.46	6.76	3810	4
TLC0832IP	P	PDIP	8	50	506	13.97	11230	4.32
TLC0832IPE4	P	PDIP	8	50	506	13.97	11230	4.32



D0008A

PACKAGE OUTLINE

SOIC - 1.75 mm max height

SMALL OUTLINE INTEGRATED CIRCUIT



4214825/C 02/2019

NOTES:

- Linear dimensions are in inches [millimeters]. Dimensions in parenthesis are for reference only. Controlling dimensions are in inches. Dimensioning and tolerancing per ASME Y14.5M.
- This drawing is subject to change without notice.
- This dimension does not include mold flash, protrusions, or gate burrs. Mold flash, protrusions, or gate burrs shall not exceed .006 [0.15] per side.
- This dimension does not include interlead flash.
- Reference JEDEC registration MS-012, variation AA.

EXAMPLE BOARD LAYOUT

D0008A

SOIC - 1.75 mm max height

SMALL OUTLINE INTEGRATED CIRCUIT



LAND PATTERN EXAMPLE
 EXPOSED METAL SHOWN
 SCALE:8X



SOLDER MASK DETAILS

4214825/C 02/2019

NOTES: (continued)

- 6. Publication IPC-7351 may have alternate designs.
- 7. Solder mask tolerances between and around signal pads can vary based on board fabrication site.

EXAMPLE STENCIL DESIGN

D0008A

SOIC - 1.75 mm max height

SMALL OUTLINE INTEGRATED CIRCUIT



SOLDER PASTE EXAMPLE
BASED ON .005 INCH [0.125 MM] THICK STENCIL
SCALE:8X

4214825/C 02/2019

NOTES: (continued)

8. Laser cutting apertures with trapezoidal walls and rounded corners may offer better paste release. IPC-7525 may have alternate design recommendations.
9. Board assembly site may have different recommendations for stencil design.

P (R-PDIP-T8)

PLASTIC DUAL-IN-LINE PACKAGE

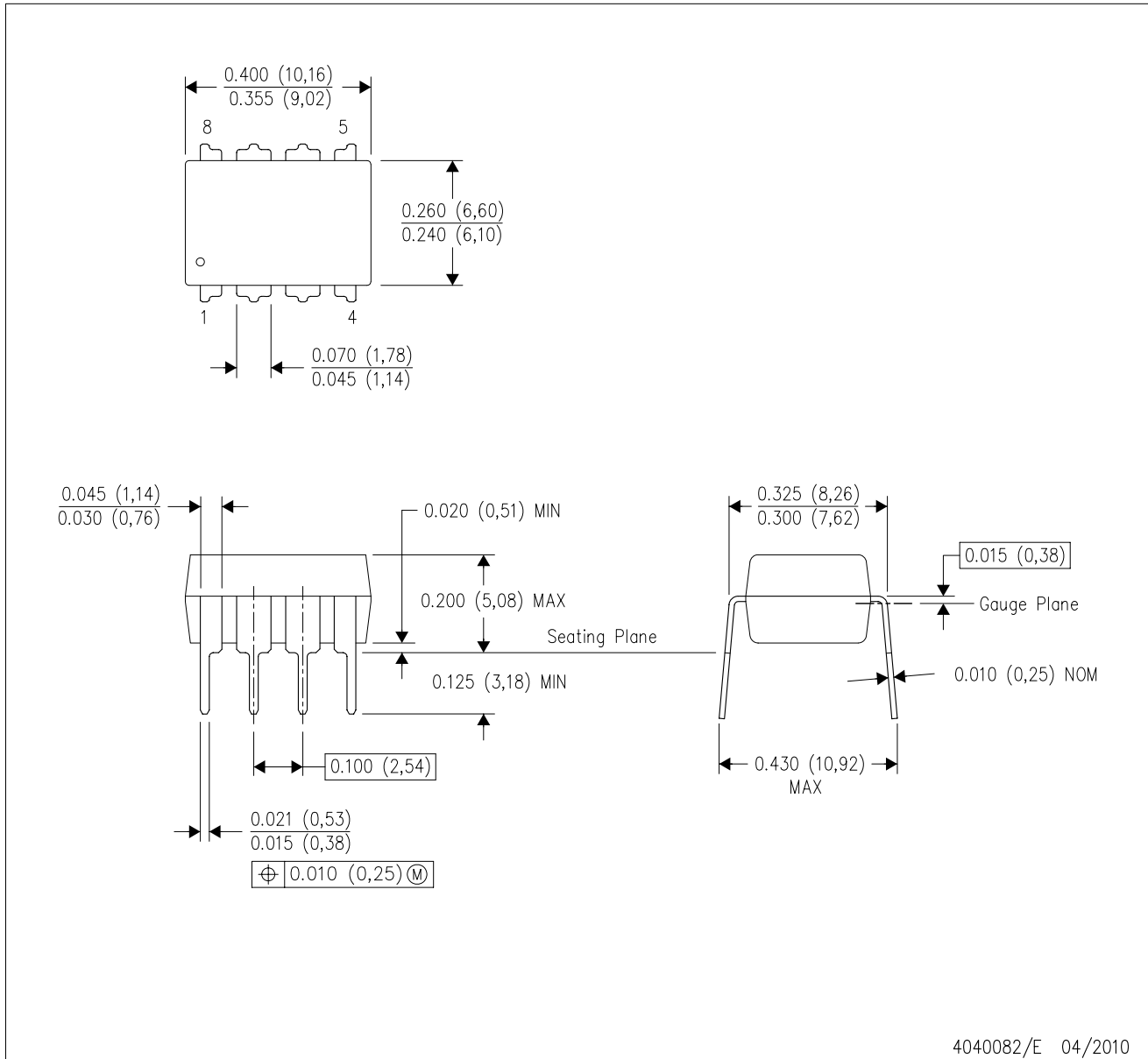

4040082/E 04/2010

IMPORTANT NOTICE AND DISCLAIMER

TI PROVIDES TECHNICAL AND RELIABILITY DATA (INCLUDING DATA SHEETS), DESIGN RESOURCES (INCLUDING REFERENCE DESIGNS), APPLICATION OR OTHER DESIGN ADVICE, WEB TOOLS, SAFETY INFORMATION, AND OTHER RESOURCES "AS IS" AND WITH ALL FAULTS, AND DISCLAIMS ALL WARRANTIES, EXPRESS AND IMPLIED, INCLUDING WITHOUT LIMITATION ANY IMPLIED WARRANTIES OF MERCHANTABILITY, FITNESS FOR A PARTICULAR PURPOSE OR NON-INFRINGEMENT OF THIRD PARTY INTELLECTUAL PROPERTY RIGHTS.

These resources are intended for skilled developers designing with TI products. You are solely responsible for (1) selecting the appropriate TI products for your application, (2) designing, validating and testing your application, and (3) ensuring your application meets applicable standards, and any other safety, security, regulatory or other requirements.

These resources are subject to change without notice. TI grants you permission to use these resources only for development of an application that uses the TI products described in the resource. Other reproduction and display of these resources is prohibited. No license is granted to any other TI intellectual property right or to any third party intellectual property right. TI disclaims responsibility for, and you will fully indemnify TI and its representatives against, any claims, damages, costs, losses, and liabilities arising out of your use of these resources.

TI's products are provided subject to [TI's Terms of Sale](#) or other applicable terms available either on [ti.com](https://www.ti.com) or provided in conjunction with such TI products. TI's provision of these resources does not expand or otherwise alter TI's applicable warranties or warranty disclaimers for TI products.

TI objects to and rejects any additional or different terms you may have proposed.

Mailing Address: Texas Instruments, Post Office Box 655303, Dallas, Texas 75265
Copyright © 2023, Texas Instruments Incorporated