

SN74LVC2G53 単極双投 (SPDT) アナログ・スイッチ

2:1 アナログ・マルチプレクサ/デマルチプレクサ

1 特長

- テキサス・インスツルメンツの NanoFree™ パッケージで供給
- 1.65V ~ 5.5V の V_{CC} で動作
- 高いオン/オフ出力電圧比
- 高度な線形性
- 高速、標準値 0.5ns ($V_{CC} = 3V$, $C_L = 50pF$)
- 低いオン抵抗、標準値 6.5 Ω ($V_{CC} = 4.5V$)
- JESD 78, Class II 準拠で100mA超のラッチアップ性能

2 アプリケーション

- ワイヤレス・デバイス
- オーディオおよびビデオ信号のルーティング
- ポータブル・コンピュータ
- ウェアラブル・デバイス
- 信号ゲーティング、チョッピング、変調または復調(モデム)
- アナログ/デジタルおよびデジタル/アナログ変換システム用の信号多重化

3 概要

この単一の 2:1 アナログ・マルチプレクサ/デマルチプレクサは、1.65V ~ 5.5V の V_{CC} で動作するように設計されています。

SN74LVC2G53 デバイスは、アナログとデジタルの両方の信号を扱うことができます。このデバイスは、最大 5.5V (ピーク) までの振幅の信号を、どちらの方向にも転送できます。

NanoFree パッケージ技術は IC パッケージの概念における主要なブレイクスルーであり、ダイをパッケージとして使用します。

信号ゲーティング、チョッピング、変調または復調(モデム)、およびアナログ/デジタルやデジタル/アナログ変換システム用の信号多重化などのアプリケーションに使用できます。

製品情報⁽¹⁾

型番	パッケージ	本体サイズ(公称)
SN74LVC2G53DCT	SM8 (8)	2.95mmx2.80mm
SN74LVC2G53DCU	VSSOP (8)	2.30mmx2.00mm
SN74LVC2G53YZP	DSBGA (8)	1.91mmx0.91mm

(1) 利用可能なすべてのパッケージについては、このデータシートの末尾にある注文情報を参照してください。

ロジック図

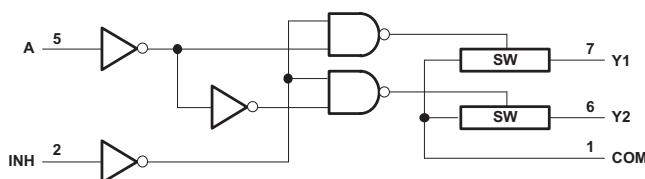

NOTE: 単純化のため、図 1 から図 4 まで、および図 6 から図 10 までに示すテスト条件はデマルチプレクサ構成のものです。信号は COM から Y1 (Y2) へ、または Y1 (Y2) から COM へ渡すことができます。

論理図、各スイッチ (SW)

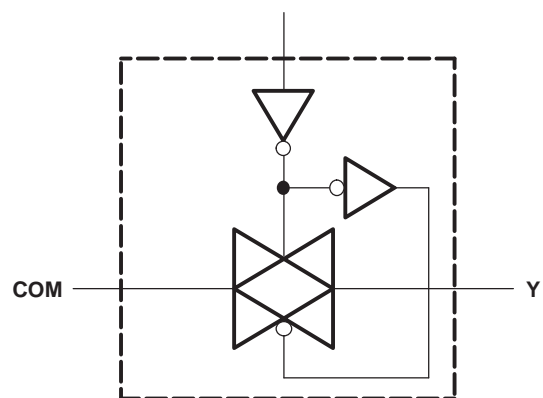

目次

1	特長	1	8.2	Functional Block Diagram	15
2	アプリケーション	1	8.3	Feature Description	15
3	概要	1	8.4	Device Functional Modes	15
4	改訂履歴	2	9	Application and Implementation	16
5	Pin Configuration and Functions	3	9.1	Application Information	16
6	Specifications	4	9.2	Typical Application	16
6.1	Absolute Maximum Ratings	4	10	Power Supply Recommendations	17
6.2	ESD Ratings	4	11	Layout	18
6.3	Recommended Operating Conditions	4	11.1	Layout Guidelines	18
6.4	Thermal Information	5	11.2	Layout Example	18
6.5	Electrical Characteristics	5	12	デバイスおよびドキュメントのサポート	19
6.6	Switching Characteristics	6	12.1	ドキュメントのサポート	19
6.7	Analog Switch Characteristics	6	12.2	ドキュメントの更新通知を受け取る方法	19
6.8	Operating Characteristics	7	12.3	コミュニティ・リソース	19
6.9	Typical Characteristics	8	12.4	商標	19
7	Parameter Measurement Information	9	12.5	静電気放電に関する注意事項	19
8	Detailed Description	15	12.6	Glossary	19
8.1	Overview	15	13	メカニカル、パッケージ、および注文情報	19

4 改訂履歴

資料番号末尾の英字は改訂を表しています。その改訂履歴は英語版に準じています。

Revision P (October 2016) から Revision Q に変更	Page
• Changed the <i>Thermal Information</i> table	5

Revision O (December 2015) から Revision P に変更	Page
• Added DSBGA package in <i>Pin Functions</i> table	3
• 追加「ドキュメントの更新通知を受け取る方法」セクション	19

Revision N (January 2014) から Revision O に変更	Page
• 「アプリケーション」セクション、「製品情報」表、「ESD 定格」表、「熱に関する情報」表、「機能説明」セクション、「デバイスの機能モード」セクション、「アプリケーションと実装」セクション、「電源に関する推奨事項」セクション、「レイアウト」セクション、「デバイスおよびドキュメントのサポート」セクション、「メカニカル、パッケージ、および注文情報」セクションを追加	1
• Moved T_{sig} to <i>Absolute Maximum Ratings</i> table	4

5 Pin Configuration and Functions

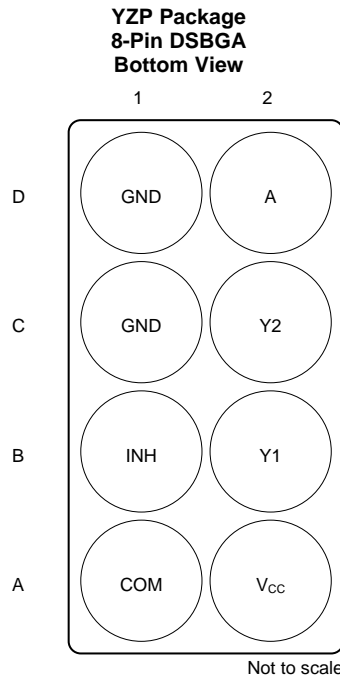
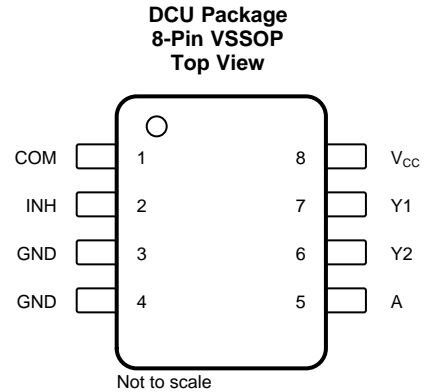
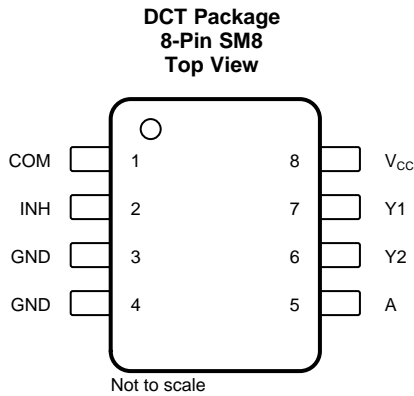

See [メカニカル、パッケージ、および注文情報](#) for dimensions.

Pin Functions

NAME	PIN		I/O	DESCRIPTION
	SM8, VSSOP	DSBGA		
A	5	D2	I	Controls the switch
COM	1	A1	I/O	Bidirectional signal to be switched
GND	3	C1	—	Ground pin
GND	4	D1	—	Ground pin
INH	2	B1	I	Enables or disables the switch
V _{CC}	8	A2	—	Power pin
Y2	6	C2	I/O	Bidirectional signal to be switched
Y1	7	B2	I/O	Bidirectional signal to be switched

6 Specifications

6.1 Absolute Maximum Ratings

 over operating free-air temperature range (unless otherwise noted)⁽¹⁾

		MIN	MAX	UNIT
V _{CC}	Supply voltage ⁽²⁾	-0.5	6.5	V
V _I	Input voltage ⁽²⁾⁽³⁾	-0.5	6.5	V
V _{I/O}	Switch I/O voltage ⁽²⁾⁽³⁾⁽⁴⁾	-0.5	V _{CC} + 0.5	V
I _{IK}	Control input clamp current	V _I < 0	-50	mA
I _{I/O}	I/O port diode current	V _{I/O} < 0 or V _{I/O} > V _{CC}	±50	mA
I _T	ON-state switch current	V _{I/O} = 0 to V _{CC}	±50	mA
	Continuous current through V _{CC} or GND		±100	mA
T _J	Junction temperature		150	°C
T _{stg}	Storage temperature	-65	150	°C

(1) Stresses beyond those listed under *Absolute Maximum Ratings* may cause permanent damage to the device. These are stress ratings only, and functional operation of the device at these or any other conditions beyond those indicated under *Recommended Operating Conditions* is not implied. Exposure to absolute-maximum-rated conditions for extended periods may affect device reliability.

(2) All voltages are with respect to ground, unless otherwise specified.

(3) The input and output voltage ratings may be exceeded if the input and output clamp-current ratings are observed.

(4) This value is limited to 5.5 V maximum.

6.2 ESD Ratings

		VALUE	UNIT
V _(ESD)	Electrostatic discharge	Human body model (HBM), per ANSI/ESDA/JEDEC JS-001 ⁽¹⁾	±2000
		Charged-device model (CDM), per JEDEC specification JESD22-C101 ⁽²⁾	±1000

(1) JEDEC document JEP155 states that 500-V HBM allows safe manufacturing with a standard ESD control process.

(2) JEDEC document JEP157 states that 250-V CDM allows safe manufacturing with a standard ESD control process.

6.3 Recommended Operating Conditions

 See note⁽¹⁾.

		MIN	MAX	UNIT
V _{CC}	Supply voltage	1.65	5.5	V
V _{I/O}	I/O port voltage	0	V _{CC}	V
V _{IH}	High-level input voltage, control input	V _{CC} = 1.65 V to 1.95 V	V _{CC} × 0.65	V
		V _{CC} = 2.3 V to 2.7 V	V _{CC} × 0.7	
		V _{CC} = 3 V to 3.6 V	V _{CC} × 0.7	
		V _{CC} = 4.5 V to 5.5 V	V _{CC} × 0.7	
V _{IL}	Low-level input voltage, control input	V _{CC} = 1.65 V to 1.95 V	V _{CC} × 0.35	V
		V _{CC} = 2.3 V to 2.7 V	V _{CC} × 0.3	
		V _{CC} = 3 V to 3.6 V	V _{CC} × 0.3	
		V _{CC} = 4.5 V to 5.5 V	V _{CC} × 0.3	
V _I	Control input voltage	0	5.5	V
Δt/Δv	Input transition rise and fall time	V _{CC} = 1.65 V to 1.95 V	20	ns/V
		V _{CC} = 2.3 V to 2.7 V	20	
		V _{CC} = 3 V to 3.6 V	10	
		V _{CC} = 4.5 V to 5.5 V	10	
T _A	Operating free-air temperature	-40	85	°C

(1) All unused inputs of the device must be held at V_{CC} or GND to ensure proper device operation. See [Implications of Slow or Floating CMOS Inputs](#), SCBA004.

6.4 Thermal Information

THERMAL METRIC ⁽¹⁾		SN74LVC2G53			UNIT
		DCT (SM8)	DCU (VSSOP)	YZP (DSBGA)	
		8 PINS	8 PINS	8 PINS	
$R_{\theta JA}$	Junction-to-ambient thermal resistance ⁽²⁾	185.9	288.9	98.3	°C/W
$R_{\theta JC(top)}$	Junction-to-case (top) thermal resistance	116.3	99.6	1.1	°C/W
$R_{\theta JB}$	Junction-to-board thermal resistance	98.4	207.3	27.6	°C/W
Ψ_{JT}	Junction-to-top characterization parameter	41.6	22.4	0.6	°C/W
Ψ_{JB}	Junction-to-board characterization parameter	97.3	205.7	27.4	°C/W

(1) For more information about traditional and new thermal metrics, see the [Semiconductor and IC Package Thermal Metrics](#) application report.

(2) The package thermal impedance is calculated in accordance with JESD 51-7.

6.5 Electrical Characteristics

over recommended operating free-air temperature range (unless otherwise noted)

PARAMETER		TEST CONDITIONS	V_{CC}	MIN	TYP ⁽¹⁾	MAX	UNIT
r_{on}	ON-state switch resistance	$V_I = V_{CC}$ or GND, $V_{INH} = V_{IL}$ (see Figure 2 and Figure 1)	$I_S = 4$ mA	1.65 V	13	30	Ω
			$I_S = 8$ mA	2.3 V	10	20	
			$I_S = 24$ mA	3 V	8.5	17	
			$I_S = 32$ mA	4.5 V	6.5	13	
$r_{on(p)}$	Peak ON-state resistance	$V_I = V_{CC}$ to GND, $V_{INH} = V_{IL}$ (see Figure 2 and Figure 1)	$I_S = 4$ mA	1.65 V	86.5	120	Ω
			$I_S = 8$ mA	2.3 V	23	30	
			$I_S = 24$ mA	3 V	13	20	
			$I_S = 32$ mA	4.5 V	8	15	
Δr_{on}	Difference of ON-state resistance between switches	$V_I = V_{CC}$ to GND, $V_C = V_{IH}$ (see Figure 2 and Figure 1)	$I_S = 4$ mA	1.65 V		7	Ω
			$I_S = 8$ mA	2.3 V		5	
			$I_S = 24$ mA	3 V		3	
			$I_S = 32$ mA	4.5 V		2	
$I_{S(off)}$	OFF-state switch leakage current	$V_I = V_{CC}$ and $V_O =$ GND or $V_I =$ GND and $V_O = V_{CC}$, $V_{INH} = V_{IH}$ (see Figure 3)	5.5 V			± 1 $\pm 0.1^{(1)}$	μA
$I_{S(on)}$	ON-state switch leakage current	$V_I = V_{CC}$ or GND, $V_{INH} = V_{IL}$, $V_O =$ Open (see Figure 4)	5.5 V			± 1 $\pm 0.1^{(1)}$	μA
I_I	Control input current	$V_C = V_{CC}$ or GND	5.5 V			± 1 $\pm 0.1^{(1)}$	μA
I_{CC}	Supply current	$V_C = V_{CC}$ or GND	5.5 V			1	μA
ΔI_{CC}	Supply-current change	$V_C = V_{CC} - 0.6$ V	5.5 V			500	μA
C_{ic}	Control input capacitance		5 V		3.5		pF
$C_{io(off)}$	Switch input/output capacitance	Y	5 V		6.5		pF
		COM			10		
$C_{io(on)}$	Switch input/output capacitance		5 V		19.5		pF

(1) $T_A = 25^\circ C$

6.6 Switching Characteristics

 over recommended operating free-air temperature range (unless otherwise noted) (see [Figure 5](#))

PARAMETER	FROM (INPUT)	TO (OUTPUT)	V _{CC}	MIN	MAX	UNIT
t _{pd} ⁽¹⁾	COM or Y	Y or COM	V _{CC} = 1.8 V ± 0.15 V		2	ns
			V _{CC} = 2.5 V ± 0.2 V		1.2	
			V _{CC} = 3.3 V ± 0.3 V		0.8	
			V _{CC} = 5 V ± 0.5 V		0.6	
t _{en} ⁽²⁾	INH	COM or Y	V _{CC} = 1.8 V ± 0.15 V	3.3	9	ns
			V _{CC} = 2.5 V ± 0.2 V	2.5	6.1	
			V _{CC} = 3.3 V ± 0.3 V	2.2	5.4	
			V _{CC} = 5 V ± 0.5 V	1.8	4.5	
t _{dis} ⁽³⁾	INH	COM or Y	V _{CC} = 1.8 V ± 0.15 V	3.2	10.9	ns
			V _{CC} = 2.5 V ± 0.2 V	2.3	8.3	
			V _{CC} = 3.3 V ± 0.3 V	2.3	8.1	
			V _{CC} = 5 V ± 0.5 V	1.6	8	
t _{en} ⁽²⁾	A	COM or Y	V _{CC} = 1.8 V ± 0.15 V	2.9	10.3	ns
			V _{CC} = 2.5 V ± 0.2 V	2.1	7.2	
			V _{CC} = 3.3 V ± 0.3 V	1.9	5.8	
			V _{CC} = 5 V ± 0.5 V	1.3	5.4	
t _{dis} ⁽³⁾	A	COM or Y	V _{CC} = 1.8 V ± 0.15 V	2.1	2.1	ns
			V _{CC} = 2.5 V ± 0.2 V	1.4	7.9	
			V _{CC} = 3.3 V ± 0.3 V	1.1	7.2	
			V _{CC} = 5 V ± 0.5 V	1	5	

- (1) t_{PLH} and t_{PHL} are the same as t_{pd}. The propagation delay is the calculated RC time constant of the typical on-state resistance of the switch and the specified load capacitance, when driven by an ideal voltage source (zero output impedance).
- (2) t_{PZL} and t_{PZH} are the same as t_{en}.
- (3) t_{PLZ} and t_{PHZ} are the same as t_{dis}.

6.7 Analog Switch Characteristics

 T_A = 25°C

PARAMETER	FROM (INPUT)	TO (OUTPUT)	TEST CONDITIONS	V _{CC}	TYP	UNIT
Frequency response (switch on)	COM or Y	Y or COM	C _L = 50 pF, R _L = 600 Ω, f _{in} = sine wave (see Figure 6)	1.65 V	35	MHz
				2.3 V	120	
				3 V	190	
				4.5 V	215	
			C _L = 5 pF, R _L = 50 Ω, f _{in} = sine wave (see Figure 6)	1.65 V	>300	
				2.3 V	>300	
				3 V	>300	
				4.5 V	>300	
Crosstalk ⁽¹⁾ (between switches)	COM or Y	Y or COM	C _L = 50 pF, R _L = 600 Ω, f _{in} = 1 MHz (sine wave) (see Figure 7)	1.65 V	-58	dB
				2.3 V	-58	
				3 V	-58	
				4.5 V	-58	
			C _L = 5 pF, R _L = 50 Ω, f _{in} = 1 MHz (sine wave) (see Figure 7)	1.65 V	-42	
				2.3 V	-42	
				3 V	-42	
				4.5 V	-42	

- (1) Adjust f_{in} voltage to obtain 0 dBm at input.

Analog Switch Characteristics (continued)
 $T_A = 25^\circ\text{C}$

PARAMETER	FROM (INPUT)	TO (OUTPUT)	TEST CONDITIONS	V _{CC}	TYP	UNIT
Crosstalk (control input to signal output)	INH	COM or Y	$C_L = 50\text{ pF}$, $R_L = 600\ \Omega$, $f_{in} = 1\text{ MHz}$ (square wave) (see Figure 8)	1.65 V	35	mV
				2.3 V	50	
				3 V	70	
				4.5 V	100	
Feedthrough attenuation (switch off)	COM or Y	Y or COM	$C_L = 50\text{ pF}$, $R_L = 600\ \Omega$, $f_{in} = 1\text{ MHz}$ (sine wave) (see Figure 9)	1.65 V	–60	dB
				2.3 V	–60	
				3 V	–60	
				4.5 V	–60	
			$C_L = 5\text{ pF}$, $R_L = 50\ \Omega$, $f_{in} = 1\text{ MHz}$ (sine wave) (see Figure 9)	1.65 V	–50	
				2.3 V	–50	
				3 V	–50	
				4.5 V	–50	
Sine-wave distortion	COM or Y	Y or COM	$C_L = 50\text{ pF}$, $R_L = 10\text{ k}\Omega$, $f_{in} = 1\text{ kHz}$ (sine wave) (see Figure 10)	1.65 V	0.1%	
				2.3 V	0.025%	
				3 V	0.015%	
				4.5 V	0.01%	
			$C_L = 50\text{ pF}$, $R_L = 10\text{ k}\Omega$, $f_{in} = 10\text{ kHz}$ (sine wave) (see Figure 10)	1.65 V	0.15%	
				2.3 V	0.025%	
				3 V	0.015%	
				4.5 V	0.01%	

6.8 Operating Characteristics
 $T_A = 25^\circ\text{C}$

PARAMETER	TEST CONDITIONS	V _{CC}	TYP	UNIT
C _{pd} Power dissipation capacitance	C _L = 50 pF, f = 10 MHz	V _{CC} = 1.8 V	9	pF
		V _{CC} = 2.5 V	10	
		V _{CC} = 3.3 V	10	
		V _{CC} = 5 V	12	

6.9 Typical Characteristics

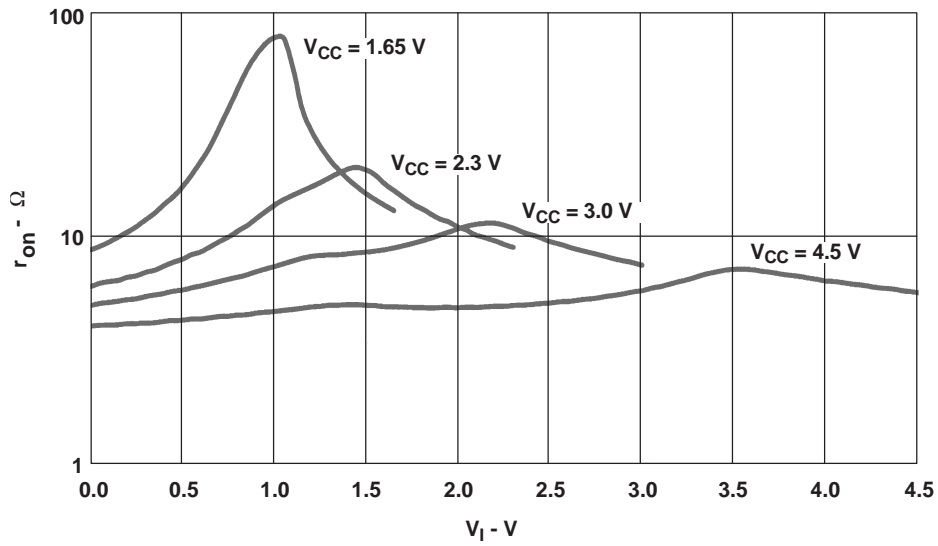

Figure 1. Typical r_{on} as a Function of Input Voltage (V_I) for $V_I = 0$ to V_{CC}

7 Parameter Measurement Information

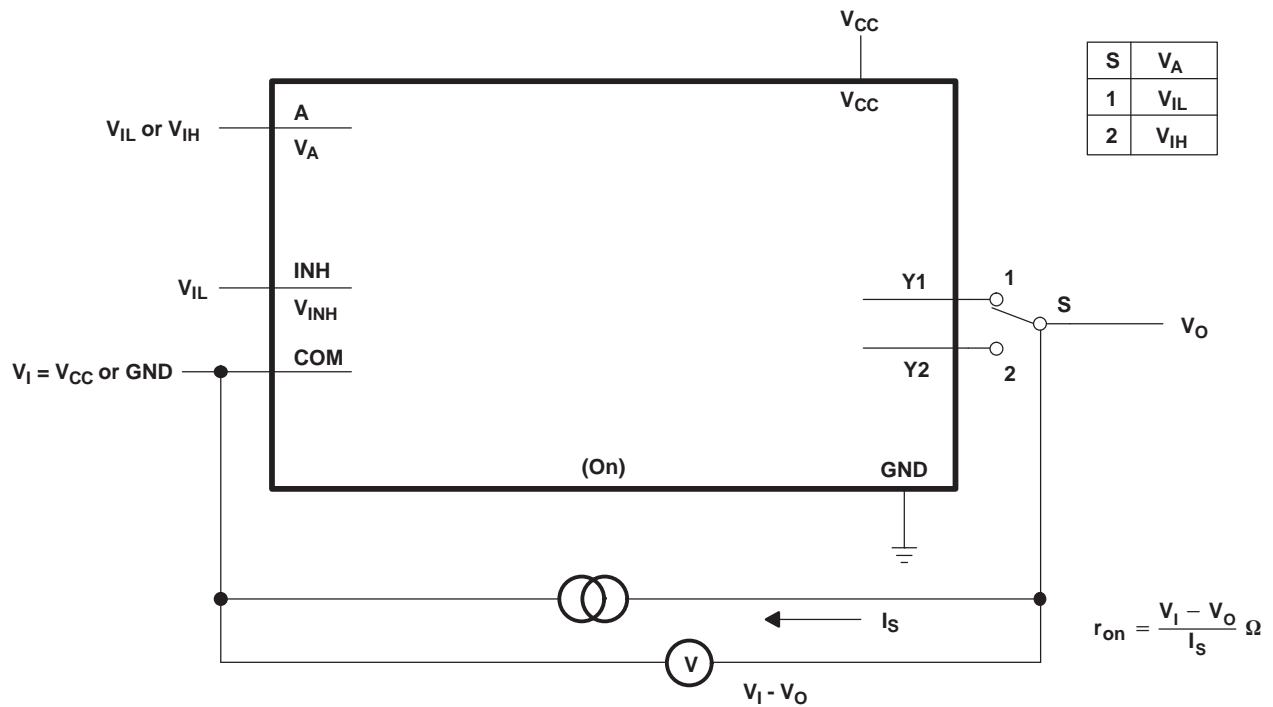

Figure 2. ON-State Resistance Test Circuit

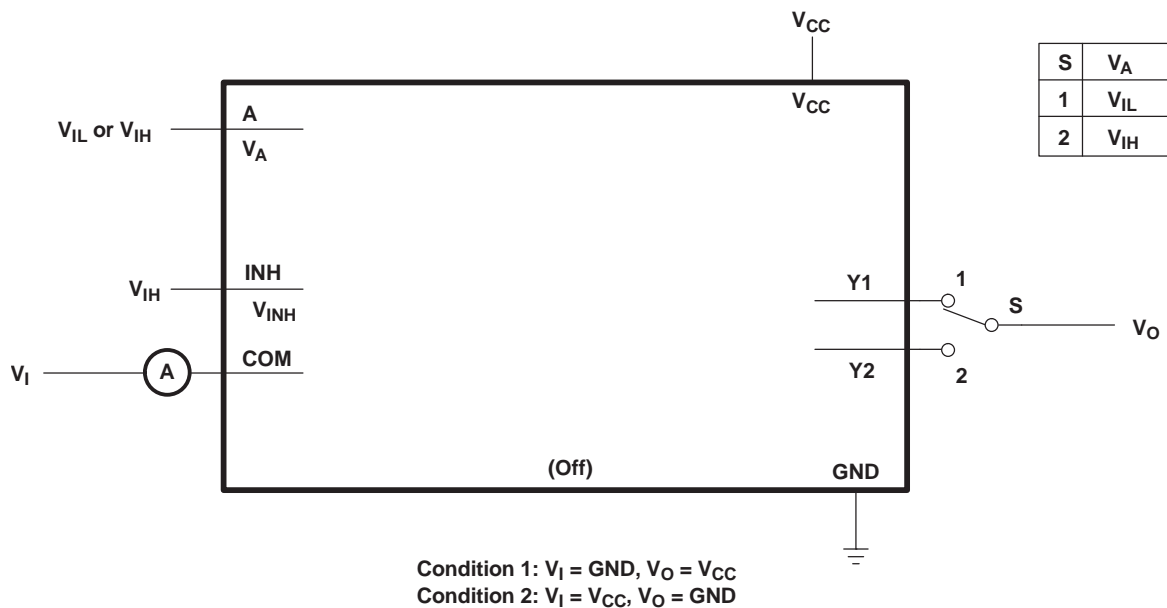
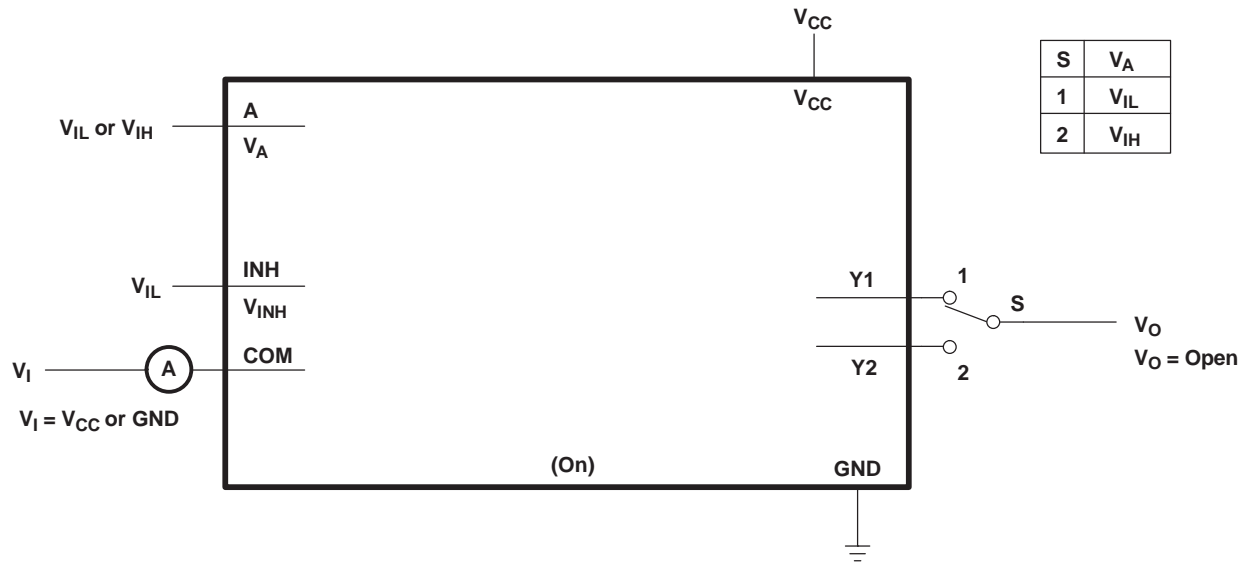
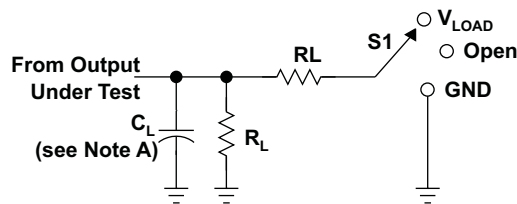

Figure 3. OFF-State Switch Leakage-Current Test Circuit

Parameter Measurement Information (continued)

Figure 4. ON-State Switch Leakage-Current Test Circuit

Parameter Measurement Information (continued)



LOAD CIRCUIT

TEST	S1
t_{PLH}/t_{PHL}	Open
t_{PLZ}/t_{PZL}	V_{LOAD}
t_{PHZ}/t_{PZH}	GND

V_{CC}	INPUTS		V_M	V_{LOAD}	C_L	R_L	V_{Δ}
	V_I	t_r/t_f					
$1.8\text{ V} \pm 0.15\text{ V}$	V_{CC}	$\leq 2\text{ ns}$	$V_{CC}/2$	$2 \times V_{CC}$	30 pF	1 k Ω	0.15 V
$2.5\text{ V} \pm 0.2\text{ V}$	V_{CC}	$\leq 2\text{ ns}$	$V_{CC}/2$	$2 \times V_{CC}$	30 pF	500 Ω	0.15 V
$3.3\text{ V} \pm 0.3\text{ V}$	V_{CC}	$\leq 2.5\text{ ns}$	$V_{CC}/2$	$2 \times V_{CC}$	50 pF	500 Ω	0.3 V
$5\text{ V} \pm 0.5\text{ V}$	V_{CC}	$\leq 2.5\text{ ns}$	$V_{CC}/2$	$2 \times V_{CC}$	50 pF	500 Ω	0.3 V

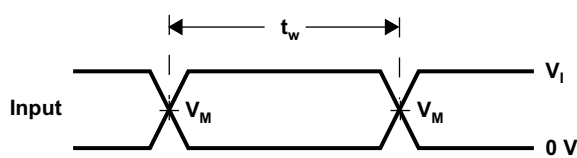

VOLTAGE WAVEFORMS PULSE DURATION

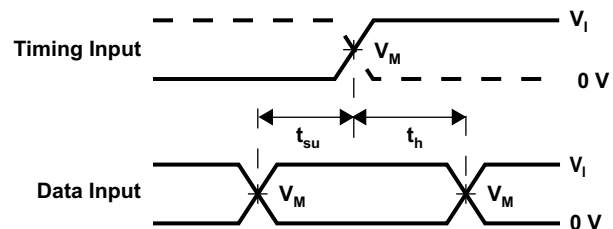

VOLTAGE WAVEFORMS SETUP AND HOLD TIMES

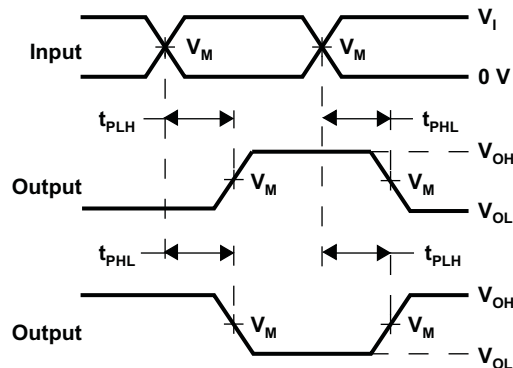

VOLTAGE WAVEFORMS PROPAGATION DELAY TIMES INVERTING AND NONINVERTING OUTPUTS

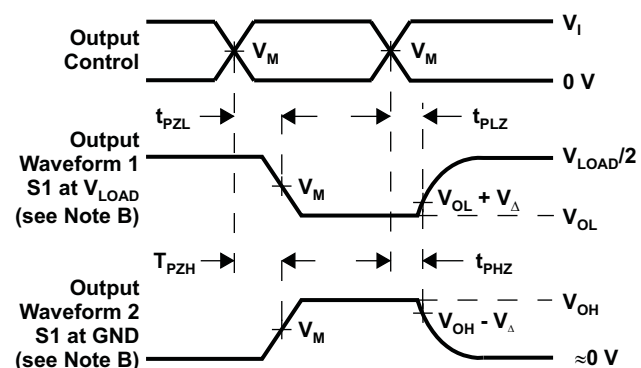

VOLTAGE WAVEFORMS ENABLE AND DISABLE TIMES LOW- AND HIGH-LEVEL ENABLING

- NOTES: A. C_L includes probe and jig capacitance.
 B. Waveform 1 is for an output with internal conditions such that the output is low, except when disabled by the output control. Waveform 2 is for an output with internal conditions such that the output is high, except when disabled by the output control.
 C. All input pulses are supplied by generators having the following characteristics: PRR $\leq 10\text{ Mhz}$, $Z_O = 50\ \Omega$
 D. The outputs are measured one at a time, with one transition per measurement.
 E. t_{PLZ} and t_{PHZ} are the same as t_{dis} .
 F. t_{PZL} and t_{PZH} are the same as t_{en} .
 G. t_{PLH} and t_{PHL} are the same as t_{pd} .
 H. All parameters and waveforms are not applicable to all devices.

Figure 5. Load Circuit and Voltage Waveforms

Parameter Measurement Information (continued)

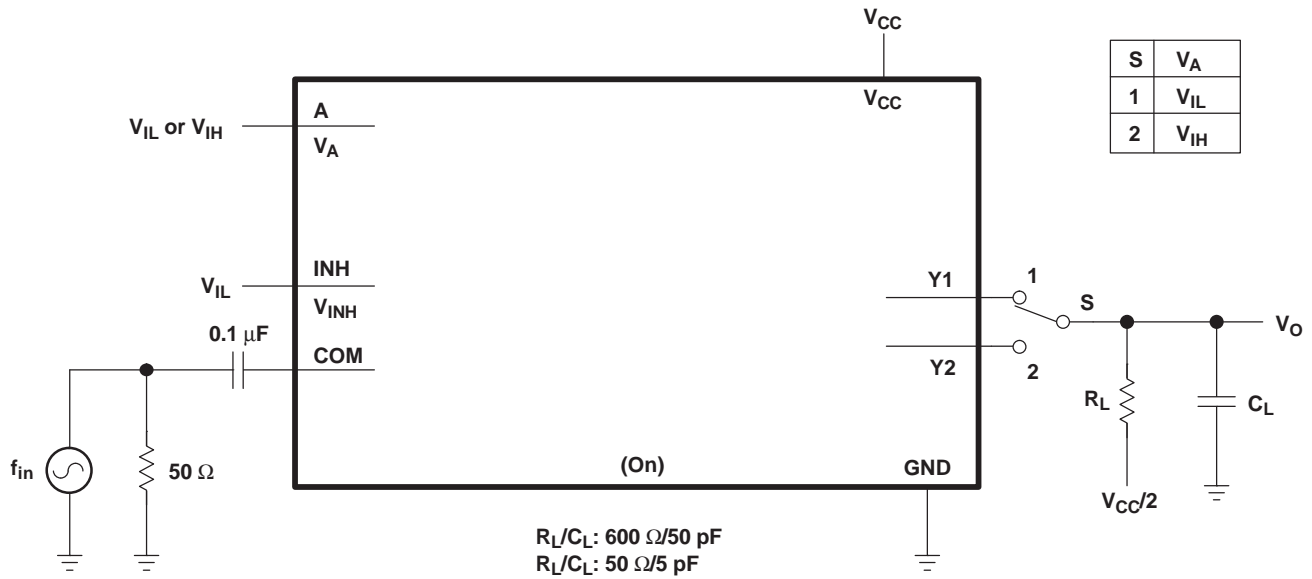

Figure 6. Frequency Response (Switch On)

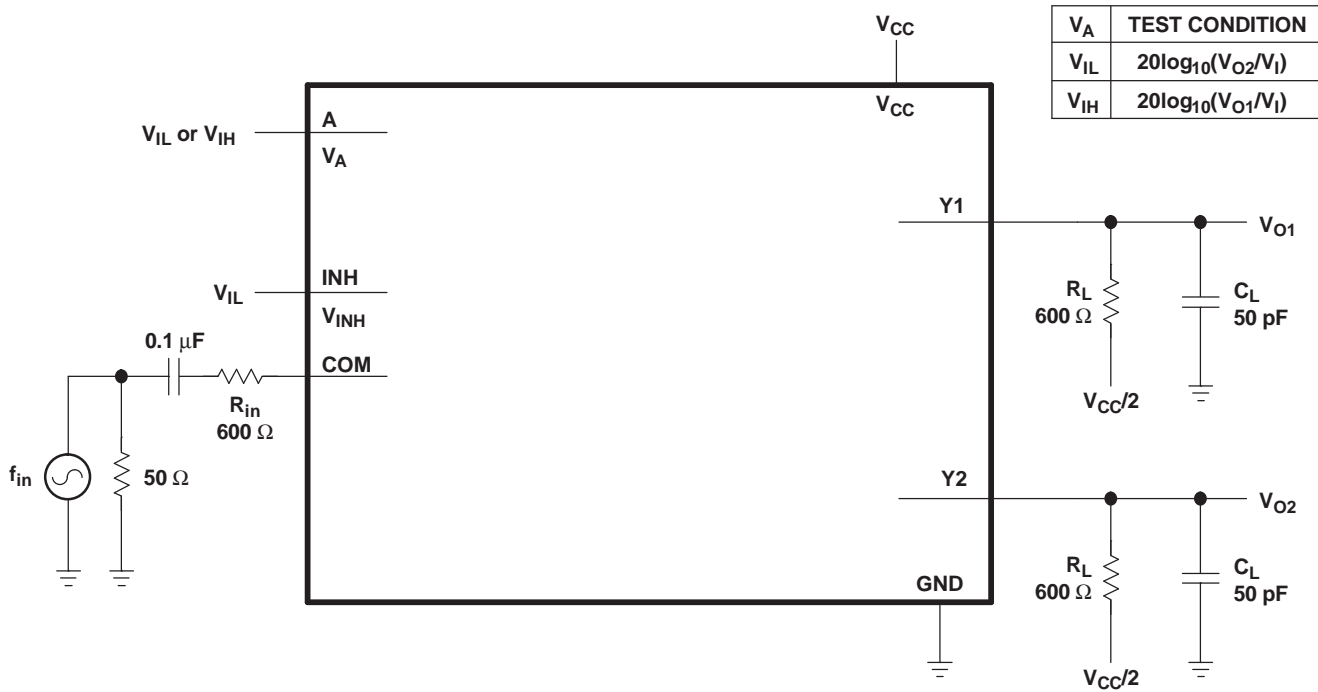

Figure 7. Crosstalk (Between Switches)

Parameter Measurement Information (continued)

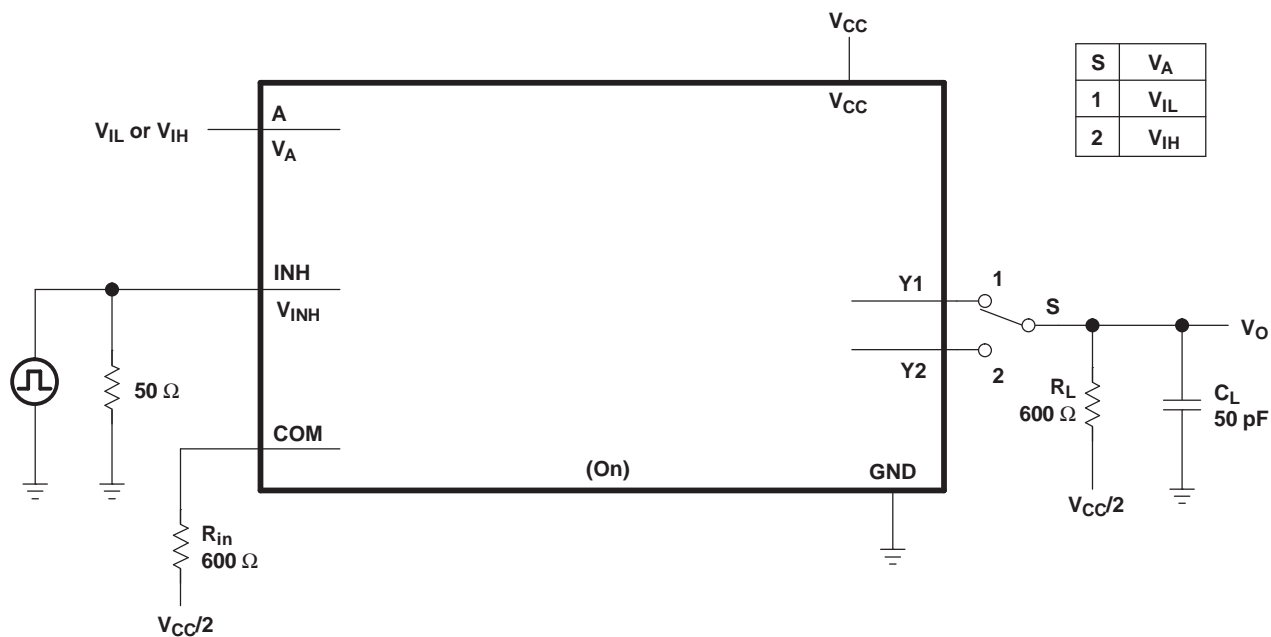

Figure 8. Crosstalk (Control Input, Switch Output)

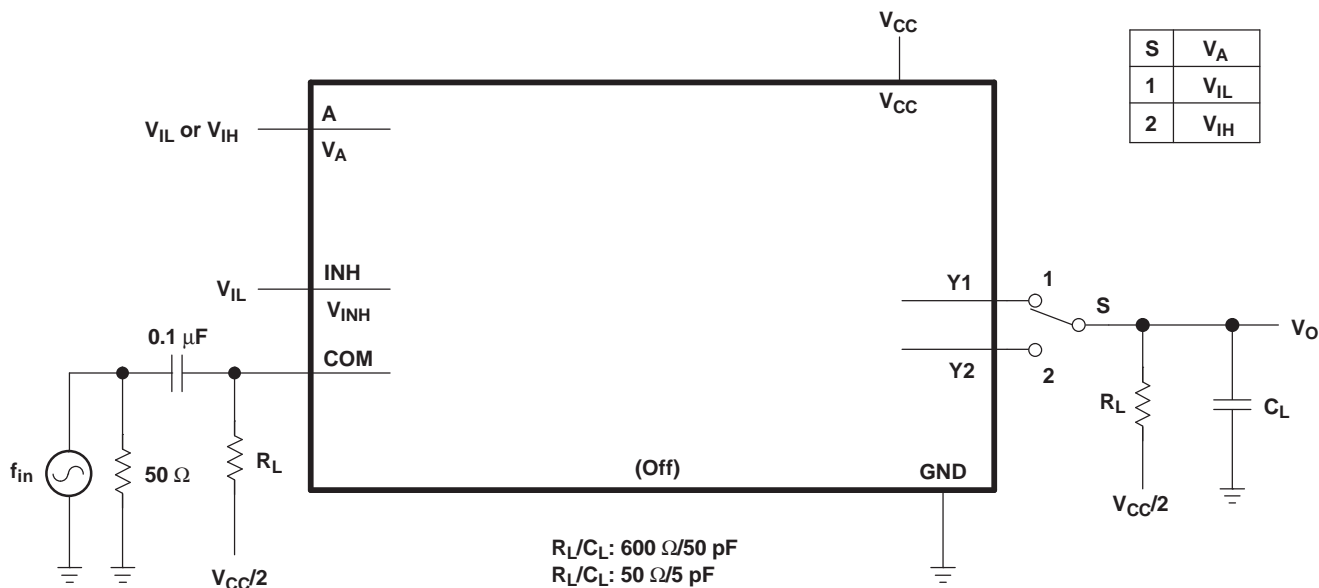
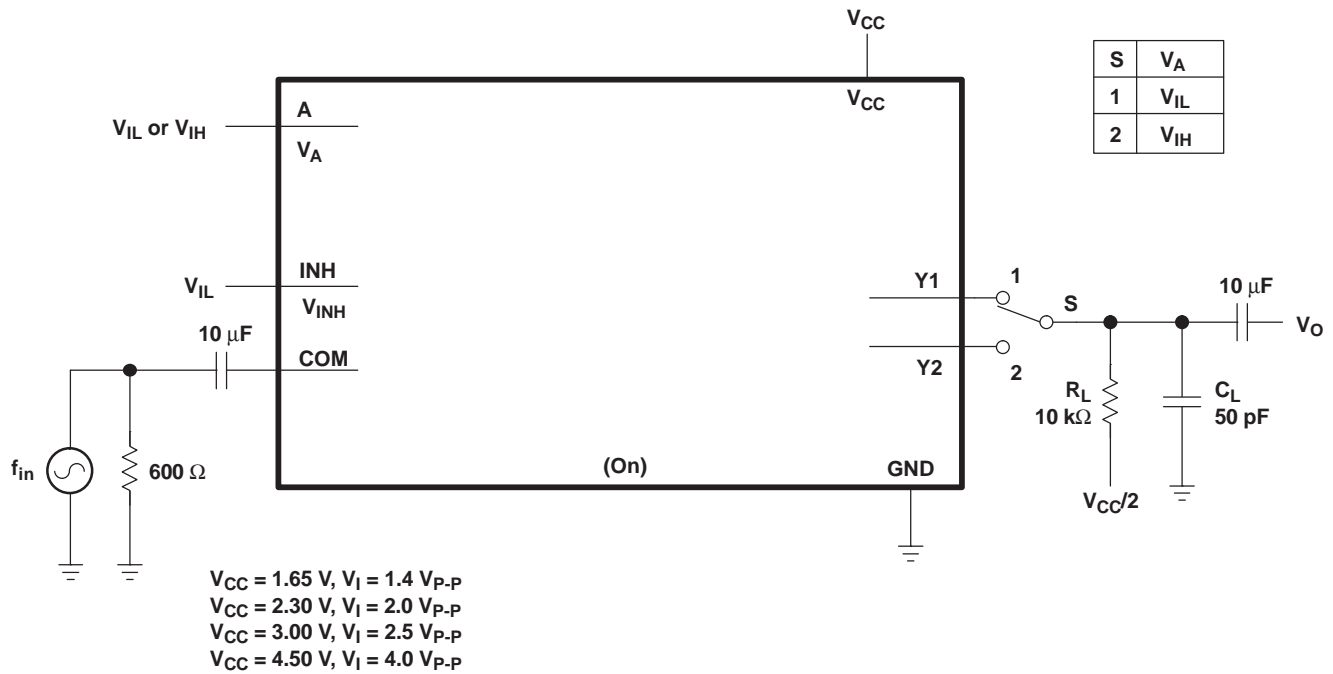

Figure 9. Feedthrough (Switch Off)

Parameter Measurement Information (continued)

Figure 10. Sine-Wave Distortion

8 Detailed Description

8.1 Overview

This dual analog multiplexer/demultiplexer is designed for 1.65-V to 5.5-V V_{CC} operation.

The SN74LVC2G53 device can handle both analog and digital signals. This device permits signals with amplitudes of up to 5.5 V (peak) to be transmitted in either direction.

8.2 Functional Block Diagram

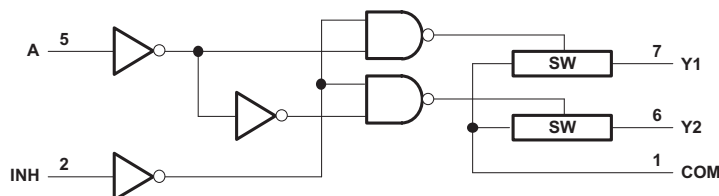

NOTE: For simplicity, the test conditions shown in [Figure 1](#) through [Figure 4](#) and [Figure 6](#) through [Figure 10](#) are for the demultiplexer configuration. Signals can be passed from COM to Y1 (Y2) or from Y1 (Y2) to COM.

Figure 11. Logic Diagram

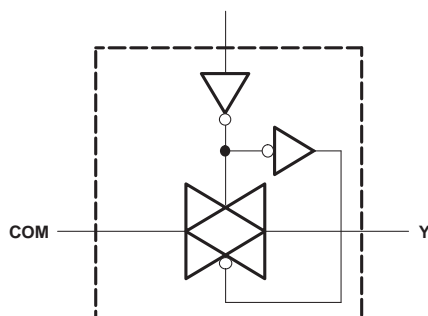

Figure 12. Logic Diagram, Each Switch (SW)

8.3 Feature Description

A high-level voltage applied to INH disables the switches. When INH is low, signals can pass from A to Y or Y to A. Low ON-resistance of 6.5 Ω at 4.5-V V_{CC} is ideal for analog signal conditioning systems. The control signals can accept voltages up to 5.5 V without V_{CC} connected in the system. Combination of lower t_{pd} of 0.8 ns at 3.3 V and low enable and disable time make this part suitable for high-speed signal switching applications.

8.4 Device Functional Modes

[Table 1](#) lists the functional modes of the SN74LVC2G53.

Table 1. Function Table

CONTROL INPUTS		ON CHANNEL
INH	A	
L	L	Y1
L	H	Y2
H	X	None

9 Application and Implementation

NOTE

Information in the following applications sections is not part of the TI component specification, and TI does not warrant its accuracy or completeness. TI's customers are responsible for determining suitability of components for their purposes. Customers should validate and test their design implementation to confirm system functionality.

9.1 Application Information

The SN74LVC2G53 can be used in any situation where an SPDT switch is required in an application. This switch helps to select one of two signals of which signals can be either digital or analog.

9.2 Typical Application

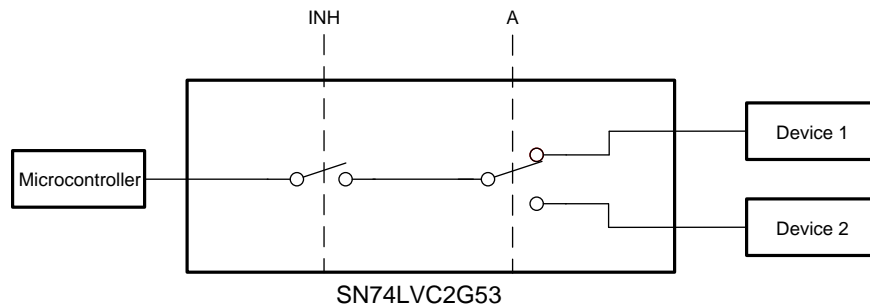

Figure 13. Typical Application Schematic

9.2.1 Design Requirements

The SN74LVC2G53 allows on/off control of analog and digital signals with a digital control signal. All input signals should remain between 0 V and V_{CC} for optimal operation.

9.2.2 Detailed Design Procedure

1. Recommended Input Conditions:
 - For rise time and fall time specifications, see $\Delta t/\Delta v$ in the [Recommended Operating Conditions](#) table.
 - For specified high and low levels, see V_{IH} and V_{IL} in the [Recommended Operating Conditions](#) table.
 - Inputs and outputs are overvoltage tolerant allowing them to go as high as 5.5 V at any valid V_{CC} .
2. Recommended Output Conditions:
 - Load currents should not exceed ± 50 mA.
3. Frequency Selection Criterion:
 - Maximum frequency tested is 150 MHz.
 - Added trace resistance or capacitance can reduce maximum frequency capability; use layout practices as directed in [Layout](#).

Typical Application (continued)

9.2.3 Application Curve

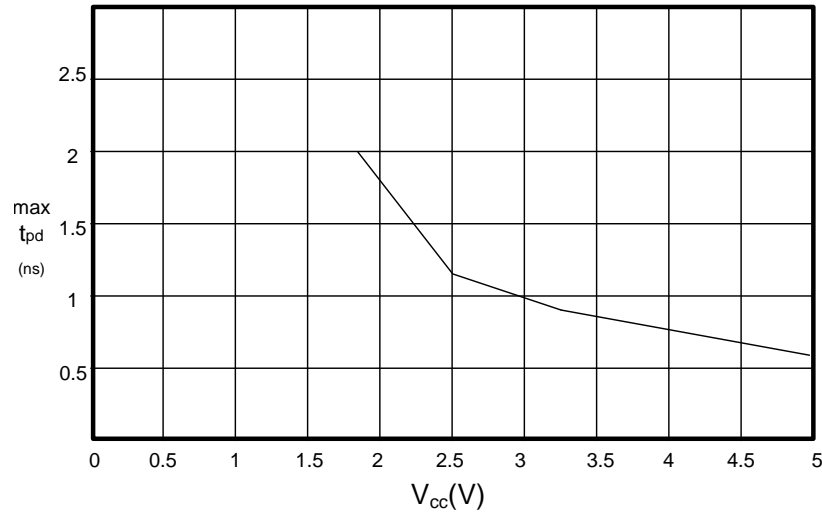

Figure 14. t_{pd} vs V_{CC}

10 Power Supply Recommendations

The power supply can be any voltage between the minimum and maximum supply voltage rating located in the [Absolute Maximum Ratings](#).

Each V_{CC} terminal should have a good bypass capacitor to prevent power disturbance. For devices with a single supply, a 0.1- μ F bypass capacitor is recommended. If there are multiple pins labeled V_{CC} , then a 0.01- μ F or 0.022- μ F capacitor is recommended for each V_{CC} because the V_{CC} pins will be tied together internally. For devices with dual-supply pins operating at different voltages, for example V_{CC} and V_{DD} , a 0.1- μ F bypass capacitor is recommended for each supply pin. It is acceptable to parallel multiple bypass capacitors to reject different frequencies of noise. 0.1- μ F and 1- μ F capacitors are commonly used in parallel. The bypass capacitor should be installed as close to the power terminal as possible for best results.

11 Layout

11.1 Layout Guidelines

Reflections and matching are closely related to loop antenna theory, but different enough to warrant their own discussion. When a PCB trace turns a corner at a 90° angle, a reflection can occur. This is primarily due to the change of width of the trace. At the apex of the turn, the trace width is increased to 1.414 times its width. This upsets the transmission line characteristics, especially the distributed capacitance and self-inductance of the trace — resulting in the reflection.

NOTE

Not all PCB traces can be straight, and so they will have to turn corners. [Figure 15](#) shows progressively better techniques of rounding corners. Only the last example maintains constant trace width and minimizes reflections.

11.2 Layout Example

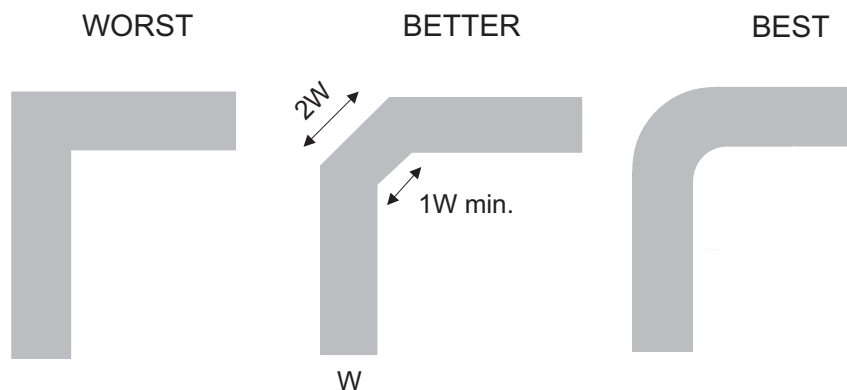

Figure 15. Trace Example

12 デバイスおよびドキュメントのサポート

12.1 ドキュメントのサポート

12.1.1 関連資料

関連資料については、以下を参照してください。

『[低速またはフローティングCMOS入力の影響](#)』、SCBA004

12.2 ドキュメントの更新通知を受け取る方法

ドキュメントの更新についての通知を受け取るには、[ti.com](#)のデバイス製品フォルダを開いてください。右上の「アラートを受け取る」をクリックして登録すると、変更されたすべての製品情報に関するダイジェストを毎週受け取れます。変更の詳細については、修正されたドキュメントに含まれている改訂履歴をご覧ください。

12.3 コミュニティ・リソース

The following links connect to TI community resources. Linked contents are provided "AS IS" by the respective contributors. They do not constitute TI specifications and do not necessarily reflect TI's views; see TI's [Terms of Use](#).

TI E2E™オンライン・コミュニティ *TIのE2E (Engineer-to-Engineer)* コミュニティ。エンジニア間の共同作業を促進するために開設されたものです。e2e.ti.comでは、他のエンジニアに質問し、知識を共有し、アイデアを検討して、問題解決に役立てることができます。

設計サポート *TIの設計サポート* 役に立つE2Eフォーラムや、設計サポート・ツールをすばやく見つけることができます。技術サポート用の連絡先情報も参照できます。

12.4 商標

NanoFree, E2E are trademarks of Texas Instruments.
All other trademarks are the property of their respective owners.

12.5 静電気放電に関する注意事項



これらのデバイスは、限定的なESD(静電破壊)保護機能を内蔵しています。保存時または取り扱い時は、MOSゲートに対する静電破壊を防止するために、リード線同士をショートさせておくか、デバイスを導電フォームに入れる必要があります。

12.6 Glossary

SLYZ022 — *TI Glossary*.

This glossary lists and explains terms, acronyms, and definitions.

13 メカニカル、パッケージ、および注文情報

以降のページには、メカニカル、パッケージ、および注文に関する情報が記載されています。この情報は、そのデバイスについて利用可能な最新のデータです。このデータは予告なく変更されることがあり、ドキュメントが改訂される場合もあります。本データシートのブラウザ版を使用されている場合は、画面左側の説明をご覧ください。

PACKAGING INFORMATION

Orderable Device	Status (1)	Package Type	Package Drawing	Pins	Package Qty	Eco Plan (2)	Lead finish/ Ball material (6)	MSL Peak Temp (3)	Op Temp (°C)	Device Marking (4/5)	Samples
SN74LVC2G53DCT3	OBSOLETE	SSOP	DCT	8		TBD	Call TI	Call TI	-40 to 85	C53 Z	
SN74LVC2G53DCTR	ACTIVE	SSOP	DCT	8	3000	RoHS & Green	NIPDAU	Level-1-260C-UNLIM	-40 to 85	C53 Z	Samples
SN74LVC2G53DCUR	ACTIVE	VSSOP	DCU	8	3000	RoHS & Green	NIPDAU SN	Level-1-260C-UNLIM	-40 to 85	(53, C53Q, C53R) CZ	Samples
SN74LVC2G53DCURG4	ACTIVE	VSSOP	DCU	8	3000	RoHS & Green	NIPDAU	Level-1-260C-UNLIM	-40 to 85	C53R	Samples
SN74LVC2G53DCUT	OBSOLETE	VSSOP	DCU	8		TBD	Call TI	Call TI	-40 to 85	(53, C53Q, C53R) CZ	
SN74LVC2G53DCUTG4	ACTIVE	VSSOP	DCU	8	250	RoHS & Green	NIPDAU	Level-1-260C-UNLIM		C53R	Samples
SN74LVC2G53YZPR	ACTIVE	DSBGA	YZP	8	3000	RoHS & Green	SNAGCU	Level-1-260C-UNLIM	-40 to 85	C4N	Samples

(1) The marketing status values are defined as follows:

ACTIVE: Product device recommended for new designs.

LIFEBUY: TI has announced that the device will be discontinued, and a lifetime-buy period is in effect.

NRND: Not recommended for new designs. Device is in production to support existing customers, but TI does not recommend using this part in a new design.

PREVIEW: Device has been announced but is not in production. Samples may or may not be available.

OBSOLETE: TI has discontinued the production of the device.

(2) **RoHS:** TI defines "RoHS" to mean semiconductor products that are compliant with the current EU RoHS requirements for all 10 RoHS substances, including the requirement that RoHS substance do not exceed 0.1% by weight in homogeneous materials. Where designed to be soldered at high temperatures, "RoHS" products are suitable for use in specified lead-free processes. TI may reference these types of products as "Pb-Free".

RoHS Exempt: TI defines "RoHS Exempt" to mean products that contain lead but are compliant with EU RoHS pursuant to a specific EU RoHS exemption.

Green: TI defines "Green" to mean the content of Chlorine (Cl) and Bromine (Br) based flame retardants meet JS709B low halogen requirements of <=1000ppm threshold. Antimony trioxide based flame retardants must also meet the <=1000ppm threshold requirement.

(3) MSL, Peak Temp. - The Moisture Sensitivity Level rating according to the JEDEC industry standard classifications, and peak solder temperature.

(4) There may be additional marking, which relates to the logo, the lot trace code information, or the environmental category on the device.

(5) Multiple Device Markings will be inside parentheses. Only one Device Marking contained in parentheses and separated by a "~" will appear on a device. If a line is indented then it is a continuation of the previous line and the two combined represent the entire Device Marking for that device.

⁽⁶⁾ Lead finish/Ball material - Orderable Devices may have multiple material finish options. Finish options are separated by a vertical ruled line. Lead finish/Ball material values may wrap to two lines if the finish value exceeds the maximum column width.

Important Information and Disclaimer:The information provided on this page represents TI's knowledge and belief as of the date that it is provided. TI bases its knowledge and belief on information provided by third parties, and makes no representation or warranty as to the accuracy of such information. Efforts are underway to better integrate information from third parties. TI has taken and continues to take reasonable steps to provide representative and accurate information but may not have conducted destructive testing or chemical analysis on incoming materials and chemicals. TI and TI suppliers consider certain information to be proprietary, and thus CAS numbers and other limited information may not be available for release.

In no event shall TI's liability arising out of such information exceed the total purchase price of the TI part(s) at issue in this document sold by TI to Customer on an annual basis.

TAPE AND REEL INFORMATION

QUADRANT ASSIGNMENTS FOR PIN 1 ORIENTATION IN TAPE

*All dimensions are nominal

Device	Package Type	Package Drawing	Pins	SPQ	Reel Diameter (mm)	Reel Width W1 (mm)	A0 (mm)	B0 (mm)	K0 (mm)	P1 (mm)	W (mm)	Pin1 Quadrant
SN74LVC2G53DCTR	SSOP	DCT	8	3000	180.0	13.0	3.35	4.5	1.55	4.0	12.0	Q3
SN74LVC2G53DCUR	VSSOP	DCU	8	3000	178.0	9.0	2.25	3.35	1.05	4.0	8.0	Q3
SN74LVC2G53DCURG4	VSSOP	DCU	8	3000	180.0	8.4	2.25	3.35	1.05	4.0	8.0	Q3
SN74LVC2G53DCUTG4	VSSOP	DCU	8	250	180.0	8.4	2.25	3.35	1.05	4.0	8.0	Q3
SN74LVC2G53YZPR	DSBGA	YZP	8	3000	178.0	9.2	1.02	2.02	0.63	4.0	8.0	Q1

TAPE AND REEL BOX DIMENSIONS

*All dimensions are nominal

Device	Package Type	Package Drawing	Pins	SPQ	Length (mm)	Width (mm)	Height (mm)
SN74LVC2G53DCTR	SSOP	DCT	8	3000	182.0	182.0	20.0
SN74LVC2G53DCUR	VSSOP	DCU	8	3000	180.0	180.0	18.0
SN74LVC2G53DCURG4	VSSOP	DCU	8	3000	202.0	201.0	28.0
SN74LVC2G53DCUTG4	VSSOP	DCU	8	250	202.0	201.0	28.0
SN74LVC2G53YZPR	DSBGA	YZP	8	3000	220.0	220.0	35.0

DCU0008A



PACKAGE OUTLINE

VSSOP - 0.9 mm max height

SMALL OUTLINE PACKAGE

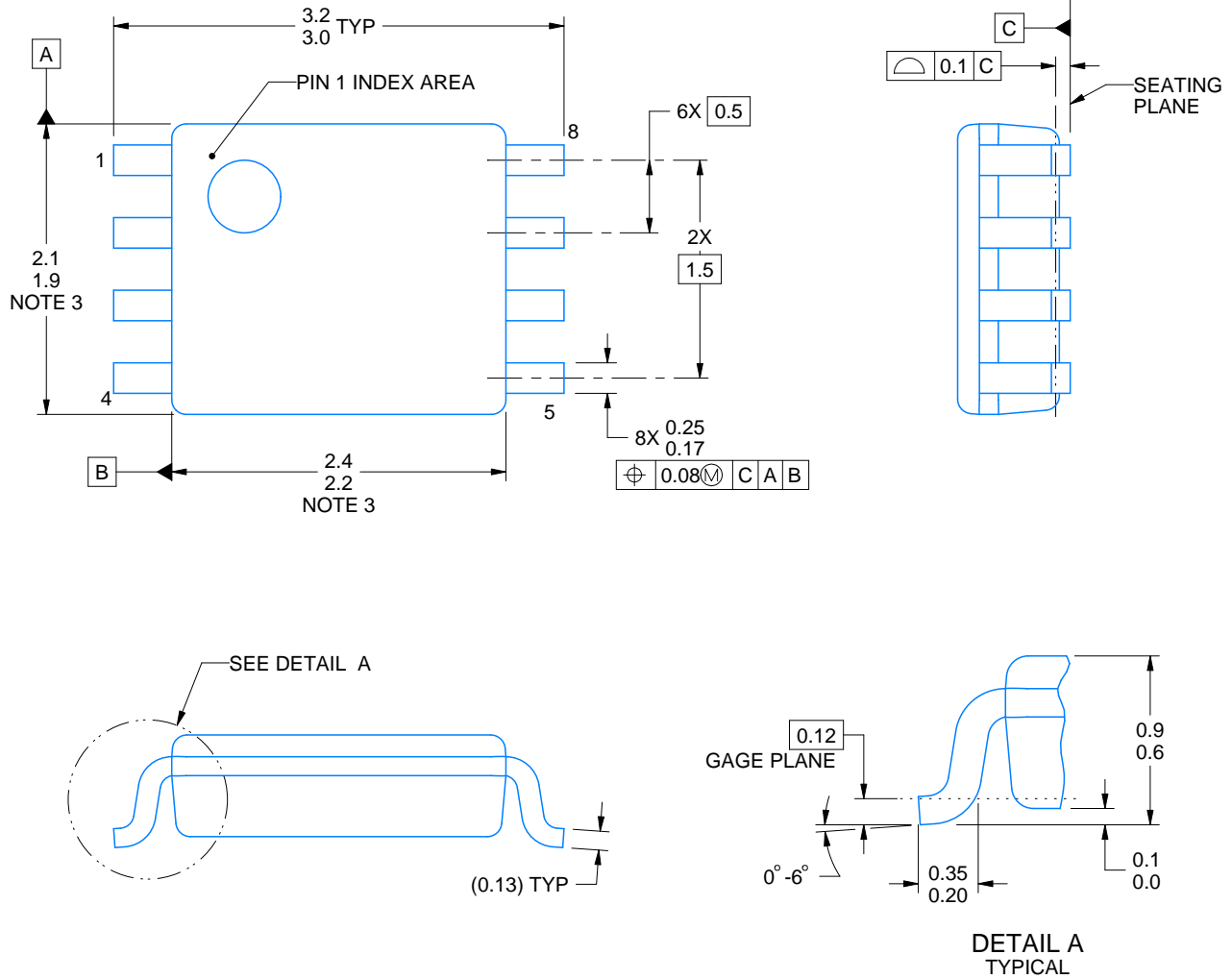

4225266/A 09/2014

NOTES:

1. All linear dimensions are in millimeters. Any dimensions in parenthesis are for reference only. Dimensioning and tolerancing per ASME Y14.5M.
2. This drawing is subject to change without notice.
3. This dimension does not include mold flash, protrusions, or gate burrs. Mold flash, protrusions, or gate burrs shall not exceed 0.15 mm per side.
4. Reference JEDEC registration MO-187 variation CA.

EXAMPLE BOARD LAYOUT

DCU0008A

VSSOP - 0.9 mm max height

SMALL OUTLINE PACKAGE

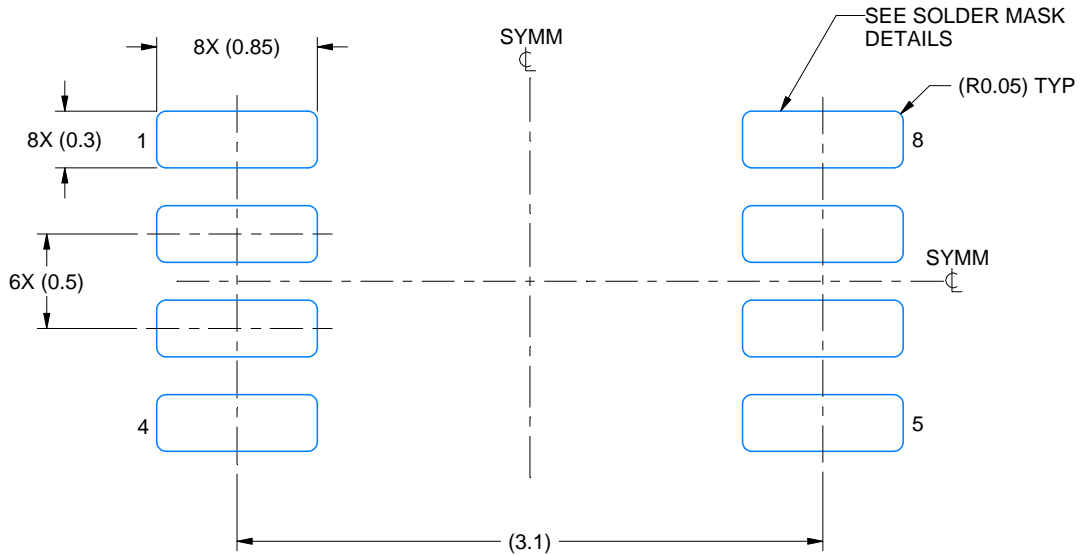

LAND PATTERN EXAMPLE
EXPOSED METAL SHOWN
SCALE: 25X



4225266/A 09/2014

NOTES: (continued)

- 5. Publication IPC-7351 may have alternate designs.
- 6. Solder mask tolerances between and around signal pads can vary based on board fabrication site.

EXAMPLE STENCIL DESIGN

DCU0008A

VSSOP - 0.9 mm max height

SMALL OUTLINE PACKAGE



SOLDER PASTE EXAMPLE
BASED ON 0.125 mm THICK STENCIL
SCALE: 25X

4225266/A 09/2014

NOTES: (continued)

7. Laser cutting apertures with trapezoidal walls and rounded corners may offer better paste release. IPC-7525 may have alternate design recommendations.
8. Board assembly site may have different recommendations for stencil design.

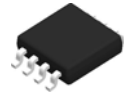

4220784/C 06/2021

NOTES:

- All linear dimensions are in millimeters. Dimensions in parenthesis are for reference only. Dimensioning and tolerancing per ASME Y14.5M.
- This drawing is subject to change without notice.
- This dimension does not include mold flash, protrusions, or gate burrs. Mold flash, protrusions, or gate burrs shall not exceed 0.15 mm per side.
- This dimension does not include interlead flash. Interlead flash shall not exceed 0.25 mm per side.

EXAMPLE BOARD LAYOUT

DCT0008A

SSOP - 1.3 mm max height

SMALL OUTLINE PACKAGE

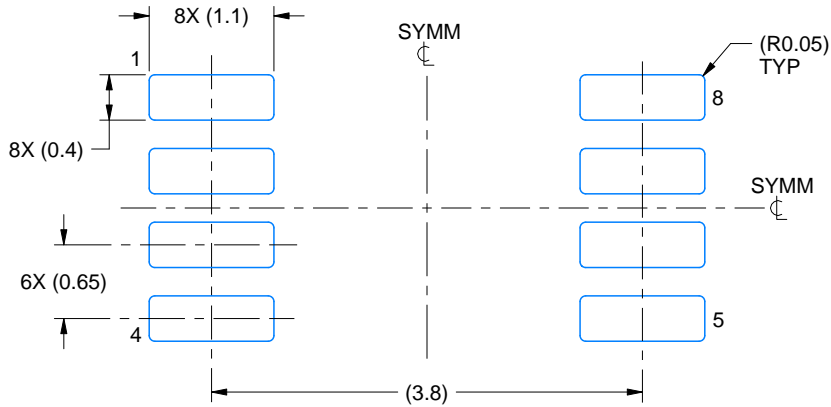

LAND PATTERN EXAMPLE
EXPOSED METAL SHOWN
SCALE:15X

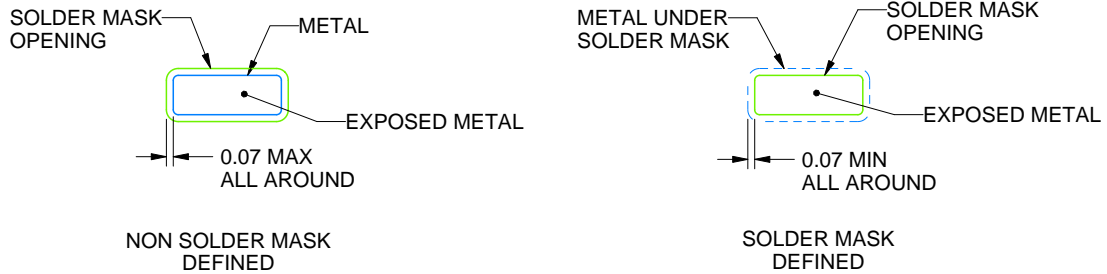

SOLDER MASK DETAILS

4220784/C 06/2021

NOTES: (continued)

- 5. Publication IPC-7351 may have alternate designs.
- 6. Solder mask tolerances between and around signal pads can vary based on board fabrication site.

EXAMPLE STENCIL DESIGN

DCT0008A

SSOP - 1.3 mm max height

SMALL OUTLINE PACKAGE

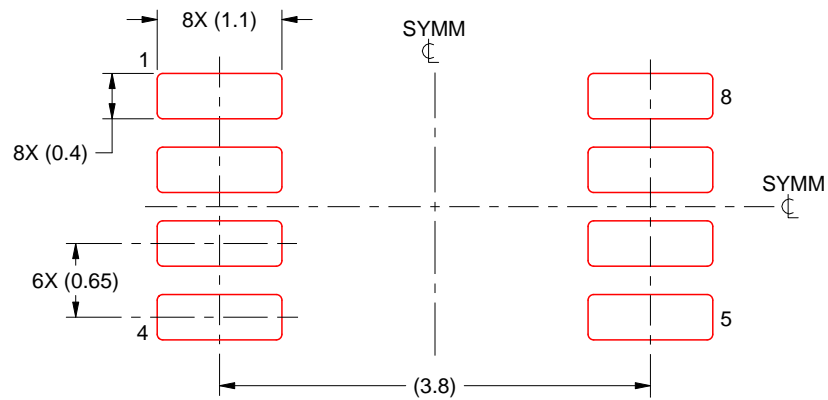

SOLDER PASTE EXAMPLE
BASED ON 0.125 mm THICK STENCIL
SCALE:15X

4220784/C 06/2021

NOTES: (continued)

7. Laser cutting apertures with trapezoidal walls and rounded corners may offer better paste release. IPC-7525 may have alternate design recommendations.
8. Board assembly site may have different recommendations for stencil design.

EXAMPLE BOARD LAYOUT

YZP0008

DSBGA - 0.5 mm max height

DIE SIZE BALL GRID ARRAY



LAND PATTERN EXAMPLE
SCALE:40X



SOLDER MASK DETAILS
NOT TO SCALE

4223082/A 07/2016

NOTES: (continued)

3. Final dimensions may vary due to manufacturing tolerance considerations and also routing constraints. For more information, see Texas Instruments literature number SNVA009 (www.ti.com/lit/snva009).

EXAMPLE STENCIL DESIGN

YZP0008

DSBGA - 0.5 mm max height

DIE SIZE BALL GRID ARRAY

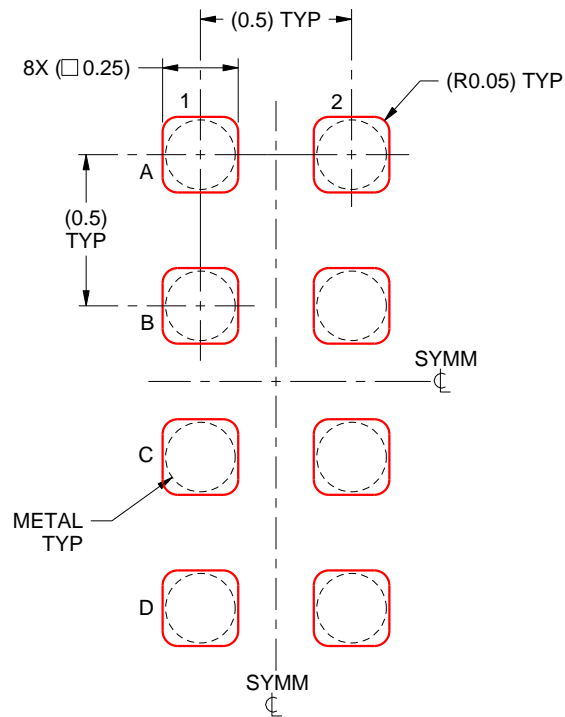

SOLDER PASTE EXAMPLE
BASED ON 0.1 mm THICK STENCIL
SCALE:40X

4223082/A 07/2016

NOTES: (continued)

4. Laser cutting apertures with trapezoidal walls and rounded corners may offer better paste release.

重要なお知らせと免責事項

テキサス・インスツルメンツは、技術データと信頼性データ(データシートを含みます)、設計リソース(リファレンス デザインを含みます)、アプリケーションや設計に関する各種アドバイス、Web ツール、安全性情報、その他のリソースを、欠陥が存在する可能性のある「現状のまま」提供しており、商品性および特定目的に対する適合性の黙示保証、第三者の知的財産権の非侵害保証を含むいかなる保証も、明示的または黙示的にかかわらず拒否します。

これらのリソースは、テキサス・インスツルメンツ製品を使用する設計の経験を積んだ開発者への提供を意図したものです。(1) お客様のアプリケーションに適したテキサス・インスツルメンツ製品の選定、(2) お客様のアプリケーションの設計、検証、試験、(3) お客様のアプリケーションに該当する各種規格や、その他のあらゆる安全性、セキュリティ、規制、または他の要件への確実な適合に関する責任を、お客様のみが単独で負うものとします。

上記の各種リソースは、予告なく変更される可能性があります。これらのリソースは、リソースで説明されているテキサス・インスツルメンツ製品を使用するアプリケーションの開発の目的でのみ、テキサス・インスツルメンツはその使用をお客様に許諾します。これらのリソースに関して、他の目的で複製することや掲載することは禁止されています。テキサス・インスツルメンツや第三者の知的財産権のライセンスが付与されている訳ではありません。お客様は、これらのリソースを自身で使用した結果発生するあらゆる申し立て、損害、費用、損失、責任について、テキサス・インスツルメンツおよびその代理人を完全に補償するものとし、テキサス・インスツルメンツは一切の責任を拒否します。

テキサス・インスツルメンツの製品は、[テキサス・インスツルメンツの販売条件](#)、または [ti.com](https://www.ti.com) やかかるテキサス・インスツルメンツ製品の関連資料などのいずれかを通じて提供する適用可能な条項の下で提供されています。テキサス・インスツルメンツがこれらのリソースを提供することは、適用されるテキサス・インスツルメンツの保証または他の保証の放棄の拡大や変更を意味するものではありません。

お客様がいかなる追加条項または代替条項を提案した場合でも、テキサス・インスツルメンツはそれらに異議を唱え、拒否します。

郵送先住所：Texas Instruments, Post Office Box 655303, Dallas, Texas 75265
Copyright © 2025, Texas Instruments Incorporated