

SN74LV1T34 単一電源シングル・バッファ・ゲート CMOS ロジック・レベル・シフタ

1 特長

- JESD 17 準拠で 250mA 超のラッチアップ性能
- 5V、3.3V、2.5V、1.8V V_{CC} の単一電源電圧トランスレータ
- 動作範囲: 1.65V ~ 5.5V
- 昇圧変換:
 - 1.8V V_{CC} で 1.2V⁽¹⁾ から 1.8V
 - 2.5V V_{CC} で 1.5V⁽¹⁾ から 2.5V
 - 3.3V V_{CC} で 1.8V⁽¹⁾ から 3.3V
 - 5.0V V_{CC} で 3.3V から 5.0V
- 降圧変換:
 - 1.8V V_{CC} で 3.3V から 1.8V
 - 2.5V V_{CC} で 3.3V から 2.5V
 - 3.3V V_{CC} で 5.0V から 3.3V
- ロジック出力は V_{CC} を基準とする
- 出力駆動能力:
 - 5V で 8mA の出力駆動能力
 - 3.3V で 7mA の出力駆動能力
 - 1.8V で 3mA の出力駆動能力
- 3.3V の V_{CC} で最大 50MHz の動作を特性評価
- 入力ピンの許容電圧: 5V
- -40°C ~ 125°C の動作温度範囲

- 標準ロジックピン配置をサポート
- CMOS 出力 B は AUP1G および LVC1G ファミリと互換性あり。¹

2 アプリケーション

- テレコム
- 携帯用アプリケーション
- サーバー
- PC とノート PC

3 概要

SN74LV1T34 は、電圧レベル変換アプリケーションをサポートするために入力スレッショルドを低減した、シングルバッファゲートです。

パッケージ情報

部品番号	パッケージ ⁽¹⁾	パッケージ ⁽²⁾	本体サイズ ⁽³⁾
SN74LV1T34	DBV (SOT-23, 5)	2.90mm × 2.8mm	2.90mm × 1.60mm
	DCK (SC70, 5)	2.00mm × 2.1mm	2.00mm × 1.25mm

- (1) 詳細については、[セクション 12](#) を参照してください。
- (2) パッケージサイズ (長さ×幅) は公称値であり、該当する場合はピンも含まれます。
- (3) 本体サイズ (長さ×幅) は公称値であり、ピンは含まれません。

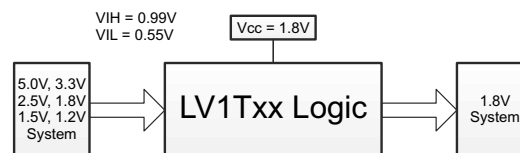
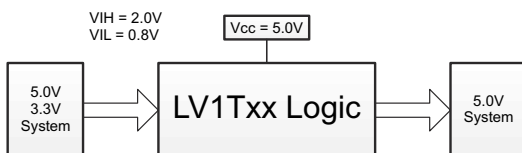

¹ より低い V_{CC} の条件については、 V_{IH}/V_{IL} と出力駆動能力を参照。



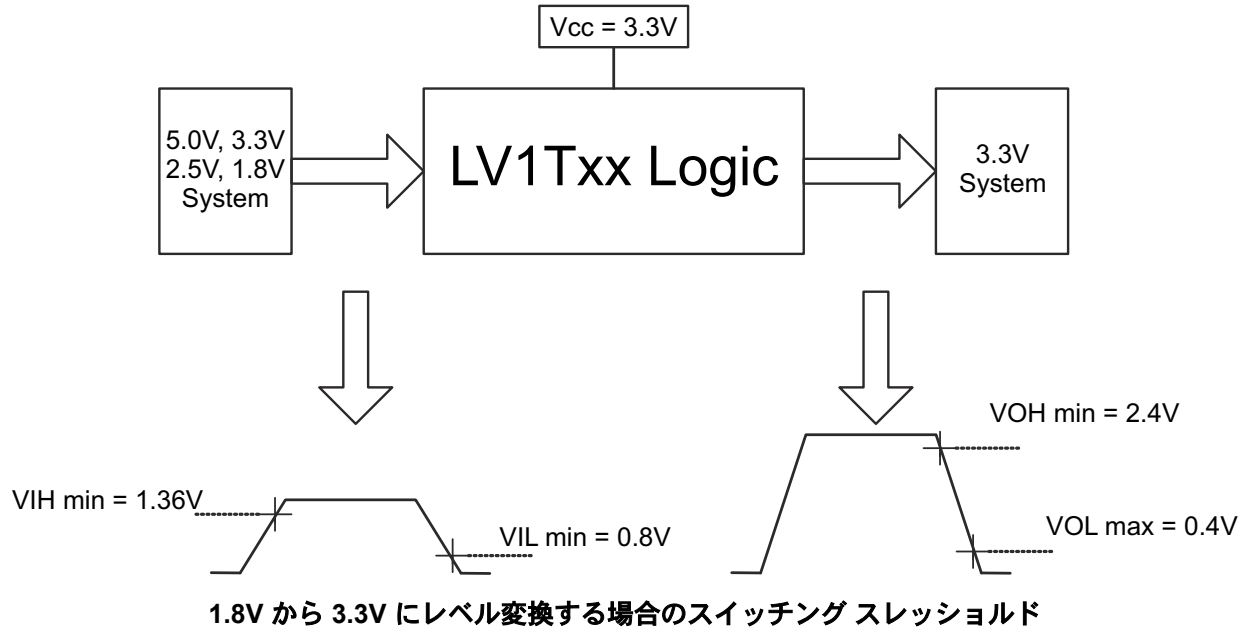

Table of Contents

1 特長	1	8.2 Functional Block Diagram.....	11
2 アプリケーション	1	8.3 Feature Description.....	11
3 概要	1	8.4 Device Functional Modes.....	13
4 Related Products	4	9 Application and Implementation	14
5 Pin Configuration and Functions	5	9.1 Power Supply Recommendations.....	14
6 Specifications	6	9.2 Layout.....	14
6.1 Absolute Maximum Ratings.....	6	10 Device and Documentation Support	15
6.2 ESD Ratings.....	6	10.1 Documentation Support (Analog).....	15
6.3 Recommended Operating Conditions.....	6	10.2 ドキュメントの更新通知を受け取る方法.....	15
6.4 Thermal Information.....	7	10.3 サポート・リソース.....	15
6.5 Electrical Characteristics.....	7	10.4 Trademarks.....	15
6.6 Switching Characteristics.....	8	10.5 静電気放電に関する注意事項.....	15
6.7 Operating Characteristics.....	8	10.6 用語集.....	15
6.8 Typical Characteristics.....	9	11 Revision History	15
7 Parameter Measurement Information	10	12 Mechanical, Packaging, and Orderable Information	16
8 Detailed Description	11		
8.1 Overview.....	11		

4 Related Products

DEVICE	PACKAGE	DESCRIPTION
SN74LV1T00	DCK, DBV	2-Input Positive-NAND Gate
SN74LV1T02	DCK, DBV	2-Input Positive-NOR Gate
SN74LV1T04	DCK, DBV	Inverter Gate
SN74LV1T08	DCK, DBV	2-Input Positive-AND Gate
SN74LV1T17	DCK, DBV	Single Schmitt-Trigger Buffer Gate
SN74LV1T14	DCK, DBV	Single Schmitt-Trigger Inverter Gate
SN74LV1T32	DCK, DBV	2-Input Positive-OR Gate
SN74LV1T34	DCK, DBV	Single Buffer Gate
SN74LV1T86	DCK, DBV	Single 2-Input Exclusive-Or Gate
SN74LV1T125	DCK, DBV	Single Buffer Gate with 3-state Output
SN74LV1T126	DCK, DBV	Single Buffer Gate with 3-state Output
SN74LV4T125	RGY, PW	Quadruple Bus Buffer Gate With 3-State Outputs

5 Pin Configuration and Functions



図 5-1. DCK or DBV Package, 5-Pin SC70 or SOT-23 (Top View)

表 5-1. Pin Functions

PIN		TYPE ⁽¹⁾	DESCRIPTION
NAME	NO.		
NC	1	—	Not internally connected
A	2	I	Input A
GND	3	G	Ground
Y	4	O	Output Y
V _{CC}	5	P	Positive supply

(1) I = Input, O = Output, I/O = Input or Output, G = Ground, P = Power.

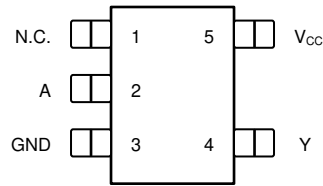
6 Specifications

6.1 Absolute Maximum Ratings

over operating free-air temperature range (unless otherwise noted)⁽¹⁾

		MIN	MAX	UNIT
V _{CC}	Supply voltage range	-0.5	7.0	V
V _I	Input voltage range ⁽²⁾	-0.5	7.0	V
V _O	Voltage range applied to any output in the high or low state ⁽²⁾	-0.5	V _{CC} + 0.5	V
I _{IK}	Input clamp current	V _I < 0		-20 mA
I _{OK}	Output clamp current	V _O < 0 or V _O > V _{CC}		±20 mA
I _O	Continuous output current			±25 mA
	Continuous current through V _{CC} or GND			±50 mA
T _J	Junction temperature			150 °C
T _{stg}	Storage temperature	-65	150	°C

- (1) Stresses beyond those listed under *Absolute Maximum Ratings* may cause permanent damage to the device. These are stress ratings only, and functional operation of the device at these or any other conditions beyond those indicated under *Recommended Operating Conditions* is not implied. Exposure to absolute-maximum-rated conditions for extended periods may affect device reliability.
- (2) The input negative-voltage and output voltage ratings may be exceeded if the input and output current ratings are observed.

6.2 ESD Ratings

		VALUE	UNIT
V _(ESD)	Electrostatic discharge	Human-body model (HBM), per ANSI/ESDA/JEDEC JS-001 ⁽¹⁾	±2000
		Machine Model (MM), per JEDEC specification	±200
		Charged-device model (CDM), per ANSI/ESDA/JEDEC JS-002 ⁽²⁾	±1000

- (1) JEDEC document JEP155 states that 500-V HBM allows safe manufacturing with a standard ESD control process.
- (2) JEDEC document JEP157 states that 250-V CDM allows safe manufacturing with a standard ESD control process.

6.3 Recommended Operating Conditions

over operating free-air temperature range (unless otherwise noted)⁽¹⁾

		MIN	MAX	UNIT
V _{CC}	Supply voltage	1.6	5.5	V
V _I	Input voltage	0	5.5	V
V _O	Output voltage	0	V _{CC}	V
I _{OH}	High-level output current	V _{CC} = 1.8 V	-3	mA
		V _{CC} = 2.5 V	-5	
		V _{CC} = 3.3 V	-7	
		V _{CC} = 5.0 V	-8	
I _{OL}	Low-level output current	V _{CC} = 1.8 V	3	mA
		V _{CC} = 2.5 V	5	
		V _{CC} = 3.3 V	7	
		V _{CC} = 5.0 V	8	
Δt/Δv	Input transition rise or fall rate	V _{CC} = 1.8 V	20	ns/V
		V _{CC} = 3.3 V or 2.5 V	20	
		V _{CC} = 5.0 V	20	
T _A	Operating free-air temperature	-40	125	°C

- (1) All unused inputs of the device must be held at V_{CC} or GND to ensure proper device operation. Refer to the TI application report, *Implications of Slow or Floating CMOS Inputs*, literature number [SCBA004](#).

6.4 Thermal Information

THERMAL METRIC ⁽¹⁾		DBV	DCK	UNIT
		5 PINS	5 PINS	
R _{θJA}	Junction-to-ambient thermal resistance	278	289.2	°C/W

(1) For more information about traditional and new thermal metrics, see the *IC Package Thermal Metrics* application report, [SPRA953](#).

6.5 Electrical Characteristics

over recommended operating free-air temperature range (unless otherwise noted)

PARAMETER	TEST CONDITIONS	V _{CC}	T _A = 25°C			T _A = –40°C to +125°C			UNIT
			MIN	TYP	MAX	MIN	TYP	MAX	
V _{IH}	High-level input voltage	V _{CC} = 1.65 V to 1.8 V	0.95			1			V
		V _{CC} = 2.0 V	0.99			1.03			
		V _{CC} = 2.25 V to 2.5 V	1.145			1.18			
		V _{CC} = 2.75 V	1.22			1.25			
		V _{CC} = 3 V to 3.3 V	1.37			1.39			
		V _{CC} = 3.6 V	1.47			1.48			
		V _{CC} = 4.5 V to 5.0 V	2.02			2.03			
V _{IL}	Low-level input voltage	V _{CC} = 1.65 V to 2.0 V				0.55			V
		V _{CC} = 2.25 V to 2.75 V				0.71			
		V _{CC} = 3 V to 3.6 V				0.65			
		V _{CC} = 4.5 V to 5.5 V				0.8			
V _{OH}	High-level output voltage	I _{OH} = –20 μA	1.65 V to 5.5 V	V _{CC} – 0.1		V _{CC} – 0.1			V
		I _{OH} = –2.0 mA	1.65 V	1.28		1.21			
			1.8 V	1.5		1.45			
		I _{OH} = –3.0 mA	2.3 V	2		1.93			
		I _{OH} = –3.0 mA	2.5 V	2.25		2.15			
			3.0 V	2.78		2.7			
		I _{OH} = –5.5 mA	3.3 V	2.6		2.49			
			4.5 V	2.9		2.8			
		I _{OH} = –8.0 mA	5.0 V	4.2		4.1			
	4.1		3.95						
V _{OL}	Low-level output voltage	I _{OL} = 20 μA	1.65 V to 5.5 V			0.1			V
		I _{OL} = 2.0 mA	1.65 V			0.25			
		I _{OL} = 3.0 mA	2.3 V			0.2			
			3.0 V			0.15			
		I _{OL} = 5.5 mA	4.5 V			0.252			
			4.0 mA			0.2			
		I _{OL} = 8.0 mA	5.0 V			0.35			
I _I	Input leakage current	A input; V _I = 0 V or V _{CC}	0 V, 1.8 V, 2.5 V, 3.3 V, 5.5 V			0.1			±1 μA
I _{CC}	Static supply current	V _I = 0 V or V _{CC} , I _O = 0; open on loading	5.0 V			1			μA
			3.3 V			1			
			2.5 V			1			
			1.8 V			1			

over recommended operating free-air temperature range (unless otherwise noted)

PARAMETER	TEST CONDITIONS	V _{CC}	T _A = 25°C			T _A = -40°C to +125°C			UNIT
			MIN	TYP	MAX	MIN	TYP	MAX	
ΔI _{CC}	Additional static supply current One input at 0.3 V or 3.4 V, Other inputs at 0 or V _{CC} , I _O = 0	5.5 V			1.35			1.5	mA
		1.8 V			10			10	μA
C _i	Input capacitance V _I = V _{CC} or GND	3.3 V		2	10		2	10	pF
C _o	Output capacitance V _O = V _{CC} or GND	3.3 V		2.5			2.5		pF

6.6 Switching Characteristics

over recommended operating free-air temperature range (unless otherwise noted) (see [Load Circuit and Voltage Waveforms](#))

PARAMETER	FROM (INPUT)	TO (OUTPUT)	FREQUENCY (TYP)	V _{CC}	C _L	T _A = 25°C			T _A = -65°C to 125°C			UNIT
						MIN	TYP	MAX	MIN	TYP	MAX	
t _{pd}	Any In	Y	DC to 50 MHz	5.0 V	15 pF	2.7	5.5	3.4	6.5	ns		
					30 pF	3	6.5	4.1	7.5			
				3.3 V	15 pF	4	7	5	8	ns		
					30 pF	4.9	8	6	9			
			DC to 25 MHz	2.5 V	15 pF	5.8	8.5	6.8	9.5	ns		
					30 pF	6.5	9.5	7.5	10.5			
			DC to 15 MHz	1.8 V	15 pF	10.5	13	11.8	14	ns		
					30 pF	12	14.5	12	15.5			

6.7 Operating Characteristics

T_A = 25°C

PARAMETER	TEST CONDITIONS	V _{CC}	TYP	UNIT
C _{pd}	Power dissipation capacitance f = 1 MHz and 10 MHz	1.8 V ± 0.15 V	14	pF
		2.5 V ± 0.2 V	14	
		3.3 V ± 0.3 V	14	
		5.5 V ± 0.5 V	14	

6.8 Typical Characteristics

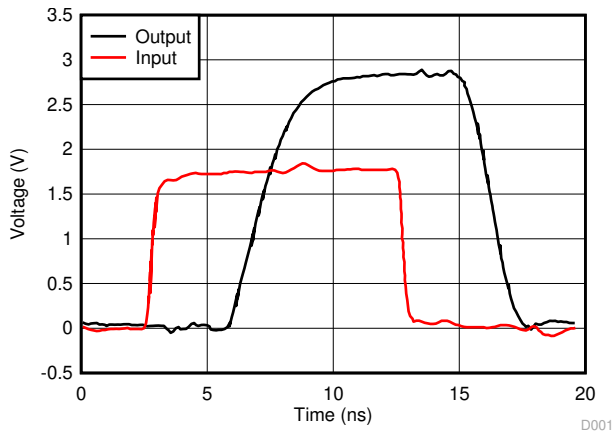

Figure 6-1. Switching Characteristics at 50 MHz Excellent Signal Integrity

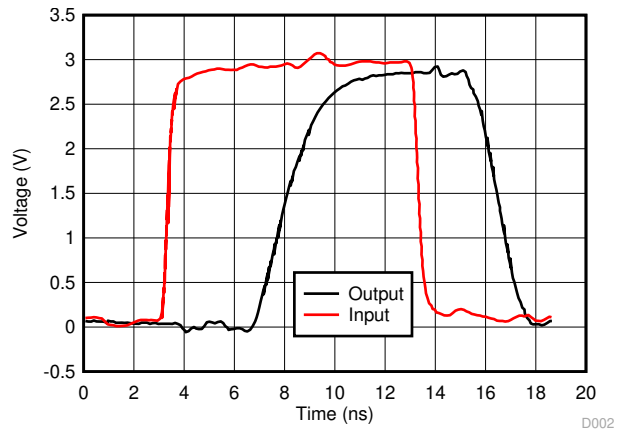

Figure 6-2. Switching Characteristics at 50 MHz Excellent Signal Integrity

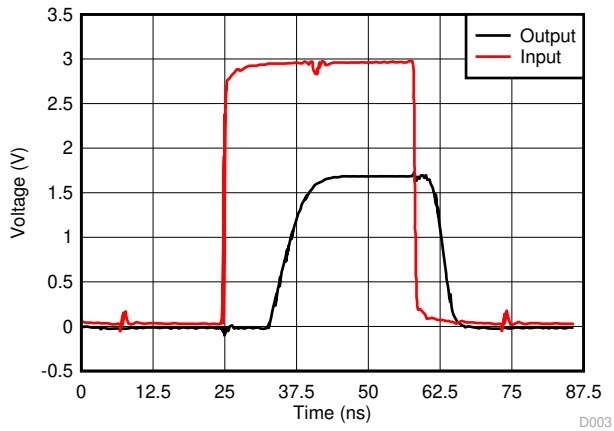
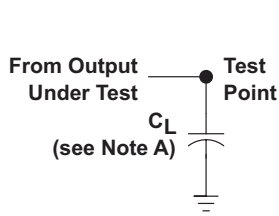
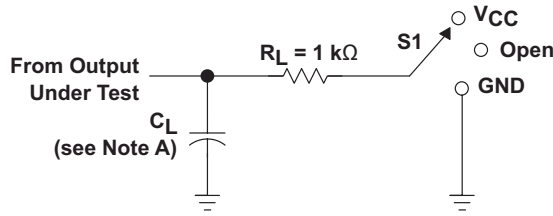

Figure 6-3. Switching Characteristics at 15 MHz Excellent Signal Integrity

7 Parameter Measurement Information



LOAD CIRCUIT FOR TOTEM-POLE OUTPUTS



LOAD CIRCUIT FOR 3-STATE AND OPEN-DRAIN OUTPUTS

TEST	S1
t_{PLH}/t_{PHL}	Open
t_{PLZ}/t_{PZL}	V_{CC}
t_{PHZ}/t_{PZH}	GND
Open Drain	V_{CC}

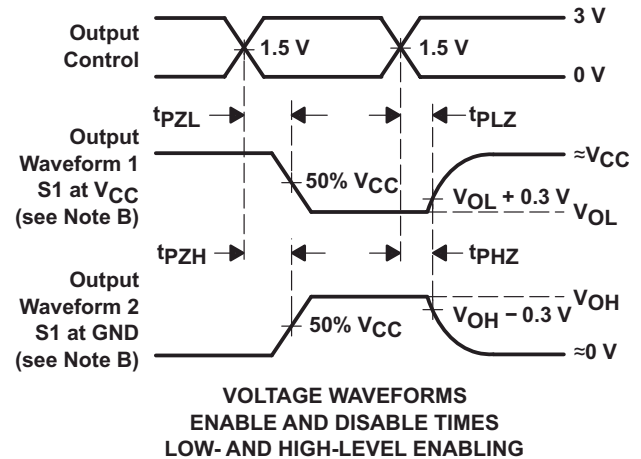
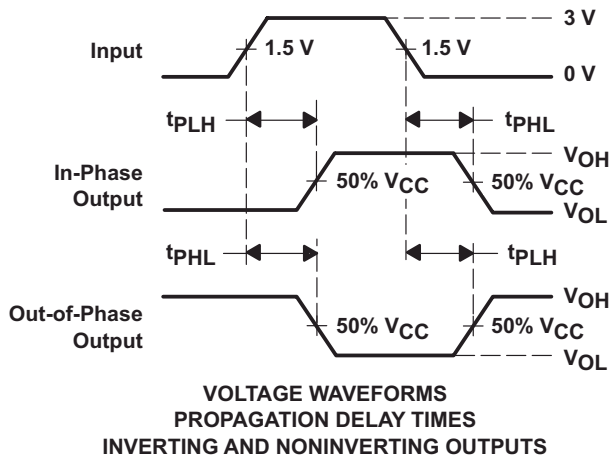
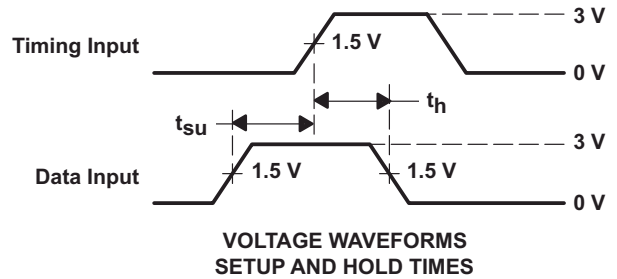
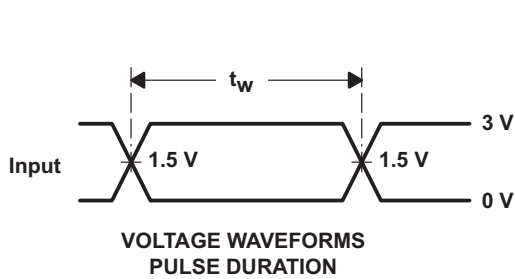

- NOTES: A. C_L includes probe and jig capacitance.
 B. Waveform 1 is for an output with internal conditions such that the output is low, except when disabled by the output control. Waveform 2 is for an output with internal conditions such that the output is high, except when disabled by the output control.
 C. All input pulses are supplied by generators having the following characteristics: $PRR \leq 1 \text{ MHz}$, $Z_O = 50 \Omega$, $t_r \leq 3 \text{ ns}$, $t_f \leq 3 \text{ ns}$.
 D. The outputs are measured one at a time, with one input transition per measurement.
 E. All parameters and waveforms are not applicable to all devices.

图 7-1. Load Circuit and Voltage Waveforms

8 Detailed Description

8.1 Overview

The SN74LV1T34 device is a low-voltage CMOS gate logic that operates at a wider voltage range for industrial, portable, telecom, and automotive applications. The output level is referenced to the supply voltage and is able to support 1.8-V, 2.5-V, 3.3-V, and 5-V CMOS levels. The input is designed with a lower threshold circuit to match 1.8 V input logic at $V_{CC} = 3.3$ V and can be used in 1.8 V to 3.3 V level-up translation. In addition, the 5 V tolerant input pins enable down translation (that is, 3.3 V to 2.5 V output at $V_{CC} = 2.5$ V). The wide V_{CC} range of 1.8 V to 5.5 V allows generation of desired output levels to connect to controllers or processors. The SN74LV1T34 device is designed with current-drive capability of 8 mA to reduce line reflections, overshoot, and undershoot caused by high-drive outputs.

8.2 Functional Block Diagram



図 8-1. Logic Diagram

8.3 Feature Description

8.3.1 Clamp Diode Structure

The outputs to this device have both positive and negative clamping diodes, and the inputs to this device have negative clamping diodes only as depicted in 図 8-2.

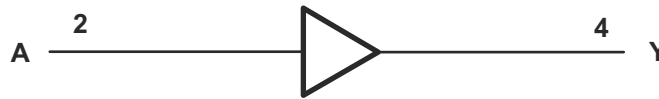
注意

Voltages beyond the values specified in the *Absolute Maximum Ratings* table can cause damage to the device. The input and output voltage ratings may be exceeded if the input and output clamp-current ratings are observed.



図 8-2. Electrical Placement of Clamping Diodes for Each Input and Output

8.3.2 Balanced CMOS Push-Pull Outputs

This device includes balanced CMOS push-pull outputs. The term *balanced* indicates that the device can sink and source similar currents. The drive capability of this device may create fast edges into light loads so routing and load conditions should be considered to prevent ringing. Additionally, the outputs of this device are capable of driving larger currents than the device can sustain without being damaged. It is important for the output power of the device to be limited to avoid damage due to overcurrent. The electrical and thermal limits defined in the *Absolute Maximum Ratings* must be followed at all times.

Unused push-pull CMOS outputs should be left disconnected.

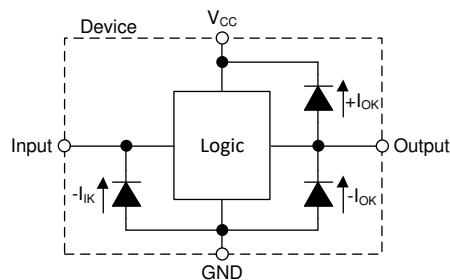
8.3.3 LVxT Enhanced Input Voltage

The SN74LV1T34 belongs to TI's LVxT family of Logic devices with integrated voltage level translation. This family of devices was designed with reduced input voltage thresholds to support up-translation, and inputs tolerant of signals with up to 5.5 V levels to support down-translation. The output voltage will always be referenced to the supply voltage (V_{CC}), as described in the *Electrical Characteristics* table. To ensure proper functionality, input signals must remain at or below the specified $V_{IH(MIN)}$ level for a HIGH input state, and at or below the specified $V_{IL(MAX)}$ for a LOW input state. [Figure 8-3](#) shows the typical V_{IH} and V_{IL} levels for the LVxT family of devices, as well as the voltage levels for standard CMOS devices for comparison.

The inputs are high impedance and are typically modeled as a resistor in parallel with the input capacitance given in the *Electrical Characteristics*. The worst case resistance is calculated with the maximum input voltage, given in the *Absolute Maximum Ratings*, and the maximum input leakage current, given in the *Electrical Characteristics*, using Ohm's law ($R = V \div I$).

The inputs require that input signals transition between valid logic states quickly, as defined by the input transition time or rate in the *Recommended Operating Conditions* table. Failing to meet this specification will result in excessive power consumption and could cause oscillations. More details can be found in the [Implications of Slow or Floating CMOS Inputs](#) application report.

Do not leave inputs floating at any time during operation. Unused inputs must be terminated at V_{CC} or GND. If a system will not be actively driving an input at all times, a pull-up or pull-down resistor can be added to provide a valid input voltage during these times. The resistor value will depend on multiple factors; however, a 10-k Ω resistor is recommended and will typically meet all requirements.

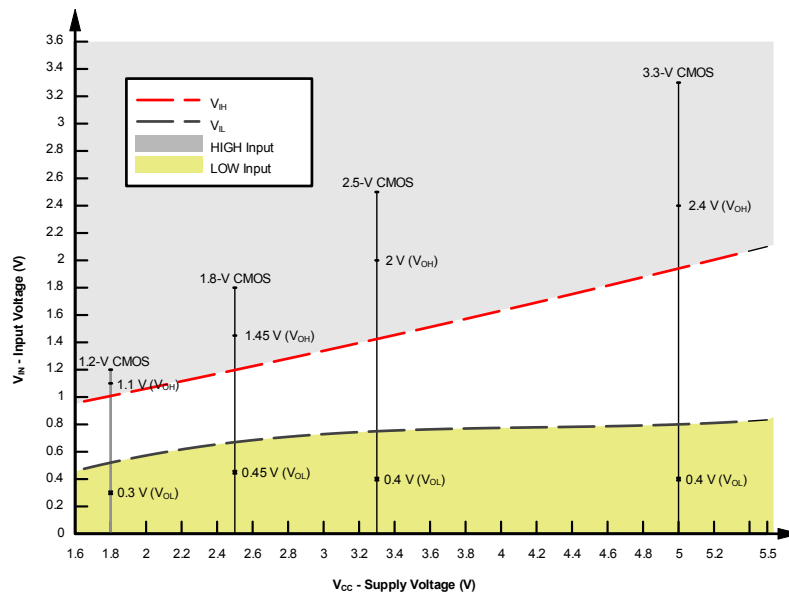

Figure 8-3. LVxT Input Voltage Levels

8.3.3.1 Down Translation

Signals can be translated down using the SN74LV1T34. The voltage applied at the V_{CC} will determine the output voltage and the input thresholds as described in the *Recommended Operating Conditions* and *Electrical Characteristics* tables.

When connected to a high-impedance input, the output voltage will be approximately V_{CC} in the HIGH state, and 0 V in the LOW state. Ensure that the input signals in the HIGH state are between $V_{IH(MIN)}$ and 5.5 V, and input signals in the LOW state are lower than $V_{IL(MAX)}$ as shown in [Figure 8-3](#).

For example, standard CMOS inputs for devices operating at 5.0 V, 3.3 V or 2.5 V can be down-translated to match 1.8 V CMOS signals when operating from 1.8-V V_{CC} . See [Figure 8-4](#).

Down Translation Combinations:

- 1.8-V V_{CC} – Inputs from 2.5 V, 3.3 V, and 5.0 V
- 2.5-V V_{CC} – Inputs from 3.3 V and 5.0 V
- 3.3-V V_{CC} – Inputs from 5.0 V

8.3.3.2 Up Translation

Input signals can be up translated using the SN74LV1T34. The voltage applied at V_{CC} will determine the output voltage and the input thresholds as described in the *Recommended Operating Conditions* and *Electrical Characteristics* tables. When connected to a high-impedance input, the output voltage will be approximately V_{CC} in the HIGH state, and 0 V in the LOW state.

The inputs have reduced thresholds that allow for input high-state levels which are much lower than standard values. For example, standard CMOS inputs for a device operating at a 5-V supply will have a $V_{IH(MIN)}$ of 3.5 V. For the SN74LV1T34, $V_{IH(MIN)}$ with a 5-V supply is only 2 V, which would allow for up-translation from a typical 2.5-V to 5-V signals.

Ensure that the input signals in the HIGH state are above $V_{IH(MIN)}$ and input signals in the LOW state are lower than $V_{IL(MAX)}$ as shown in [Figure 8-4](#).

Up Translation Combinations:

- 1.8-V V_{CC} – Inputs from 1.2 V
- 2.5-V V_{CC} – Inputs from 1.8 V
- 3.3-V V_{CC} – Inputs from 1.8 V and 2.5 V
- 5.0-V V_{CC} – Inputs from 2.5 V and 3.3 V

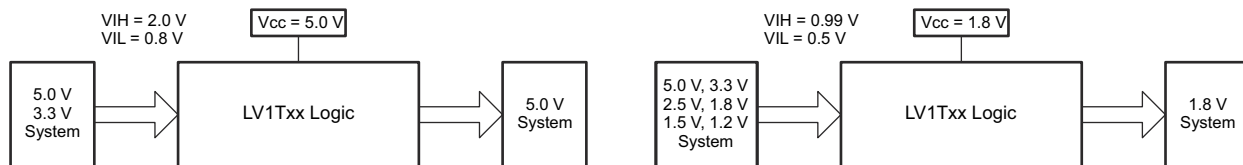

Figure 8-4. LVxT Up and Down Translation Example

8.4 Device Functional Modes

[Table 8-1](#) is the function table for the SN74LV1T34.

Table 8-1. Function Table

INPUT (LOWER LEVEL INPUT)	OUTPUT (V_{CC} CMOS)
A	Y
H	H
L	L

9 Application and Implementation

注

Information in the following applications sections is not part of the TI component specification, and TI does not warrant its accuracy or completeness. TI's customers are responsible for determining suitability of components for their purposes, as well as validating and testing their design implementation to confirm system functionality.

9.1 Power Supply Recommendations

The power supply can be any voltage between the minimum and maximum supply voltage rating located in the *Recommended Operating Conditions*. Each V_{CC} terminal should have a good bypass capacitor to prevent power disturbance. A 0.1- μ F capacitor is recommended for this device. It is acceptable to parallel multiple bypass caps to reject different frequencies of noise. The 0.1- μ F and 1- μ F capacitors are commonly used in parallel. The bypass capacitor should be installed as close to the power terminal as possible for best results, as shown in the following layout example.

9.2 Layout

9.2.1 Layout Guidelines

When using multiple-input and multiple-channel logic devices inputs must not ever be left floating. In many cases, functions or parts of functions of digital logic devices are unused; for example, when only two inputs of a triple-input AND gate are used or only 3 of the 4 buffer gates are used. Such unused input pins must not be left unconnected because the undefined voltages at the outside connections result in undefined operational states. All unused inputs of digital logic devices must be connected to a logic high or logic low voltage, as defined by the input voltage specifications, to prevent them from floating. The logic level that must be applied to any particular unused input depends on the function of the device. Generally, the inputs are tied to GND or V_{CC} , whichever makes more sense for the logic function or is more convenient.

10 Device and Documentation Support

10.1 Documentation Support (Analog)

10.1.1 Related Documentation

For related documentation, see the following:

- Texas Instruments, [CMOS Power Consumption and Cpd Calculation application note](#)
- Texas Instruments, [Designing With Logic application note](#)
- Texas Instruments, [Thermal Characteristics of Standard Linear and Logic \(SLL\) Packages and Devices application note](#)
- Texas Instruments, [Implications of Slow or Floating CMOS Inputs application note](#)

10.2 ドキュメントの更新通知を受け取る方法

ドキュメントの更新についての通知を受け取るには、www.tij.co.jp のデバイス製品フォルダを開いてください。[通知] をクリックして登録すると、変更されたすべての製品情報に関するダイジェストを毎週受け取ることができます。変更の詳細については、改訂されたドキュメントに含まれている改訂履歴をご覧ください。

10.3 サポート・リソース

テキサス・インスツルメンツ E2E™ サポート・フォーラムは、エンジニアが検証済みの回答と設計に関するヒントをエキスパートから迅速かつ直接得ることができる場所です。既存の回答を検索したり、独自の質問をしたりすることで、設計に必要な支援を迅速に得ることができます。

リンクされているコンテンツは、各寄稿者により「現状のまま」提供されるものです。これらはテキサス・インスツルメンツの仕様を構成するものではなく、必ずしもテキサス・インスツルメンツの見解を反映したものではありません。テキサス・インスツルメンツの[使用条件](#)を参照してください。

10.4 Trademarks

テキサス・インスツルメンツ E2E™ is a trademark of Texas Instruments.

すべての商標は、それぞれの所有者に帰属します。

10.5 静電気放電に関する注意事項



この IC は、ESD によって破損する可能性があります。テキサス・インスツルメンツは、IC を取り扱う際には常に適切な注意を払うことを推奨します。正しい取り扱いおよび設置手順に従わない場合、デバイスを破損するおそれがあります。

ESD による破損は、わずかな性能低下からデバイスの完全な故障まで多岐にわたります。精密な IC の場合、パラメータがわずかに変化するだけで公表されている仕様から外れる可能性があるため、破損が発生しやすくなっています。

10.6 用語集

[テキサス・インスツルメンツ用語集](#) この用語集には、用語や略語の一覧および定義が記載されています。

11 Revision History

資料番号末尾の英字は改訂を表しています。その改訂履歴は英語版に準じています。

Changes from Revision D (November 2023) to Revision E (February 2024) Page

- | | |
|---|---|
| • Updated RθJA values: DBV = 206 to 278, all values in °C/W | 7 |
|---|---|

Changes from Revision C (June 2017) to Revision D (November 2023) Page

- | | |
|--|----|
| • 「パッケージ情報」表にパッケージ サイズを追加 | 1 |
| • Added <i>Application and Implementation</i> section..... | 14 |

12 Mechanical, Packaging, and Orderable Information

The following pages include mechanical, packaging, and orderable information. This information is the most current data available for the designated devices. This data is subject to change without notice and revision of this document. For browser-based versions of this data sheet, refer to the left-hand navigation.

PACKAGING INFORMATION

Orderable Device	Status (1)	Package Type	Package Drawing	Pins	Package Qty	Eco Plan (2)	Lead finish/ Ball material (6)	MSL Peak Temp (3)	Op Temp (°C)	Device Marking (4/5)	Samples
SN74LV1T34DBVR	ACTIVE	SOT-23	DBV	5	3000	RoHS & Green	NIPDAU SN	Level-1-260C-UNLIM	-40 to 125	(3B3H, 3CJF, NEJ3, NEJJ, NEJS)	Samples
SN74LV1T34DBVRG4	ACTIVE	SOT-23	DBV	5	3000	RoHS & Green	NIPDAU	Level-1-260C-UNLIM	-40 to 125	NEJ3	Samples
SN74LV1T34DCKR	ACTIVE	SC70	DCK	5	3000	RoHS & Green	SN	Level-1-260C-UNLIM	-40 to 125	(1R4, WJ3, WJJ, WJS)	Samples
SN74LV1T34DCKRG4	ACTIVE	SC70	DCK	5	3000	RoHS & Green	NIPDAU	Level-1-260C-UNLIM		WJ3	Samples

(1) The marketing status values are defined as follows:

ACTIVE: Product device recommended for new designs.

LIFEBUY: TI has announced that the device will be discontinued, and a lifetime-buy period is in effect.

NRND: Not recommended for new designs. Device is in production to support existing customers, but TI does not recommend using this part in a new design.

PREVIEW: Device has been announced but is not in production. Samples may or may not be available.

OBSELETE: TI has discontinued the production of the device.

(2) **RoHS:** TI defines "RoHS" to mean semiconductor products that are compliant with the current EU RoHS requirements for all 10 RoHS substances, including the requirement that RoHS substance do not exceed 0.1% by weight in homogeneous materials. Where designed to be soldered at high temperatures, "RoHS" products are suitable for use in specified lead-free processes. TI may reference these types of products as "Pb-Free".

RoHS Exempt: TI defines "RoHS Exempt" to mean products that contain lead but are compliant with EU RoHS pursuant to a specific EU RoHS exemption.

Green: TI defines "Green" to mean the content of Chlorine (Cl) and Bromine (Br) based flame retardants meet JS709B low halogen requirements of <=1000ppm threshold. Antimony trioxide based flame retardants must also meet the <=1000ppm threshold requirement.

(3) MSL, Peak Temp. - The Moisture Sensitivity Level rating according to the JEDEC industry standard classifications, and peak solder temperature.

(4) There may be additional marking, which relates to the logo, the lot trace code information, or the environmental category on the device.

(5) Multiple Device Markings will be inside parentheses. Only one Device Marking contained in parentheses and separated by a "-" will appear on a device. If a line is indented then it is a continuation of the previous line and the two combined represent the entire Device Marking for that device.

(6) Lead finish/Ball material - Orderable Devices may have multiple material finish options. Finish options are separated by a vertical ruled line. Lead finish/Ball material values may wrap to two lines if the finish value exceeds the maximum column width.

Important Information and Disclaimer:The information provided on this page represents TI's knowledge and belief as of the date that it is provided. TI bases its knowledge and belief on information provided by third parties, and makes no representation or warranty as to the accuracy of such information. Efforts are underway to better integrate information from third parties. TI has taken and

continues to take reasonable steps to provide representative and accurate information but may not have conducted destructive testing or chemical analysis on incoming materials and chemicals. TI and TI suppliers consider certain information to be proprietary, and thus CAS numbers and other limited information may not be available for release.

In no event shall TI's liability arising out of such information exceed the total purchase price of the TI part(s) at issue in this document sold by TI to Customer on an annual basis.

OTHER QUALIFIED VERSIONS OF SN74LV1T34 :

- Automotive : [SN74LV1T34-Q1](#)

NOTE: Qualified Version Definitions:

- Automotive - Q100 devices qualified for high-reliability automotive applications targeting zero defects

TAPE AND REEL INFORMATION

QUADRANT ASSIGNMENTS FOR PIN 1 ORIENTATION IN TAPE

*All dimensions are nominal

Device	Package Type	Package Drawing	Pins	SPQ	Reel Diameter (mm)	Reel Width W1 (mm)	A0 (mm)	B0 (mm)	K0 (mm)	P1 (mm)	W (mm)	Pin1 Quadrant
SN74LV1T34DBVR	SOT-23	DBV	5	3000	178.0	9.0	3.3	3.2	1.4	4.0	8.0	Q3
SN74LV1T34DBVRG4	SOT-23	DBV	5	3000	178.0	9.2	3.3	3.23	1.55	4.0	8.0	Q3
SN74LV1T34DCKR	SC70	DCK	5	3000	180.0	8.4	2.3	2.5	1.2	4.0	8.0	Q3
SN74LV1T34DCKRG4	SC70	DCK	5	3000	178.0	9.2	2.4	2.4	1.22	4.0	8.0	Q3

TAPE AND REEL BOX DIMENSIONS



*All dimensions are nominal

Device	Package Type	Package Drawing	Pins	SPQ	Length (mm)	Width (mm)	Height (mm)
SN74LV1T34DBVR	SOT-23	DBV	5	3000	180.0	180.0	18.0
SN74LV1T34DBVRG4	SOT-23	DBV	5	3000	180.0	180.0	18.0
SN74LV1T34DCKR	SC70	DCK	5	3000	210.0	185.0	35.0
SN74LV1T34DCKRG4	SC70	DCK	5	3000	180.0	180.0	18.0

EXAMPLE BOARD LAYOUT

DBV0005A

SOT-23 - 1.45 mm max height

SMALL OUTLINE TRANSISTOR



LAND PATTERN EXAMPLE
EXPOSED METAL SHOWN
SCALE:15X



SOLDER MASK DETAILS

4214839/K 08/2024

NOTES: (continued)

- 6. Publication IPC-7351 may have alternate designs.
- 7. Solder mask tolerances between and around signal pads can vary based on board fabrication site.

EXAMPLE STENCIL DESIGN

DBV0005A

SOT-23 - 1.45 mm max height

SMALL OUTLINE TRANSISTOR



SOLDER PASTE EXAMPLE
BASED ON 0.125 mm THICK STENCIL
SCALE:15X

4214839/K 08/2024

NOTES: (continued)

8. Laser cutting apertures with trapezoidal walls and rounded corners may offer better paste release. IPC-7525 may have alternate design recommendations.
9. Board assembly site may have different recommendations for stencil design.

DCK0005A



PACKAGE OUTLINE

SOT - 1.1 max height

SMALL OUTLINE TRANSISTOR

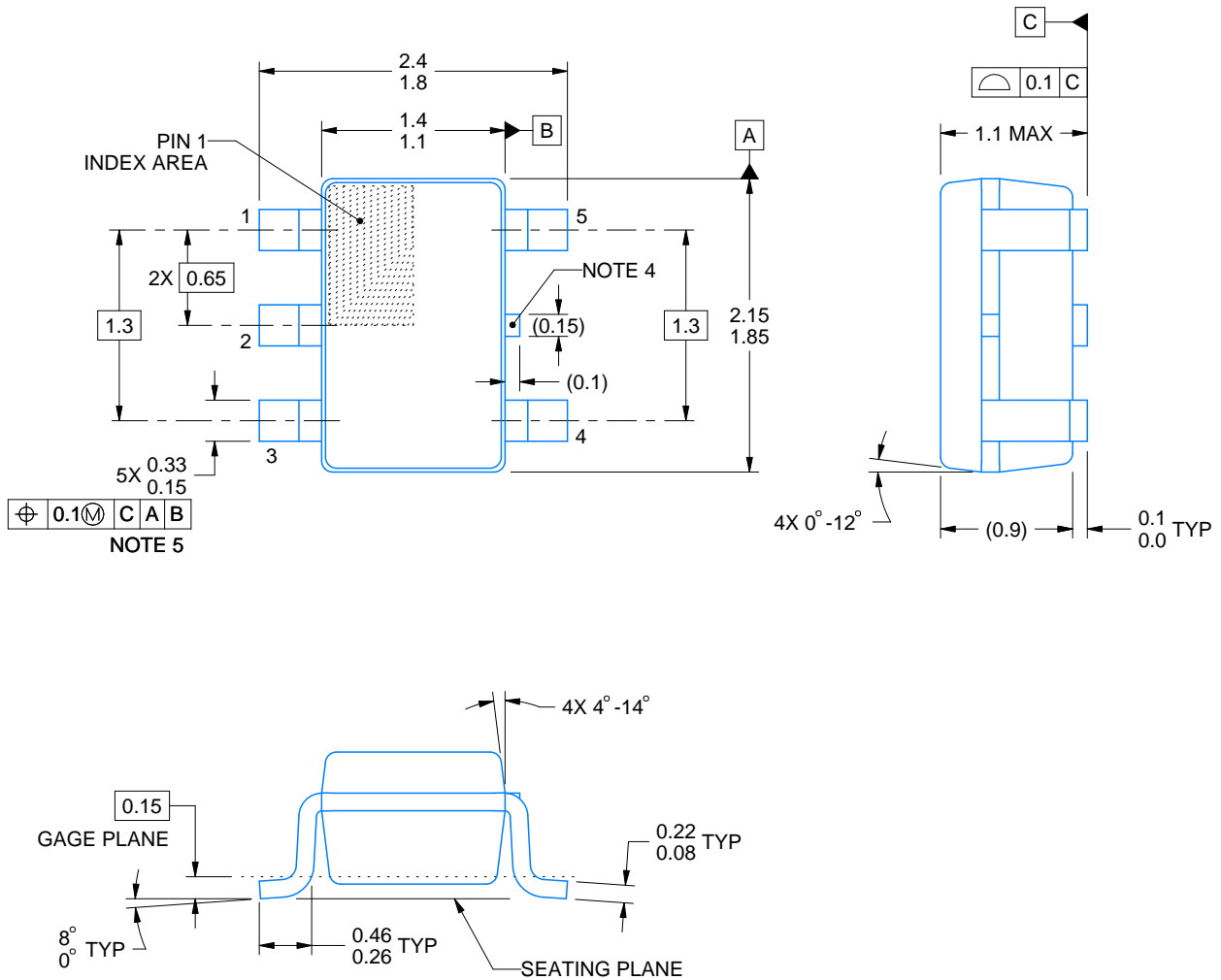

4214834/F 08/2024

NOTES:

1. All linear dimensions are in millimeters. Any dimensions in parenthesis are for reference only. Dimensioning and tolerancing per ASME Y14.5M.
2. This drawing is subject to change without notice.
3. Reference JEDEC MO-203.
4. Support pin may differ or may not be present.
5. Lead width does not comply with JEDEC.
6. Body dimensions do not include mold flash, protrusions, or gate burrs. Mold flash, protrusions, or gate burrs shall not exceed 0.25mm per side

EXAMPLE BOARD LAYOUT

DCK0005A

SOT - 1.1 max height

SMALL OUTLINE TRANSISTOR



LAND PATTERN EXAMPLE
EXPOSED METAL SHOWN
SCALE:18X

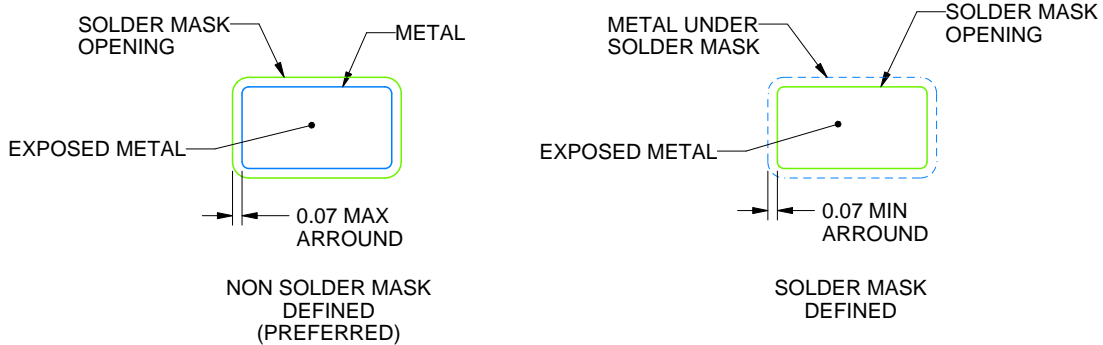

SOLDER MASK DETAILS

4214834/F 08/2024

NOTES: (continued)

- Publication IPC-7351 may have alternate designs.
- Solder mask tolerances between and around signal pads can vary based on board fabrication site.

EXAMPLE STENCIL DESIGN

DCK0005A

SOT - 1.1 max height

SMALL OUTLINE TRANSISTOR



SOLDER PASTE EXAMPLE
BASED ON 0.125 THICK STENCIL
SCALE: 18X

4214834/F 08/2024

NOTES: (continued)

9. Laser cutting apertures with trapezoidal walls and rounded corners may offer better paste release. IPC-7525 may have alternate design recommendations.
10. Board assembly site may have different recommendations for stencil design.

重要なお知らせと免責事項

TI は、技術データと信頼性データ(データシートを含みます)、設計リソース(リファレンス・デザインを含みます)、アプリケーションや設計に関する各種アドバイス、Web ツール、安全性情報、その他のリソースを、欠陥が存在する可能性のある「現状のまま」提供しており、商品性および特定目的に対する適合性の黙示保証、第三者の知的財産権の非侵害保証を含むいかなる保証も、明示的または黙示的にかかわらず拒否します。

これらのリソースは、TI 製品を使用する設計の経験を積んだ開発者への提供を意図したものです。(1) お客様のアプリケーションに適した TI 製品の選定、(2) お客様のアプリケーションの設計、検証、試験、(3) お客様のアプリケーションに該当する各種規格や、その他のあらゆる安全性、セキュリティ、規制、または他の要件への確実な適合に関する責任を、お客様のみが単独で負うものとし、

上記の各種リソースは、予告なく変更される可能性があります。これらのリソースは、リソースで説明されている TI 製品を使用するアプリケーションの開発の目的でのみ、TI はその使用をお客様に許諾します。これらのリソースに関して、他の目的で複製することや掲載することは禁止されています。TI や第三者の知的財産権のライセンスが付与されている訳ではありません。お客様は、これらのリソースを自身で使用した結果発生するあらゆる申し立て、損害、費用、損失、責任について、TI およびその代理人を完全に補償するものとし、TI は一切の責任を拒否します。

TI の製品は、[TI の販売条件](#)、または [ti.com](#) やかかる TI 製品の関連資料などのいずれかを通じて提供する適用可能な条項の下で提供されています。TI がこれらのリソースを提供することは、適用される TI の保証または他の保証の放棄の拡大や変更を意味するものではありません。

お客様がいかなる追加条項または代替条項を提案した場合でも、TI はそれらに異議を唱え、拒否します。

郵送先住所 : Texas Instruments, Post Office Box 655303, Dallas, Texas 75265
Copyright © 2024, Texas Instruments Incorporated