

SNx4LVC08A クワッド、2 入力、正論理 AND ゲート

1 特長

- JESD 17 準拠
250mA 超のラッチアップ性能
- JESD 22 を上回る ESD 保護
 - 2000V、人体モデル (A114-A)
 - 1000V、デバイス帯電モデル (C101)
 - MIL-PRF-38535 準拠の製品については、特に記述のない限り、すべてのパラメータはテスト済みです。その他のすべての製品については、量産プロセスにすべてのパラメータのテストが含まれているとは限りません。
- SN74LVC08A は、1.65V ~ 3.6V の電源電圧で動作します
- SN54LVC08A は、2.0V ~ 3.6V の電源電圧で動作します
- SNx4LVC08A は -40°C ~ +85°C と -40°C ~ +125°C で動作を規定
- SN54LVC08A は -55°C ~ +125°C で動作を規定
- 5.5V までの入力電圧に対応
- 最大 t_{pd} 4.1ns (3.3V 時)
- V_{OLP} 標準値 (出力グランド バウンス)
$0.8V (V_{CC} = 3.3V, T_A = 25^\circ C)$
- V_{OHV} 標準値 (出力 V_{OH} アンダーシュート)
>2V ($V_{CC} = 3.3V, T_A = 25^\circ C$)

2 アプリケーション

- サーバー
- LED ディスプレイ
- ネットワーク スイッチ
- I/O エクスパンダ
- ベースステーション プロセッサ ボード

3 概要

SN54LVC08A クワッド 2 入力正論理 AND ゲートは 2.7V ~ 3.6V の V_{CC} で動作するように設計されており、SN74LVC08A クワッド 2 入力正論理 AND ゲートは 1.65V ~ 3.6V の V_{CC} で動作するように設計されています。

SNx4LVC08A デバイスはブール関数 $Y = A \cdot B$ or $Y = \overline{A + B}$ を正論理で実行します。

入力は 3.3V または 5V のデバイスから駆動できます。この機能により、3.3V と 5V が混在するシステム環境での変換装置としてこのデバイスを使用できます。

製品情報

部品番号	パッケージ (1)	パッケージ サイズ (2)	本体サイズ (3)
SNx4LVC08A	BQA (WQFN, 14)	3mm × 2.5mm	3mm × 2.5mm
	D (SOIC, 14)	8.65mm × 6mm	8.65mm × 3.91mm
	DB (SSOP, 14)	6.2mm × 7.8mm	6.20mm × 5.30mm
	NS (SOP, 14)	10.2mm × 7.8mm	10.30mm × 5.30mm
	PW (TSSOP, 14)	5mm × 4.4mm	5.00mm × 4.40mm
	RGY (VQFN, 14)	3.5mm × 3.5mm	3.50mm × 3.50mm
	FK (LCCC, 20)	8.9mm × 8.9mm	8.89mm × 8.89mm
	J (CDIP, 14)	19.55mm × 7.9mm	19.55mm × 6.7mm
	W (CFP, 14)	9.21mm × 9mm	9.21mm × 6.28mm

- (1) 詳細については、[セクション 11](#) を参照してください。
- (2) パッケージ サイズ (長さ × 幅) は公称値であり、該当する場合はピンも含まれます。
- (3) 本体サイズ (長さ × 幅) は公称値であり、ピンは含まれません。



各ゲートの論理図
(正論理)



Table of Contents

1 特長	1	7 Detailed Description	11
2 アプリケーション	1	7.1 Overview.....	11
3 概要	1	7.2 Functional Block Diagram.....	11
4 Pin Configuration and Functions	3	7.3 Feature Description.....	11
5 Specifications	5	7.4 Device Functional Modes.....	12
5.1 Absolute Maximum Ratings.....	5	8 Application and Implementation	13
5.2 ESD Ratings.....	5	8.1 Application Information.....	13
5.3 Recommended Operating Conditions, SN54LVC08A.....	5	8.2 Typical Application.....	13
5.4 Recommended Operating Conditions, SN74LVC08A.....	6	8.3 Layout.....	14
5.5 Thermal Information.....	6	9 Device and Documentation Support	16
5.6 Electrical Characteristics, SN54LVC08A.....	7	9.1 Documentation Support (Analog).....	16
5.7 Electrical Characteristics, SN74LVC08A.....	7	9.2 Receiving Notification of Documentation Updates... 16	
5.8 Switching Characteristics, SN54LVC08A.....	8	9.3 サポート・リソース.....	16
5.9 Switching Characteristics, SN74LVC08A.....	8	9.4 Trademarks.....	16
5.10 Operating Characteristics.....	8	9.5 静電気放電に関する注意事項.....	16
5.11 Typical Characteristics.....	9	9.6 用語集.....	16
6 Parameter Measurement Information	10	11 Mechanical, Packaging, and Orderable Information	17

4 Pin Configuration and Functions



図 4-1. D, DB, NS, J, W, or PW Package 14-Pin SOIC, SSOP, SOP, CDIP, or TSSOP (Top View)



図 4-2. BQA or RGY Package 14-Pin WQFN or VQFN (Top View)

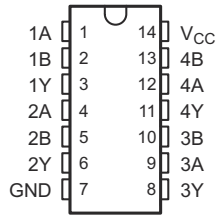

図 4-3. FK Package 20-Pin LCCC (Top View)

表 4-1. Pin Functions

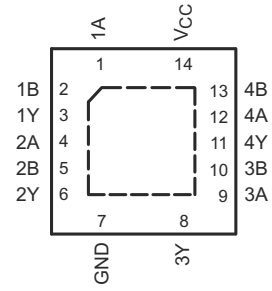
NAME	PIN		TYPE	DESCRIPTION
	SOIC, SSOP, SOP, CDIP, TSSOP, VQFN,WQFN	LCCC		
1A	1	2	I	Channel 1 input A
1B	2	3	I	Channel 1 input B
1Y	3	4	O	Channel 1 output
2A	4	6	I	Channel 2 input A
2B	5	8	I	Channel 2 input B
2Y	6	9	O	Channel 2 output
GND	7	10	Ground	Ground
3Y	8	12	O	Channel 3 output
3A	9	13	I	Channel 3 input A
3B	10	14	I	Channel 3 input B
4Y	11	16	O	Channel 4 output
4A	12	18	I	Channel 4 input A
4B	13	19	I	Channel 4 input B
V _{CC}	14	20	Power	Positive supply
Thermal Information ⁽¹⁾			—	The thermal pad can be connected to GND or left floating. Do not connect to any other signal or supply.
NC ⁽²⁾	—	1	—	No connect
		5		
		7		
		11		
		15		
		17		

(1) For BQA package only.

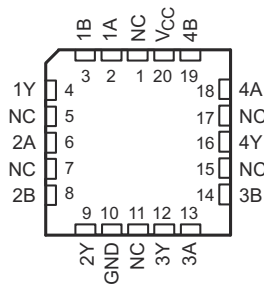
(2) NC – No internal connection

5 Specifications

5.1 Absolute Maximum Ratings

over operating free-air temperature range (unless otherwise noted)⁽¹⁾

		MIN	MAX	UNIT	
V _{CC}	Supply voltage	-0.5	6.5	V	
V _I	Input voltage ⁽²⁾	-0.5	6.5	V	
V _O	Output voltage ^{(2) (3)}	-0.5	V _{CC} + 0.5	V	
I _{IK}	Input clamp current	V _I < 0		-50	mA
I _{OK}	Output clamp current	V _O < 0		-50	mA
I _O	Continuous output current			±50	mA
	Continuous current through V _{CC} or GND			±100	mA
P _{tot}	Power dissipation ^{(4) (5)}	T _A = -40°C to +125°C		500	mW
T _J	Junction temperature	-65	150	°C	
T _{stg}	Storage temperature	-65	150	°C	

- (1) Stresses beyond those listed under *Absolute Maximum Ratings* may cause permanent damage to the device. These are stress ratings only, and functional operation of the device at these or any other conditions beyond those indicated under *Recommended Operating Conditions* is not implied. Exposure to absolute-maximum-rated conditions for extended periods may affect device reliability.
- (2) The input and output negative-voltage ratings may be exceeded if the input and output current ratings are observed.
- (3) The value of V_{CC} is provided in the *Recommended Operating Conditions* table.
- (4) For the D package: above 70°C, the value of P_{tot} derates linearly with 8 mW/K.
- (5) For the DB, NS, and PW packages: above 60°C, the value of P_{tot} derates linearly with 5.5 mW/K.

5.2 ESD Ratings

		VALUE	UNIT
V _(ESD)	Electrostatic discharge	Human body model (HBM), per ANSI/ESDA/JEDEC JS-001 ⁽¹⁾	±2000
		Charged-device model (CDM), per JEDEC specification JESD22-C101 ⁽²⁾	±1000
		Machine Model (MM) A115-A	200

- (1) JEDEC document JEP155 states that 500-V HBM allows safe manufacturing with a standard ESD control process.
- (2) JEDEC document JEP157 states that 250-V CDM allows safe manufacturing with a standard ESD control process.

5.3 Recommended Operating Conditions, SN54LVC08A

over operating free-air temperature range (unless otherwise noted)⁽¹⁾

		SN54LVC08A		UNIT		
		-55°C to +125°C				
		MIN	MAX			
V _{CC}	Supply voltage	Operating	2	3.6		
		Data retention only	1.5			
V _{IH}	High-level input voltage	V _{CC} = 2.7V to 3.6V		2	V	
V _{IL}	Low-level input voltage	V _{CC} = 2.7V to 3.6V			0.8	V
V _I	Input voltage	0	5.5		V	
V _O	Output voltage	0	V _{CC}		V	
I _{OH}	High-level output current	V _{CC} = 2.7V			-12	mA
		V _{CC} = 3V			-24	
I _{OL}	Low-level output current	V _{CC} = 2.7V			12	mA
		V _{CC} = 3V			24	
Δt/Δv	Input transition rise or fall rate			8	ns/V	

- (1) All unused inputs of the device must be held at V_{CC} or GND to ensure proper device operation. See [Implications of Slow or Floating CMOS Inputs](#), SCBA004.

5.4 Recommended Operating Conditions, SN74LVC08A

over operating free-air temperature range (unless otherwise noted)⁽¹⁾

		SN74LVC08A						UNIT		
		T _A = 25°C		–40°C to +85°C		–40°C to +125°C				
		MIN	MAX	MIN	MAX	MIN	MAX			
V _{CC}	Supply voltage	Operating		1.65	3.6	1.65	3.6	1.65	3.6	V
		Data retention only		1.5		1.5		1.5		
V _{IH}	High-level input voltage	V _{CC} = 1.65V to 1.95V		0.65 × V _{CC}		0.65 × V _{CC}		0.65 × V _{CC}		V
		V _{CC} = 2.3V to 2.7V		1.7		1.7		1.7		
		V _{CC} = 2.7V to 3.6V		2		2		2		
V _{IL}	Low-level input voltage	V _{CC} = 1.65V to 1.95V		0.35 × V _{CC}		0.35 × V _{CC}		0.35 × V _{CC}		V
		V _{CC} = 2.3V to 2.7V		0.7		0.7		0.7		
		V _{CC} = 2.7V to 3.6V		0.8		0.8		0.8		
V _I	Input voltage	0	5.5	0	5.5	0	5.5	0	5.5	V
V _O	Output voltage	0	V _{CC}	0	V _{CC}	0	V _{CC}	0	V _{CC}	V
I _{OH}	High-level output current	V _{CC} = 1.65V		–4		–4		–4		mA
		V _{CC} = 2.3V		–8		–8		–8		
		V _{CC} = 2.7 V		–12		–12		–12		
		V _{CC} = 3V		–24		–24		–24		
I _{OL}	Low-level output current	V _{CC} = 1.65V		4		4		4		mA
		V _{CC} = 2.3V		8		8		8		
		V _{CC} = 2.7V		12		12		12		
		V _{CC} = 3V		24		24		24		
Δt/Δv	Input transition rise or fall rate		8		8		8		8	ns/V

(1) All unused inputs of the device must be held at V_{CC} or GND to ensure proper device operation. See [Implications of Slow or Floating CMOS Inputs](#), SCBA004.

5.5 Thermal Information

THERMAL METRIC ⁽¹⁾		SN74LVC08A						UNIT
		BQA (WQFN)	D (SOIC)	DB (SSOP)	NS (SO)	PW (TSSOP)	RGY (LCCC)	
		14 PINS	14 PINS	14 PINS	14 PINS	14 PINS	14 PINS	
R _{θJA}	Junction-to-ambient thermal resistance	102.3	127.8	140.4	123.8	150.8	92.1	°C/W
R _{θJC(top)}	Junction-to-case (top) thermal resistance	96.8	81.9	65.3	52.7	56.0	56.6	°C/W
R _{θJB}	Junction-to-board thermal resistance	70.9	84.4	60.2	53.9	69.5	27.5	°C/W
ψ _{JT}	Junction-to-top characterization parameter	16.6	39.6	25.3	17.9	8.9	4.5	°C/W
ψ _{JB}	Junction-to-board characterization parameter	70.9	83.9	59.6	53.6	68.9	27.7	°C/W
R _{θJC(bot)}	Junction-to-case (bottom) thermal resistance	50.1	N/A	N/A	N/A	N/A	19.1	°C/W

(1) For more information about traditional and new thermal metrics, see the [Semiconductor and IC Package Thermal Metrics](#) application report.

5.6 Electrical Characteristics, SN54LVC08A

over recommended operating free-air temperature range (unless otherwise noted)

PARAMETER	TEST CONDITIONS	V _{CC}	SN54LVC08A			UNIT
			–55°C to +125°C			
			MIN	TYP ⁽¹⁾	MAX	
V _{OH}	I _{OH} = –100 μA	2.7V to 3.6V	V _{CC} – 0.2			V
	I _{OH} = –12 mA	2.7V	2.2			
		3V	2.4			
V _{OL}	I _{OL} = 100 μA	2.7V to 3.6V	0.2			V
	I _{OL} = 12 mA	2.7V	0.4			
	I _{OL} = 24 mA	3V	0.55			
I _I	V _I = 5.5 V or GND	3.6V	±5			μA
I _{CC}	V _I = V _{CC} or GND, I _O = 0	3.6V	10			μA
ΔI _{CC}	One input at V _{CC} – 0.6 V, Other inputs at V _{CC} or GND	2.7V to 3.6V	500			μA
C _i	V _I = V _{CC} or GND	3.3V	5			pF

(1) T_A = 25°C

5.7 Electrical Characteristics, SN74LVC08A

over recommended operating free-air temperature range (unless otherwise noted)

PARAMETER	TEST CONDITIONS	V _{CC}	SN74LVC08A						UNIT	
			T _A = 25°C			–40°C to +85°C		–40°C to +125°C		
			MIN	TYP	MAX	MIN	MAX	MIN		MAX
V _{OH}	I _{OH} = –100 μA	1.65V to 3.6V	V _{CC} – 0.2			V _{CC} – 0.2		V _{CC} – 0.3		V
	I _{OH} = –4 mA	1.65V	1.29			1.2		1.05		
		2.3V	1.9			1.7		1.55		
	I _{OH} = –12 mA	2.7V	2.2			2.2		2.05		
		3V	2.4			2.4		2.25		
I _{OH} = –24 mA	3V	2.3			2.2		2			
V _{OL}	I _{OL} = 100 μA	1.65V to 3.6V	0.1			0.2		0.3		V
	I _{OL} = 4 mA	1.65V	0.24			0.45		0.6		
		2.3V	0.3			0.7		0.75		
	I _{OL} = 12 mA	2.7V	0.4			0.4		0.6		
		3V	0.55			0.55		0.8		
I _{OL} = 24 mA	3V	0.55			0.55		0.8			
I _I	V _I = 5.5 V or GND	3.6V	±1			±5		±20		μA
I _{CC}	V _I = V _{CC} or GND, I _O = 0	3.6V	1			10		40		μA
ΔI _{CC}	One input at V _{CC} – 0.6 V, Other inputs at V _{CC} or GND	2.7V to 3.6V	500			500		5000		μA
C _i	V _I = V _{CC} or GND	3.3V	5							pF

5.8 Switching Characteristics, SN54LVC08A

over recommended operating free-air temperature range (unless otherwise noted) (see [Load Circuit and Voltage Waveforms](#))

PARAMETER	FROM (INPUT)	TO (OUTPUT)	V _{CC}	SN54LVC08A		UNIT
				–55°C to +125°C		
				MIN	MAX	
t _{pd}	A or B	Y	2.7V	4.8		ns
			3.3V ± 0.3V	1	4.1	

5.9 Switching Characteristics, SN74LVC08A

over recommended operating free-air temperature range (unless otherwise noted) (see [Load Circuit and Voltage Waveforms](#))

PARAMETER	FROM (INPUT)	TO (OUTPUT)	V _{CC}	SN74LVC08A						UNIT	
				T _A = 25°C			–40°C to +85°C		–40°C to +125°C		
				MIN	TYP	MAX	MIN	MAX	MIN		MAX
t _{pd}	A or B	Y	1.8V ± 0.15V	1	5	9.3	1	9.8	1	11.3	ns
			2.5V ± 0.2V	1	2.9	6.4	1	6.9	1	9	
			2.7V	1	3	4.6	1	4.8	1	6	
			3.3V ± 0.3V	1	2.6	3.9	1	4.1	1	5.5	
t _{sk(o)}			3.3V ± 0.3V					1		1.5	ns

5.10 Operating Characteristics

T_A = 25°C

PARAMETER		TEST CONDITIONS	V _{CC}	TYP	UNIT
C _{pd}	Power dissipation capacitance per gate	f = 10 MHz	1.8 V	7	pF
			2.5 V	9.8	
			3.3 V	10	

5.11 Typical Characteristics

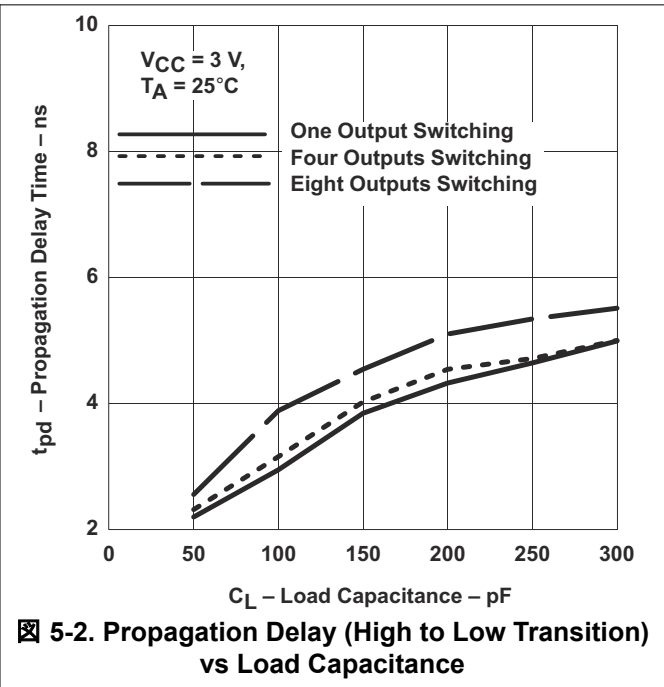
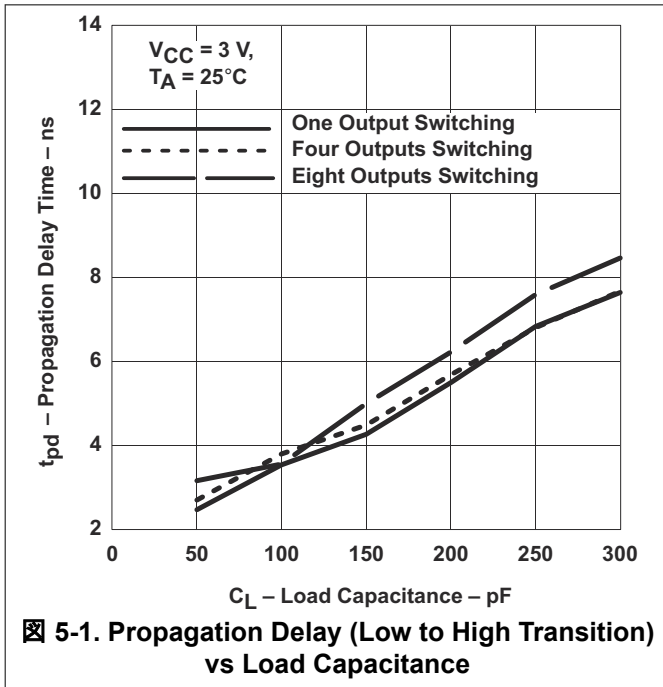

6 Parameter Measurement Information

Load Circuit and Voltage Waveforms

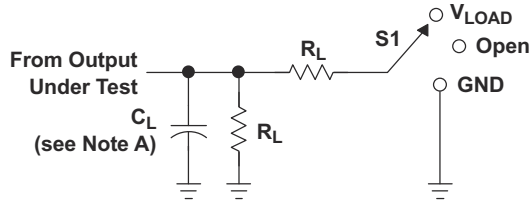

LOAD CIRCUIT

TEST	S1
t_{PLH}/t_{PHL}	Open
t_{PLZ}/t_{PZL}	V_{LOAD}
t_{PHZ}/t_{PZH}	GND

V_{CC}	INPUTS		V_M	V_{LOAD}	C_L	R_L	V_D
	V_I	t_r/t_f					
$1.8\text{ V} \pm 0.15\text{ V}$	V_{CC}	$\leq 2\text{ ns}$	$V_{CC}/2$	$2 \times V_{CC}$	30 pF	1 k Ω	0.15 V
$2.5\text{ V} \pm 0.2\text{ V}$	V_{CC}	$\leq 2\text{ ns}$	$V_{CC}/2$	$2 \times V_{CC}$	30 pF	500 Ω	0.15 V
2.7 V	2.7 V	$\leq 2.5\text{ ns}$	1.5 V	6 V	50 pF	500 Ω	0.3 V
$3.3\text{ V} \pm 0.3\text{ V}$	2.7 V	$\leq 2.5\text{ ns}$	1.5 V	6 V	50 pF	500 Ω	0.3 V

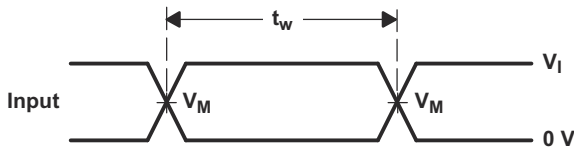

VOLTAGE WAVEFORMS
PULSE DURATION

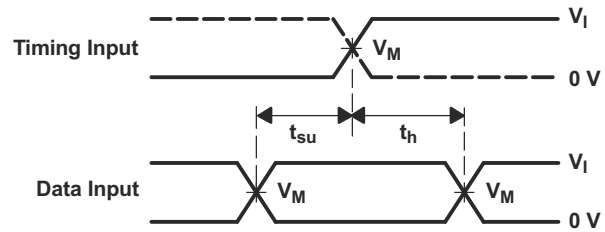

VOLTAGE WAVEFORMS
SETUP AND HOLD TIMES

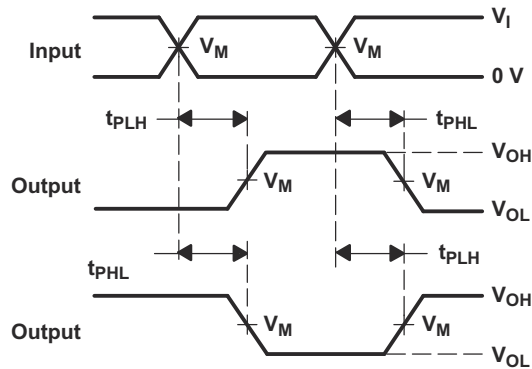

VOLTAGE WAVEFORMS
PROPAGATION DELAY TIMES
INVERTING AND NONINVERTING OUTPUTS

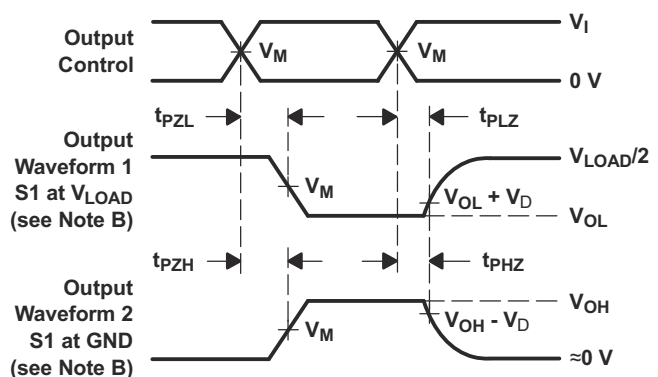

VOLTAGE WAVEFORMS
ENABLE AND DISABLE TIMES
LOW- AND HIGH-LEVEL ENABLING

- NOTES:
- A. C_L includes probe and jig capacitance.
 - B. Waveform 1 is for an output with internal conditions such that the output is low except when disabled by the output control. Waveform 2 is for an output with internal conditions such that the output is high, except when disabled by the output control.
 - C. All input pulses are supplied by generators having the following characteristics: $PRR \leq 10\text{ MHz}$, $Z_O = 50\text{ W}$.
 - D. The outputs are measured one at a time, with one transition per measurement.
 - E. t_{PLZ} and t_{PHZ} are the same as t_{dis} .
 - F. t_{PZL} and t_{PZH} are the same as t_{en} .
 - G. t_{PLH} and t_{PHL} are the same as t_{pd} .
 - H. All parameters and waveforms are not applicable to all devices.

7 Detailed Description

7.1 Overview

The SN74LVC08 device contains four 2-input positive AND gate device and performs the Boolean function $Y = A \times B$. This device is useful when multiple AND function is used in the system.

7.2 Functional Block Diagram



図 7-1. Logic Diagram, Each Gate (Positive Logic)

7.3 Feature Description

7.3.1 Balanced High-Drive CMOS Push-Pull Outputs

A balanced output allows the device to sink and source similar currents. The high drive capability of this device creates fast edges into light loads so routing and load conditions should be considered to prevent ringing. Additionally, the outputs of this device are capable of driving larger currents than the device can sustain without being damaged. It is important for the power output of the device to be limited to avoid thermal runaway and damage due to over-current. The electrical and thermal limits defined in the [セクション 5.1](#) must be followed at all times.

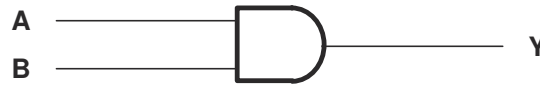
7.3.2 Standard CMOS Inputs

Standard CMOS inputs are high impedance and are typically modelled as a resistor in parallel with the input capacitance given in the [セクション 5.6](#) and [セクション 5.7](#). The worst case resistance is calculated with the maximum input voltage, given in the [セクション 5.1](#), and the maximum input leakage current, given in the [セクション 5.6](#) and [セクション 5.7](#), using ohm's law ($R = V \div I$).

Signals applied to the inputs need to have fast edge rates, as defined by $\Delta t/\Delta v$ in [セクション 5.3](#) and [セクション 5.4](#) to avoid excessive currents and oscillations. If a slow or noisy input signal is required, a device with a Schmitt-trigger input should be utilized to condition the input signal prior to the standard CMOS input.

7.3.3 Clamp Diodes

The inputs to this device have negative clamping diodes. The outputs to this device have both positive and negative clamping diodes as shown in [図 7-2](#).

注意

Voltages beyond the values specified in the [セクション 5.1](#) table can cause damage to the device. The input negative-voltage and output voltage ratings may be exceeded if the input and output clamp-current ratings are observed.



図 7-2. Electrical Placement of Clamping Diodes for Each Input and Output

7.3.4 Over-voltage Tolerant Inputs

Input signals to this device can be driven above the supply voltage so long as they remain below the maximum input voltage value specified in the [セクション 5.1](#).

7.4 Device Functional Modes

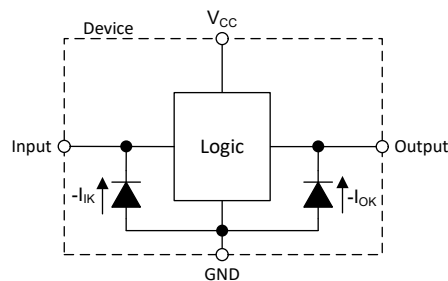
[表 7-1](#) lists the functional modes for the SN54LVC08A and SN74LVC08A devices.

表 7-1. Truth Table

INPUTS		OUTPUT
A	B	Y
L	L	L
L	H	L
H	L	L
H	H	H

8 Application and Implementation

注

以下のアプリケーション情報は、TI の製品仕様に含まれるものではなく、TI ではその正確性または完全性を保証いたしません。個々の目的に対する製品の適合性については、お客様の責任で判断していただくことになります。お客様は自身の設計実装を検証しテストすることで、システムの機能を確認する必要があります。

8.1 Application Information

The SN74LVC08A is used to drive CMOS device and used for implementing AND logic. The LVC family can support current drive of about 24 mA at 3-V V_{CC} . The inputs for SN74LVC08A are 5.5-V tolerant allowing it to translate down to V_{CC} .

8.2 Typical Application



図 8-1. Three Input AND Gate Implementation and Driving LED

8.2.1 Design Requirements

This device uses CMOS technology and has balanced output drive. Take care to avoid bus contention because it can drive currents that would exceed maximum limits. The high drive will also create fast edges into light loads so routing and load conditions should be considered to prevent ringing.

8.2.2 Detailed Design Procedure

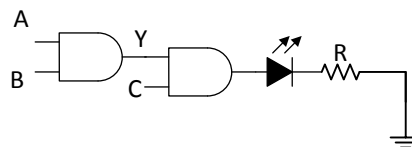
SN74LVC08A contains four AND gates in one package which can be used for individual AND function or to implement complex Boolean logic. 図 8-1 shows an example of implementing 3input AND function. AB are inputs for AND gate which are connected to another AND gate. $Z = A \times B \times C$. SN74LVC08A support high drive current of 24 mA which can be used to drive LEDs of even Drive low current signal FETs, an example is shown in 図 8-1 TI recommends to use a series resistance to limit the current. If V_{CC} is 3 V, and LED current should be 10 mA, and the forward-voltage of LED is 2.5 V, then R as shown in 図 8-1 is calculated using 式 1:

$$R = (V_{CC} - V_{LED}) / I \quad (1)$$

$$R = (3 - 2.5) / 0.01 = 50 \Omega$$

8.2.3 Application Curves

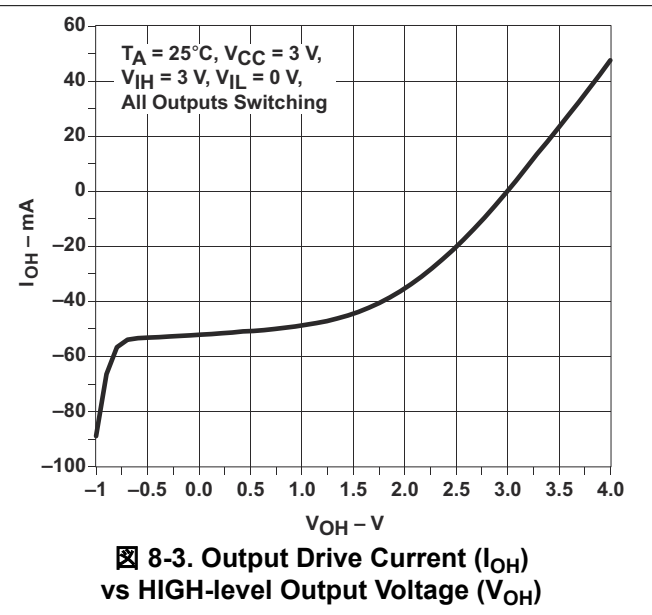
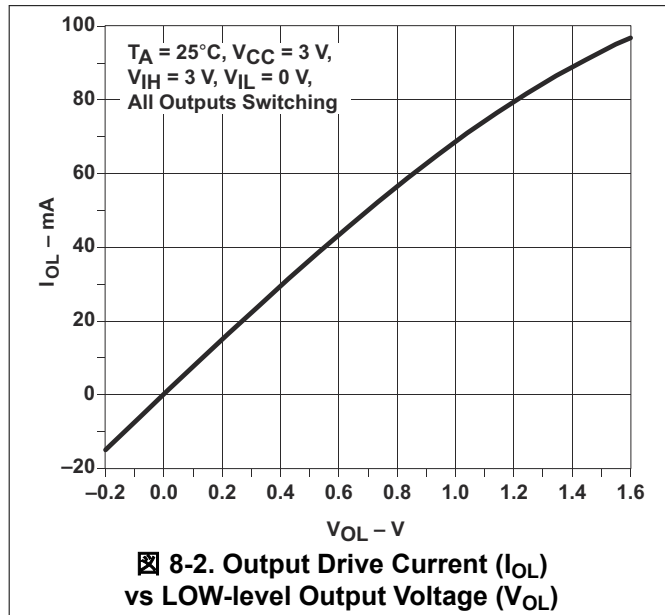

Power Supply Recommendations

The power supply can be any voltage between the minimum and maximum supply voltage rating located in the [Recommended Operating Conditions](#) table.

The V_{CC} pin must have a good bypass capacitor to prevent power disturbance. TI recommends to use a 0.1- μF capacitor. It is ok to parallel multiple bypass capacitors to reject different frequencies of noise. 0.1- μF and 1- μF capacitors are commonly used in parallel. The bypass capacitor should be installed as close to the power pin as possible for best results.

8.3 Layout

8.3.1 Layout Guidelines

When using multiple bit logic devices, inputs should not float. In many cases, functions or parts of functions of digital logic devices are unused. Some examples are when only two inputs of a triple-input AND gate are used, or when only 3 of the 4-buffer gates are used. Such input pins should not be left unconnected because the undefined voltages at the outside connections result in undefined operational states.

Specified in [图 8-4](#) are rules that must be observed under all circumstances. All unused inputs of digital logic devices must be connected to a high or low bias to prevent them from floating. The logic level that should be applied to any particular unused input depends on the function of the device. Generally they will be tied to GND or VCC, whichever makes more sense or is more convenient.

Even low data rate digital signals can have high frequency signal components due to fast edge rates. When a PCB trace turns a corner at a 90° angle, a reflection can occur. A reflection occurs primarily because of the change of width of the trace. At the apex of the turn, the trace width increases to 1.414 times the width. This increase upsets the transmission-line characteristics, especially the distributed capacitance and self-inductance of the trace which results in the reflection. Not all PCB traces can be straight and therefore some traces must turn corners. [图 8-5](#) shows progressively better techniques of rounding corners. Only the last example (BEST) maintains constant trace width and minimizes reflections.

8.3.2 Layout Examples



图 8-4. Example Layout



图 8-5. Trace Example

9 Device and Documentation Support

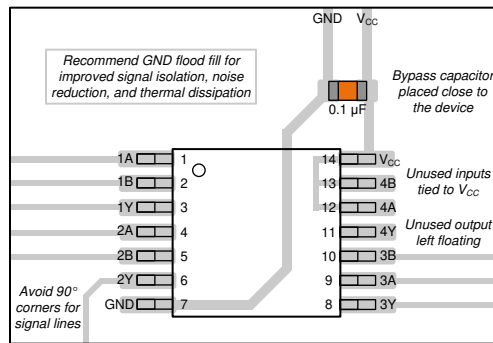
9.1 Documentation Support (Analog)

9.1.1 Related Documentation

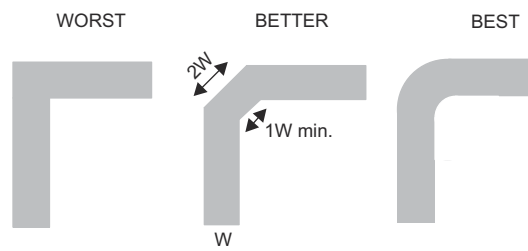
For related documentation see the following:

[Implications of Slow or Floating CMOS Inputs](#), SCBA004

9.1.2 Related Links

The table below lists quick access links. Categories include technical documents, support and community resources, tools and software, and quick access to order now.

表 9-1. Related Links

PARTS	PRODUCT FOLDER	ORDER NOW	TECHNICAL DOCUMENTS	TOOLS & SOFTWARE	SUPPORT & COMMUNITY
SN54LVC08A	Click here	Click here	Click here	Click here	Click here
SN74LVC08A	Click here	Click here	Click here	Click here	Click here

9.2 Receiving Notification of Documentation Updates

To receive notification of documentation updates, navigate to the device product folder on ti.com. In the upper right corner, click on *Alert me* to register and receive a weekly digest of any product information that has changed. For change details, review the revision history included in any revised document.

9.3 サポート・リソース

[テキサス・インスツルメンツ E2E™ サポート・フォーラム](#)は、エンジニアが検証済みの回答と設計に関するヒントをエキスパートから迅速かつ直接得ることができる場所です。既存の回答を検索したり、独自の質問をしたりすることで、設計に必要な支援を迅速に得ることができます。

リンクされているコンテンツは、各寄稿者により「現状のまま」提供されるものです。これらはテキサス・インスツルメンツの仕様を構成するものではなく、必ずしもテキサス・インスツルメンツの見解を反映したものではありません。テキサス・インスツルメンツの[使用条件](#)を参照してください。

9.3.1 Community Resources

9.4 Trademarks

テキサス・インスツルメンツ E2E™ is a trademark of Texas Instruments.

すべての商標は、それぞれの所有者に帰属します。

9.5 静電気放電に関する注意事項



この IC は、ESD によって破損する可能性があります。テキサス・インスツルメンツは、IC を取り扱う際には常に適切な注意を払うことを推奨します。正しい取り扱いおよび設置手順に従わない場合、デバイスを破損するおそれがあります。

ESD による破損は、わずかな性能低下からデバイスの完全な故障まで多岐にわたります。精密な IC の場合、パラメータがわずかに変化するだけで公表されている仕様から外れる可能性があるため、破損が発生しやすくなっています。

9.6 用語集

[テキサス・インスツルメンツ用語集](#) この用語集には、用語や略語の一覧および定義が記載されています。

10

資料番号末尾の英字は改訂を表しています。その改訂履歴は英語版に準じています。

Changes from Revision V (May 2024) to Revision W (July 2024)	Page
<ul style="list-style-type: none"> • Updated thermal values for D package from RθJA = 98.6 to 127.8, RθJC(top) = 56.0 to 81.9, RθJB = 53.3 to 84.4, ΨJT = 16.4 to 39.6, ΨJB = 53.0 to 83.9, RθJC(bot) = N/A, all values in °C/W 	6

Changes from Revision U (March 2024) to Revision V (May 2024)	Page
<ul style="list-style-type: none"> • Updated RθJA values: DB = 112.8 to 140.4, PW = 127.7 to 150.8, RGY = 51.1 to 92.1, NS = 95.1 to 123.8; updated DB, PW, RGY, and NS packages for RθJC(top), RθJB, ΨJT, ΨJB, and RθJC(bot), all values in °C/W..... 	6

11 Mechanical, Packaging, and Orderable Information

The following pages include mechanical, packaging, and orderable information. This information is the most current data available for the designated devices. This data is subject to change without notice and revision of this document. For browser-based versions of this data sheet, refer to the left-hand navigation.

PACKAGING INFORMATION

Orderable Device	Status (1)	Package Type	Package Drawing	Pins	Package Qty	Eco Plan (2)	Lead finish/ Ball material (6)	MSL Peak Temp (3)	Op Temp (°C)	Device Marking (4/5)	Samples
5962-9753401Q2A	ACTIVE	LCCC	FK	20	55	Non-RoHS & Green	SNPB	N / A for Pkg Type	-55 to 125	5962-9753401Q2A SNJ54LVC08AFK	Samples
5962-9753401QCA	ACTIVE	CDIP	J	14	25	Non-RoHS & Green	SNPB	N / A for Pkg Type	-55 to 125	5962-9753401QC A SNJ54LVC08AJ	Samples
5962-9753401QDA	ACTIVE	CFP	W	14	25	Non-RoHS & Green	SNPB	N / A for Pkg Type	-55 to 125	5962-9753401QD A SNJ54LVC08AW	Samples
SN74LVC08ABQAR	ACTIVE	WQFN	BQA	14	3000	RoHS & Green	NIPDAU	Level-1-260C-UNLIM	-40 to 125	LVC08A	Samples
SN74LVC08AD	ACTIVE	SOIC	D	14	50	RoHS & Green	NIPDAU	Level-1-260C-UNLIM	-40 to 125	LVC08A	Samples
SN74LVC08ADBR	ACTIVE	SSOP	DB	14	2000	RoHS & Green	NIPDAU	Level-1-260C-UNLIM	-40 to 125	LC08A	Samples
SN74LVC08ADBRE4	ACTIVE	SSOP	DB	14	2000	RoHS & Green	NIPDAU	Level-1-260C-UNLIM	-40 to 125	LC08A	Samples
SN74LVC08ADE4	ACTIVE	SOIC	D	14	50	RoHS & Green	NIPDAU	Level-1-260C-UNLIM	-40 to 125	LVC08A	Samples
SN74LVC08ADG4	ACTIVE	SOIC	D	14	50	RoHS & Green	NIPDAU	Level-1-260C-UNLIM	-40 to 125	LVC08A	Samples
SN74LVC08ADR	ACTIVE	SOIC	D	14	2500	RoHS & Green	NIPDAU SN	Level-1-260C-UNLIM	-40 to 125	LVC08A	Samples
SN74LVC08ADRE4	ACTIVE	SOIC	D	14	2500	RoHS & Green	NIPDAU	Level-1-260C-UNLIM	-40 to 125	LVC08A	Samples
SN74LVC08ADRG3	ACTIVE	SOIC	D	14	2500	RoHS & Green	SN	Level-1-260C-UNLIM	-40 to 125	LVC08A	Samples
SN74LVC08ADRG4	ACTIVE	SOIC	D	14	2500	RoHS & Green	NIPDAU	Level-1-260C-UNLIM	-40 to 125	LVC08A	Samples
SN74LVC08ADT	ACTIVE	SOIC	D	14	250	RoHS & Green	NIPDAU	Level-1-260C-UNLIM	-40 to 125	LVC08A	Samples
SN74LVC08ANSR	ACTIVE	SOP	NS	14	2000	RoHS & Green	NIPDAU	Level-1-260C-UNLIM	-40 to 125	LVC08A	Samples
SN74LVC08ANSRE4	ACTIVE	SOP	NS	14	2000	RoHS & Green	NIPDAU	Level-1-260C-UNLIM	-40 to 125	LVC08A	Samples
SN74LVC08APW	ACTIVE	TSSOP	PW	14	90	RoHS & Green	NIPDAU	Level-1-260C-UNLIM	-40 to 125	LC08A	Samples

Orderable Device	Status (1)	Package Type	Package Drawing	Pins	Package Qty	Eco Plan (2)	Lead finish/ Ball material (6)	MSL Peak Temp (3)	Op Temp (°C)	Device Marking (4/5)	Samples
SN74LVC08APWG4	ACTIVE	TSSOP	PW	14	90	RoHS & Green	NIPDAU	Level-1-260C-UNLIM	-40 to 125	LC08A	Samples
SN74LVC08APWR	ACTIVE	TSSOP	PW	14	2000	RoHS & Green	NIPDAU SN	Level-1-260C-UNLIM	-40 to 125	LC08A	Samples
SN74LVC08APWRE4	ACTIVE	TSSOP	PW	14	2000	RoHS & Green	NIPDAU	Level-1-260C-UNLIM	-40 to 125	LC08A	Samples
SN74LVC08APWRG3	ACTIVE	TSSOP	PW	14	2000	RoHS & Green	SN	Level-1-260C-UNLIM	-40 to 125	LC08A	Samples
SN74LVC08APWRG4	ACTIVE	TSSOP	PW	14	2000	RoHS & Green	NIPDAU	Level-1-260C-UNLIM	-40 to 125	LC08A	Samples
SN74LVC08APWT	ACTIVE	TSSOP	PW	14	250	RoHS & Green	NIPDAU	Level-1-260C-UNLIM	-40 to 125	LC08A	Samples
SN74LVC08APWTG4	ACTIVE	TSSOP	PW	14	250	RoHS & Green	NIPDAU	Level-1-260C-UNLIM	-40 to 125	LC08A	Samples
SN74LVC08ARGYR	ACTIVE	VQFN	RGY	14	3000	RoHS & Green	NIPDAU	Level-2-260C-1 YEAR	-40 to 125	LC08A	Samples
SN74LVC08ARGYRG4	ACTIVE	VQFN	RGY	14	3000	RoHS & Green	NIPDAU	Level-2-260C-1 YEAR	-40 to 125	LC08A	Samples
SNJ54LVC08AFK	ACTIVE	LCCC	FK	20	55	Non-RoHS & Green	SNPB	N / A for Pkg Type	-55 to 125	5962-9753401Q2A SNJ54LVC08AFK	Samples
SNJ54LVC08AJ	ACTIVE	CDIP	J	14	25	Non-RoHS & Green	SNPB	N / A for Pkg Type	-55 to 125	5962-9753401QC A SNJ54LVC08AJ	Samples
SNJ54LVC08AW	ACTIVE	CFP	W	14	25	Non-RoHS & Green	SNPB	N / A for Pkg Type	-55 to 125	5962-9753401QD A SNJ54LVC08AW	Samples

(1) The marketing status values are defined as follows:

ACTIVE: Product device recommended for new designs.

LIFEBUY: TI has announced that the device will be discontinued, and a lifetime-buy period is in effect.

NRND: Not recommended for new designs. Device is in production to support existing customers, but TI does not recommend using this part in a new design.

PREVIEW: Device has been announced but is not in production. Samples may or may not be available.

OBSELETE: TI has discontinued the production of the device.

(2) **RoHS:** TI defines "RoHS" to mean semiconductor products that are compliant with the current EU RoHS requirements for all 10 RoHS substances, including the requirement that RoHS substance do not exceed 0.1% by weight in homogeneous materials. Where designed to be soldered at high temperatures, "RoHS" products are suitable for use in specified lead-free processes. TI may reference these types of products as "Pb-Free".

RoHS Exempt: TI defines "RoHS Exempt" to mean products that contain lead but are compliant with EU RoHS pursuant to a specific EU RoHS exemption.

Green: TI defines "Green" to mean the content of Chlorine (Cl) and Bromine (Br) based flame retardants meet JS709B low halogen requirements of ≤ 1000 ppm threshold. Antimony trioxide based flame retardants must also meet the ≤ 1000 ppm threshold requirement.

(3) MSL, Peak Temp. - The Moisture Sensitivity Level rating according to the JEDEC industry standard classifications, and peak solder temperature.

(4) There may be additional marking, which relates to the logo, the lot trace code information, or the environmental category on the device.

(5) Multiple Device Markings will be inside parentheses. Only one Device Marking contained in parentheses and separated by a "~" will appear on a device. If a line is indented then it is a continuation of the previous line and the two combined represent the entire Device Marking for that device.

(6) Lead finish/Ball material - Orderable Devices may have multiple material finish options. Finish options are separated by a vertical ruled line. Lead finish/Ball material values may wrap to two lines if the finish value exceeds the maximum column width.

Important Information and Disclaimer: The information provided on this page represents TI's knowledge and belief as of the date that it is provided. TI bases its knowledge and belief on information provided by third parties, and makes no representation or warranty as to the accuracy of such information. Efforts are underway to better integrate information from third parties. TI has taken and continues to take reasonable steps to provide representative and accurate information but may not have conducted destructive testing or chemical analysis on incoming materials and chemicals. TI and TI suppliers consider certain information to be proprietary, and thus CAS numbers and other limited information may not be available for release.

In no event shall TI's liability arising out of such information exceed the total purchase price of the TI part(s) at issue in this document sold by TI to Customer on an annual basis.

OTHER QUALIFIED VERSIONS OF SN54LVC08A, SN74LVC08A :

- Catalog : [SN74LVC08A](#)
- Automotive : [SN74LVC08A-Q1](#), [SN74LVC08A-Q1](#)
- Enhanced Product : [SN74LVC08A-EP](#), [SN74LVC08A-EP](#)
- Military : [SN54LVC08A](#)

NOTE: Qualified Version Definitions:

- Catalog - TI's standard catalog product
- Automotive - Q100 devices qualified for high-reliability automotive applications targeting zero defects
- Enhanced Product - Supports Defense, Aerospace and Medical Applications

- Military - QML certified for Military and Defense Applications

TAPE AND REEL INFORMATION

QUADRANT ASSIGNMENTS FOR PIN 1 ORIENTATION IN TAPE

*All dimensions are nominal

Device	Package Type	Package Drawing	Pins	SPQ	Reel Diameter (mm)	Reel Width W1 (mm)	A0 (mm)	B0 (mm)	K0 (mm)	P1 (mm)	W (mm)	Pin1 Quadrant
SN74LVC08ABQAR	WQFN	BQA	14	3000	180.0	12.4	2.8	3.3	1.1	4.0	12.0	Q1
SN74LVC08ADB	SSOP	DB	14	2000	330.0	16.4	8.35	6.6	2.4	12.0	16.0	Q1
SN74LVC08ADR	SOIC	D	14	2500	330.0	16.4	6.5	9.0	2.1	8.0	16.0	Q1
SN74LVC08ADRG3	SOIC	D	14	2500	330.0	16.8	6.5	9.5	2.1	8.0	16.0	Q1
SN74LVC08ADRG4	SOIC	D	14	2500	330.0	16.4	6.5	9.0	2.1	8.0	16.0	Q1
SN74LVC08ADT	SOIC	D	14	250	330.0	16.4	6.5	9.0	2.1	8.0	16.0	Q1
SN74LVC08ANSR	SOP	NS	14	2000	330.0	16.4	8.2	10.5	2.5	12.0	16.0	Q1
SN74LVC08APWR	TSSOP	PW	14	2000	330.0	12.4	6.9	5.6	1.6	8.0	12.0	Q1
SN74LVC08APWRG3	TSSOP	PW	14	2000	330.0	12.4	6.9	5.6	1.6	8.0	12.0	Q1
SN74LVC08APWRG4	TSSOP	PW	14	2000	330.0	12.4	6.9	5.6	1.6	8.0	12.0	Q1
SN74LVC08APWT	TSSOP	PW	14	250	330.0	12.4	6.9	5.6	1.6	8.0	12.0	Q1
SN74LVC08ARGYR	VQFN	RGY	14	3000	330.0	12.4	3.75	3.75	1.15	8.0	12.0	Q1

TAPE AND REEL BOX DIMENSIONS

*All dimensions are nominal

Device	Package Type	Package Drawing	Pins	SPQ	Length (mm)	Width (mm)	Height (mm)
SN74LVC08ABQAR	WQFN	BQA	14	3000	210.0	185.0	35.0
SN74LVC08ADBR	SSOP	DB	14	2000	356.0	356.0	35.0
SN74LVC08ADR	SOIC	D	14	2500	353.0	353.0	32.0
SN74LVC08ADRG3	SOIC	D	14	2500	364.0	364.0	27.0
SN74LVC08ADRG4	SOIC	D	14	2500	353.0	353.0	32.0
SN74LVC08ADT	SOIC	D	14	250	210.0	185.0	35.0
SN74LVC08ANSR	SOP	NS	14	2000	356.0	356.0	35.0
SN74LVC08APWR	TSSOP	PW	14	2000	356.0	356.0	35.0
SN74LVC08APWRG3	TSSOP	PW	14	2000	364.0	364.0	27.0
SN74LVC08APWRG4	TSSOP	PW	14	2000	356.0	356.0	35.0
SN74LVC08APWT	TSSOP	PW	14	250	356.0	356.0	35.0
SN74LVC08ARGYR	VQFN	RGY	14	3000	356.0	356.0	35.0

TUBE

*All dimensions are nominal

Device	Package Name	Package Type	Pins	SPQ	L (mm)	W (mm)	T (μm)	B (mm)
5962-9753401Q2A	FK	LCCC	20	55	506.98	12.06	2030	NA
5962-9753401QDA	W	CFP	14	25	506.98	26.16	6220	NA
SN74LVC08AD	D	SOIC	14	50	506.6	8	3940	4.32
SN74LVC08ADE4	D	SOIC	14	50	506.6	8	3940	4.32
SN74LVC08ADG4	D	SOIC	14	50	506.6	8	3940	4.32
SN74LVC08APW	PW	TSSOP	14	90	530	10.2	3600	3.5
SN74LVC08APWG4	PW	TSSOP	14	90	530	10.2	3600	3.5
SNJ54LVC08AFK	FK	LCCC	20	55	506.98	12.06	2030	NA
SNJ54LVC08AW	W	CFP	14	25	506.98	26.16	6220	NA

W (R-GDFP-F14)

CERAMIC DUAL FLATPACK



- NOTES:
- A. All linear dimensions are in inches (millimeters).
 - B. This drawing is subject to change without notice.
 - C. This package can be hermetically sealed with a ceramic lid using glass frit.
 - D. Index point is provided on cap for terminal identification only.
 - E. Falls within MIL STD 1835 GDFP1-F14

DB0014A



PACKAGE OUTLINE

SSOP - 2 mm max height

SMALL OUTLINE PACKAGE



4220762/A 05/2024

NOTES:

- All linear dimensions are in millimeters. Any dimensions in parenthesis are for reference only. Dimensioning and tolerancing per ASME Y14.5M.
- This drawing is subject to change without notice.
- This dimension does not include mold flash, protrusions, or gate burrs. Mold flash, protrusions, or gate burrs shall not exceed 0.15 mm per side.
- Reference JEDEC registration MO-150.

EXAMPLE BOARD LAYOUT

DB0014A

SSOP - 2 mm max height

SMALL OUTLINE PACKAGE



LAND PATTERN EXAMPLE
EXPOSED METAL SHOWN
SCALE: 10X



4220762/A 05/2024

NOTES: (continued)

- 5. Publication IPC-7351 may have alternate designs.
- 6. Solder mask tolerances between and around signal pads can vary based on board fabrication site.

EXAMPLE STENCIL DESIGN

DB0014A

SSOP - 2 mm max height

SMALL OUTLINE PACKAGE



SOLDER PASTE EXAMPLE
BASED ON 0.125 mm THICK STENCIL
SCALE: 10X

4220762/A 05/2024

NOTES: (continued)

7. Laser cutting apertures with trapezoidal walls and rounded corners may offer better paste release. IPC-7525 may have alternate design recommendations.
8. Board assembly site may have different recommendations for stencil design.

GENERIC PACKAGE VIEW

FK 20

LCCC - 2.03 mm max height

8.89 x 8.89, 1.27 mm pitch

LEADLESS CERAMIC CHIP CARRIER

This image is a representation of the package family, actual package may vary.
Refer to the product data sheet for package details.



4229370VA\

J 14

GENERIC PACKAGE VIEW
CDIP - 5.08 mm max height
CERAMIC DUAL IN LINE PACKAGE



Images above are just a representation of the package family, actual package may vary.
Refer to the product data sheet for package details.

4040083-5/G

J0014A



PACKAGE OUTLINE

CDIP - 5.08 mm max height

CERAMIC DUAL IN LINE PACKAGE



4214771/A 05/2017

NOTES:

- All controlling linear dimensions are in inches. Dimensions in brackets are in millimeters. Any dimension in brackets or parenthesis are for reference only. Dimensioning and tolerancing per ASME Y14.5M.
- This drawing is subject to change without notice.
- This package is hermetically sealed with a ceramic lid using glass frit.
- Index point is provided on cap for terminal identification only and on press ceramic glass frit seal only.
- Falls within MIL-STD-1835 and GDIP1-T14.

EXAMPLE BOARD LAYOUT

J0014A

CDIP - 5.08 mm max height

CERAMIC DUAL IN LINE PACKAGE



LAND PATTERN EXAMPLE
NON-SOLDER MASK DEFINED
SCALE: 5X



4214771/A 05/2017



NOTES:

1. All linear dimensions are in millimeters. Any dimensions in parenthesis are for reference only. Dimensioning and tolerancing per ASME Y14.5M.
2. This drawing is subject to change without notice.
3. This dimension does not include mold flash, protrusions, or gate burrs. Mold flash, protrusions, or gate burrs shall not exceed 0.15 mm per side.
4. This dimension does not include interlead flash. Interlead flash shall not exceed 0.25 mm per side.
5. Reference JEDEC registration MO-153.

EXAMPLE BOARD LAYOUT

PW0014A

TSSOP - 1.2 mm max height

SMALL OUTLINE PACKAGE



LAND PATTERN EXAMPLE
EXPOSED METAL SHOWN
SCALE: 10X



4220202/B 12/2023

NOTES: (continued)

- 6. Publication IPC-7351 may have alternate designs.
- 7. Solder mask tolerances between and around signal pads can vary based on board fabrication site.

EXAMPLE STENCIL DESIGN

PW0014A

TSSOP - 1.2 mm max height

SMALL OUTLINE PACKAGE



SOLDER PASTE EXAMPLE
BASED ON 0.125 mm THICK STENCIL
SCALE: 10X

4220202/B 12/2023

NOTES: (continued)

8. Laser cutting apertures with trapezoidal walls and rounded corners may offer better paste release. IPC-7525 may have alternate design recommendations.
9. Board assembly site may have different recommendations for stencil design.

GENERIC PACKAGE VIEW

RGY 14

VQFN - 1 mm max height

3.5 x 3.5, 0.5 mm pitch

PLASTIC QUAD FLATPACK - NO LEAD

This image is a representation of the package family, actual package may vary.
Refer to the product data sheet for package details.



4231541/A

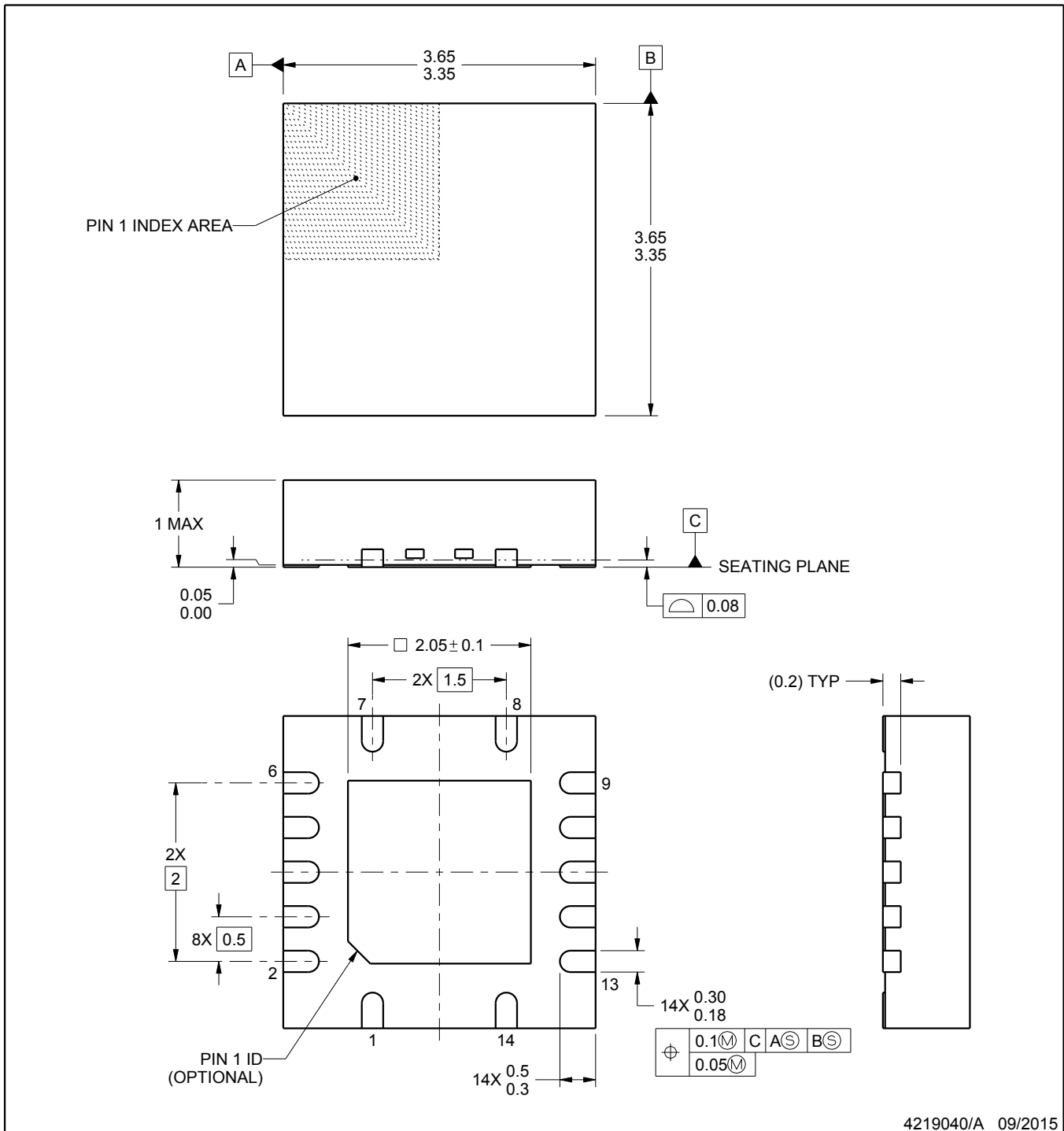

4219040/A 09/2015

NOTES:

1. All linear dimensions are in millimeters. Any dimensions in parenthesis are for reference only. Dimensioning and tolerancing per ASME Y14.5M.
2. This drawing is subject to change without notice.
3. The package thermal pad must be soldered to the printed circuit board for thermal and mechanical performance.

EXAMPLE BOARD LAYOUT

RGY0014A

VQFN - 1 mm max height

PLASTIC QUAD FLATPACK - NO LEAD



LAND PATTERN EXAMPLE
SCALE:20X

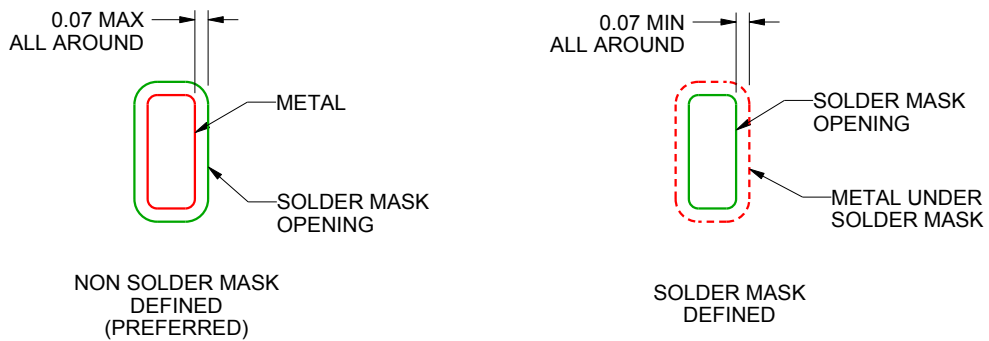

SOLDER MASK DETAILS

4219040/A 09/2015

NOTES: (continued)

4. This package is designed to be soldered to a thermal pad on the board. For more information, see Texas Instruments literature number SLUA271 (www.ti.com/lit/slue271).

EXAMPLE STENCIL DESIGN

RGY0014A

VQFN - 1 mm max height

PLASTIC QUAD FLATPACK - NO LEAD

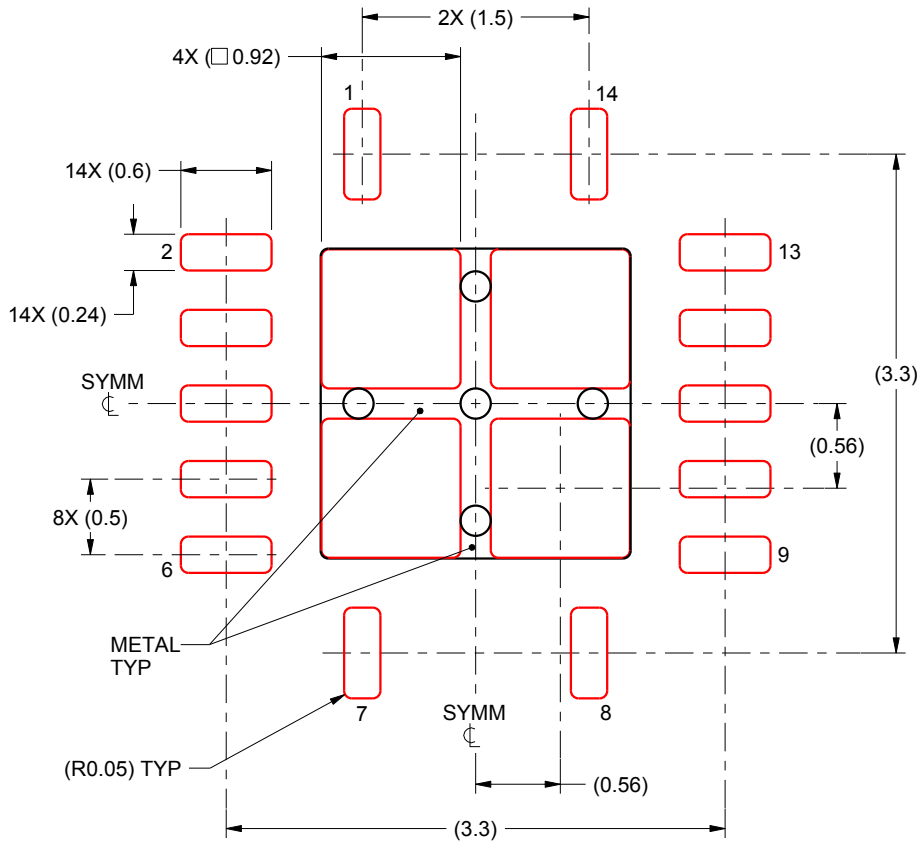

SOLDER PASTE EXAMPLE
BASED ON 0.125 mm THICK STENCIL

EXPOSED PAD
80% PRINTED SOLDER COVERAGE BY AREA
SCALE:20X

4219040/A 09/2015

NOTES: (continued)

5. Laser cutting apertures with trapezoidal walls and rounded corners may offer better paste release. IPC-7525 may have alternate design recommendations.

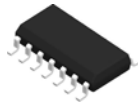

D0014A

PACKAGE OUTLINE

SOIC - 1.75 mm max height

SMALL OUTLINE INTEGRATED CIRCUIT



4220718/A 09/2016

NOTES:

1. All linear dimensions are in millimeters. Dimensions in parenthesis are for reference only. Dimensioning and tolerancing per ASME Y14.5M.
2. This drawing is subject to change without notice.
3. This dimension does not include mold flash, protrusions, or gate burrs. Mold flash, protrusions, or gate burrs shall not exceed 0.15 mm, per side.
4. This dimension does not include interlead flash. Interlead flash shall not exceed 0.43 mm, per side.
5. Reference JEDEC registration MS-012, variation AB.

EXAMPLE BOARD LAYOUT

D0014A

SOIC - 1.75 mm max height

SMALL OUTLINE INTEGRATED CIRCUIT



LAND PATTERN EXAMPLE
SCALE:8X



SOLDER MASK DETAILS

4220718/A 09/2016

NOTES: (continued)

6. Publication IPC-7351 may have alternate designs.
7. Solder mask tolerances between and around signal pads can vary based on board fabrication site.

EXAMPLE STENCIL DESIGN

D0014A

SOIC - 1.75 mm max height

SMALL OUTLINE INTEGRATED CIRCUIT



SOLDER PASTE EXAMPLE
BASED ON 0.125 mm THICK STENCIL
SCALE:8X

4220718/A 09/2016

NOTES: (continued)

8. Laser cutting apertures with trapezoidal walls and rounded corners may offer better paste release. IPC-7525 may have alternate design recommendations.
9. Board assembly site may have different recommendations for stencil design.

GENERIC PACKAGE VIEW

BQA 14

WQFN - 0.8 mm max height

2.5 x 3, 0.5 mm pitch

PLASTIC QUAD FLATPACK - NO LEAD

This image is a representation of the package family, actual package may vary.
Refer to the product data sheet for package details.

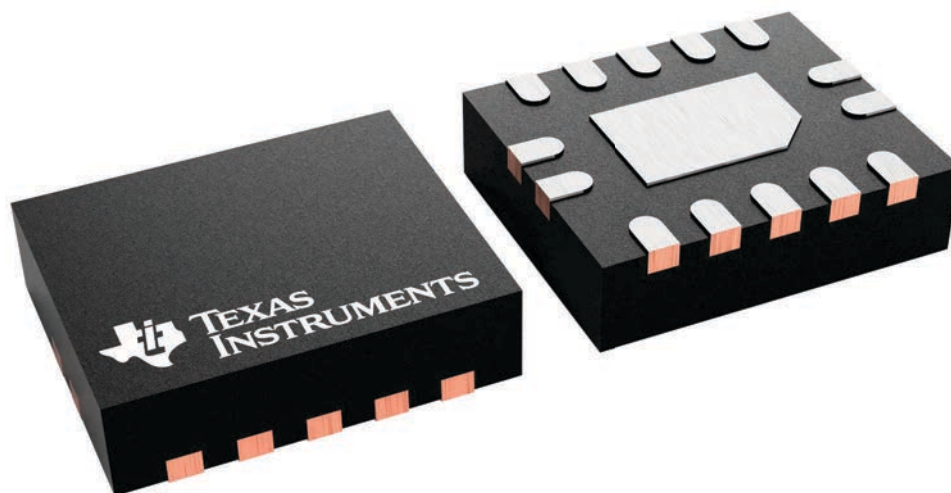

4227145/A

EXAMPLE BOARD LAYOUT

WQFN - 0.8 mm max height

BQA0014A

PLASTIC QUAD FLAT PACK-NO LEAD



LAND PATTERN EXAMPLE
EXPOSED METAL SHOWN
SCALE: 20X

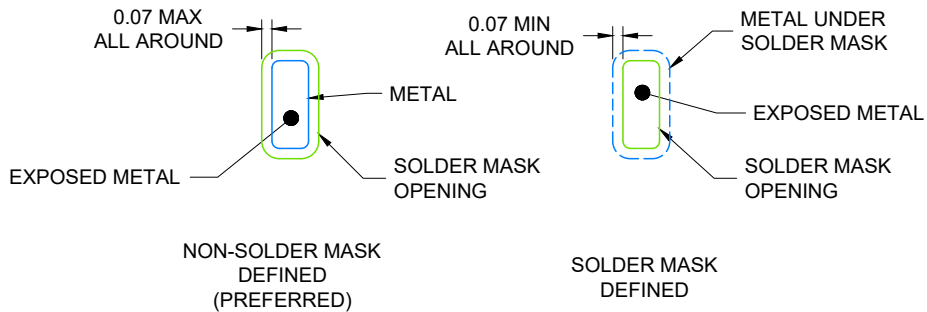

4224636/A 11/2018

NOTES: (continued)

4. This package is designed to be soldered to a thermal pad on the board. For more information, see Texas Instruments literature number SLUA271 (www.ti.com/lit/slua271).
5. Vias are optional depending on application, refer to device data sheet. If any vias are implemented, refer to their locations shown on this view. It is recommended that vias under paste be filled, plugged or tented.

EXAMPLE STENCIL DESIGN

BQA0014A

WQFN - 0.8 mm max height

PLASTIC QUAD FLAT PACK-NO LEAD



SOLDER PASTE EXAMPLE
 BASED ON 0.125 mm THICK STENCIL

EXPOSED PAD
 88% PRINTED COVERAGE BY AREA
 SCALE: 20X

4224636/A 11/2018

NOTES: (continued)

- 6. Laser cutting apertures with trapezoidal walls and rounded corners may offer better paste release. IPC-7525 may have alternate design recommendations.

MECHANICAL DATA

NS (R-PDSO-G**)

PLASTIC SMALL-OUTLINE PACKAGE

14-PINS SHOWN



- NOTES:
- A. All linear dimensions are in millimeters.
 - B. This drawing is subject to change without notice.
 - C. Body dimensions do not include mold flash or protrusion, not to exceed 0,15.

重要なお知らせと免責事項

テキサス・インスツルメンツは、技術データと信頼性データ(データシートを含みます)、設計リソース(リファレンス デザインを含みます)、アプリケーションや設計に関する各種アドバイス、Web ツール、安全性情報、その他のリソースを、欠陥が存在する可能性のある「現状のまま」提供しており、商品性および特定目的に対する適合性の黙示保証、第三者の知的財産権の非侵害保証を含むいかなる保証も、明示的または黙示的にかかわらず拒否します。

これらのリソースは、テキサス・インスツルメンツ製品を使用する設計の経験を積んだ開発者への提供を意図したものです。(1) お客様のアプリケーションに適したテキサス・インスツルメンツ製品の選定、(2) お客様のアプリケーションの設計、検証、試験、(3) お客様のアプリケーションに該当する各種規格や、その他のあらゆる安全性、セキュリティ、規制、または他の要件への確実な適合に関する責任を、お客様のみが単独で負うものとします。

上記の各種リソースは、予告なく変更される可能性があります。これらのリソースは、リソースで説明されているテキサス・インスツルメンツ製品を使用するアプリケーションの開発の目的でのみ、テキサス・インスツルメンツはその使用をお客様に許諾します。これらのリソースに関して、他の目的で複製することや掲載することは禁止されています。テキサス・インスツルメンツや第三者の知的財産権のライセンスが付与されている訳ではありません。お客様は、これらのリソースを自身で使用した結果発生するあらゆる申し立て、損害、費用、損失、責任について、テキサス・インスツルメンツおよびその代理人を完全に補償するものとし、テキサス・インスツルメンツは一切の責任を拒否します。

テキサス・インスツルメンツの製品は、[テキサス・インスツルメンツの販売条件](#)、または [ti.com](https://www.ti.com) やかかるテキサス・インスツルメンツ製品の関連資料などのいずれかを通じて提供する適用可能な条項の下で提供されています。テキサス・インスツルメンツがこれらのリソースを提供することは、適用されるテキサス・インスツルメンツの保証または他の保証の放棄の拡大や変更を意味するものではありません。

お客様がいかなる追加条項または代替条項を提案した場合でも、テキサス・インスツルメンツはそれらに異議を唱え、拒否します。

郵送先住所：Texas Instruments, Post Office Box 655303, Dallas, Texas 75265
Copyright © 2025, Texas Instruments Incorporated