

## SNx4LVC04A Hex Inverters

### 1 Features

- Operate From 1.65 V to 3.6 V
- Specified From  $-40^{\circ}\text{C}$  to  $85^{\circ}\text{C}$ ,  $-40^{\circ}\text{C}$  to  $125^{\circ}\text{C}$ , and  $-55^{\circ}\text{C}$  to  $125^{\circ}\text{C}$
- Inputs Accept Voltages to 5.5 V
- Maximum  $t_{pd}$  of 4.5 ns at 3.3 V
- Typical  $V_{OLP}$  (Output Ground Bounce)  $<0.8\text{ V}$  at  $V_{CC} = 3.3\text{ V}$ ,  $T_A = 25^{\circ}\text{C}$
- Typical  $V_{OHV}$  (Output  $V_{OH}$  Undershoot)  $>2\text{ V}$  at  $V_{CC} = 3.3\text{ V}$ ,  $T_A = 25^{\circ}\text{C}$
- Latch-Up Performance Exceeds 250 mA Per JESD 17
- ESD Protection Exceeds JESD 22
  - 2000-V Human-Body Model (A114-A)
  - 200-V Machine Model (A115-A)
  - 1000-V Charged-Device Model (C101)

### 2 Applications

- Power Sub-Station Controls
- Ethernet Switches
- Flow Meters
- I/O Modules and Digital PLC/DCS Inputs
- Servers
- Tests and Measurement

### 3 Description

The SNx4LVC04A hex inverters contains six independent inverters designed for 2.7-V to 3.6-V  $V_{CC}$  operation, and the SN74LVC04A hex inverter contains six independent inverters designed for 1.65-V to 3.6-V  $V_{CC}$  operation. The SNx4LVC04A devices perform the Boolean function  $Y = \bar{A}$ .

Inputs can be driven from 1.8-V or 3.3-V devices. This feature allows the use of these devices as translators in a mixed 1.8-V or 3.3-V system environment.

#### Device Information<sup>(1)</sup>

PART NUMBER	PACKAGE	BODY SIZE (NOM)
SN54LVC04A	CDIP (14)	19.56 mm x 6.67 mm
	CFP (14)	9.21 mm x 5.97 mm
	LCCC (20)	8.89 mm x 8.89 mm
SN74LVC04A	SOIC (14)	8.65 mm x 3.91 mm
	SSOP (14)	6.20 mm x 5.30 mm
	TVSOP (14)	3.60 mm x 4.40 mm
	SOP (14)	6.20 mm x 5.30 mm
	TSSOP (14)	5.00 mm x 4.40 mm
	VQFN (14)	3.50 mm x 3.50 mm

(1) For all available packages, see the orderable addendum at the end of the data sheet.

#### Logic Diagram, Each Inverter (Positive Logic)

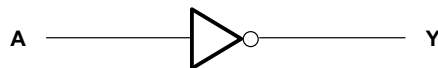

Copyright © 2016, Texas Instruments Incorporated



An IMPORTANT NOTICE at the end of this data sheet addresses availability, warranty, changes, use in safety-critical applications, intellectual property matters and other important disclaimers. PRODUCTION DATA.

On products compliant to MIL-PRF-38535, all parameters are tested unless otherwise noted. On all other products, production processing does not necessarily include testing of all parameters.

## Table of Contents

<b>1 Features</b> .....	<b>1</b>	8.2 Functional Block Diagram .....	<b>11</b>
<b>2 Applications</b> .....	<b>1</b>	8.3 Feature Description .....	<b>11</b>
<b>3 Description</b> .....	<b>1</b>	8.4 Device Functional Modes .....	<b>11</b>
<b>4 Revision History</b> .....	<b>2</b>	<b>9 Application and Implementation</b> .....	<b>12</b>
<b>5 Pin Configuration and Functions</b> .....	<b>3</b>	9.1 Application Information .....	<b>12</b>
<b>6 Specifications</b> .....	<b>5</b>	9.2 Typical Application .....	<b>12</b>
6.1 Absolute Maximum Ratings .....	<b>5</b>	<b>10 Power Supply Recommendations</b> .....	<b>13</b>
6.2 ESD Ratings .....	<b>5</b>	<b>11 Layout</b> .....	<b>13</b>
6.3 Recommended Operating Conditions .....	<b>5</b>	11.1 Layout Guidelines .....	<b>13</b>
6.4 Thermal Information – SN54LVC04A .....	<b>6</b>	11.2 Layout Example .....	<b>13</b>
6.5 Thermal Information – SN74LVC04A .....	<b>6</b>	<b>12 Device and Documentation Support</b> .....	<b>14</b>
6.6 Electrical Characteristics – SN54LVC04A .....	<b>7</b>	12.1 Documentation Support .....	<b>14</b>
6.7 Electrical Characteristics – SN74LVC04A .....	<b>7</b>	12.2 Related Links .....	<b>14</b>
6.8 Switching Characteristics .....	<b>8</b>	12.3 Receiving Notification of Documentation Updates .....	<b>14</b>
6.9 Operating Characteristics .....	<b>8</b>	12.4 Community Resources .....	<b>14</b>
6.10 Typical Characteristics .....	<b>9</b>	12.5 Trademarks .....	<b>14</b>
<b>7 Parameter Measurement Information</b> .....	<b>10</b>	12.6 Electrostatic Discharge Caution .....	<b>14</b>
<b>8 Detailed Description</b> .....	<b>11</b>	12.7 Glossary .....	<b>14</b>
8.1 Overview .....	<b>11</b>	<b>13 Mechanical, Packaging, and Orderable Information</b> .....	<b>14</b>

## 4 Revision History

NOTE: Page numbers for previous revisions may differ from page numbers in the current version.

### Changes from Revision S (October 2010) to Revision T

Page

• Added <i>Applications</i> section, <i>ESD Ratings</i> table, <i>Feature Description</i> section, <i>Device Functional Modes</i> , <i>Application and Implementation</i> section, <i>Power Supply Recommendations</i> section, <i>Layout</i> section, <i>Device and Documentation Support</i> section, and <i>Mechanical, Packaging, and Orderable Information</i> section .....	<b>1</b>
• Deleted <i>Ordering Information</i> table; see <i>Package Option Addendum</i> at the end of the data sheet .....	<b>1</b>
• Added <i>Thermal Information Table – SN54LVC04A</i> .....	<b>6</b>
• Changed Package thermal impedance, $R_{\theta JA}$ , values in <i>Thermal Information – SN74LVC04A</i> From: 96 To: 113.1 (DB), From: 127 To: 142.7 (DGV), From: 76 To: 95.4 (NS), From: 113 To: 129.5 (PW), and From: 47 To: 63.2 (RGY) .....	<b>6</b>

## 5 Pin Configuration and Functions

**D, DB, DGV, J, NS, PW, or W Package**  
**14-Pin SOIC, SSOP, TVSOP, CDIP, SOP, TSSOP, or CFP**  
**Top View**

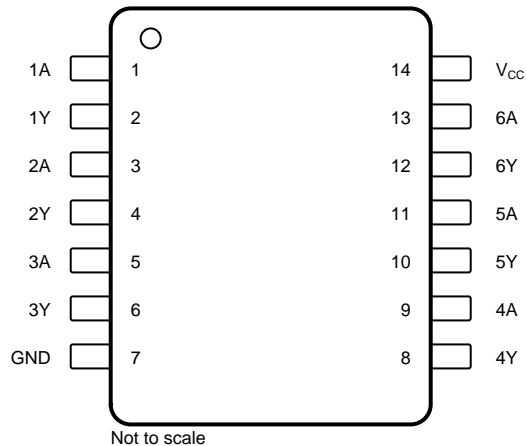

Not to scale

**RGY Package**  
**14-Pin VQFN With Exposed Thermal Pad**  
**Top View**

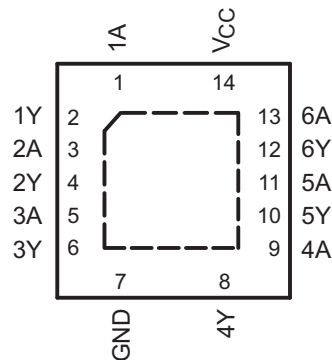

**FK Package**  
**20-Pin LCCC**  
**Top View**

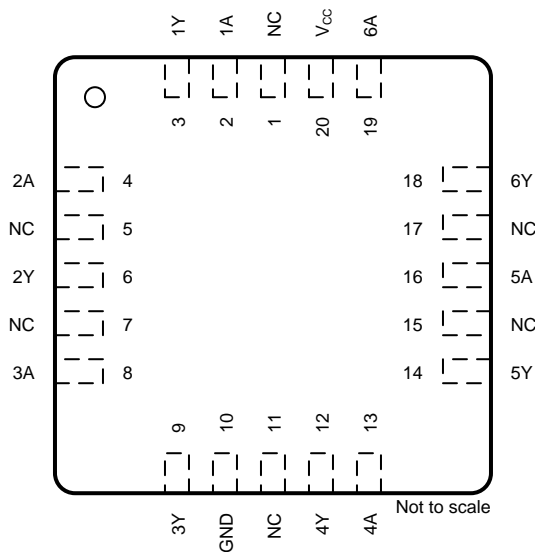

Not to scale

**SN54LVC04A, SN74LVC04A**

SCAS281T – JANUARY 1993 – REVISED NOVEMBER 2016

[www.ti.com](http://www.ti.com)
**Pin Functions**

PIN			I/O	DESCRIPTION
NAME	D, DB, DGV, J, NS, PW, RGY, W	FK, LCCC		
1A	1	2	I	Channel 1 input
1Y	2	3	O	Channel 1 output
2A	3	4	I	Channel 2 input
2Y	4	6	O	Channel 2 output
3A	5	8	I	Channel 3 input
3Y	6	9	O	Channel 3 output
4A	9	13	I	Channel 4 input
4Y	8	12	O	Channel 4 output
5A	11	16	I	Channel 5 input
5Y	10	14	O	Channel 5 output
6A	13	19	I	Channel 6 input
6Y	12	18	O	Channel 6 output
GND	7	10	—	Ground
NC	—	1, 5, 7, 11, 15, 17	—	No internal connection
V <sub>CC</sub>	14	20	—	Power supply

## 6 Specifications

### 6.1 Absolute Maximum Ratings

over operating free-air temperature range (unless otherwise noted)<sup>(1)</sup>

		MIN	MAX	UNIT
Supply voltage, $V_{CC}$		-0.5	6.5	V
Input voltage, $V_I$ <sup>(2)</sup>		-0.5	6.5	V
Output voltage, $V_O$ <sup>(2)(3)</sup>		-0.5	$V_{CC} + 0.5$	V
Input clamp current, $I_{IK}$	$V_I < 0$		-50	mA
Output clamp current, $I_{OK}$	$V_O < 0$		-50	mA
Continuous output current, $I_O$			±50	mA
Continuous current through $V_{CC}$ or GND			±100	mA
Power dissipation, $P_{tot}$	$T_A = -40^\circ\text{C}$ to $125^\circ\text{C}$ <sup>(4)(5)</sup>		500	mW
Maximum virtual junction temperature, $T_{J(MAX)}$			150	°C
Storage temperature, $T_{stg}$		-65	150	°C

- (1) Stresses beyond those listed under *Absolute Maximum Ratings* may cause permanent damage to the device. These are stress ratings only, which do not imply functional operation of the device at these or any other conditions beyond those indicated under *Recommended Operating Conditions*. Exposure to absolute-maximum-rated conditions for extended periods may affect device reliability.
- (2) The input and output negative-voltage ratings may be exceeded if the input and output current ratings are observed.
- (3) The value of  $V_{CC}$  is provided in [Recommended Operating Conditions](#).
- (4) For the D package: above  $70^\circ\text{C}$ , the value of  $P_{tot}$  derates linearly with 8 mW/K.
- (5) For the DB, DGV, NS, and PW packages: above  $60^\circ\text{C}$ , the value of  $P_{tot}$  derates linearly with 5.5 mW/K.

### 6.2 ESD Ratings

		VALUE	UNIT
$V_{(ESD)}$ Electrostatic discharge	Human-body model (HBM), per ANSI/ESDA/JEDEC JS-001 <sup>(1)</sup>	±2000	V
	Charged-device model (CDM), per JEDEC specification JESD22-C101 <sup>(2)</sup>	±1000	
	Machine Model (MM)	±200	

- (1) JEDEC document JEP155 states that 500-V HBM allows safe manufacturing with a standard ESD control process.
- (2) JEDEC document JEP157 states that 250-V CDM allows safe manufacturing with a standard ESD control process.

### 6.3 Recommended Operating Conditions

over operating free-air temperature range (unless otherwise noted)<sup>(1)</sup>

		MIN	MAX	UNIT	
$V_{CC}$ Supply voltage	Operating	SN54LVC04A	2	3.6	V
		SN74LVC04A	1.65	3.6	
	Data retention only		1.5		
$V_{IH}$ High-level input voltage	$V_{CC} = 1.65\text{ V}$ to $1.95\text{ V}$ , SN74LVC04A only		$0.65 \times V_{CC}$		V
	$V_{CC} = 2.3\text{ V}$ to $2.7\text{ V}$ , SN74LVC04A only		1.7		
	$V_{CC} = 2.7\text{ V}$ to $3.6\text{ V}$		2		
$V_{IL}$ Low-level input voltage	$V_{CC} = 1.65\text{ V}$ to $1.95\text{ V}$ , SN74LVC04A only		$0.35 \times V_{CC}$		V
	$V_{CC} = 2.3\text{ V}$ to $2.7\text{ V}$ , SN74LVC04A only		0.7		
	$V_{CC} = 2.7\text{ V}$ to $3.6\text{ V}$		0.8		
$V_I$ Input voltage			0	5.5	V
$V_O$ Output voltage			0	$V_{CC}$	V
$I_{OH}$ High-level output current	$V_{CC} = 1.65\text{ V}$ , SN74LVC04A only		-4		mA
	$V_{CC} = 2.3\text{ V}$ , SN74LVC04A only		-8		
	$V_{CC} = 2.7\text{ V}$		-12		
	$V_{CC} = 3\text{ V}$		-24		

- (1) All unused inputs of the device must be held at  $V_{CC}$  or GND to ensure proper device operation. See TI application report, [Implications of Slow or Floating CMOS Inputs](#) (SCBA004).

## Recommended Operating Conditions (continued)

 over operating free-air temperature range (unless otherwise noted)<sup>(1)</sup>

		MIN	MAX	UNIT
I <sub>OL</sub>	Low-level output current	V <sub>CC</sub> = 1.65 V, SN74LVC04A only	4	mA
		V <sub>CC</sub> = 2.3 V, SN74LVC04A only	8	
		V <sub>CC</sub> = 2.7 V	12	
		V <sub>CC</sub> = 3 V	24	

### 6.4 Thermal Information – SN54LVC04A

THERMAL METRIC <sup>(1)</sup>		SN54LVC04A			UNIT
		J (CDIP)	W (CFP)	FK (LCCC)	
		14 PINS	14 PINS	20 PINS	
R <sub>θJA</sub>	Junction-to-ambient thermal resistance	92	158.2	85	°C/W
R <sub>θJC(top)</sub>	Junction-to-case (top) thermal resistance	55.1	88.7	62.5	°C/W
R <sub>θJB</sub>	Junction-to-board thermal resistance	80.5	156.5	61.2	°C/W
Ψ <sub>JT</sub>	Junction-to-top characterization parameter	40.2	58.5	55.8	°C/W
Ψ <sub>JB</sub>	Junction-to-board characterization parameter	74.2	135.5	61.2	°C/W
R <sub>θJC(bot)</sub>	Junction-to-case (bottom) thermal resistance	25.3	15.3	10.4	°C/W

(1) For more information about traditional and new thermal metrics, see the [Semiconductor and IC Package Thermal Metrics](#) application report.

### 6.5 Thermal Information – SN74LVC04A

THERMAL METRIC <sup>(1)</sup>		SN74LVC04A						UNIT
		D (SOIC)	DB (SSOP)	DGV (TVSOP)	NS (SOP)	PW (TSSOP)	RGY (VQFN)	
		14 PINS	14 PINS	14 PINS	14 PINS	14 PINS	14 PINS	
R <sub>θJA</sub>	Junction-to-ambient thermal resistance	105.7	113.1	142.7	95.4	129.5	63.2	°C/W
R <sub>θJC(top)</sub>	Junction-to-case (top) thermal resistance	50.8	65.1	61.9	53.2	57.9	61	°C/W
R <sub>θJB</sub>	Junction-to-board thermal resistance	46.1	60.5	72.1	54.2	71.3	39.1	°C/W
Ψ <sub>JT</sub>	Junction-to-top characterization parameter	8.2	29.1	10.1	21.9	9.9	5.2	°C/W
Ψ <sub>JB</sub>	Junction-to-board characterization parameter	45.6	60	71.4	53.8	70.7	39.1	°C/W
R <sub>θJC(bot)</sub>	Junction-to-case (bottom) thermal resistance	—	—	—	—	—	20.3	°C/W

(1) For more information about traditional and new thermal metrics, see the [Semiconductor and IC Package Thermal Metrics](#) application report.

## 6.6 Electrical Characteristics – SN54LVC04A

over recommended operating free-air temperature range (unless otherwise noted)

PARAMETER		TEST CONDITIONS		MIN	TYP	MAX	UNIT
V <sub>OH</sub>	High-level output voltage	I <sub>OH</sub> = -100 µA, V <sub>CC</sub> = 2.7 V to 3.6 V		V <sub>CC</sub> - 0.2			V
		I <sub>OH</sub> = -12 mA	V <sub>CC</sub> = 2.7 V	2.2			
			V <sub>CC</sub> = 3 V	2.4			
		I <sub>OH</sub> = -24 mA, V <sub>CC</sub> = 3 V		2.2			
V <sub>OL</sub>	Low-level output voltage	I <sub>OL</sub> = 100 µA, V <sub>CC</sub> = 2.7 V to 3.6 V		0.2			V
		I <sub>OL</sub> = 12 mA, V <sub>CC</sub> = 2.7 V		0.4			
		I <sub>OL</sub> = 24 mA, V <sub>CC</sub> = 3 V		0.55			
I <sub>I</sub>	Input current	V <sub>I</sub> = 5.5 V or GND, V <sub>CC</sub> = 3.6 V		±5			µA
I <sub>CC</sub>	Supply current	V <sub>I</sub> = V <sub>CC</sub> or GND, I <sub>O</sub> = 0, V <sub>CC</sub> = 3.6 V		10			µA
ΔI <sub>CC</sub>	Change in supply current	One input at V <sub>CC</sub> - 0.6 V, Other inputs at V <sub>CC</sub> or GND, V <sub>CC</sub> = 2.7 V to 3.6 V		500			µA

## 6.7 Electrical Characteristics – SN74LVC04A

over recommended operating free-air temperature range (unless otherwise noted)

PARAMETER		TEST CONDITIONS		MIN	TYP	MAX	UNIT	
V <sub>OH</sub>	High-level output voltage	I <sub>OH</sub> = -100 µA, V <sub>CC</sub> = 1.65 V to 3.6 V	T <sub>A</sub> = 25°C	V <sub>CC</sub> - 0.2			V	
			T <sub>A</sub> = -40°C to 125°C	V <sub>CC</sub> - 0.3				
		I <sub>OH</sub> = -4 mA, V <sub>CC</sub> = 1.65 V	T <sub>A</sub> = 25°C	1.29				
			T <sub>A</sub> = -40°C to 85°C	1.2				
			T <sub>A</sub> = -40°C to 125°C	1.05				
		I <sub>OH</sub> = -8 mA, V <sub>CC</sub> = 2.3 V	T <sub>A</sub> = 25°C	1.9				
			T <sub>A</sub> = -40°C to 85°C	1.7				
			T <sub>A</sub> = -40°C to 125°C	1.55				
		I <sub>OH</sub> = -12 mA	V <sub>CC</sub> = 2.7 V	T <sub>A</sub> = 25°C	2.2			
				T <sub>A</sub> = -40°C to 125°C	2.05			
			V <sub>CC</sub> = 3 V	T <sub>A</sub> = 25°C	2.4			
				T <sub>A</sub> = -40°C to 125°C	2.25			
I <sub>OH</sub> = -24 mA, V <sub>CC</sub> = 3 V	T <sub>A</sub> = 25°C		2.3					
	T <sub>A</sub> = -40°C to 85°C		2.2					
	T <sub>A</sub> = -40°C to 125°C		2					
V <sub>OL</sub>	Low-level output voltage	I <sub>OL</sub> = 100 µA, V <sub>CC</sub> = 1.65 V to 3.6 V	T <sub>A</sub> = 25°C	0.1			V	
			T <sub>A</sub> = -40°C to 85°C	0.2				
			T <sub>A</sub> = -40°C to 125°C	0.3				
		I <sub>OL</sub> = 4 mA, V <sub>CC</sub> = 1.65 V	T <sub>A</sub> = 25°C		0.24			
			T <sub>A</sub> = -40°C to 85°C		0.45			
			T <sub>A</sub> = -40°C to 125°C		0.6			
		I <sub>OL</sub> = 8 mA, V <sub>CC</sub> = 2.3 V	T <sub>A</sub> = 25°C		0.3			
			T <sub>A</sub> = -40°C to 85°C		0.7			
			T <sub>A</sub> = -40°C to 125°C		0.85			
		I <sub>OL</sub> = 12 mA, V <sub>CC</sub> = 2.7 V	T <sub>A</sub> = 25°C		0.4			
			T <sub>A</sub> = -40°C to 125°C		0.6			
			T <sub>A</sub> = -40°C to 125°C		0.8			
I <sub>OL</sub> = 24 mA, V <sub>CC</sub> = 3 V	T <sub>A</sub> = 25°C		0.55					
	T <sub>A</sub> = -40°C to 125°C		0.8					
	T <sub>A</sub> = -40°C to 125°C		0.8					
I <sub>I</sub>	Input current	V <sub>I</sub> = 5.5 V or GND, V <sub>CC</sub> = 3.6 V	T <sub>A</sub> = 25°C	±1			µA	
			T <sub>A</sub> = -40°C to 85°C	±5				
			T <sub>A</sub> = -40°C to 125°C	±20				

## Electrical Characteristics – SN74LVC04A (continued)

over recommended operating free-air temperature range (unless otherwise noted)

PARAMETER	TEST CONDITIONS		MIN	TYP	MAX	UNIT
$I_{CC}$ Supply current	$V_I = V_{CC}$ or GND, $I_O = 0$ , $V_{CC} = 3.6$ V	$T_A = 25^\circ\text{C}$			1	$\mu\text{A}$
		$T_A = -40^\circ\text{C}$ to $85^\circ\text{C}$			10	
		$T_A = -40^\circ\text{C}$ to $125^\circ\text{C}$			40	
$\Delta I_{CC}$ Change in supply current	One input at $V_{CC} - 0.6$ V, other inputs at $V_{CC}$ or GND, $V_{CC} = 2.7$ V to $3.6$ V	$T_A = 25^\circ\text{C}$			500	$\mu\text{A}$
		$T_A = -40^\circ\text{C}$ to $125^\circ\text{C}$			5000	
$C_i$ Input capacitance	$V_I = V_{CC}$ or GND, $V_{CC} = 3.3$ V				5	pF

## 6.8 Switching Characteristics

 over recommended operating free-air temperature range (unless otherwise noted; see [Figure 2](#))

PARAMETER	TEST CONDITIONS		MIN	TYP	MAX	UNIT		
$t_{pd}$ Propagation (delay) time	From A (input) to Y (output)	$V_{CC} = 1.8$ V $\pm 0.15$ V, SN74LVC04A only	$T_A = 25^\circ\text{C}$	1	4.1	7.5	ns	
			$T_A = -40^\circ\text{C}$ to $85^\circ\text{C}$	1		8		
			$T_A = -40^\circ\text{C}$ to $125^\circ\text{C}$	1		9.5		
		$V_{CC} = 2.5$ V $\pm 0.2$ V, SN74LVC04A only	$T_A = 25^\circ\text{C}$	1	3.6	7		
			$T_A = -40^\circ\text{C}$ to $85^\circ\text{C}$	1		7.5		
			$T_A = -40^\circ\text{C}$ to $125^\circ\text{C}$	1		9		
		$V_{CC} = 2.7$ V	$T_A = -55^\circ\text{C}$ to $125^\circ\text{C}$ , SN54LVC04A			5.5		
			$T_A = 25^\circ\text{C}$ , SN74LVC04A	1	3	5.3		
			$T_A = -40^\circ\text{C}$ to $85^\circ\text{C}$ , SN74LVC04A	1		5.5		
			$T_A = -40^\circ\text{C}$ to $125^\circ\text{C}$ , SN74LVC04A	1		7		
			$V_{CC} = 3.3$ V $\pm 0.3$ V	$T_A = -55^\circ\text{C}$ to $125^\circ\text{C}$ , SN54LVC04A	0.5			4.5
				$T_A = 25^\circ\text{C}$ , SN74LVC04A	1	2.5		4.3
$T_A = -40^\circ\text{C}$ to $85^\circ\text{C}$ , SN74LVC04A	1			4.5				
$t_{sk(o)}$ Skew (time), output	$V_{CC} = 3.3$ V $\pm 0.3$ V, SN74LVC04A only	$T_A = -40^\circ\text{C}$ to $85^\circ\text{C}$			1	ns		
		$T_A = -40^\circ\text{C}$ to $125^\circ\text{C}$			1.5			

## 6.9 Operating Characteristics

 $T_A = 25^\circ\text{C}$  (unless otherwise noted)

PARAMETER	TEST CONDITIONS		MIN	TYP	MAX	UNIT
$C_{pd}$ Power dissipation capacitance per gate	$f = 10$ MHz, $T_A = 25^\circ\text{C}$	$V_{CC} = 1.8$ V		6		pF
		$V_{CC} = 2.5$ V		7		
		$V_{CC} = 3.3$ V		8		



### 6.10 Typical Characteristics

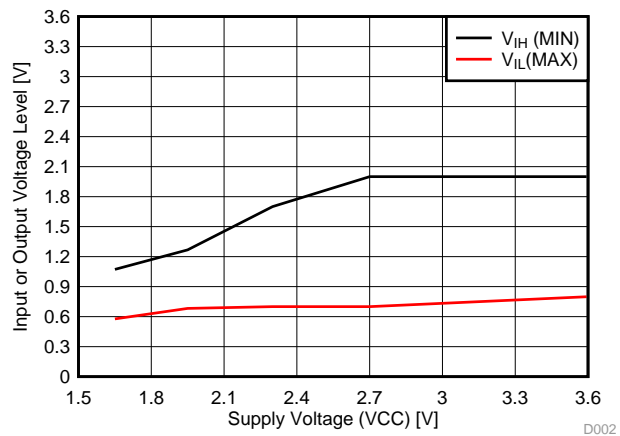

**Figure 1.  $V_{IH}$  Minimum and  $V_{IL}$  Maximum vs Supply Voltage**

## 7 Parameter Measurement Information

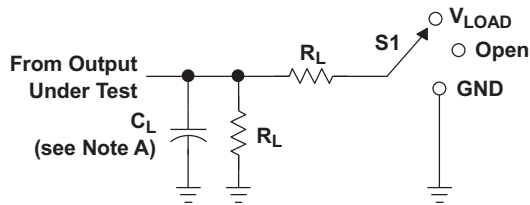
**LOAD CIRCUIT**

TEST	S1
$t_{PLH}/t_{PHL}$	Open
$t_{PLZ}/t_{PZL}$	$V_{LOAD}$
$t_{PHZ}/t_{PZH}$	GND

$V_{CC}$	INPUTS		$V_M$	$V_{LOAD}$	$C_L$	$R_L$	$V_{\Delta}$
	$V_I$	$t_r/t_f$					
$1.8\text{ V} \pm 0.15\text{ V}$	$V_{CC}$	$\leq 2\text{ ns}$	$V_{CC}/2$	$2 \times V_{CC}$	30 pF	1 k $\Omega$	0.15 V
$2.5\text{ V} \pm 0.2\text{ V}$	$V_{CC}$	$\leq 2\text{ ns}$	$V_{CC}/2$	$2 \times V_{CC}$	30 pF	500 $\Omega$	0.15 V
2.7 V	2.7 V	$\leq 2.5\text{ ns}$	1.5 V	6 V	50 pF	500 $\Omega$	0.3 V
$3.3\text{ V} \pm 0.3\text{ V}$	2.7 V	$\leq 2.5\text{ ns}$	1.5 V	6 V	50 pF	500 $\Omega$	0.3 V

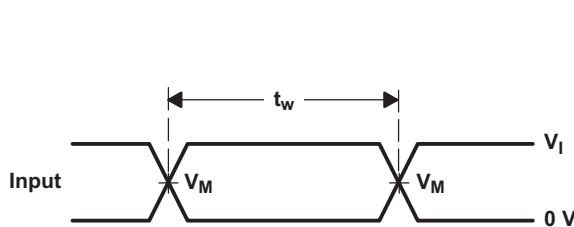
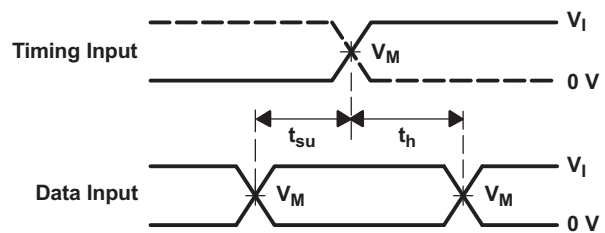
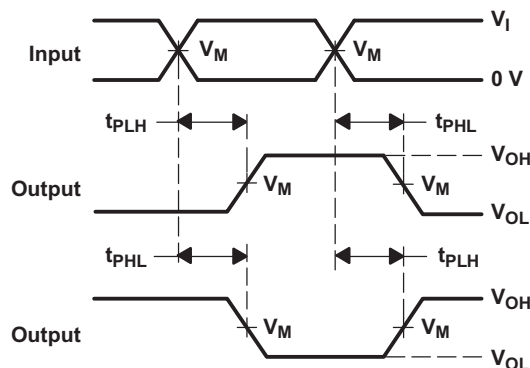
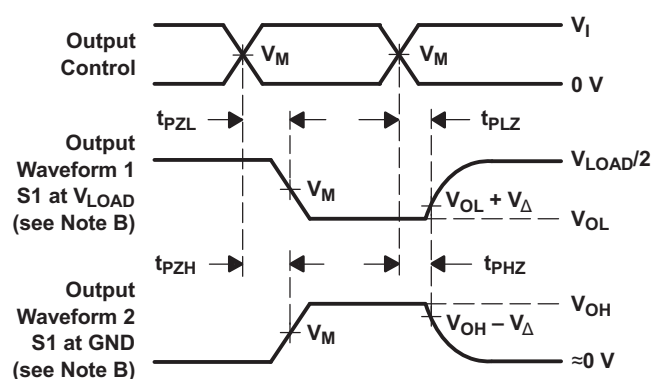
**VOLTAGE WAVEFORMS  
PULSE DURATION**

**VOLTAGE WAVEFORMS  
SETUP AND HOLD TIMES**

**VOLTAGE WAVEFORMS  
PROPAGATION DELAY TIMES  
INVERTING AND NONINVERTING OUTPUTS**

**VOLTAGE WAVEFORMS  
ENABLE AND DISABLE TIMES  
LOW- AND HIGH-LEVEL ENABLING**

- $C_L$  includes probe and jig capacitance.
- Waveform 1 is for an output with internal conditions such that the output is low, except when disabled by the output control. Waveform 2 is for an output with internal conditions such that the output is high, except when disabled by the output control.
- All input pulses are supplied by generators having the following characteristics:  $PRR \leq 10\text{ MHz}$ ,  $Z_O = 50\ \Omega$ .
- The outputs are measured one at a time, with one transition per measurement.
- $t_{PLZ}$  and  $t_{PHZ}$  are the same as  $t_{dis}$ .
- $t_{PZL}$  and  $t_{PZH}$  are the same as  $t_{en}$ .
- $t_{PLH}$  and  $t_{PHL}$  are the same as  $t_{pd}$ .
- All parameters and waveforms are not applicable to all devices.

**Figure 2. Load Circuit and Voltage Waveforms**

## 8 Detailed Description

### 8.1 Overview

These hex inverters are designed for 1.65-V to 3.6-V  $V_{CC}$  operation. The SN74LVC04A devices contain six independent inverters. These devices perform the Boolean function  $Y = \bar{A}$ . These devices are fully specified for partial-power-down applications using  $I_{OFF}$ . The  $I_{OFF}$  circuitry disables the outputs, preventing damaging current backflow through the devices when they are powered down. The inputs are high impedance when  $V_{CC} = 0V$ .

### 8.2 Functional Block Diagram

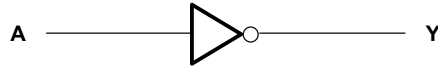

Copyright © 2016, Texas Instruments Incorporated

### 8.3 Feature Description

Wide operating voltage range from 1.65 V to 3.6 V. Allows down-voltage translation with inputs accept voltages to 3.6 V.  $I_{OFF}$  feature supports live insertion, partial power down mode, and back drive protection.

### 8.4 Device Functional Modes

[Table 1](#) lists the functional modes of the SNx4LVC04A.

**Table 1. Function Table  
(Each Inverter)**

INPUT A	OUTPUT Y
H	L
L	H

## 9 Application and Implementation

### NOTE

Information in the following applications sections is not part of the TI component specification, and TI does not warrant its accuracy or completeness. TI's customers are responsible for determining suitability of components for their purposes. Customers should validate and test their design implementation to confirm system functionality.

### 9.1 Application Information

SN74LVC04A is a low-drive CMOS device that can be used for a multitude of bus interface type applications where output ringing is a concern. The low drive and slow edge rates minimize overshoot and undershoot on the outputs. The inputs can accept voltages to 3.6 V at any valid  $V_{CC}$  making it ideal for down translation.

### 9.2 Typical Application

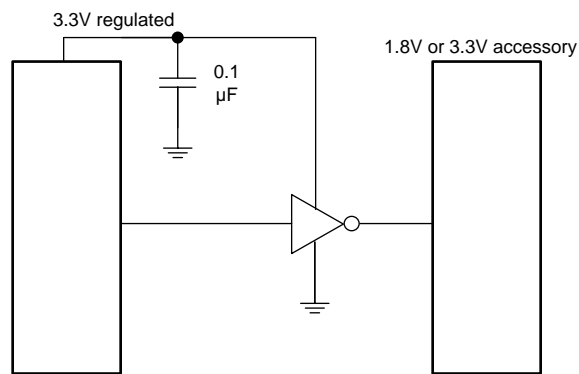

Copyright © 2016, Texas Instruments Incorporated

**Figure 3. Typical Application Schematic**

#### 9.2.1 Design Requirements

This device uses CMOS technology and has balanced output drive. Take care to avoid bus contention, because it can drive currents that would exceed maximum limits. The high drive also creates fast edges into light loads, so routing and load conditions must be considered to prevent ringing.

#### 9.2.2 Detailed Design Procedure

Recommended Input Conditions:

- For rise time and fall time specifications, see  $\Delta t/\Delta V$  in [Recommended Operating Conditions](#).
- For specified high and low levels, see  $V_{IH}$  and  $V_{IL}$  in [Recommended Operating Conditions](#).
- Inputs are overvoltage tolerant allowing them to go as high as 3.6 V at any valid  $V_{CC}$ .

Recommend Output Conditions:

- Load currents must not exceed 25 mA per output and 50 mA total for the part.
- Outputs must not be pulled above  $V_{CC}$ .

## Typical Application (continued)

### 9.2.3 Application Curves

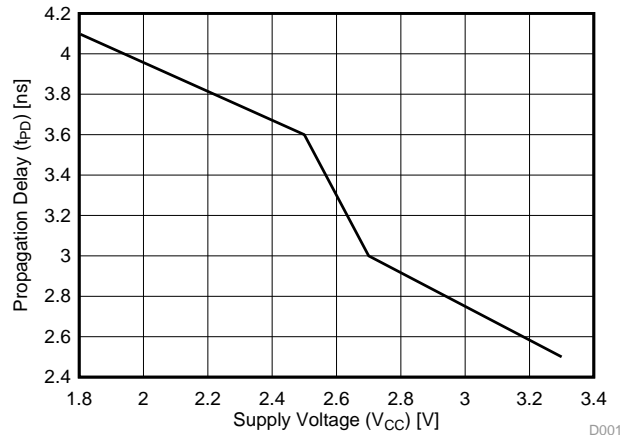

Figure 4. Typical Application Curve

## 10 Power Supply Recommendations

The power supply can be any voltage between the minimum and maximum supply voltage rating located in the [Recommended Operating Conditions](#).

Each V<sub>CC</sub> pin must have a good bypass capacitor to prevent power disturbance. For devices with a single supply, 0.1 μF is recommended. If there are multiple V<sub>CC</sub> pins, 0.01 μF or 0.022 μF is recommended for each power pin. It is acceptable to parallel multiple bypass caps to reject different frequencies of noise. A 0.1 μF and 1 μF are commonly used in parallel. The bypass capacitor must be installed as close to the power pin as possible for best results.

## 11 Layout

### 11.1 Layout Guidelines

When using multiple bit logic devices, inputs must not float. In many cases, functions or parts of functions of digital logic devices are unused. Some examples are when only two inputs of a triple-input AND gate are used, or when only 3 of the 4-buffer gates are used. Such input pins must not be left unconnected because the undefined voltages at the outside connections result in undefined operational states.

Specified in [Figure 5](#) are rules that must be observed under all circumstances. All unused inputs of digital logic devices must be connected to a high or low bias to prevent them from floating. The logic level that must be applied to any particular unused input depends on the function of the device. Generally they are tied to GND or V<sub>CC</sub>, whichever makes more sense or is more convenient. It is acceptable to float outputs unless the part is a transceiver. If the transceiver has an output enable pin, it disables the outputs section of the part when asserted. This does not disable the input section of the I/Os so they also cannot float when disabled.

### 11.2 Layout Example

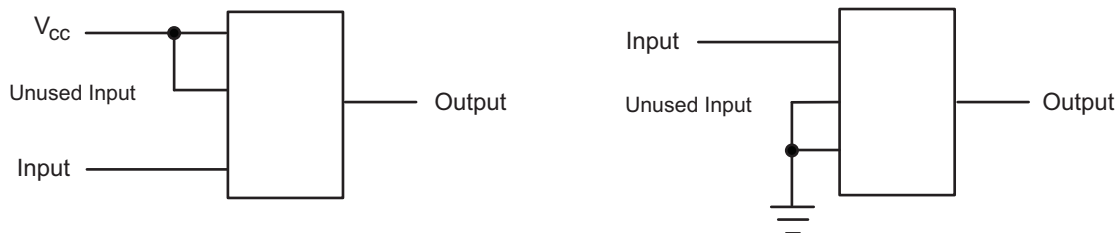

Figure 5. Layout Diagram

## 12 Device and Documentation Support

### 12.1 Documentation Support

#### 12.1.1 Related Documentation

For related documentation see the following:

[Implications of Slow or Floating CMOS Inputs](#) (SCBA004)

### 12.2 Related Links

The table below lists quick access links. Categories include technical documents, support and community resources, tools and software, and quick access to sample or buy.

Table 2. Related Links

PARTS	PRODUCT FOLDER	SAMPLE & BUY	TECHNICAL DOCUMENTS	TOOLS & SOFTWARE	SUPPORT & COMMUNITY
SN54LVC04A	<a href="#">Click here</a>	<a href="#">Click here</a>	<a href="#">Click here</a>	<a href="#">Click here</a>	<a href="#">Click here</a>
SN74LVC04A	<a href="#">Click here</a>	<a href="#">Click here</a>	<a href="#">Click here</a>	<a href="#">Click here</a>	<a href="#">Click here</a>

### 12.3 Receiving Notification of Documentation Updates

To receive notification of documentation updates, navigate to the device product folder on ti.com. In the upper right corner, click on *Alert me* to register and receive a weekly digest of any product information that has changed. For change details, review the revision history included in any revised document.

### 12.4 Community Resources

The following links connect to TI community resources. Linked contents are provided "AS IS" by the respective contributors. They do not constitute TI specifications and do not necessarily reflect TI's views; see TI's [Terms of Use](#).

**TI E2E™ Online Community** *TI's Engineer-to-Engineer (E2E) Community*. Created to foster collaboration among engineers. At e2e.ti.com, you can ask questions, share knowledge, explore ideas and help solve problems with fellow engineers.

**Design Support** *TI's Design Support* Quickly find helpful E2E forums along with design support tools and contact information for technical support.

### 12.5 Trademarks

E2E is a trademark of Texas Instruments. All other trademarks are the property of their respective owners.

### 12.6 Electrostatic Discharge Caution



These devices have limited built-in ESD protection. The leads should be shorted together or the device placed in conductive foam during storage or handling to prevent electrostatic damage to the MOS gates.

### 12.7 Glossary

[SLYZ022](#) — *TI Glossary*.

This glossary lists and explains terms, acronyms, and definitions.

## 13 Mechanical, Packaging, and Orderable Information

The following pages include mechanical, packaging, and orderable information. This information is the most current data available for the designated devices. This data is subject to change without notice and revision of this document. For browser-based versions of this data sheet, refer to the left-hand navigation.

**PACKAGING INFORMATION**

Orderable Device	Status (1)	Package Type	Package Drawing	Pins	Package Qty	Eco Plan (2)	Lead finish/ Ball material (6)	MSL Peak Temp (3)	Op Temp (°C)	Device Marking (4/5)	Samples
5962-9760501Q2A	ACTIVE	LCCC	FK	20	55	Non-RoHS & Green	SNPB	N / A for Pkg Type	-55 to 125	5962-9760501Q2A SNJ54LVC04AFK	<a href="#">Samples</a>
5962-9760501QCA	ACTIVE	CDIP	J	14	25	Non-RoHS & Green	SNPB	N / A for Pkg Type	-55 to 125	5962-9760501QC A SNJ54LVC04AJ	<a href="#">Samples</a>
5962-9760501QDA	ACTIVE	CFP	W	14	25	Non-RoHS & Green	SNPB	N / A for Pkg Type	-55 to 125	5962-9760501QD A SNJ54LVC04AW	<a href="#">Samples</a>
SN74LVC04AD	ACTIVE	SOIC	D	14	50	RoHS & Green	NIPDAU	Level-1-260C-UNLIM	-40 to 125	LVC04A	<a href="#">Samples</a>
SN74LVC04ADBR	ACTIVE	SSOP	DB	14	2000	RoHS & Green	NIPDAU	Level-1-260C-UNLIM	-40 to 125	LC04A	<a href="#">Samples</a>
SN74LVC04ADBRG4	ACTIVE	SSOP	DB	14	2000	RoHS & Green	NIPDAU	Level-1-260C-UNLIM	-40 to 125	LC04A	<a href="#">Samples</a>
SN74LVC04ADGVR	ACTIVE	TVSOP	DGV	14	2000	RoHS & Green	NIPDAU	Level-1-260C-UNLIM	-40 to 125	LC04A	<a href="#">Samples</a>
SN74LVC04ADGVRE4	ACTIVE	TVSOP	DGV	14	2000	RoHS & Green	NIPDAU	Level-1-260C-UNLIM	-40 to 125	LC04A	<a href="#">Samples</a>
SN74LVC04ADR	ACTIVE	SOIC	D	14	2500	RoHS & Green	NIPDAU   SN	Level-1-260C-UNLIM	-40 to 125	LVC04A	<a href="#">Samples</a>
SN74LVC04ADRG3	ACTIVE	SOIC	D	14	2500	RoHS & Green	SN	Level-1-260C-UNLIM	-40 to 125	LVC04A	<a href="#">Samples</a>
SN74LVC04ADRG4	ACTIVE	SOIC	D	14	2500	RoHS & Green	NIPDAU	Level-1-260C-UNLIM	-40 to 125	LVC04A	<a href="#">Samples</a>
SN74LVC04ADT	ACTIVE	SOIC	D	14	250	RoHS & Green	NIPDAU	Level-1-260C-UNLIM	-40 to 125	LVC04A	<a href="#">Samples</a>
SN74LVC04ANSR	ACTIVE	SOP	NS	14	2000	RoHS & Green	NIPDAU	Level-1-260C-UNLIM	-40 to 125	LVC04A	<a href="#">Samples</a>
SN74LVC04APW	ACTIVE	TSSOP	PW	14	90	RoHS & Green	NIPDAU	Level-1-260C-UNLIM	-40 to 125	LC04A	<a href="#">Samples</a>
SN74LVC04APWE4	ACTIVE	TSSOP	PW	14	90	RoHS & Green	NIPDAU	Level-1-260C-UNLIM	-40 to 125	LC04A	<a href="#">Samples</a>
SN74LVC04APWG4	ACTIVE	TSSOP	PW	14	90	RoHS & Green	NIPDAU	Level-1-260C-UNLIM	-40 to 125	LC04A	<a href="#">Samples</a>
SN74LVC04APWR	ACTIVE	TSSOP	PW	14	2000	RoHS & Green	NIPDAU   SN	Level-1-260C-UNLIM	-40 to 125	LC04A	<a href="#">Samples</a>

Orderable Device	Status (1)	Package Type	Package Drawing	Pins	Package Qty	Eco Plan (2)	Lead finish/ Ball material (6)	MSL Peak Temp (3)	Op Temp (°C)	Device Marking (4/5)	Samples
SN74LVC04APWRE4	ACTIVE	TSSOP	PW	14	2000	RoHS & Green	NIPDAU	Level-1-260C-UNLIM	-40 to 125	LC04A	<a href="#">Samples</a>
SN74LVC04APWRG3	ACTIVE	TSSOP	PW	14	2000	RoHS & Green	SN	Level-1-260C-UNLIM	-40 to 125	LC04A	<a href="#">Samples</a>
SN74LVC04APWRG4	ACTIVE	TSSOP	PW	14	2000	RoHS & Green	NIPDAU	Level-1-260C-UNLIM	-40 to 125	LC04A	<a href="#">Samples</a>
SN74LVC04APWT	ACTIVE	TSSOP	PW	14	250	RoHS & Green	NIPDAU	Level-1-260C-UNLIM	-40 to 125	LC04A	<a href="#">Samples</a>
SN74LVC04APWTG4	ACTIVE	TSSOP	PW	14	250	RoHS & Green	NIPDAU	Level-1-260C-UNLIM	-40 to 125	LC04A	<a href="#">Samples</a>
SN74LVC04ARGYR	ACTIVE	VQFN	RGY	14	3000	RoHS & Green	NIPDAU	Level-2-260C-1 YEAR	-40 to 125	LC04A	<a href="#">Samples</a>
SN74LVC04ARGYRG4	ACTIVE	VQFN	RGY	14	3000	RoHS & Green	NIPDAU	Level-2-260C-1 YEAR	-40 to 125	LC04A	<a href="#">Samples</a>
SNJ54LVC04AFK	ACTIVE	LCCC	FK	20	55	Non-RoHS & Green	SNPB	N / A for Pkg Type	-55 to 125	5962- 9760501Q2A SNJ54LVC 04AFK	<a href="#">Samples</a>
SNJ54LVC04AJ	ACTIVE	CDIP	J	14	25	Non-RoHS & Green	SNPB	N / A for Pkg Type	-55 to 125	5962-9760501QC A SNJ54LVC04AJ	<a href="#">Samples</a>
SNJ54LVC04AW	ACTIVE	CFP	W	14	25	Non-RoHS & Green	SNPB	N / A for Pkg Type	-55 to 125	5962-9760501QD A SNJ54LVC04AW	<a href="#">Samples</a>

(1) The marketing status values are defined as follows:

**ACTIVE:** Product device recommended for new designs.

**LIFEBUY:** TI has announced that the device will be discontinued, and a lifetime-buy period is in effect.

**NRND:** Not recommended for new designs. Device is in production to support existing customers, but TI does not recommend using this part in a new design.

**PREVIEW:** Device has been announced but is not in production. Samples may or may not be available.

**OBSELETE:** TI has discontinued the production of the device.

(2) **RoHS:** TI defines "RoHS" to mean semiconductor products that are compliant with the current EU RoHS requirements for all 10 RoHS substances, including the requirement that RoHS substance do not exceed 0.1% by weight in homogeneous materials. Where designed to be soldered at high temperatures, "RoHS" products are suitable for use in specified lead-free processes. TI may reference these types of products as "Pb-Free".

**RoHS Exempt:** TI defines "RoHS Exempt" to mean products that contain lead but are compliant with EU RoHS pursuant to a specific EU RoHS exemption.

**Green:** TI defines "Green" to mean the content of Chlorine (Cl) and Bromine (Br) based flame retardants meet JS709B low halogen requirements of <=100ppm threshold. Antimony trioxide based flame retardants must also meet the <=1000ppm threshold requirement.

(3) MSL, Peak Temp. - The Moisture Sensitivity Level rating according to the JEDEC industry standard classifications, and peak solder temperature.



(4) There may be additional marking, which relates to the logo, the lot trace code information, or the environmental category on the device.

(5) Multiple Device Markings will be inside parentheses. Only one Device Marking contained in parentheses and separated by a "~" will appear on a device. If a line is indented then it is a continuation of the previous line and the two combined represent the entire Device Marking for that device.

(6) Lead finish/Ball material - Orderable Devices may have multiple material finish options. Finish options are separated by a vertical ruled line. Lead finish/Ball material values may wrap to two lines if the finish value exceeds the maximum column width.

**Important Information and Disclaimer:**The information provided on this page represents TI's knowledge and belief as of the date that it is provided. TI bases its knowledge and belief on information provided by third parties, and makes no representation or warranty as to the accuracy of such information. Efforts are underway to better integrate information from third parties. TI has taken and continues to take reasonable steps to provide representative and accurate information but may not have conducted destructive testing or chemical analysis on incoming materials and chemicals. TI and TI suppliers consider certain information to be proprietary, and thus CAS numbers and other limited information may not be available for release.

In no event shall TI's liability arising out of such information exceed the total purchase price of the TI part(s) at issue in this document sold by TI to Customer on an annual basis.

**OTHER QUALIFIED VERSIONS OF SN54LVC04A, SN74LVC04A :**

- Catalog : [SN74LVC04A](#)
- Automotive : [SN74LVC04A-Q1](#), [SN74LVC04A-Q1](#)
- Enhanced Product : [SN74LVC04A-EP](#), [SN74LVC04A-EP](#)
- Military : [SN54LVC04A](#)

NOTE: Qualified Version Definitions:

- Catalog - TI's standard catalog product
- Automotive - Q100 devices qualified for high-reliability automotive applications targeting zero defects
- Enhanced Product - Supports Defense, Aerospace and Medical Applications
- Military - QML certified for Military and Defense Applications

**TAPE AND REEL INFORMATION**

**QUADRANT ASSIGNMENTS FOR PIN 1 ORIENTATION IN TAPE**



\*All dimensions are nominal

Device	Package Type	Package Drawing	Pins	SPQ	Reel Diameter (mm)	Reel Width W1 (mm)	A0 (mm)	B0 (mm)	K0 (mm)	P1 (mm)	W (mm)	Pin1 Quadrant
SN74LVC04ADBR	SSOP	DB	14	2000	330.0	16.4	8.35	6.6	2.4	12.0	16.0	Q1
SN74LVC04ADGVR	TVSOP	DGV	14	2000	330.0	12.4	6.8	4.0	1.6	8.0	12.0	Q1
SN74LVC04ADR	SOIC	D	14	2500	330.0	16.4	6.5	9.0	2.1	8.0	16.0	Q1
SN74LVC04ADRG3	SOIC	D	14	2500	330.0	16.8	6.5	9.5	2.1	8.0	16.0	Q1
SN74LVC04ADRG4	SOIC	D	14	2500	330.0	16.4	6.5	9.0	2.1	8.0	16.0	Q1
SN74LVC04ADRG4	SOIC	D	14	2500	330.0	16.4	6.5	9.0	2.1	8.0	16.0	Q1
SN74LVC04ADT	SOIC	D	14	250	330.0	16.4	6.5	9.0	2.1	8.0	16.0	Q1
SN74LVC04ANSR	SOP	NS	14	2000	330.0	16.4	8.2	10.5	2.5	12.0	16.0	Q1
SN74LVC04APWR	TSSOP	PW	14	2000	330.0	12.4	6.9	5.6	1.6	8.0	12.0	Q1
SN74LVC04APWRG3	TSSOP	PW	14	2000	330.0	12.4	6.9	5.6	1.6	8.0	12.0	Q1
SN74LVC04APWRG4	TSSOP	PW	14	2000	330.0	12.4	6.9	5.6	1.6	8.0	12.0	Q1
SN74LVC04APWT	TSSOP	PW	14	250	330.0	12.4	6.9	5.6	1.6	8.0	12.0	Q1
SN74LVC04ARGYR	VQFN	RGY	14	3000	330.0	12.4	3.75	3.75	1.15	8.0	12.0	Q1

**TAPE AND REEL BOX DIMENSIONS**

\*All dimensions are nominal

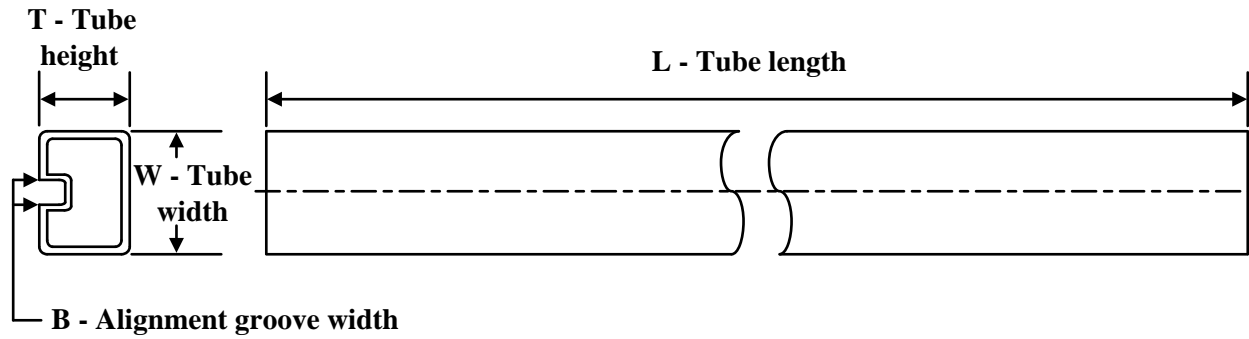
Device	Package Type	Package Drawing	Pins	SPQ	Length (mm)	Width (mm)	Height (mm)
SN74LVC04ADBR	SSOP	DB	14	2000	356.0	356.0	35.0
SN74LVC04ADGVR	TVSOP	DGV	14	2000	356.0	356.0	35.0
SN74LVC04ADR	SOIC	D	14	2500	353.0	353.0	32.0
SN74LVC04ADRG3	SOIC	D	14	2500	364.0	364.0	27.0
SN74LVC04ADRG4	SOIC	D	14	2500	340.5	336.1	32.0
SN74LVC04ADRG4	SOIC	D	14	2500	356.0	356.0	35.0
SN74LVC04ADT	SOIC	D	14	250	210.0	185.0	35.0
SN74LVC04ANSR	SOP	NS	14	2000	356.0	356.0	35.0
SN74LVC04APWR	TSSOP	PW	14	2000	356.0	356.0	35.0
SN74LVC04APWRG3	TSSOP	PW	14	2000	364.0	364.0	27.0
SN74LVC04APWRG4	TSSOP	PW	14	2000	356.0	356.0	35.0
SN74LVC04APWT	TSSOP	PW	14	250	356.0	356.0	35.0
SN74LVC04ARGYR	VQFN	RGY	14	3000	356.0	356.0	35.0

**TUBE**

\*All dimensions are nominal

Device	Package Name	Package Type	Pins	SPQ	L (mm)	W (mm)	T (μm)	B (mm)
5962-9760501Q2A	FK	LCCC	20	55	506.98	12.06	2030	NA
5962-9760501QDA	W	CFP	14	25	506.98	26.16	6220	NA
SN74LVC04AD	D	SOIC	14	50	507	8	3940	4.32
SN74LVC04AD	D	SOIC	14	50	506.6	8	3940	4.32
SN74LVC04APW	PW	TSSOP	14	90	530	10.2	3600	3.5
SN74LVC04APWE4	PW	TSSOP	14	90	530	10.2	3600	3.5
SN74LVC04APWG4	PW	TSSOP	14	90	530	10.2	3600	3.5
SNJ54LVC04AFK	FK	LCCC	20	55	506.98	12.06	2030	NA
SNJ54LVC04AW	W	CFP	14	25	506.98	26.16	6220	NA



# D0014A

# PACKAGE OUTLINE

## SOIC - 1.75 mm max height

SMALL OUTLINE INTEGRATED CIRCUIT



4220718/A 09/2016

### NOTES:

1. All linear dimensions are in millimeters. Dimensions in parenthesis are for reference only. Dimensioning and tolerancing per ASME Y14.5M.
2. This drawing is subject to change without notice.
3. This dimension does not include mold flash, protrusions, or gate burrs. Mold flash, protrusions, or gate burrs shall not exceed 0.15 mm, per side.
4. This dimension does not include interlead flash. Interlead flash shall not exceed 0.43 mm, per side.
5. Reference JEDEC registration MS-012, variation AB.

# EXAMPLE BOARD LAYOUT

D0014A

SOIC - 1.75 mm max height

SMALL OUTLINE INTEGRATED CIRCUIT



LAND PATTERN EXAMPLE  
SCALE:8X



SOLDER MASK DETAILS

4220718/A 09/2016

NOTES: (continued)

- 6. Publication IPC-7351 may have alternate designs.
- 7. Solder mask tolerances between and around signal pads can vary based on board fabrication site.

# EXAMPLE STENCIL DESIGN

D0014A

SOIC - 1.75 mm max height

SMALL OUTLINE INTEGRATED CIRCUIT



SOLDER PASTE EXAMPLE  
BASED ON 0.125 mm THICK STENCIL  
SCALE:8X

4220718/A 09/2016

NOTES: (continued)

8. Laser cutting apertures with trapezoidal walls and rounded corners may offer better paste release. IPC-7525 may have alternate design recommendations.
9. Board assembly site may have different recommendations for stencil design.

# MECHANICAL DATA

NS (R-PDSO-G\*\*)

PLASTIC SMALL-OUTLINE PACKAGE

14-PINS SHOWN



- NOTES:
- A. All linear dimensions are in millimeters.
  - B. This drawing is subject to change without notice.
  - C. Body dimensions do not include mold flash or protrusion, not to exceed 0,15.



W (R-GDFP-F14)

CERAMIC DUAL FLATPACK



- NOTES:
- A. All linear dimensions are in inches (millimeters).
  - B. This drawing is subject to change without notice.
  - C. This package can be hermetically sealed with a ceramic lid using glass frit.
  - D. Index point is provided on cap for terminal identification only.
  - E. Falls within MIL STD 1835 GDFP1-F14

DGV (R-PDSO-G\*\*)

PLASTIC SMALL-OUTLINE

24 PINS SHOWN



- NOTES: A. All linear dimensions are in millimeters.  
 B. This drawing is subject to change without notice.  
 C. Body dimensions do not include mold flash or protrusion, not to exceed 0,15 per side.  
 D. Falls within JEDEC: 24/48 Pins – MO-153  
 14/16/20/56 Pins – MO-194

# DB0014A



# PACKAGE OUTLINE

## SSOP - 2 mm max height

SMALL OUTLINE PACKAGE



**NOTES:**

1. All linear dimensions are in millimeters. Any dimensions in parenthesis are for reference only. Dimensioning and tolerancing per ASME Y14.5M.
2. This drawing is subject to change without notice.
3. This dimension does not include mold flash, protrusions, or gate burrs. Mold flash, protrusions, or gate burrs shall not exceed 0.15 mm per side.
4. Reference JEDEC registration MO-150.

# EXAMPLE BOARD LAYOUT

DB0014A

SSOP - 2 mm max height

SMALL OUTLINE PACKAGE



LAND PATTERN EXAMPLE  
EXPOSED METAL SHOWN  
SCALE: 10X



4220762/A 05/2024

NOTES: (continued)

- 5. Publication IPC-7351 may have alternate designs.
- 6. Solder mask tolerances between and around signal pads can vary based on board fabrication site.

# EXAMPLE STENCIL DESIGN

DB0014A

SSOP - 2 mm max height

SMALL OUTLINE PACKAGE



SOLDER PASTE EXAMPLE  
BASED ON 0.125 mm THICK STENCIL  
SCALE: 10X

4220762/A 05/2024

NOTES: (continued)

7. Laser cutting apertures with trapezoidal walls and rounded corners may offer better paste release. IPC-7525 may have alternate design recommendations.
8. Board assembly site may have different recommendations for stencil design.

## GENERIC PACKAGE VIEW

**FK 20**

**LCCC - 2.03 mm max height**

8.89 x 8.89, 1.27 mm pitch

LEADLESS CERAMIC CHIP CARRIER

This image is a representation of the package family, actual package may vary.  
Refer to the product data sheet for package details.



4229370VA\

J 14

**GENERIC PACKAGE VIEW**  
**CDIP - 5.08 mm max height**  
CERAMIC DUAL IN LINE PACKAGE



Images above are just a representation of the package family, actual package may vary.  
Refer to the product data sheet for package details.

4040083-5/G

J0014A



# PACKAGE OUTLINE

CDIP - 5.08 mm max height

CERAMIC DUAL IN LINE PACKAGE



4214771/A 05/2017

**NOTES:**

1. All controlling linear dimensions are in inches. Dimensions in brackets are in millimeters. Any dimension in brackets or parenthesis are for reference only. Dimensioning and tolerancing per ASME Y14.5M.
2. This drawing is subject to change without notice.
3. This package is hermetically sealed with a ceramic lid using glass frit.
4. Index point is provided on cap for terminal identification only and on press ceramic glass frit seal only.
5. Falls within MIL-STD-1835 and GDIP1-T14.



# EXAMPLE BOARD LAYOUT

J0014A

CDIP - 5.08 mm max height

CERAMIC DUAL IN LINE PACKAGE



LAND PATTERN EXAMPLE  
NON-SOLDER MASK DEFINED  
SCALE: 5X



4214771/A 05/2017

PW0014A



**PACKAGE OUTLINE**  
**TSSOP - 1.2 mm max height**

SMALL OUTLINE PACKAGE



4220202/B 12/2023

NOTES:

1. All linear dimensions are in millimeters. Any dimensions in parenthesis are for reference only. Dimensioning and tolerancing per ASME Y14.5M.
2. This drawing is subject to change without notice.
3. This dimension does not include mold flash, protrusions, or gate burrs. Mold flash, protrusions, or gate burrs shall not exceed 0.15 mm per side.
4. This dimension does not include interlead flash. Interlead flash shall not exceed 0.25 mm per side.
5. Reference JEDEC registration MO-153.

# EXAMPLE BOARD LAYOUT

PW0014A

TSSOP - 1.2 mm max height

SMALL OUTLINE PACKAGE



LAND PATTERN EXAMPLE  
EXPOSED METAL SHOWN  
SCALE: 10X



4220202/B 12/2023

NOTES: (continued)

- 6. Publication IPC-7351 may have alternate designs.
- 7. Solder mask tolerances between and around signal pads can vary based on board fabrication site.

# EXAMPLE STENCIL DESIGN

PW0014A

TSSOP - 1.2 mm max height

SMALL OUTLINE PACKAGE



SOLDER PASTE EXAMPLE  
BASED ON 0.125 mm THICK STENCIL  
SCALE: 10X

4220202/B 12/2023

NOTES: (continued)

8. Laser cutting apertures with trapezoidal walls and rounded corners may offer better paste release. IPC-7525 may have alternate design recommendations.
9. Board assembly site may have different recommendations for stencil design.

## GENERIC PACKAGE VIEW

**RGY 14**

**VQFN - 1 mm max height**

3.5 x 3.5, 0.5 mm pitch

PLASTIC QUAD FLATPACK - NO LEAD

This image is a representation of the package family, actual package may vary.  
Refer to the product data sheet for package details.

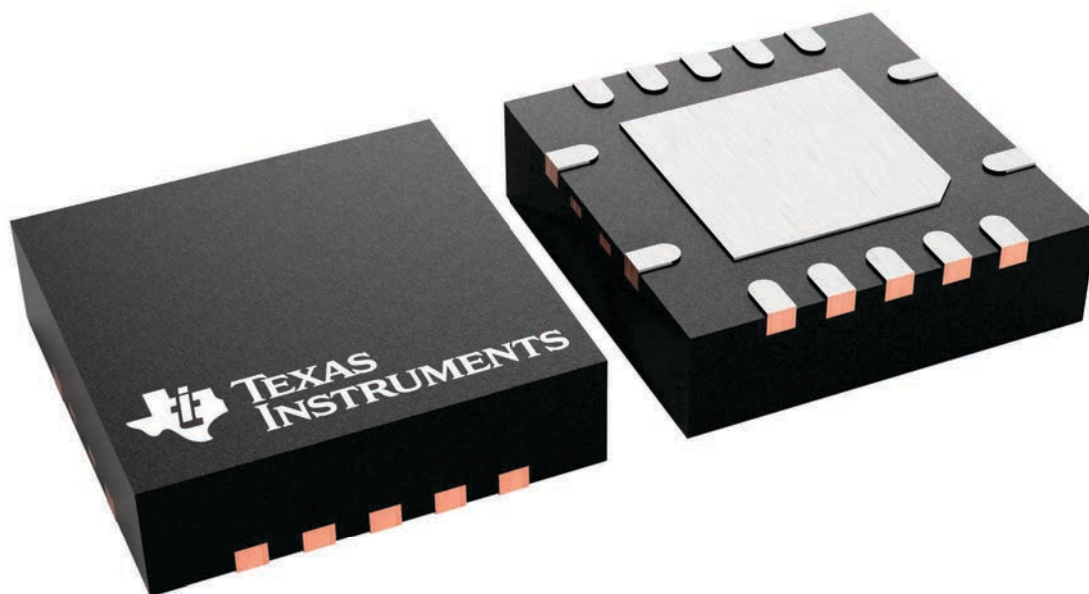

4231541/A

RGY0014A

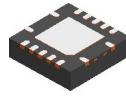

PACKAGE OUTLINE

VQFN - 1 mm max height

PLASTIC QUAD FLATPACK - NO LEAD

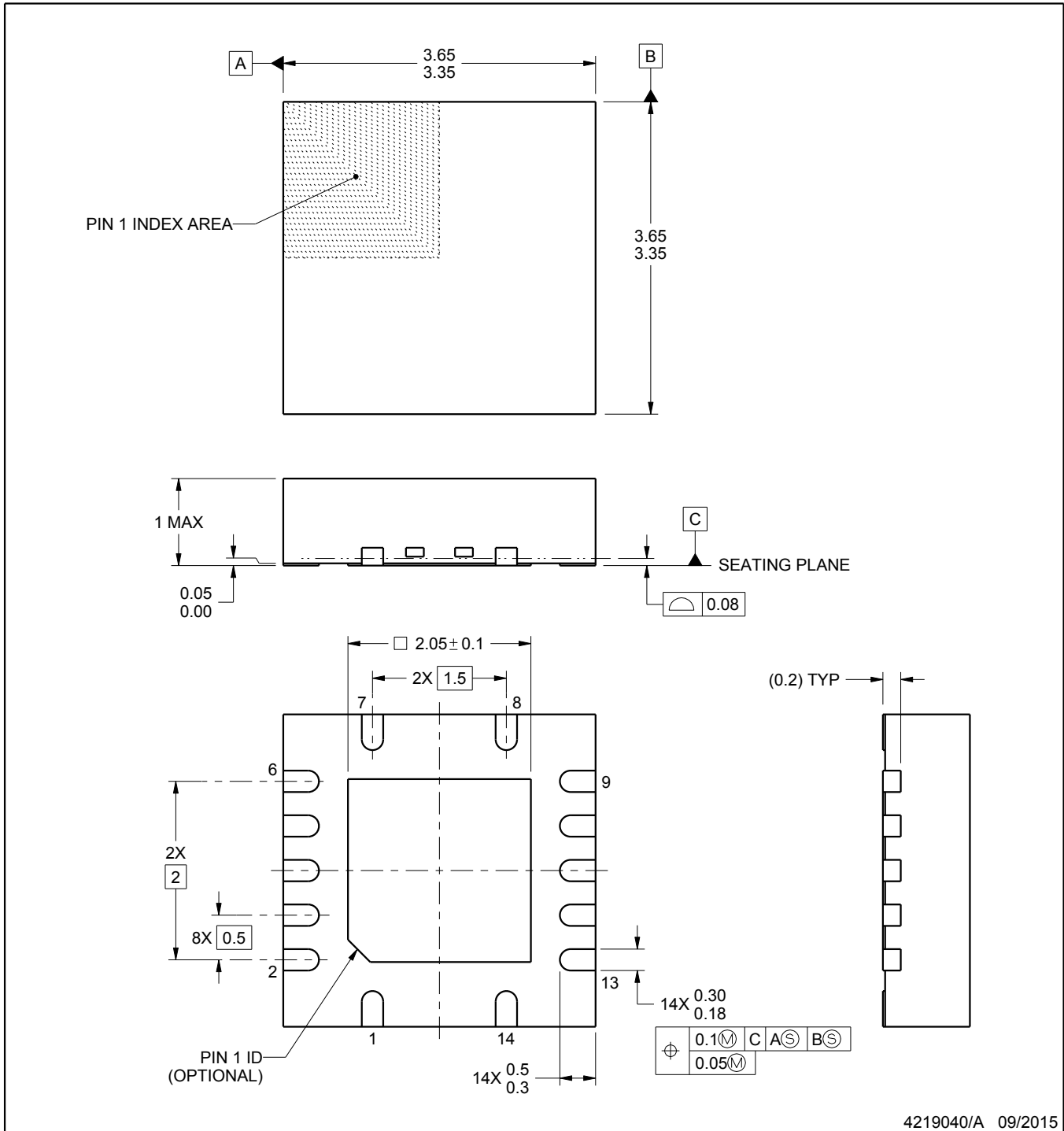

4219040/A 09/2015

NOTES:

1. All linear dimensions are in millimeters. Any dimensions in parenthesis are for reference only. Dimensioning and tolerancing per ASME Y14.5M.
2. This drawing is subject to change without notice.
3. The package thermal pad must be soldered to the printed circuit board for thermal and mechanical performance.

# EXAMPLE BOARD LAYOUT

RGY0014A

VQFN - 1 mm max height

PLASTIC QUAD FLATPACK - NO LEAD

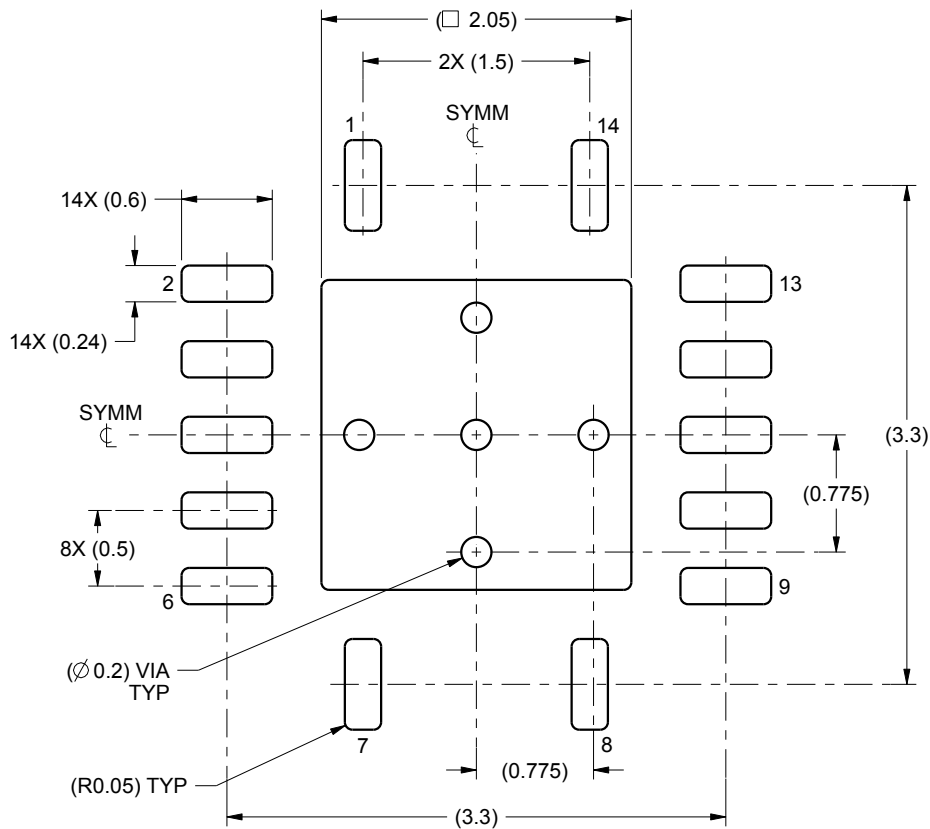

LAND PATTERN EXAMPLE  
SCALE:20X

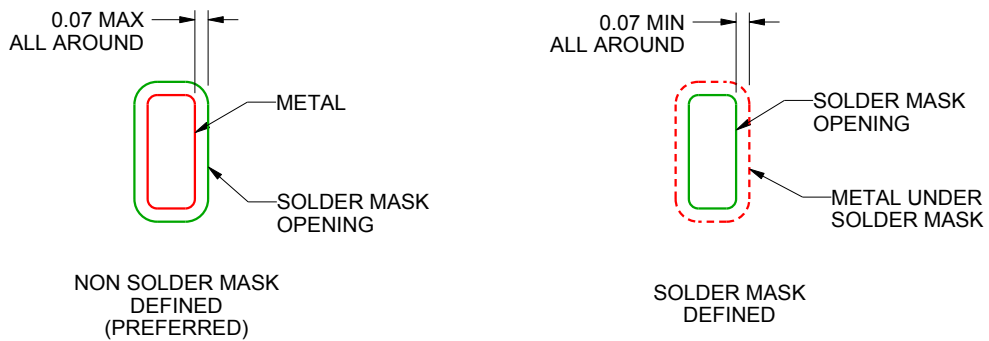

SOLDER MASK DETAILS

4219040/A 09/2015

NOTES: (continued)

4. This package is designed to be soldered to a thermal pad on the board. For more information, see Texas Instruments literature number SLUA271 ([www.ti.com/lit/slua271](http://www.ti.com/lit/slua271)).

# EXAMPLE STENCIL DESIGN

RGY0014A

VQFN - 1 mm max height

PLASTIC QUAD FLATPACK - NO LEAD

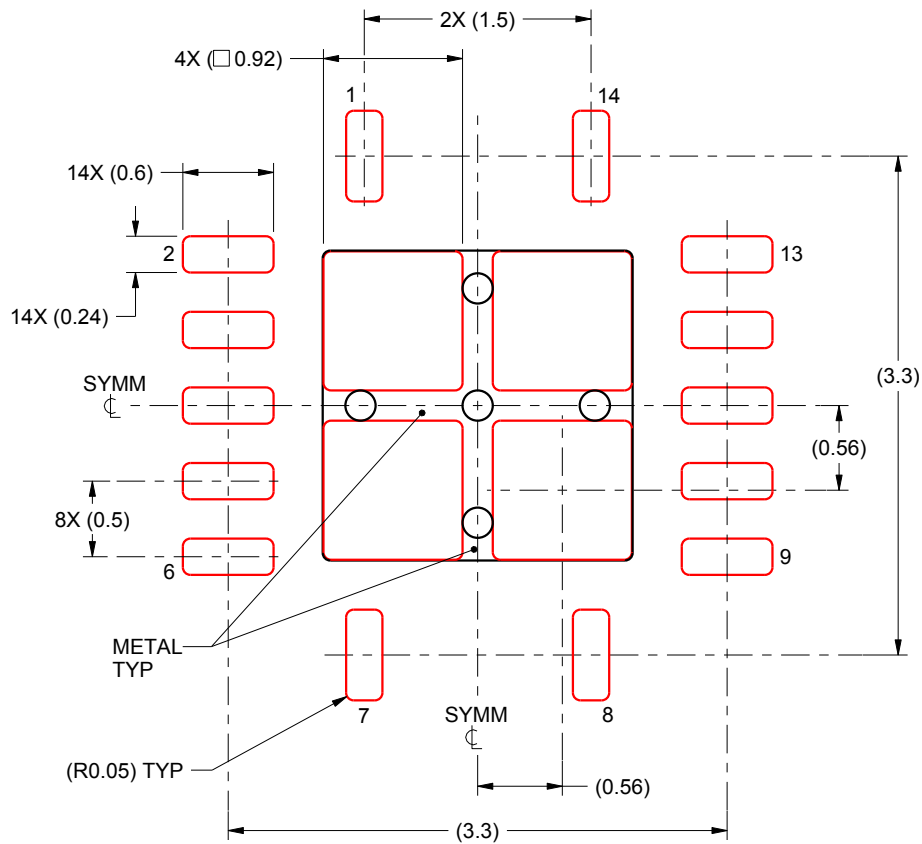

**SOLDER PASTE EXAMPLE**  
BASED ON 0.125 mm THICK STENCIL

EXPOSED PAD  
80% PRINTED SOLDER COVERAGE BY AREA  
SCALE:20X

4219040/A 09/2015

NOTES: (continued)

5. Laser cutting apertures with trapezoidal walls and rounded corners may offer better paste release. IPC-7525 may have alternate design recommendations.



## IMPORTANT NOTICE AND DISCLAIMER

TI PROVIDES TECHNICAL AND RELIABILITY DATA (INCLUDING DATA SHEETS), DESIGN RESOURCES (INCLUDING REFERENCE DESIGNS), APPLICATION OR OTHER DESIGN ADVICE, WEB TOOLS, SAFETY INFORMATION, AND OTHER RESOURCES "AS IS" AND WITH ALL FAULTS, AND DISCLAIMS ALL WARRANTIES, EXPRESS AND IMPLIED, INCLUDING WITHOUT LIMITATION ANY IMPLIED WARRANTIES OF MERCHANTABILITY, FITNESS FOR A PARTICULAR PURPOSE OR NON-INFRINGEMENT OF THIRD PARTY INTELLECTUAL PROPERTY RIGHTS.

These resources are intended for skilled developers designing with TI products. You are solely responsible for (1) selecting the appropriate TI products for your application, (2) designing, validating and testing your application, and (3) ensuring your application meets applicable standards, and any other safety, security, regulatory or other requirements.

These resources are subject to change without notice. TI grants you permission to use these resources only for development of an application that uses the TI products described in the resource. Other reproduction and display of these resources is prohibited. No license is granted to any other TI intellectual property right or to any third party intellectual property right. TI disclaims responsibility for, and you will fully indemnify TI and its representatives against, any claims, damages, costs, losses, and liabilities arising out of your use of these resources.

TI's products are provided subject to [TI's Terms of Sale](#) or other applicable terms available either on [ti.com](https://www.ti.com) or provided in conjunction with such TI products. TI's provision of these resources does not expand or otherwise alter TI's applicable warranties or warranty disclaimers for TI products.

TI objects to and rejects any additional or different terms you may have proposed.

Mailing Address: Texas Instruments, Post Office Box 655303, Dallas, Texas 75265  
Copyright © 2025, Texas Instruments Incorporated