

PCM5140-Q1 クワッド チャネル、768kHz、Burr-Brown™ オーディオ ADC

1 特長

- マルチチャネルの高性能 ADC:
 - 4 チャネルのアナログ マイクロフォンまたはラインイン
 - 8 チャネルのデジタル PDM マイクロフォン
 - アナログとデジタルのマイクロフォンの組み合わせ
- ADC ラインおよびマイクロフォンの差動入力性能:
 - ダイナミックレンジ (DR)
 - ダイナミックレンジ エンハンサ (DRE) が有効な状態で 120dB
 - DRE が無効な状態で 108dB
 - THD+N: -98 dB
- ADC チャネル合計モード、DR 性能:
 - DRE 無効、2 チャネル合計で 111dB
 - DRE 無効、4 チャネル合計で 114dB
- ADC 入力電圧:
 - 差動、 $2V_{RMS}$ フルスケール入力
 - シングルエンド、 $1V_{RMS}$ フルスケール入力
- ADC サンプル・レート (f_s): 8kHz~768kHz
- プログラム可能なチャネル設定:
 - チャンネル ゲイン: 1dB 刻みで 0dB~42dB
 - デジタル ボリューム制御: -100dB~27dB
 - 0.1dB 分解能のゲイン較正
 - 163ns 分解能の位相較正
- マイクロフォンのバイアスまたは電源電圧の生成をプログラム可能
- 低遅延信号処理フィルタの選択
- HPF およびバイカッド デジタル フィルタをプログラム可能
- 自動ゲイン コントローラ (AGC)
- I²C または SPI 制御
- 高性能オーディオ PLL を内蔵
- クロック分周器の設定を自動的に構成
- オーディオ シリアル データ インターフェイス
 - フォーマット: TDM、I²S、左揃え (LJ)
 - ワード長: 16 ビット、20 ビット、24 ビット、32 ビット
 - コントローラまたはターゲットのインターフェイス
- 単一電源動作: 3.3V または 1.8V
- I/O 電源動作: 3.3V または 1.8V
- 1.8V AVDD 電源での消費電力:
 - 8.5 mW/チャンネル (サンプル レート: 16kHz)
 - 9.2mW/チャンネル (サンプル レート: 48kHz)

2 アプリケーション

- マイクロフォン アレイシステム
- 音声作動式のデジタル アシスタント

- 遠隔会議システム
- セキュリティおよび監視システム

3 概要

PCM5140-Q1 は、最大 4 つのアナログ チャネル、またはパルス密度変調 (PDM) マイクロフォン入力のために 8 つのデジタル チャネルを同時にサンプリングできる Burr-Brown™ 高性能オーディオ A/D コンバータ (ADC) です。このデバイスは、ラインおよびマイクロフォン入力をサポートし、シングルエンドと差動の両方の入力構成が可能です。このデバイスには、プログラム可能なチャンネル ゲイン、デジタル ボリューム制御、プログラム可能なマイクロフォンバイアス電圧、フェーズ ロック ループ (PLL)、プログラム可能なハイパスフィルタ (HPF)、バイカッドフィルタ、低遅延フィルタ モードが搭載されており、最高 768kHz のサンプル レートに対応できます。また搭載されており、最高 192kHz のサンプル レートに対応できます。このデバイスは時分割多重化 (TDM)、I²S または、左揃え (LJ) オーディオ・フォーマットに対応し、I²C または SPI で制御可能です。これらの高性能な機能を搭載しており、3.3V または 1.8V の単一電源で動作できることから、遠距離マイクロフォン録音アプリケーションの、スペースの制約が厳しいオーディオ・システムに最適です。

PCM5140-Q1 は -40°C~+125°Cで動作が規定されており、24 ピンの WQFN パッケージで供給されます。

製品情報 (1)

| 部品番号 | パッケージ | パッケージサイズ ⁽²⁾ | 本体サイズ (公称) |
|------------|-----------|-------------------------|---------------------------|
| PCM5140-Q1 | WQFN (24) | 4.00mm × 4.00mm | 4.00mm × 4.00mm、0.5mm ピッチ |

- 利用可能なパッケージについては、データシートの末尾にあるパッケージ オプションについての付録を参照してください。
- パッケージ サイズ (長さ × 幅) は公称値で、該当する場合はピンも含まれます。

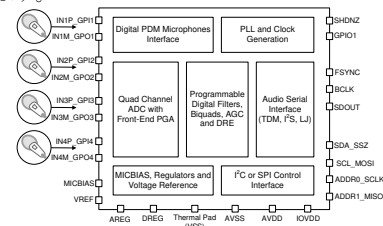

概略ブロック図



Table of Contents

| | | | |
|---|----|--|-----|
| 1 特長 | 1 | 7.1 Overview..... | 20 |
| 2 アプリケーション | 1 | 7.2 Functional Block Diagram..... | 21 |
| 3 概要 | 1 | 7.3 Feature Description..... | 21 |
| 4 Device Comparison Table | 3 | 7.4 Device Functional Modes..... | 60 |
| 5 Pin Configuration and Functions | 4 | 7.5 Programming..... | 61 |
| 6 Specifications | 6 | 7.6 Register Maps..... | 65 |
| 6.1 Absolute Maximum Ratings..... | 6 | 8 Application and Implementation | 113 |
| 6.2 ESD Ratings..... | 6 | 8.1 Application Information..... | 113 |
| 6.3 Recommended Operating Conditions..... | 6 | 8.2 Typical Applications..... | 113 |
| 6.4 Thermal Information..... | 7 | 8.3 What to Do and What Not to Do..... | 120 |
| 6.5 Electrical Characteristics..... | 7 | 9 Power Supply Recommendations | 120 |
| 6.6 Timing Requirements: I ² C Interface..... | 12 | 10 Layout | 121 |
| 6.7 Switching Characteristics: I ² C Interface..... | 13 | 10.1 Layout Guidelines..... | 121 |
| 6.8 Timing Requirements: SPI Interface..... | 13 | 10.2 Layout Example..... | 122 |
| 6.9 Switching Characteristics: SPI Interface..... | 13 | 11 Device and Documentation Support | 123 |
| 6.10 Timing Requirements: TDM, I ² S or LJ Interface..... | 13 | 11.1 Documentation Support..... | 123 |
| 6.11 Switching Characteristics: TDM, I ² S or LJ Interface..... | 13 | 11.2 ドキュメントの更新通知を受け取る方法..... | 123 |
| 6.12 Timing Requirements: PDM Digital Microphone Interface..... | 14 | 11.3 サポート・リソース..... | 123 |
| 6.13 Switching Characteristics: PDM Digital Microphone Interface..... | 14 | 11.4 Trademarks..... | 123 |
| 6.14 Typical Characteristics..... | 16 | 11.5 静電気放電に関する注意事項..... | 123 |
| 7 Detailed Description | 20 | 11.6 用語集..... | 123 |
| | | 12 Revision History | 123 |
| | | 13 Mechanical, Packaging, and Orderable Information | 125 |

4 Device Comparison Table

| FEATURES | TLV320ADC3140 | TLV320ADC5140 | TLV320ADC6140 |
|--------------------------------|---|---------------|---------------|
| Control interface | I ² C or SPI | | |
| Digital audio serial interface | TDM, I ² S, or left-justified (LJ) | | |
| Audio analog channel | 4 | 4 | 4 |
| Digital PDM channel | 8 | 8 | 8 |
| Dynamic range enhancer (DRE) | Not available | Available | Available |
| Dynamic range (DRE disabled) | 106 dB | 108 dB | 113 dB |
| Dynamic range (DRE enabled) | Not available | 120 dB | 123 dB |
| Compatibility | Pin-to-pin, package, and control registers compatible; drop-in replacements of each other | | |
| Package | WQFN (RTW), 24-pin, 4.00 mm × 4.00 mm (0.5-mm pitch) | | |

5 Pin Configuration and Functions



図 5-1. RTW Package 24-Pin WQFN With Exposed Thermal Pad Top View

表 5-1. Pin Functions

| PIN | | TYPE | DESCRIPTION |
|-----|------------|-----------------------------|--|
| NO. | NAME | | |
| 1 | AVDD | Analog supply | Analog power (1.8 V or 3.3 V, nominal) |
| 2 | AREG | Analog supply | Analog on-chip regulator output voltage for analog supply (1.8 V, nominal) or external analog power (1.8 V, nominal) |
| 3 | VREF | Analog | Analog reference voltage filter output |
| 4 | AVSS | Analog supply | Analog ground. Short this pin directly to the board ground plane. |
| 5 | MICBIAS | Analog | MICBIAS output |
| 6 | IN1P_GPI1 | Analog input/digital input | Analog input 1P pin or general-purpose digital input 1 (multipurpose functions such as digital microphone data, PLL input clock source, and so forth) |
| 7 | IN1M_GPO1 | Analog input/digital output | Analog input 1M pin or general-purpose digital output 1 (multipurpose functions such as digital microphone clock, interrupt, and so forth) |
| 8 | IN2P_GPI2 | Analog input/digital input | Analog input 2P pin or general-purpose digital input 2 (multipurpose functions such as digital microphones data, PLL input clock source, and so forth) |
| 9 | IN2M_GPO2 | Analog input/digital output | Analog input 2M pin or general-purpose digital output 2 (multipurpose functions such as digital microphone clock, interrupt, and so forth) |
| 10 | IN3P_GPI3 | Analog input/digital input | Analog input 3P pin or general-purpose digital input 3 (multipurpose functions such as digital microphones data, PLL input clock source, and so forth) |
| 11 | IN3M_GPO3 | Analog input/digital output | Analog input 3M pin or general-purpose digital output 3 (multipurpose functions such as digital microphone clock, interrupt, and so forth) |
| 12 | IN4P_GPI4 | Analog input/digital input | Analog input 4P pin or general-purpose digital input 4 (multipurpose functions such as digital microphones data, PLL input clock source, and so forth) |
| 13 | IN4M_GPO4 | Analog input/digital output | Analog input 4M pin or general-purpose digital output 4 (multipurpose functions such as digital microphone clock, interrupt, and so forth) |
| 14 | SHDNZ | Digital input | Device hardware shutdown and reset (active low) |
| 15 | ADDR1_MISO | Digital I/O | For I ² C operation: I ² C slave address A1 pin For SPI operation: SPI slave output pin |

表 5-1. Pin Functions (続き)

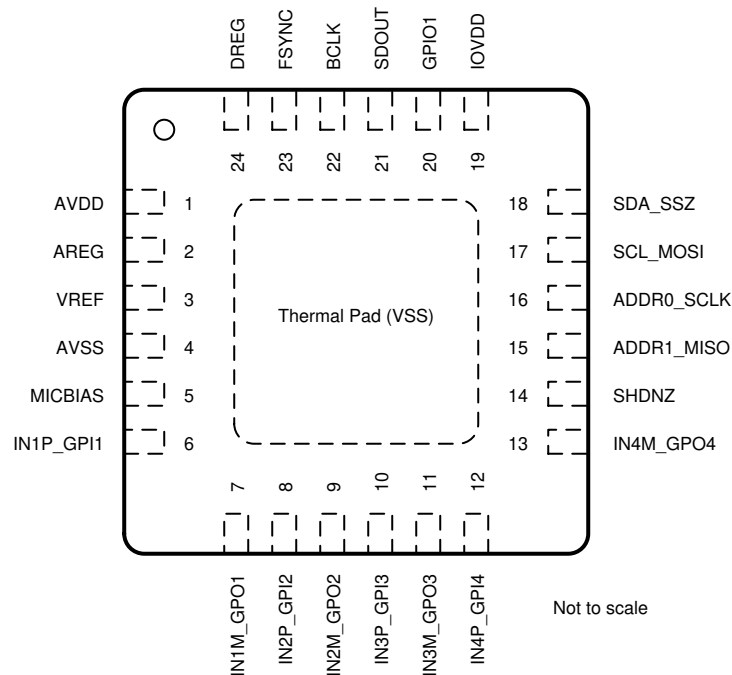
| PIN | | TYPE | DESCRIPTION |
|-------------|-------------------|----------------|--|
| NO. | NAME | | |
| 16 | ADDR0_SCLK | Digital input | For I ² C operation: I ² C slave address A0 pin For SPI operation : SPI serial bit clock |
| 17 | SCL_MOSI | Digital input | For I ² C operation: clock pin for I ² C control bus For SPI operation: SPI slave input pin |
| 18 | SDA_SSZ | Digital I/O | For I ² C operation: data pin for I ² C control bus For SPI operation: SPI slave-select pin |
| 19 | IOVDD | Digital supply | Digital I/O power supply (1.8 V or 3.3 V, nominal) |
| 20 | GPIO1 | Digital I/O | General-purpose digital input/output 1 (multipurpose functions such as digital microphones clock or data, PLL input clock source, interrupt, and so forth) |
| 21 | SDOUT | Digital output | Audio serial data interface bus output |
| 22 | BCLK | Digital I/O | Audio serial data interface bus bit clock |
| 23 | FSYNC | Digital I/O | Audio serial data interface bus frame synchronization signal |
| 24 | DREG | Digital supply | Digital regulator output voltage for digital core supply (1.5 V, nominal) |
| Thermal Pad | Thermal Pad (VSS) | Ground supply | Thermal pad shorted to internal device ground. Short the thermal pad directly to the board ground plane. |

6 Specifications

6.1 Absolute Maximum Ratings

over the operating ambient temperature range (unless otherwise noted)⁽¹⁾

| | | MIN | MAX | UNIT |
|----------------------------|--|------|-------------|------|
| Supply voltage | AVDD to AVSS | -0.3 | 3.9 | V |
| | AREG to AVSS | -0.3 | 2.0 | |
| | IOVDD to VSS (thermal pad) | -0.3 | 3.9 | |
| Ground voltage differences | AVSS to VSS (thermal pad) | -0.3 | 0.3 | V |
| Analog input voltage | Analog input pins voltage to AVSS | -0.3 | AVDD + 0.3 | V |
| Digital input voltage | Digital input except INxP_GPIx pins voltage to VSS (thermal pad) | -0.3 | IOVDD + 0.3 | V |
| | Digital input INxP_GPIx pins voltage to VSS (thermal pad) | -0.3 | AVDD + 0.3 | |
| Temperature | Operating ambient, T _A | -40 | 125 | °C |
| | Junction, T _J | -40 | 150 | |
| | Storage, T _{stg} | -65 | 150 | |

- (1) Stresses beyond those listed under *Absolute Maximum Ratings* may cause permanent damage to the device. These are stress ratings only, which do not imply functional operation of the device at these or any other conditions beyond those indicated under *Recommended Operating Conditions*. Exposure to absolute-maximum-rated conditions for extended periods may affect device reliability.

6.2 ESD Ratings

| | | | VALUE | UNIT |
|--------------------|-------------------------|--|-------|------|
| V _(ESD) | Electrostatic discharge | Human-body model (HBM), per ANSI/ESDA/JEDEC JS-001 ⁽¹⁾ | ±2000 | V |
| | | Charged-device model (CDM), per JEDEC specification JESD22-C101 ⁽²⁾ | ±500 | |

- (1) JEDEC document JEP155 states that 500-V HBM allows safe manufacturing with a standard ESD control process.
 (2) JEDEC document JEP157 states that 250-V CDM allows safe manufacturing with a standard ESD control process.

6.3 Recommended Operating Conditions

| | | MIN | NOM | MAX | UNIT |
|---------------------------|--|------|-----|-----------------------|------|
| POWER | | | | | |
| AVDD, AREG ⁽¹⁾ | Analog supply voltage AVDD to AVSS (AREG is generated using onchip regulator) - AVDD 3.3-V operation | 3.0 | 3.3 | 3.6 | V |
| | Analog supply voltage AVDD and AREG to AVSS (AREG internal regulator is shutdown) - AVDD 1.8-V operation | 1.7 | 1.8 | 1.9 | |
| IOVDD | IO supply voltage to VSS (thermal pad) - IOVDD 3.3-V operation | 3.0 | 3.3 | 3.6 | V |
| | IO supply voltage to VSS (thermal pad) - IOVDD 1.8-V operation | 1.65 | 1.8 | 1.95 | |
| INPUTS | | | | | |
| | Analog input pins voltage to AVSS | 0 | | AVDD | V |
| | Digital input except INxP_GPIx pins voltage to VSS (thermal pad) | 0 | | IOVDD | V |
| | Digital input INxP_GPIx pins voltage to VSS (thermal pad) | 0 | | AVDD | V |
| TEMPERATURE | | | | | |
| T _A | Operating ambient temperature | -40 | | 125 | °C |
| OTHERS | | | | | |
| | GPIOx or GPIx (used as MCLK input) clock frequency | | | 36.864 ⁽²⁾ | MHz |
| C _b | SCL and SDA bus capacitance for I ² C interface supports standard-mode and fast-mode | | | 400 | pF |
| | SCL and SDA bus capacitance for I ² C interface supports fast-mode plus | | | 550 | |
| C _L | Digital output load capacitance | | 20 | 50 | pF |

- (1) AVSS and VSS (thermal pad): all ground pins must be tied together and must not differ in voltage by more than 0.2 V.
 (2) MCLK input rise time (V_{IL} to V_{IH}) and fall time (V_{IH} to V_{IL}) must be less than 5 ns. For better audio noise performance, MCLK input must be used with low jitter.

6.4 Thermal Information

| THERMAL METRIC ⁽¹⁾ | | TLV320ADCx140 | |
|-------------------------------|--|---------------|------|
| | | RTW (WQFN) | |
| | | 24 PINS | |
| | | | UNIT |
| R _{θJA} | Junction-to-ambient thermal resistance | 32.6 | °C/W |
| R _{θJC(top)} | Junction-to-case (top) thermal resistance | 25.0 | °C/W |
| R _{θJB} | Junction-to-board thermal resistance | 11.9 | °C/W |
| Ψ _{JT} | Junction-to-top characterization parameter | 0.2 | °C/W |
| Ψ _{JB} | Junction-to-board characterization parameter | 11.9 | °C/W |
| R _{θJC(bot)} | Junction-to-case (bottom) thermal resistance | 2.9 | °C/W |

(1) For more information about traditional and new thermal metrics, see the [Semiconductor and IC Package Thermal Metrics](#) application report.

6.5 Electrical Characteristics

at T_A = 25°C, AVDD = 3.3 V, IOVDD = 3.3 V, f_{IN} = 1-kHz sinusoidal signal, f_S = 48 kHz, 32-bit audio data, BCLK = 256 × f_S, TDM target mode, PLL on (unless otherwise noted)

| PARAMETER | TEST CONDITIONS | MIN | TYP | MAX | UNIT |
|---|---|--|-----|-----|------------------|
| ADC CONFIGURATION | | | | | |
| AC input impedance | Input pins INxP or INxM, 2.5-kΩ input impedance selection | | 2.5 | | kΩ |
| | Input pins INxP or INxM, 10-kΩ input impedance selection | | 10 | | |
| | Input pins INxP or INxM, 20-kΩ input impedance selection | | 20 | | |
| Channel gain range | Programmable range with 1-dB steps | 0 | | 42 | dB |
| ADC PERFORMANCE FOR LINE/MICROPHONE INPUT RECORDING : AVDD 3.3-V OPERATION | | | | | |
| | Differential input full-scale AC signal voltage | AC-coupled input | | 2 | V _{RMS} |
| | Single-ended input full-scale AC signal voltage | AC-coupled input | | 1 | V _{RMS} |
| SNR | Signal-to-noise ratio, A-weighted ^{(1) (2)} | IN1 differential input selected and AC signal shorted to ground, DRE enabled (DRE_LVL = -36 dB, DRE_MAXGAIN = 24 dB), 2.5-kΩ input impedance selection | 112 | 119 | dB |
| | | IN1 differential input selected and AC signal shorted to ground, DRE enabled (DRE_LVL = -36 dB, DRE_MAXGAIN = 24 dB), 10-kΩ input impedance selection | | 116 | |
| | | IN1 differential input selected and AC signal shorted to ground, DRE disabled, 10-kΩ input impedance selection, 0-dB channel gain | 102 | 107 | |
| | | IN1 differential input selected and AC signal shorted to ground, DRE disabled, 10-kΩ input impedance selection, 12-dB channel gain | | 102 | |
| DR | Dynamic range, A-weighted ⁽²⁾ | IN1 differential input selected and -60-dB full-scale AC signal input, DRE enabled (DRE_LVL = -36 dB, DRE_MAXGAIN = 24 dB), 2.5-kΩ input impedance selection | | 120 | dB |
| | | IN1 differential input selected and -60-dB full-scale AC signal input, DRE enabled (DRE_LVL = -36 dB, DRE_MAXGAIN = 24 dB), 10-kΩ input impedance selection | | 117 | |
| | | IN1 differential input selected and -60-dB full-scale AC signal input, DRE disabled, 10-kΩ input impedance selection, 0-dB channel gain | | 108 | |
| | | IN1 differential input selected and -72-dB full-scale AC signal input, DRE disabled, 10-kΩ input impedance selection, 12-dB channel gain | | 103 | |

at $T_A = 25^\circ\text{C}$, $AVDD = 3.3\text{ V}$, $IOVDD = 3.3\text{ V}$, $f_{IN} = 1\text{-kHz}$ sinusoidal signal, $f_S = 48\text{ kHz}$, 32-bit audio data, $BCLK = 256 \times f_S$, TDM target mode, PLL on (unless otherwise noted)

| PARAMETER | | TEST CONDITIONS | MIN | TYP | MAX | UNIT |
|---|---|--|------|------|-----|-----------|
| THD+N | Total harmonic distortion ⁽²⁾ ⁽³⁾ | IN1 differential input selected and -1-dB full-scale AC signal input, DRE enabled (DRE_LVL = -36 dB, DRE_MAXGAIN = 24 dB), 2.5-k Ω input impedance selection | | -98 | -80 | dB |
| | | IN1 differential input selected and -1-dB full-scale AC signal input, DRE enabled (DRE_LVL = -36 dB, DRE_MAXGAIN = 24 dB), 10-k Ω input impedance selection | | -98 | | |
| | | IN1 differential input selected and -1-dB full-scale AC signal input, DRE disabled, 10-k Ω input impedance selection, 0-dB channel gain | | -98 | | |
| | | IN1 differential input selected and -13-dB full-scale AC signal input, DRE disabled, 10-k Ω input impedance selection, 12-dB channel gain | | -95 | | |
| ADC PERFORMANCE FOR LINE/MICROPHONE INPUT RECORDING : AVDD 1.8-V OPERATION | | | | | | |
| | Differential input full-scale AC signal voltage | AC-coupled Input | | 1 | | V_{RMS} |
| | Single-ended input full-scale AC signal voltage | AC-coupled Input | | 0.5 | | V_{RMS} |
| SNR | Signal-to-noise ratio, A-weighted ⁽¹⁾ ⁽²⁾ | IN1 differential input selected and AC signal shorted to ground, DRE enabled (DRE_LVL = -36 dB, DRE_MAXGAIN = 24 dB), 2.5-k Ω input impedance selection | | 112 | | dB |
| | | IN1 differential input selected and AC signal shorted to ground, DRE enabled (DRE_LVL = -36 dB, DRE_MAXGAIN = 24 dB), 10-k Ω input impedance selection | | 110 | | |
| | | IN1 differential input selected and AC signal shorted to ground, DRE disabled, 10-k Ω input impedance selection, 0-dB channel gain | | 100 | | |
| DR | Dynamic range, A-weighted ⁽²⁾ | IN1 differential input selected and -60-dB full-scale AC signal input, DRE enabled (DRE_LVL = -36 dB, DRE_MAXGAIN = 24 dB), 2.5-k Ω input impedance selection | | 113 | | dB |
| | | IN1 differential input selected and -60-dB full-scale AC signal input, DRE enabled (DRE_LVL = -36 dB, DRE_MAXGAIN = 24 dB), 10-k Ω input impedance selection | | 111 | | |
| | | IN1 differential input selected and -60-dB full-scale AC signal input, DRE disabled, 0-dB channel gain | | 101 | | |
| THD+N | Total harmonic distortion ⁽²⁾ ⁽³⁾ | IN1 differential input selected and -2-dB full-scale AC signal input, DRE enabled (DRE_LVL = -36 dB, DRE_MAXGAIN = 24 dB), 2.5-k Ω input impedance selection | | -90 | | dB |
| | | IN1 differential input selected and -2-dB full-scale AC signal input, DRE enabled (DRE_LVL = -36 dB, DRE_MAXGAIN = 24 dB), 10-k Ω input impedance selection | | -90 | | |
| | | IN1 differential input selected and -2-dB full-scale AC signal input, DRE disabled, 10-k Ω input impedance selection, 0 dB channel gain | | -90 | | |
| ADC OTHER PARAMETERS | | | | | | |
| | Digital volume control range | Programmable 0.5-dB steps | -100 | | 27 | dB |
| | Output data sample rate | Programmable | 7.35 | | 768 | kHz |
| | Output data sample word length | Programmable | 16 | | 32 | Bits |
| | Digital high-pass filter cutoff frequency | First-order IIR filter with programmable coefficients, -3-dB point (default setting) | | 12 | | Hz |
| | Interchannel isolation | -1-dB full-scale AC-signal input to non measurement channel | | -124 | | dB |
| | Interchannel gain mismatch | -6-dB full-scale AC-signal input and 0-dB channel gain | | 0.1 | | dB |

at $T_A = 25^\circ\text{C}$, $AVDD = 3.3\text{ V}$, $IOVDD = 3.3\text{ V}$, $f_{IN} = 1\text{-kHz}$ sinusoidal signal, $f_S = 48\text{ kHz}$, 32-bit audio data, $BCLK = 256 \times f_S$, TDM target mode, PLL on (unless otherwise noted)

| PARAMETER | | TEST CONDITIONS | MIN | TYP | MAX | UNIT |
|------------------------|--|---|----------------------------|---------------------|----------------------------|----------------------------|
| | Gain drift | 0-dB channel gain, across temperature range 15°C to 35°C | | -4.4 | | ppm/ $^\circ\text{C}$ |
| | Interchannel phase mismatch | 1-kHz sinusoidal signal | | 0.02 | | Degrees |
| | Phase drift | 1-kHz sinusoidal signal, across temperature range 15°C to 35°C | | 0.0005 | | Degrees/ $^\circ\text{C}$ |
| PSRR | Power-supply rejection ratio | 100-mV _{PP} , 1-kHz sinusoidal signal on AVDD, differential input selected, 0-dB channel gain | | 102 | | dB |
| CMRR | Common-mode rejection ratio | Differential microphone input selected, 0-dB channel gain, 100-mV _{PP} , 1-kHz signal on both pins and measure level at output | | 60 | | dB |
| MICROPHONE BIAS | | | | | | |
| | MICBIAS noise | BW = 20 Hz to 20 kHz, A-weighted, 1- μF capacitor between MICBIAS and AVSS | | 1.6 | | μV_{RMS} |
| | MICBIAS voltage | MICBIAS programmed to VREF and VREF programmed to either 2.75 V, 2.5 V, or 1.375 V | | VREF | | V |
| | | MICBIAS programmed to VREF \times 1.096 and VREF programmed to either 2.75 V, 2.5 V, or 1.375 V | | VREF \times 1.096 | | |
| | | Bypass to AVDD with 20-mA load | | AVDD - 0.2 | | |
| | MICBIAS current drive | MICBIAS voltage $\geq 2.5\text{ V}$ | | | 20 | mA |
| | | MICBIAS voltage $< 2.5\text{ V}$ | | | 10 | |
| | MICBIAS load regulation | MICBIAS programmed to either VREF or VREF \times 1.096, measured up to max load | 0 | 0.6 | 1.8 | % |
| | MICBIAS over current protection threshold | | 30 | | | mA |
| DIGITAL I/O | | | | | | |
| $V_{IL(\text{SHDNZ})}$ | Low-level digital input logic voltage threshold | SHDNZ pin | -0.3 | | $0.25 \times \text{IOVDD}$ | V |
| $V_{IH(\text{SHDNZ})}$ | High-level digital input logic voltage threshold | SHDNZ pin | $0.75 \times \text{IOVDD}$ | | $\text{IOVDD} + 0.3$ | V |
| V_{IL} | Low-level digital input logic voltage threshold | All digital pins except INxP_GPIx, SDA and SCL, IOVDD 1.8-V operation | -0.3 | | $0.35 \times \text{IOVDD}$ | V |
| | | All digital pins except INxP_GPIx, SDA and SCL, IOVDD 3.3-V operation | -0.3 | | 0.8 | |
| V_{IH} | High-level digital input logic voltage threshold | All digital pins except INxP_GPIx, SDA and SCL, IOVDD 1.8-V operation | $0.65 \times \text{IOVDD}$ | | $\text{IOVDD} + 0.3$ | V |
| | | All digital pins except INxP_GPIx, SDA and SCL, IOVDD 3.3-V operation | 2 | | $\text{IOVDD} + 0.3$ | |
| V_{OL} | Low-level digital output voltage | All digital pins except INxM_GPOx, SDA and SCL, $I_{OL} = -2\text{ mA}$, IOVDD 1.8-V operation | | | 0.45 | V |
| | | All digital pins except INxM_GPOx, SDA and SCL, $I_{OL} = -2\text{ mA}$, IOVDD 3.3-V operation | | | 0.4 | |
| V_{OH} | High-level digital output voltage | All digital pins except INxM_GPOx, SDA and SCL, $I_{OH} = 2\text{ mA}$, IOVDD 1.8-V operation | $\text{IOVDD} - 0.45$ | | | V |
| | | All digital pins except INxM_GPOx, SDA and SCL, $I_{OH} = 2\text{ mA}$, IOVDD 3.3-V operation | 2.4 | | | |
| $V_{IL(12C)}$ | Low-level digital input logic voltage threshold | SDA and SCL | -0.5 | | $0.3 \times \text{IOVDD}$ | V |
| $V_{IH(12C)}$ | High-level digital input logic voltage threshold | SDA and SCL | $0.7 \times \text{IOVDD}$ | | $\text{IOVDD} + 0.5$ | V |
| $V_{OL1(12C)}$ | Low-level digital output voltage | SDA, $I_{OL(12C)} = -3\text{ mA}$, $\text{IOVDD} > 2\text{ V}$ | | | 0.4 | V |
| $V_{OL2(12C)}$ | Low-level digital output voltage | SDA, $I_{OL(12C)} = -2\text{ mA}$, $\text{IOVDD} \leq 2\text{ V}$ | | | $0.2 \times \text{IOVDD}$ | V |
| $I_{OL(12C)}$ | Low-level digital output current | SDA, $V_{OL(12C)} = 0.4\text{ V}$, standard-mode or fast-mode | 3 | | | mA |
| | | SDA, $V_{OL(12C)} = 0.4\text{ V}$, fast-mode plus | 20 | | | |

at $T_A = 25^\circ\text{C}$, $AVDD = 3.3\text{ V}$, $IOVDD = 3.3\text{ V}$, $f_{IN} = 1\text{-kHz}$ sinusoidal signal, $f_S = 48\text{ kHz}$, 32-bit audio data, $BCLK = 256 \times f_S$, TDM target mode, PLL on (unless otherwise noted)

| PARAMETER | | TEST CONDITIONS | MIN | TYP | MAX | UNIT |
|---|--|--|--------------------|--------------------|--------------|---------------|
| I_{IH} | Input logic-high leakage for digital inputs | All digital pins except INxP_GPIx pins, input = IOVDD | -5 | 0.1 | 5 | μA |
| I_{IL} | Input logic-low leakage for digital inputs | All digital pins except INxP_GPIx pins, input = 0 V | -5 | 0.1 | 5 | μA |
| $V_{IL(\text{GPIx})}$ | Low-level digital input logic voltage threshold | All INxP_GPIx digital pins, AVDD 1.8-V operation | -0.3 | $0.35 \times AVDD$ | | V |
| | | All INxP_GPIx digital pins, AVDD 3.3-V operation | -0.3 | | 0.8 | |
| $V_{IH(\text{GPIx})}$ | High-level digital input logic voltage threshold | All INxP_GPIx digital pins, AVDD 1.8-V operation | $0.65 \times AVDD$ | | $AVDD + 0.3$ | V |
| | | All INxP_GPIx digital pins, AVDD 3.3-V operation | 2 | | $AVDD + 0.3$ | |
| $V_{OL(\text{GPOx})}$ | Low-level digital output voltage | All INxM_GPOx digital pins, $I_{OL} = -2\text{ mA}$, AVDD 1.8-V operation | | | 0.45 | V |
| | | All INxM_GPOx digital pins, $I_{OL} = -2\text{ mA}$, AVDD 3.3-V operation | | | 0.4 | |
| $V_{OH(\text{GPOx})}$ | High-level digital output voltage | All INxM_GPOx digital pins, $I_{OH} = 2\text{ mA}$, AVDD 1.8-V operation | $AVDD - 0.45$ | | | V |
| | | All INxM_GPOx digital pins, $I_{OH} = 2\text{ mA}$, AVDD 3.3-V operation | 2.4 | | | |
| $I_{IH(\text{GPIx})}$ | Input logic-high leakage for digital inputs | All INxP_GPIx digital pins, input = AVDD | -5 | 0.1 | 5 | μA |
| $I_{IL(\text{GPIx})}$ | Input logic-low leakage for digital inputs | All INxP_GPIx digital pins, input = 0 V | -5 | 0.1 | 5 | μA |
| C_{IN} | Input capacitance for digital inputs | All digital pins | | 5 | | pF |
| R_{PD} | Pulldown resistance for digital I/O pins when asserted on | | | 20 | | k Ω |
| TYPICAL SUPPLY CURRENT CONSUMPTION | | | | | | |
| I_{AVDD} | Current consumption in hardware shutdown mode | SHDNZ = 0, AVDD = 3.3 V, internal AREG | | 0.5 | | μA |
| I_{AVDD} | | SHDNZ = 0, AVDD = 1.8 V, external AREG supply (AREG shorted to AVDD) | | 0.5 | | |
| I_{IOVDD} | | SHDNZ = 0, all external clocks stopped, IOVDD = 3.3 V | | 0.1 | | |
| I_{IOVDD} | | SHDNZ = 0, all external clocks stopped, IOVDD = 1.8 V | | 0.1 | | |
| I_{AVDD} | Current consumption in sleep mode (software shutdown mode) | All external clocks stopped, AVDD = 3.3 V, internal AREG | | 5 | | μA |
| I_{AVDD} | | All external clocks stopped, AVDD = 1.8 V, external AREG supply (AREG shorted to AVDD) | | 5 | | |
| I_{IOVDD} | | All external clocks stopped, IOVDD = 3.3 V | | 0.1 | | |
| I_{IOVDD} | | All external clocks stopped, IOVDD = 1.8 V | | 0.1 | | |
| I_{AVDD} | Current consumption with ADC 2-channel operating at $f_S = 48\text{-kHz}$, PLL off, BCLK = $512 \times f_S$ and DRE disable | AVDD = 3.3 V, internal AREG | | 11.3 | | mA |
| I_{AVDD} | | AVDD = 1.8 V, external AREG supply (AREG shorted to AVDD) | | 10.7 | | |
| I_{IOVDD} | | IOVDD = 3.3 V | | 0.1 | | |
| I_{IOVDD} | | IOVDD = 1.8 V | | 0.05 | | |
| I_{AVDD} | Current consumption with ADC 4-channel operating at $f_S = 16\text{-kHz}$, PLL on, BCLK = $256 \times f_S$ and DRE disable | AVDD = 3.3 V, internal AREG | | 19.7 | | mA |
| I_{AVDD} | | AVDD = 1.8 V, external AREG supply (AREG shorted to AVDD) | | 18.6 | | |
| I_{IOVDD} | | IOVDD = 3.3 V | | 0.05 | | |
| I_{IOVDD} | | IOVDD = 1.8 V | | 0.02 | | |
| I_{AVDD} | Current consumption with ADC 4-channel operating at $f_S = 48\text{-kHz}$, PLL on, BCLK = $256 \times f_S$ and DRE disable | AVDD = 3.3 V, internal AREG | | 21.3 | | mA |
| I_{AVDD} | | AVDD = 1.8 V, external AREG supply (AREG shorted to AVDD) | | 20.2 | | |
| I_{IOVDD} | | IOVDD = 3.3 V | | 0.1 | | |
| I_{IOVDD} | | IOVDD = 1.8 V | | 0.05 | | |

at $T_A = 25^\circ\text{C}$, $AVDD = 3.3\text{ V}$, $IOVDD = 3.3\text{ V}$, $f_{IN} = 1\text{-kHz}$ sinusoidal signal, $f_S = 48\text{ kHz}$, 32-bit audio data, $BCLK = 256 \times f_S$, TDM target mode, PLL on (unless otherwise noted)

| PARAMETER | | TEST CONDITIONS | MIN | TYP | MAX | UNIT |
|-------------|--|--|-----|------|-----|------|
| I_{AVDD} | Current consumption with ADC 4-channel operating at f_S 48-kHz, PLL on, BCLK = $256 \times f_S$ and DRE enable | $AVDD = 3.3\text{ V}$, internal AREG | | 23.6 | | mA |
| I_{AVDD} | | $AVDD = 1.8\text{ V}$, external AREG supply (AREG shorted to $AVDD$) | | 22.3 | | |
| I_{IOVDD} | | $IOVDD = 3.3\text{ V}$ | | 0.1 | | |
| I_{IOVDD} | | $IOVDD = 1.8\text{ V}$ | | 0.05 | | |

- (1) Ratio of output level with 1-kHz full-scale sine-wave input, to the output level with the AC signal input shorted to ground, measured A-weighted over a 20-Hz to 20-kHz bandwidth using an audio analyzer.
- (2) All performance measurements done with 20-kHz low-pass filter and, where noted, A-weighted filter. Failure to use such a filter may result in higher THD and lower SNR and dynamic range readings than shown in the Electrical Characteristics. The low-pass filter removes out-of-band noise, which, although not audible, may affect dynamic specification values.
- (3) For best distortion performance, use input AC-coupling capacitors with low-voltage-coefficient.

6.6 Timing Requirements: I²C Interface

at T_A = 25°C, IOVDD = 3.3 V or 1.8 V (unless otherwise noted); see [Figure 1](#) for timing diagram

| | | MIN | NOM | MAX | UNIT |
|-----------------------|--|------|----------------------------|------|------|
| STANDARD-MODE | | | | | |
| f _{SCL} | SCL clock frequency | 0 | | 100 | kHz |
| t _{HD,STA} | Hold time (repeated) START condition. After this period, the first clock pulse is generated. | 4 | | | μs |
| t _{LOW} | Low period of the SCL clock | 4.7 | | | μs |
| t _{HIGH} | High period of the SCL clock | 4 | | | μs |
| t _{SU,STA} | Setup time for a repeated START condition | 4.7 | | | μs |
| t _{HD,DAT} | Data hold time | 0 | | 3.45 | μs |
| t _{SU,DAT} | Data setup time | 250 | | | ns |
| t _r | SDA and SCL rise time | | | 1000 | ns |
| t _f | SDA and SCL fall time | | | 300 | ns |
| t _{SU,STO} | Setup time for STOP condition | 4 | | | μs |
| t _{BUF} | Bus free time between a STOP and START condition | 4.7 | | | μs |
| FAST-MODE | | | | | |
| f _{SCL} | SCL clock frequency | 0 | | 400 | kHz |
| t _{HD,STA} | Hold time (repeated) START condition. After this period, the first clock pulse is generated. | 0.6 | | | μs |
| t _{LOW} | Low period of the SCL clock | 1.3 | | | μs |
| t _{HIGH} | High period of the SCL clock | 0.6 | | | μs |
| t _{SU,STA} | Setup time for a repeated START condition | 0.6 | | | μs |
| t _{HD,DAT} | Data hold time | 0 | | 0.9 | μs |
| t _{SU,DAT} | Data setup time | 100 | | | ns |
| t _r | SDA and SCL rise time | 20 | | 300 | ns |
| t _f | SDA and SCL fall time | | 20 × (IOVDD / 5.5 V) | 300 | ns |
| t _{SU,STO} | Setup time for STOP condition | 0.6 | | | μs |
| t _{BUF} | Bus free time between a STOP and START condition | 1.3 | | | μs |
| FAST-MODE PLUS | | | | | |
| f _{SCL} | SCL clock frequency | 0 | | 1000 | kHz |
| t _{HD,STA} | Hold time (repeated) START condition. After this period, the first clock pulse is generated. | 0.26 | | | μs |
| t _{LOW} | Low period of the SCL clock | 0.5 | | | μs |
| t _{HIGH} | High period of the SCL clock | 0.26 | | | μs |
| t _{SU,STA} | Setup time for a repeated START condition | 0.26 | | | μs |
| t _{HD,DAT} | Data hold time | 0 | | | μs |
| t _{SU,DAT} | Data setup time | 50 | | | ns |
| t _r | SDA and SCL rise time | | | 120 | ns |
| t _f | SDA and SCL fall time | | 20 × (IOVDD / 5.5 V) | 120 | ns |
| t _{SU,STO} | Setup time for STOP condition | 0.26 | | | μs |
| t _{BUF} | Bus free time between a STOP and START condition | 0.5 | | | μs |

6.7 Switching Characteristics: I²C Interface

at T_A = 25°C, IOVDD = 3.3 V or 1.8 V (unless otherwise noted); see Figure 1 for timing diagram

| PARAMETER | | TEST CONDITIONS | MIN | TYP | MAX | UNIT |
|----------------------|------------------|-----------------|-----|-----|------|------|
| t _d (SDA) | SCL to SDA delay | Standard-mode | 250 | | 1250 | ns |
| | | Fast-mode | 250 | | 850 | |
| | | Fast-mode plus | | | 400 | |

6.8 Timing Requirements: SPI Interface

at T_A = 25°C, IOVDD = 3.3 V or 1.8 V and 20-pF load on all outputs (unless otherwise noted); see Figure 2 for timing diagram

| | | MIN | NOM | MAX | UNIT |
|-------------------------|---------------------------|---------------------|-----|-----|------|
| t _(SCLK) | SCLK period | 40 | | | ns |
| t _H (SCLK) | SCLK high pulse duration | 18 | | | ns |
| t _L (SCLK) | SCLK low pulse duration | 18 | | | ns |
| t _{LEAD} | Enable lead time | 16 | | | ns |
| t _{TRAIL} | Enable trail time | 16 | | | ns |
| t _{DSEQ} | Sequential transfer delay | 20 | | | ns |
| t _{SU} (MOSI) | MOSI data setup time | 8 | | | ns |
| t _{HLD} (MOSI) | MOSI data hold time | 8 | | | ns |
| t _r (SCLK) | SCLK rise time | 10% - 90% rise time | | 6 | ns |
| t _f (SCLK) | SCLK fall time | 90% - 10% fall time | | 6 | ns |

6.9 Switching Characteristics: SPI Interface

at T_A = 25°C, IOVDD = 3.3 V or 1.8 V and 20-pF load on all outputs (unless otherwise noted); see Figure 2 for timing diagram

| PARAMETER | | TEST CONDITIONS | MIN | TYP | MAX | UNIT |
|-------------------------|--------------------|----------------------------|-----|-----|-----|------|
| t _a (MISO) | MISO access time | | | | 16 | ns |
| t _d (MISO) | SCLK to MISO delay | 50% of SCLK to 50% of MISO | | | 16 | ns |
| t _{dis} (MISO) | MISO disable time | | | | 20 | ns |

6.10 Timing Requirements: TDM, I²S or LJ Interface

at T_A = 25°C, IOVDD = 3.3 V or 1.8 V and 20-pF load on all outputs (unless otherwise noted); see Figure 3 for timing diagram

| | | MIN | NOM | MAX | UNIT |
|--------------------------|---|---------------------|-----|-----|------|
| t _(BCLK) | BCLK period | 40 | | | ns |
| t _H (BCLK) | BCLK high pulse duration ⁽¹⁾ | 18 | | | ns |
| t _L (BCLK) | BCLK low pulse duration ⁽¹⁾ | 18 | | | ns |
| t _{SU} (FSYNC) | FSYNC setup time | 8 | | | ns |
| t _{HLD} (FSYNC) | FSYNC hold time | 8 | | | ns |
| t _r (BCLK) | BCLK rise time | 10% - 90% rise time | | 10 | ns |
| t _f (BCLK) | BCLK fall time | 90% - 10% fall time | | 10 | ns |

(1) The BCLK minimum high or low pulse duration must be higher than 25 ns (to meet the timing specifications), if the SDO_{UT} data line is latched on the opposite BCLK edge polarity than the edge used by the device to transmit SDO_{UT} data.

6.11 Switching Characteristics: TDM, I²S or LJ Interface

at T_A = 25°C, IOVDD = 3.3 V or 1.8 V and 20-pF load on all outputs (unless otherwise noted); see Figure 3 for timing diagram

| PARAMETER | | TEST CONDITIONS | MIN | TYP | MAX | UNIT |
|------------------------------|--|--|-----|-----|-----|------|
| t _d (SDOUT-BCLK) | BCLK to SDO _{UT} delay | 50% of BCLK to 50% of SDO _{UT} | | | 18 | ns |
| t _d (SDOUT-FSYNC) | FSYNC to SDO _{UT} delay in TDM or LJ mode (for MSB data with TX_OFFSET = 0) | 50% of FSYNC to 50% of SDO _{UT} | | | 18 | ns |

at $T_A = 25^\circ\text{C}$, IOVDD = 3.3 V or 1.8 V and 20-pF load on all outputs (unless otherwise noted); see Figure 3 for timing diagram

| PARAMETER | TEST CONDITIONS | MIN | TYP | MAX | UNIT |
|------------------------------|--|-----------------------------|-----|--------|------|
| $f_{(\text{BCLK})}$ | BCLK output clock frequency: controller mode (1) | | | 24.576 | MHz |
| $t_{\text{H}(\text{BCLK})}$ | BCLK high pulse duration: controller mode | 14 | | | ns |
| $t_{\text{L}(\text{BCLK})}$ | BCLK low pulse duration: controller mode | 14 | | | ns |
| $t_{\text{d}(\text{FSYNC})}$ | BCLK to FSYNC delay: controller mode | 50% of BCLK to 50% of FSYNC | | 18 | ns |
| $t_{\text{r}(\text{BCLK})}$ | BCLK rise time: controller mode | 10% - 90% rise time | | 8 | ns |
| $t_{\text{f}(\text{BCLK})}$ | BCLK fall time: controller mode | 90% - 10% fall time | | 8 | ns |

(1) The BCLK output clock frequency must be lower than 18.5 MHz (to meet the timing specifications), if the SDOOUT data line is latched on the opposite BCLK edge polarity than the edge used by the device to transmit SDOOUT data.

6.12 Timing Requirements: PDM Digital Microphone Interface

at $T_A = 25^\circ\text{C}$, IOVDD = 3.3 V or 1.8 V and 20-pF load on all outputs (unless otherwise noted); see Figure 4 for timing diagram

| PARAMETER | TEST CONDITIONS | MIN | NOM | MAX | UNIT |
|---|----------------------|-----|-----|-----|------|
| $t_{\text{SU}(\text{PDM}(\text{DIN}x))}$ | PDM(DINx) setup time | 30 | | | ns |
| $t_{\text{HLD}(\text{PDM}(\text{DIN}x))}$ | PDM(DINx) hold time | 0 | | | ns |

6.13 Switching Characteristics: PDM Digital Microphone Interface

at $T_A = 25^\circ\text{C}$, IOVDD = 3.3 V or 1.8 V and 20-pF load on all outputs (unless otherwise noted); see Figure 4 for timing diagram

| PARAMETER | TEST CONDITIONS | MIN | TYP | MAX | UNIT |
|--|----------------------------|---------------------|-----|-------|------|
| $f_{(\text{PDM}(\text{CLK}))}$ | PDMCLK clock frequency | 0.768 | | 6.144 | MHz |
| $t_{\text{H}(\text{PDM}(\text{CLK}))}$ | PDMCLK high pulse duration | 72 | | | ns |
| $t_{\text{L}(\text{PDM}(\text{CLK}))}$ | PDMCLK low pulse duration | 72 | | | ns |
| $t_{\text{r}(\text{PDM}(\text{CLK}))}$ | PDMCLK rise time | 10% - 90% rise time | | 18 | ns |
| $t_{\text{f}(\text{PDM}(\text{CLK}))}$ | PDMCLK fall time | 90% - 10% fall time | | 18 | ns |



图 6-1. I²C Interface Timing Diagram



図 6-2. SPI Interface Timing Diagram

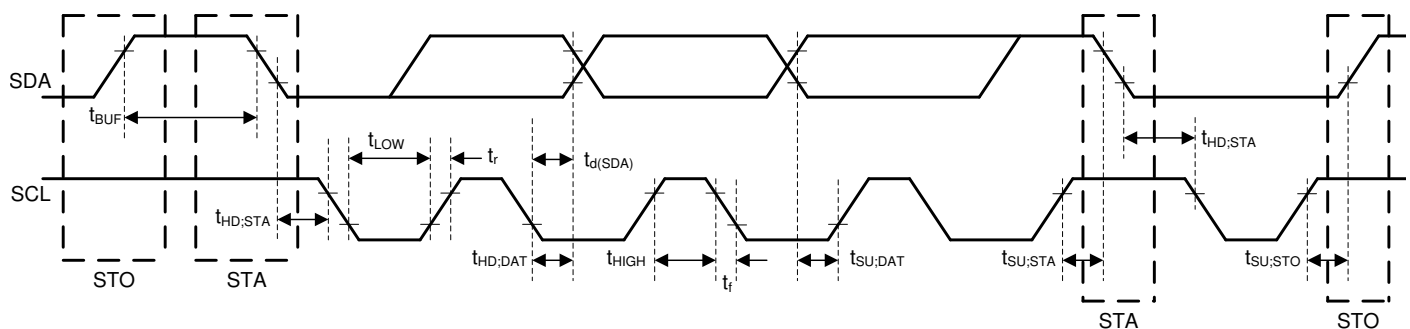

図 6-3. TDM (With BCLK_POL = 1), I²S, and LJ Interface Timing Diagram

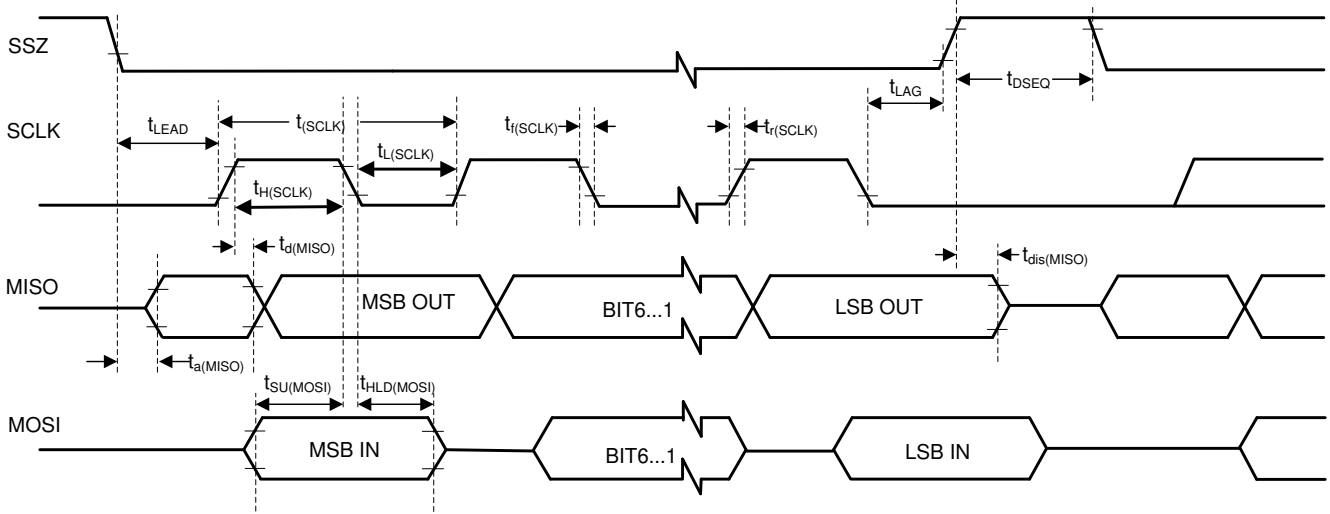

図 6-4. PDM Digital Microphone Interface Timing Diagram

6.14 Typical Characteristics

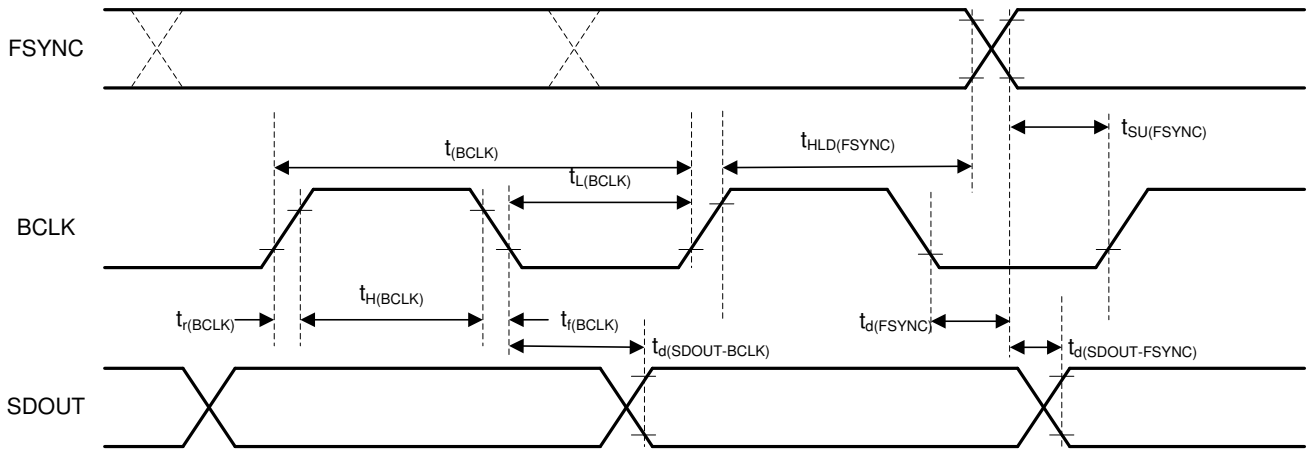
at $T_A = 25^\circ\text{C}$, $AV_{DD} = 3.3\text{ V}$, $IOV_{DD} = 3.3\text{ V}$, $f_{IN} = 1\text{-kHz}$ sinusoidal signal, $f_S = 48\text{ kHz}$, 32-bit audio data, $BCLK = 256 \times f_S$, TDM target mode, PLL on, $DRE_LVL = -36\text{ dB}$, channel gain = 0 dB, and linear phase decimation filter (unless otherwise noted); all performance measurements are done with a 20-kHz, low-pass filter, and an A-weighted filter

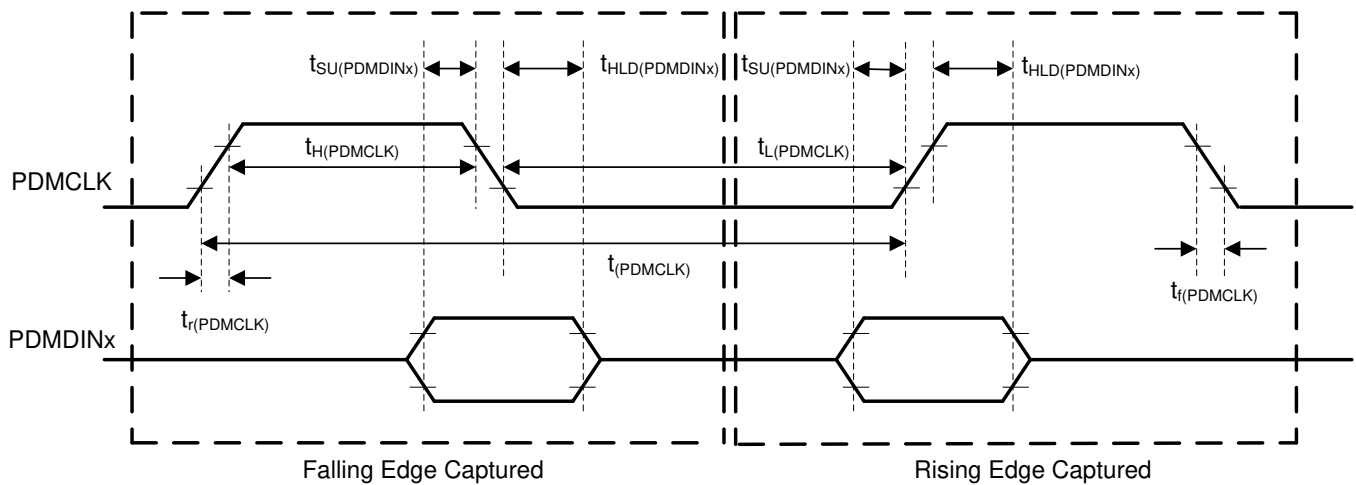
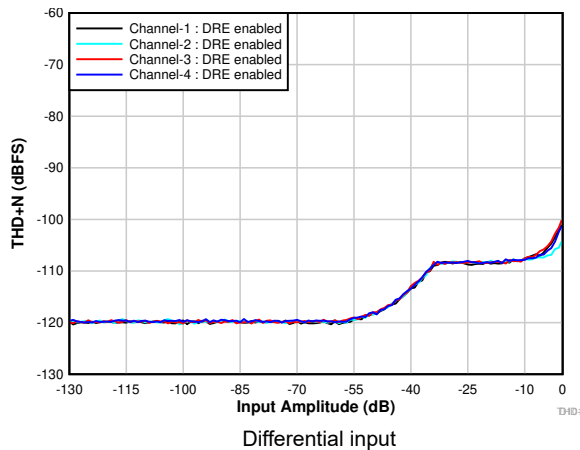

6-5. THD+N vs Input Amplitude With DRE Enabled

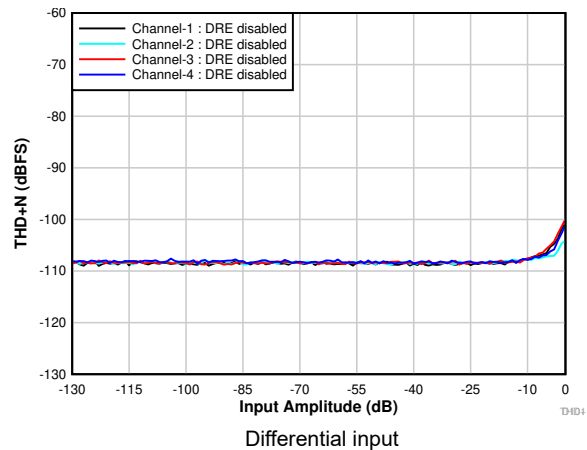

6-6. THD+N vs Input Amplitude With DRE Disabled

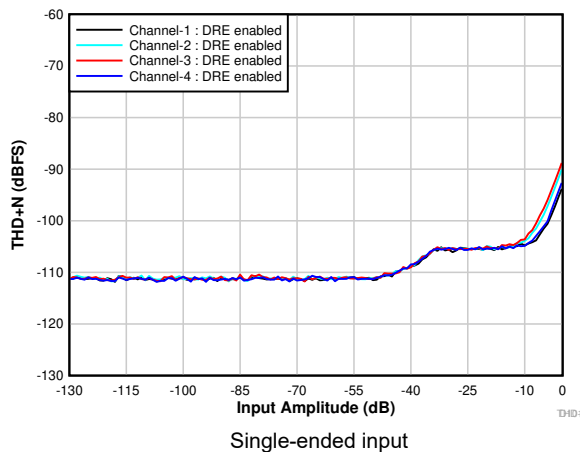

6-7. THD+N vs Input Amplitude With DRE Enabled

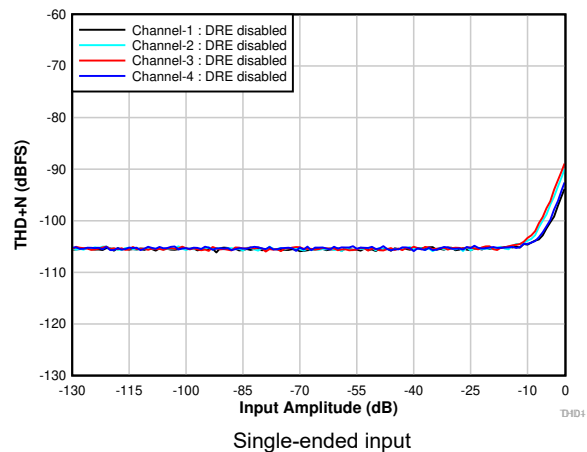

6-8. THD+N vs Input Amplitude With DRE Disabled

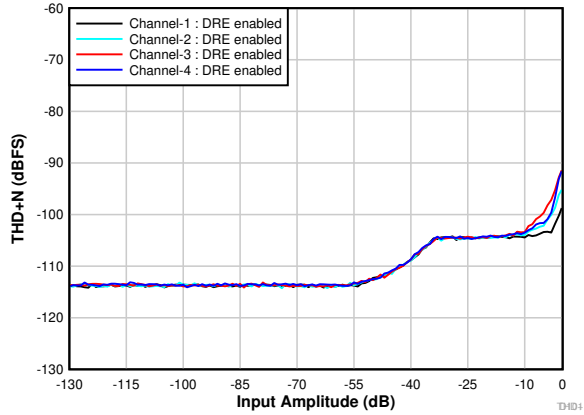

Differential input with AVDD = 1.8 V and VREF = 1.375 V

6-9. THD+N vs Input Amplitude With DRE Enabled

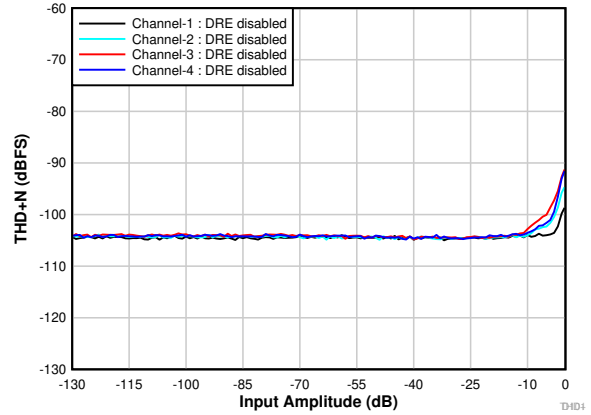

Differential input with AVDD = 1.8 V and VREF = 1.375 V

6-10. THD+N vs Input Amplitude With DRE Disabled

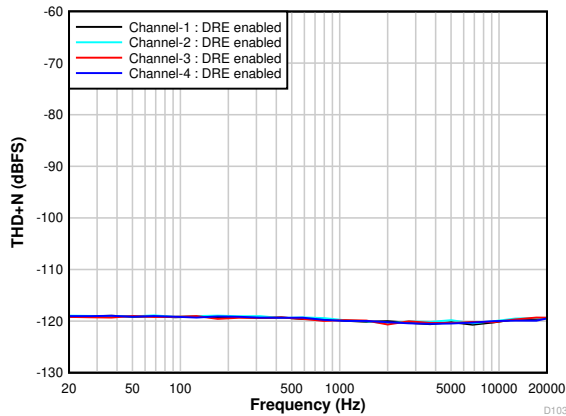

6-11. THD+N vs Input Frequency With a -60-dB Input

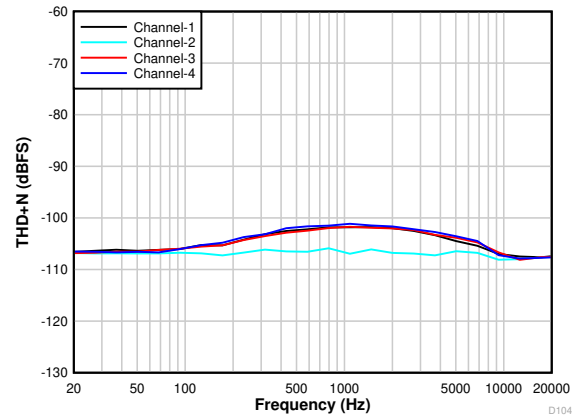

6-12. THD+N vs Input Frequency With a -1-dB Input

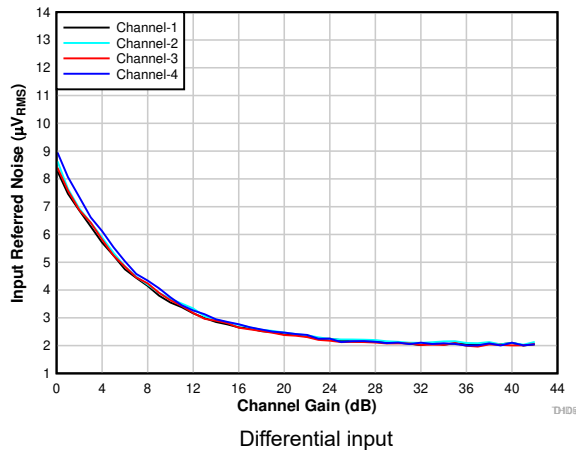

6-13. Input-Referred Noise vs Channel Gain

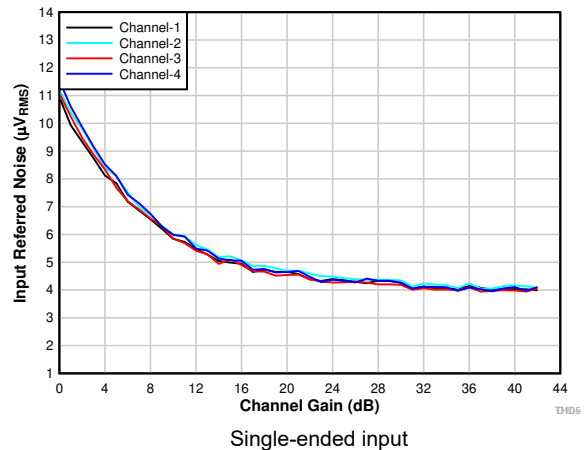

6-14. Input-Referred Noise vs Channel Gain

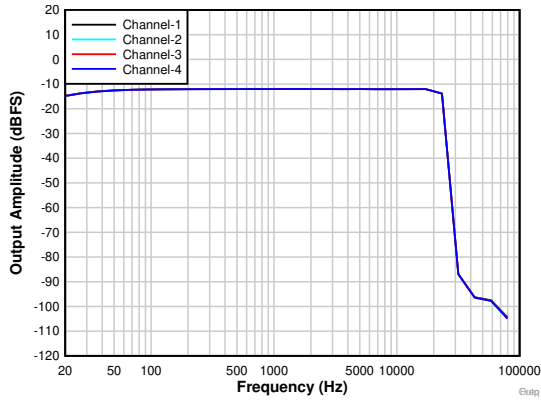

6-15. Frequency Response With a -12-dBr Input

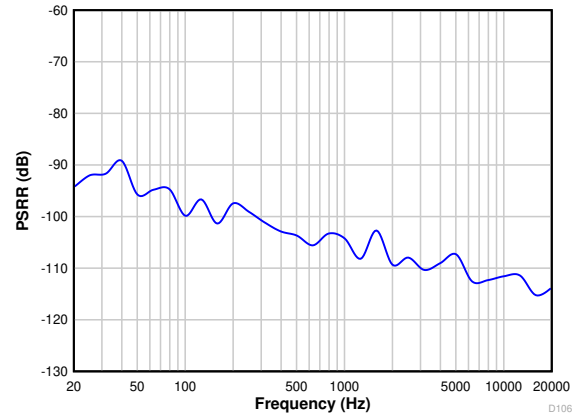

6-16. Power-Supply Rejection Ratio vs Ripple Frequency With 100-mV_{pp} Amplitude

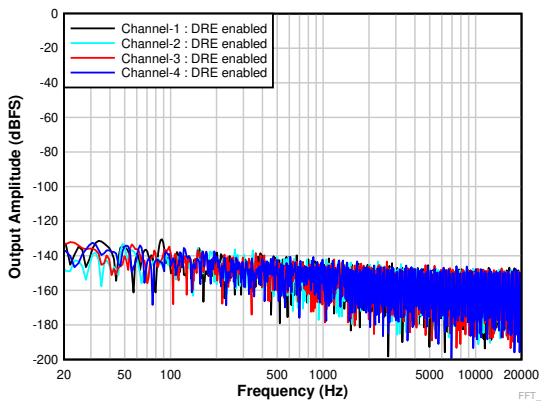

6-17. FFT With Idle Input With DRE Enabled

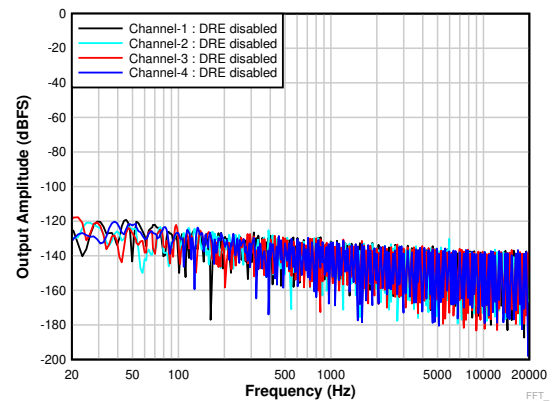

6-18. FFT With Idle Input With DRE Disabled

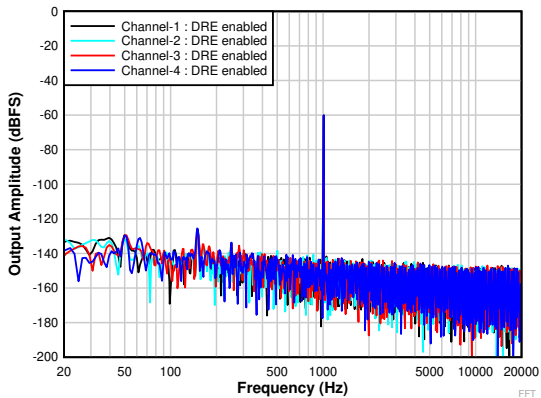

6-19. FFT With a -60-dBr Input With DRE Enabled

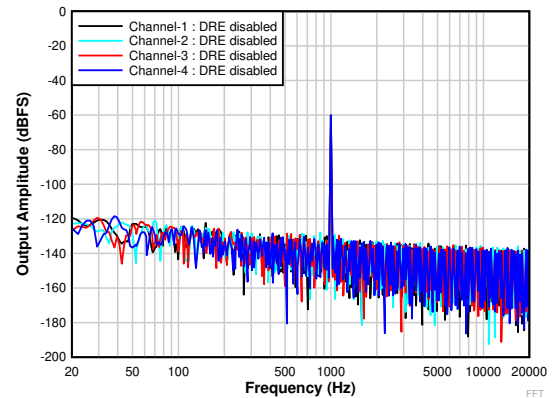

6-20. FFT With a -60-dBr Input With DRE Disabled

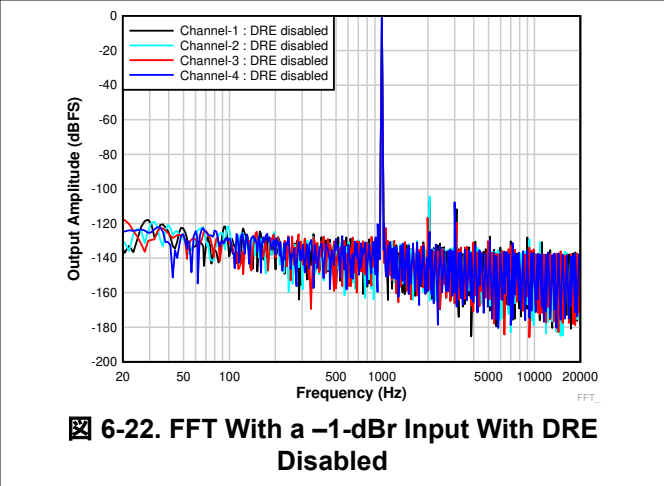
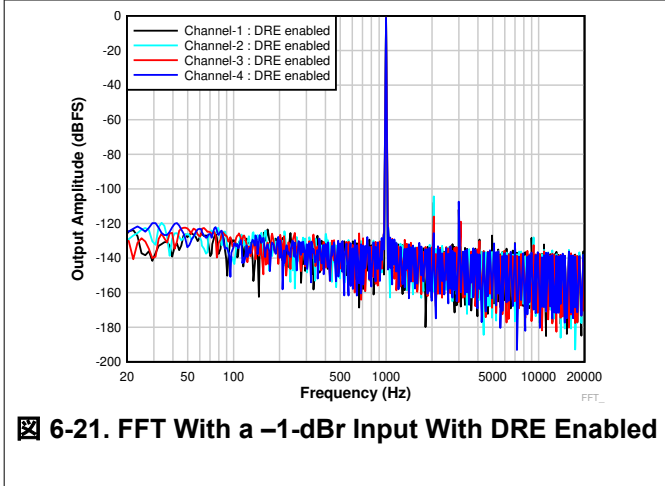

7 Detailed Description

7.1 Overview

The PCM5140-Q1 is a high-performance, low-power, flexible, quad-channel, audio analog-to-digital converter (ADC) with extensive feature integration. This device is intended for applications in voice-activated systems, professional microphones, audio conferencing, portable computing, communication, and entertainment applications. The high dynamic range of the device enables far-field audio recording with high fidelity. This device integrates a host of features that reduces cost, board space, and power consumption in space-constrained, battery-powered, consumer, home, and industrial applications.

The PCM5140-Q1 consists of the following blocks:

- Quad-channel, multibit, high-performance delta-sigma ($\Delta\Sigma$) ADC
- Configurable single-ended or differential audio inputs
- Low-noise, programmable microphone bias output
- Dynamic range enhancer (DRE) to support 120-dB dynamic range
- Automatic gain controller (AGC)
- Programmable decimation filters with linear-phase or low-latency filter
- Programmable channel gain, volume control, biquad filters for each channel
- Programmable phase and gain calibration with fine resolution for each channel
- Programmable high-pass filter (HPF), and digital channel mixer
- Pulse density modulation (PDM) digital microphone interface with high-performance decimation filter
- Integrated low-jitter phase-locked loop (PLL) supporting a wide range of system clocks
- Integrated digital and analog voltage regulators to support single-supply operation

Communication to the PCM5140-Q1 to configure the control registers is supported using an I²C or SPI interface. The device supports a highly flexible audio serial interface [time-division multiplexing (TDM), I²S, or left-justified (LJ)] to transmit audio data seamlessly in the system across devices.

The device can support multiple devices by sharing the common I²C and TDM buses across devices. Moreover, the device includes a daisy-chain feature and a secondary audio serial output data pin. These features relax the shared TDM bus timing requirements and board design complexities when operating multiple devices for applications requiring high audio data bandwidth.

表 7-1 lists the reference abbreviations used throughout this document to registers that control the device.

表 7-1. Abbreviations for Register References

| REFERENCE | ABBREVIATION | DESCRIPTION | EXAMPLE |
|------------------------------|--------------|--|---|
| Page y, register z, bit k | Py_Rz_Dk | Single data bit. The value of a single bit in a register. | Page 4, register 36, bit 0 = P4_R36_D0 |
| Page y, register z, bits k-m | Py_Rz_D[k:m] | Range of data bits. A range of data bits (inclusive). | Page 4, register 36, bits 3-0 = P4_R36_D[3:0] |
| Page y, register z | Py_Rz | One entire register. All eight bits in the register as a unit. | Page 4, register 36 = P4_R36 |
| Page y, registers z-n | Py_Rz-Rn | Range of registers. A range of registers in the same page. | Page 4, registers 36, 37, 38 = P4_R36-R38 |

7.2 Functional Block Diagram

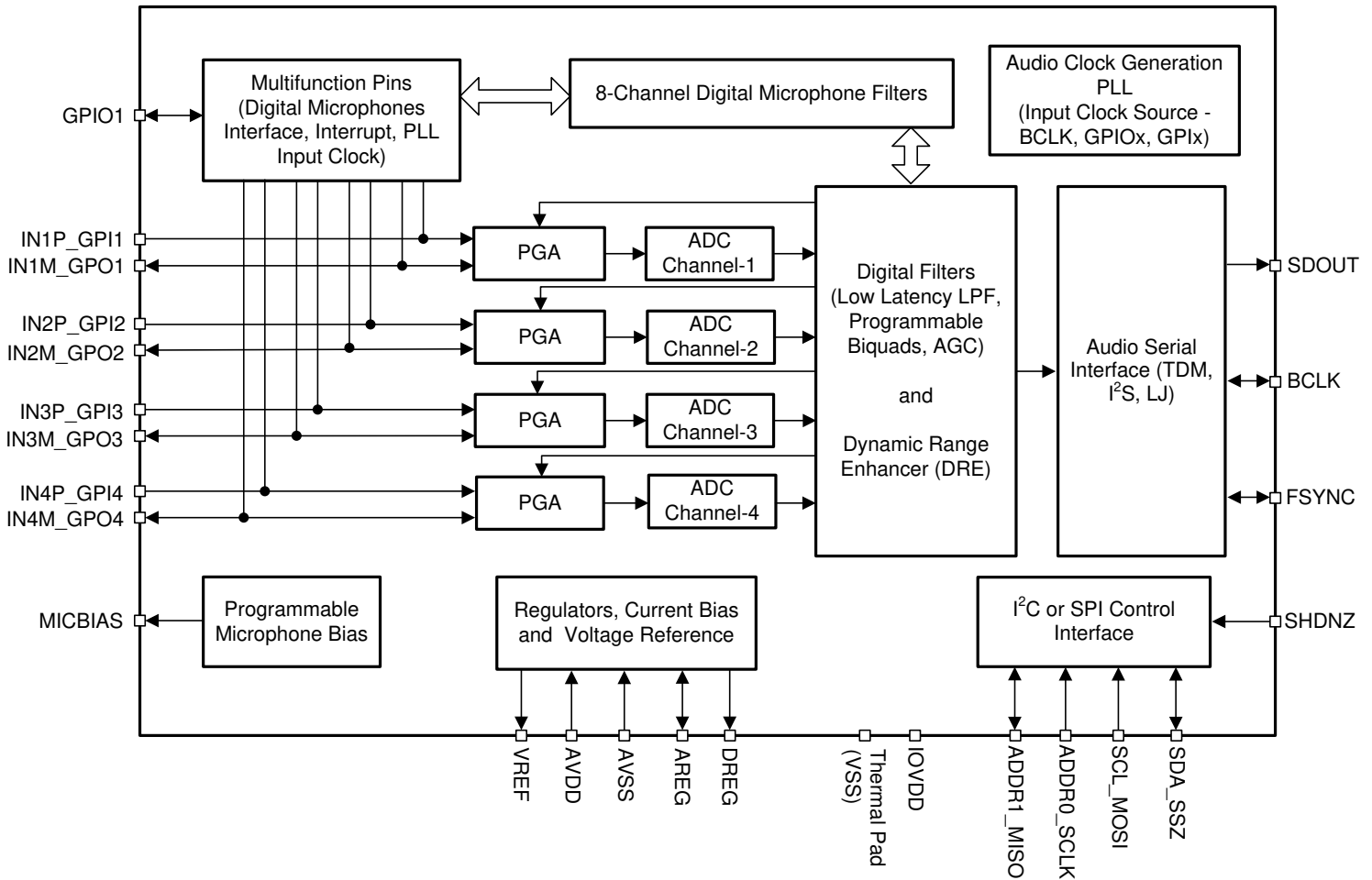

7.3 Feature Description

7.3.1 Serial Interfaces

This device has two serial interfaces: control and audio data. The control serial interface is used for device configuration. The audio data serial interface is used for transmitting audio data to the host device.

7.3.1.1 Control Serial Interfaces

The device contains configuration registers and programmable coefficients that can be set to the desired values for a specific system and application use. All these registers can be accessed using either I²C or SPI communication to the device. For more information, see the [セクション 7.5](#) section.

7.3.1.2 Audio Serial Interfaces

Digital audio data flows between the host processor and the PCM5140-Q1 on the digital audio serial interface (ASI), or audio bus. This highly flexible ASI bus includes a TDM mode for multichannel operation, support for I²S or left-justified protocols format, programmable data length options, very flexible controller-target configurability for bus clock lines and the ability to communicate with multiple devices within a system directly.

The bus protocol TDM, I²S, or left-justified (LJ) format can be selected by using the ASI_FORMAT[1:0], P0_R7_D[7:6] register bits. As shown in 表 7-2 and 表 7-3, these modes are all most significant byte (MSB)-first, pulse code modulation (PCM) data format, with the output channel data word-length programmable as 16, 20, 24, or 32 bits by configuring the ASI_WLEN[1:0], P0_R7_D[5:4] register bits.

表 7-2. Audio Serial Interface Format

| P0_R7_D[7:6] : ASI_FORMAT[1:0] | AUDIO SERIAL INTERFACE FORMAT |
|--------------------------------|--|
| 00 (default) | Time division multiplexing (TDM) mode |
| 01 | Inter IC sound (I ² S) mode |
| 10 | Left-justified (LJ) mode |
| 11 | Reserved (do not use this setting) |

表 7-3. Audio Output Channel Data Word-Length

| P0_R7_D[5:4] : ASI_WLEN[1:0] | AUDIO OUTPUT CHANNEL DATA WORD-LENGTH |
|------------------------------|--|
| 00 | Output channel data word-length set to 16 bits |
| 01 | Output channel data word-length set to 20 bits |
| 10 | Output channel data word-length set to 24 bits |
| 11 (default) | Output channel data word-length set to 32 bits |

The frame sync pin, FSYNC, is used in this audio bus protocol to define the beginning of a frame and has the same frequency as the output data sample rates. The bit clock pin, BCLK, is used to clock out the digital audio data across the serial bus. The number of bit-clock cycles in a frame must accommodate multiple device active output channels with the programmed data word length.

A frame consists of multiple time-division channel slots (up to 64) to allow all output channel audio data transmissions to complete on the audio bus by a device or multiple PCM5140-Q1 devices sharing the same audio bus. The device supports up to eight output channels that can be configured to place their audio data on bus slot 0 to slot 63. 表 7-4 lists the output channel slot configuration settings. In I²S and LJ mode, the slots are divided into two sets, left-channel slots and right-channel slots, as described in the [セクション 7.3.1.2.2](#) and [セクション 7.3.1.2.3](#) sections.

表 7-4. Output Channel Slot Assignment Settings

| P0_R11_D[5:0] : CH1_SLOT[5:0] | OUTPUT CHANNEL 1 SLOT ASSIGNMENT |
|-------------------------------|--|
| 00 0000 = 0d (default) | Slot 0 for TDM or left slot 0 for I ² S, LJ. |
| 00 0001 = 1d | Slot 1 for TDM or left slot 1 for I ² S, LJ. |
| ... | ... |
| 01 1111 = 31d | Slot 31 for TDM or left slot 31 for I ² S, LJ. |
| 10 0000 = 32d | Slot 32 for TDM or right slot 0 for I ² S, LJ. |
| ... | ... |
| 11 1110 = 62d | Slot 62 for TDM or right slot 30 for I ² S, LJ. |
| 11 1111 = 63d | Slot 63 for TDM or right slot 31 for I ² S, LJ. |

Similarly, the slot assignment setting for output channel 2 to channel 8 can be done using the CH2_SLOT (P0_R12) to CH8_SLOT (P0_R18) registers, respectively.

The slot word length is the same as the output channel data word length set for the device. The output channel data word length must be set to the same value for all PCM5140-Q1 devices if all devices share the same ASI bus in a system. The maximum number of slots possible for the ASI bus in a system is limited by the available bus bandwidth, which depends upon the BCLK frequency, output data sample rate used, and the channel data word length configured.

The device also includes a feature that offsets the start of the slot data transfer with respect to the frame sync by up to 31 cycles of the bit clock. 表 7-5 lists the programmable offset configuration settings.

表 7-5. Programmable Offset Settings for the ASI Slot Start

| P0_R8_D[4:0] : TX_OFFSET[4:0] | PROGRAMMABLE OFFSET SETTING FOR SLOT DATA TRANSMISSION START |
|-------------------------------|--|
| 0 0000 = 0d (default) | The device follows the standard protocol timing without any offset. |
| 0 0001 = 1d | Slot start is offset by one BCLK cycle, as compared to standard protocol timing. For I ² S or LJ, the left and right slot start is offset by one BCLK cycle, as compared to standard protocol timing. |
| | |
| 1 1110 = 30d | Slot start is offset by 30 BCLK cycles, as compared to standard protocol timing. For I ² S or LJ, the left and right slot start is offset by 30 BCLK cycles, as compared to standard protocol timing. |
| 1 1111 = 31d | Slot start is offset by 31 BCLK cycles, as compared to standard protocol timing. For I ² S or LJ, the left and right slot start is offset by 31 BCLK cycles, as compared to standard protocol timing. |

The device also features the ability to invert the polarity of the frame sync pin, FSYNC, used to transfer the audio data as compared to the default FSYNC polarity used in standard protocol timing. This feature can be set using the FSYNC_POL, P0_R7_D3 register bit. Similarly, the device can invert the polarity of the bit clock pin, BCLK, which can be set using the BCLK_POL, P0_R7_D2 register bit.

7.3.1.2.1 Time Division Multiplexed Audio (TDM) Interface

In TDM mode, also known as DSP mode, the rising edge of FSYNC starts the data transfer with the slot 0 data first. Immediately after the slot 0 data transmission, the remaining slot data are transmitted in order. FSYNC and each data bit (except the MSB of slot 0 when TX_OFFSET equals 0) is transmitted on the rising edge of BCLK.

図 7-1 to 図 7-4 illustrate the protocol timing for TDM operation with various configurations.



図 7-1. TDM Mode Standard Protocol Timing (TX_OFFSET = 0)



図 7-2. TDM Mode Protocol Timing (TX_OFFSET = 2)

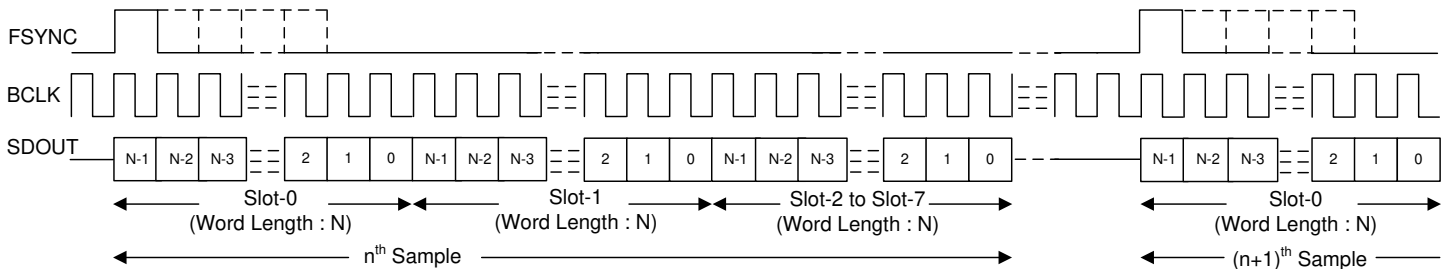

図 7-3. TDM Mode Protocol Timing (No Idle BCLK Cycles, TX_OFFSET = 2)

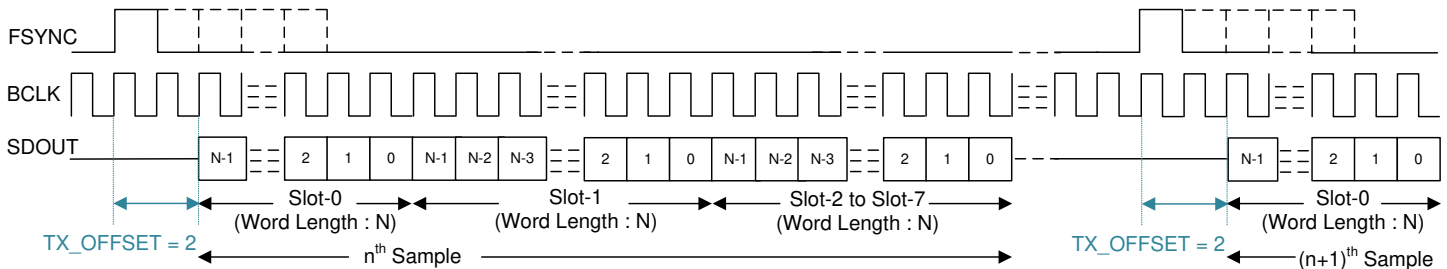

図 7-4. TDM Mode Protocol Timing (TX_OFFSET = 0 and BCLK_POL = 1)

For proper operation of the audio bus in TDM mode, the number of bit clocks per frame must be greater than or equal to the number of active output channels times the programmed word length of the output channel data. The device supports FSYNC as a pulse with a 1-cycle-wide bit clock, but also supports multiples as well. For a higher BCLK frequency operation, using TDM mode with a TX_OFFSET value higher than 0 is recommended.

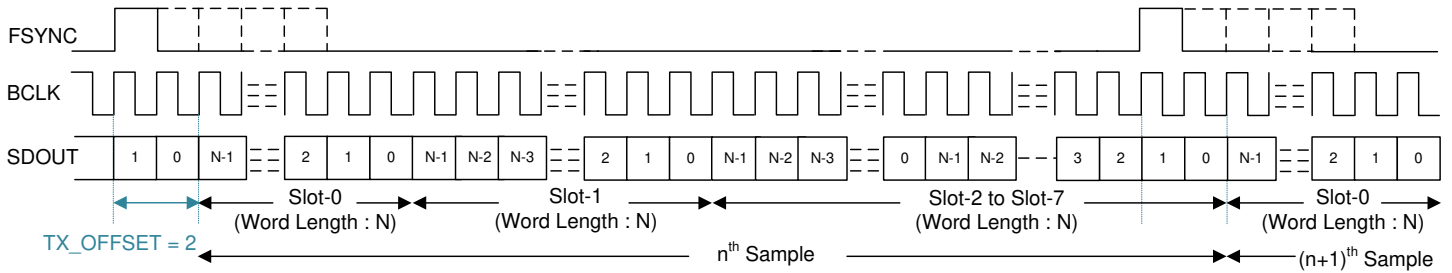
7.3.1.2.2 Inter IC Sound (I²S) Interface

The standard I²S protocol is defined for only two channels: left and right. The device extends the same protocol timing for multichannel operation. In I²S mode, the MSB of the left slot 0 is transmitted on the falling edge of BCLK in the second cycle after the *falling* edge of FSYNC. Immediately after the left slot 0 data transmission, the remaining left slot data are transmitted in order. The MSB of the right slot 0 is transmitted on the falling edge of BCLK in the second cycle after the *rising* edge of FSYNC. Immediately after the right slot 0 data transmission, the remaining right slot data are transmitted in order. FSYNC and each data bit is transmitted on the falling edge of BCLK. 図 7-5 to 図 7-8 illustrate the protocol timing for I²S operation with various configurations.

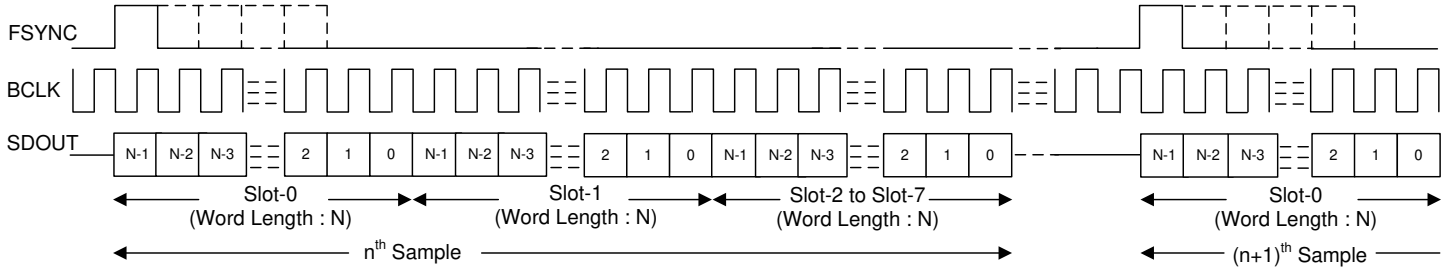

図 7-5. I²S Mode Standard Protocol Timing (TX_OFFSET = 0)



図 7-6. I²S Protocol Timing (TX_OFFSET = 1)

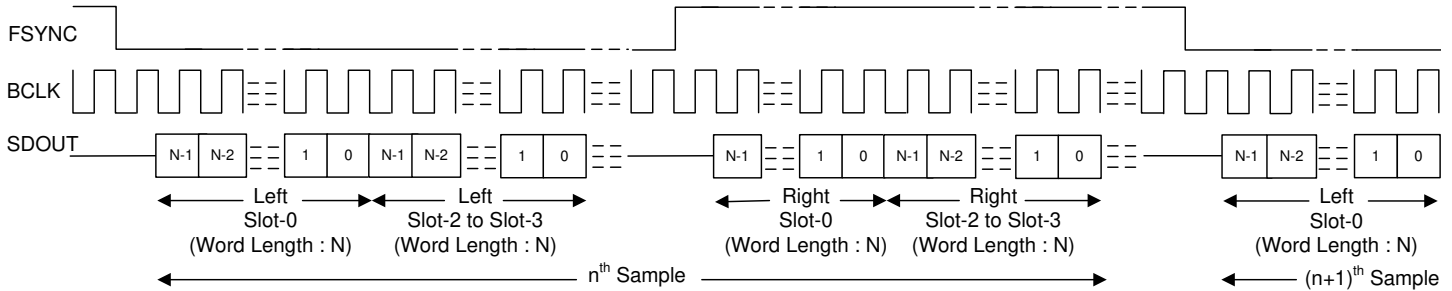

図 7-7. I²S Protocol Timing (No Idle BCLK Cycles, TX_OFFSET = 0)

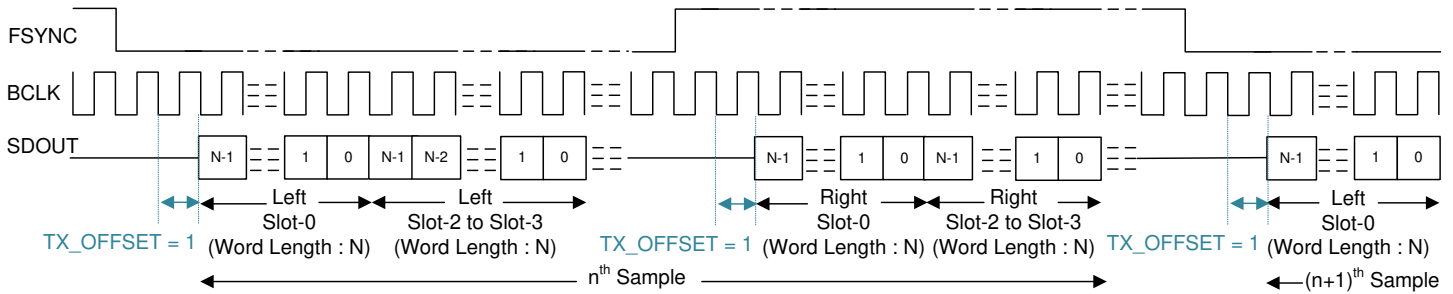

図 7-8. I²S Protocol Timing (TX_OFFSET = 0 and BCLK_POL = 1)

For proper operation of the audio bus in I²S mode, the number of bit clocks per frame must be greater than or equal to the number of active output channels (including left and right slots) times the programmed word length of the output channel data. The device FSYNC low pulse must be a number of BCLK cycles wide that is greater than or equal to the number of active left slots times the data word length configured. Similarly, the FSYNC high pulse must be a number of BCLK cycles wide that is greater than or equal to the number of active right slots times the data word length configured.

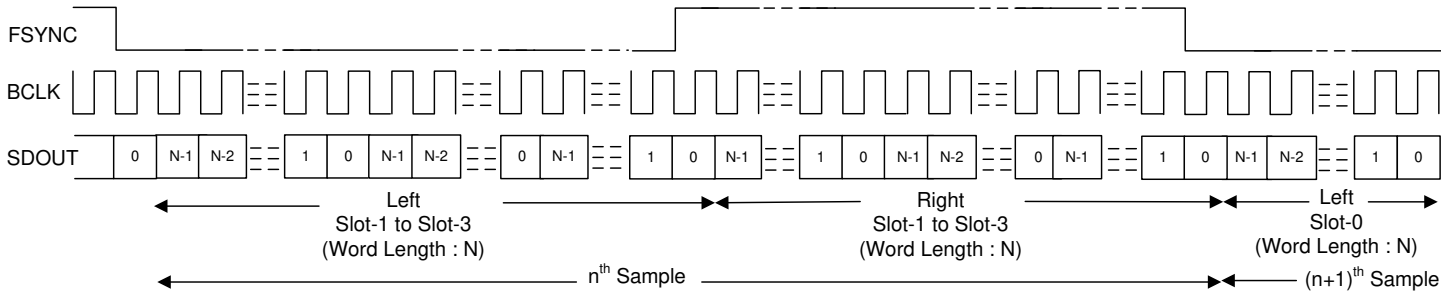
7.3.1.2.3 Left-Justified (LJ) Interface

The standard LJ protocol is defined for only two channels: left and right. The device extends the same protocol timing for multichannel operation. In LJ mode, the MSB of the left slot 0 is transmitted in the same BCLK cycle after the *rising* edge of FSYNC. Each subsequent data bit is transmitted on the falling edge of BCLK. Immediately after the left slot 0 data transmission, the remaining left slot data are transmitted in order. The MSB of the right slot 0 is transmitted in the same BCLK cycle after the *falling* edge of FSYNC. Each subsequent data bit is transmitted on the falling edge of BCLK. Immediately after the right slot 0 data transmission, the remaining right slot data are transmitted in order. FSYNC is transmitted on the falling edge of BCLK. 図 7-9 to 図 7-12 illustrate the protocol timing for LJ operation with various configurations.

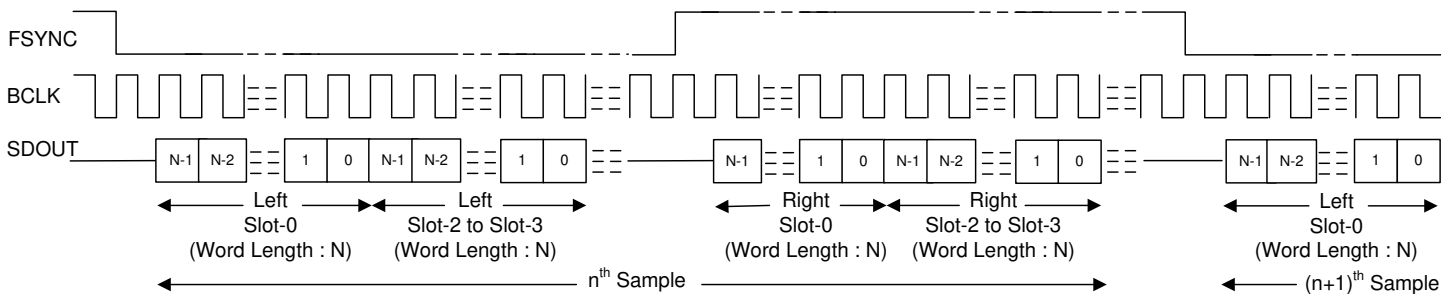

图 7-9. LJ Mode Standard Protocol Timing (TX_OFFSET = 0)



图 7-10. LJ Protocol Timing (TX_OFFSET = 2)

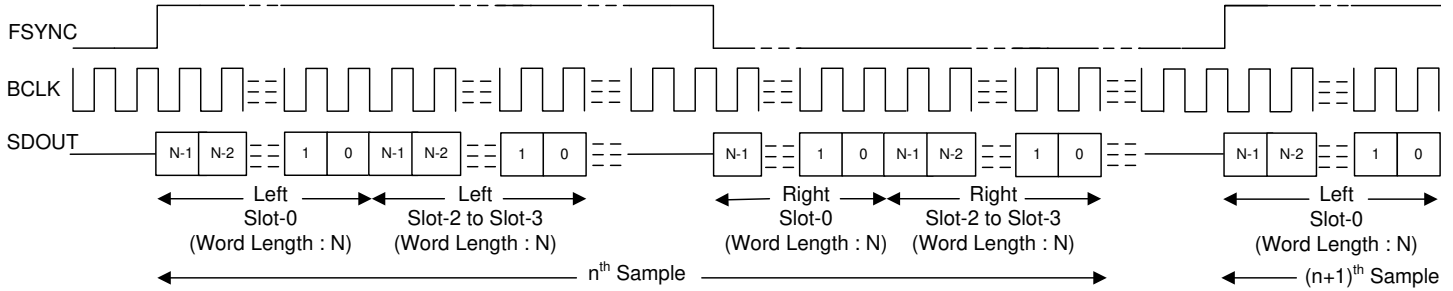

图 7-11. LJ Protocol Timing (No Idle BCLK Cycles, TX_OFFSET = 0)

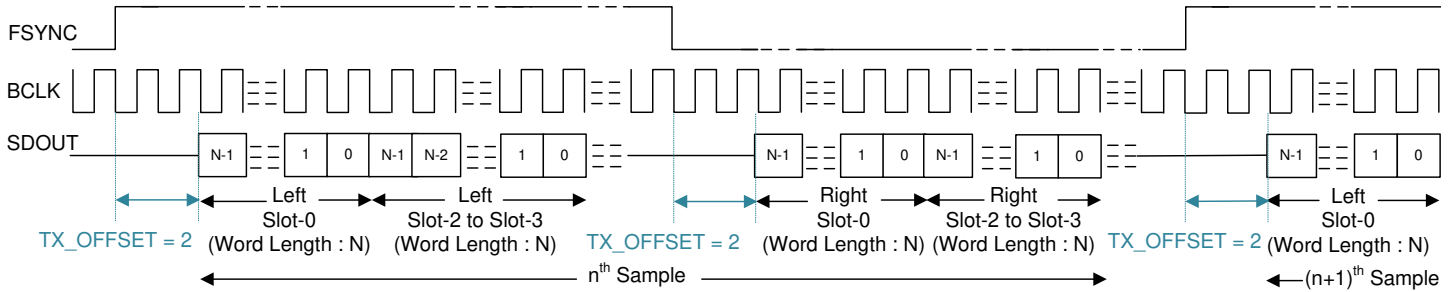

图 7-12. LJ Protocol Timing (TX_OFFSET = 1 and BCLK_POL = 1)

For proper operation of the audio bus in LJ mode, the number of bit clocks per frame must be greater than or equal to the number of active output channels (including left and right slots) times the programmed word length of the output channel data. The device FSYNC high pulse must be a number of BCLK cycles wide that is greater than or equal to the number of active left slots times the data word length configured. Similarly, the FSYNC low pulse must be number of BCLK cycles wide that is greater than or equal to the number of active right slots times the data word length configured. For a higher BCLK frequency operation, using LJ mode with a TX_OFFSET value higher than 0 is recommended.

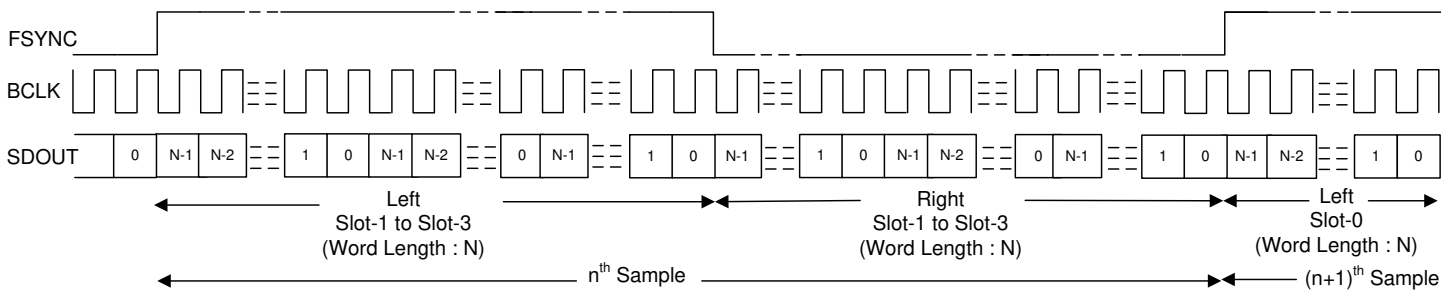
7.3.1.3 Using Multiple Devices With Shared Buses

The device has many supported features and flexible options that can be used in the system to seamlessly connect multiple PCM5140-Q1 devices by sharing a single common I²C control bus and an audio serial interface bus. This architecture enables multiple applications to be applied to a system that require a microphone array for beam-forming operation, audio conferencing, noise cancellation, and so forth. [Figure 7-13](#) shows a diagram of multiple PCM5140-Q1 devices in a configuration where the control and audio data buses are shared.

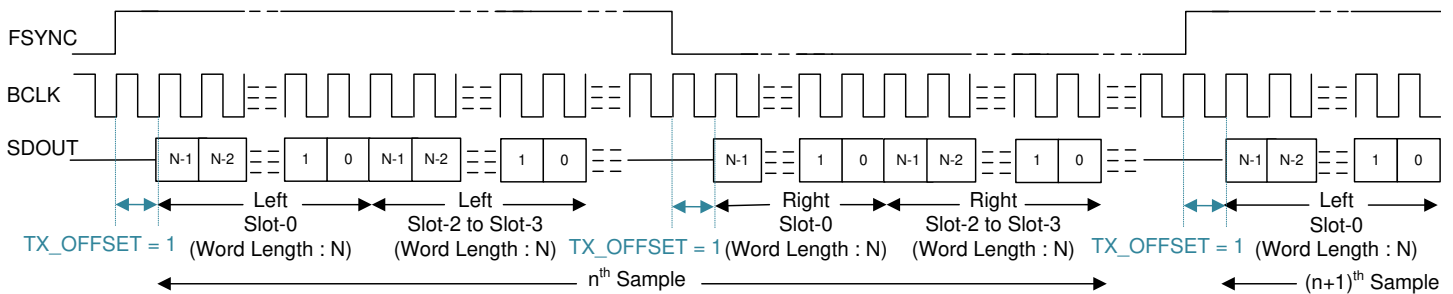
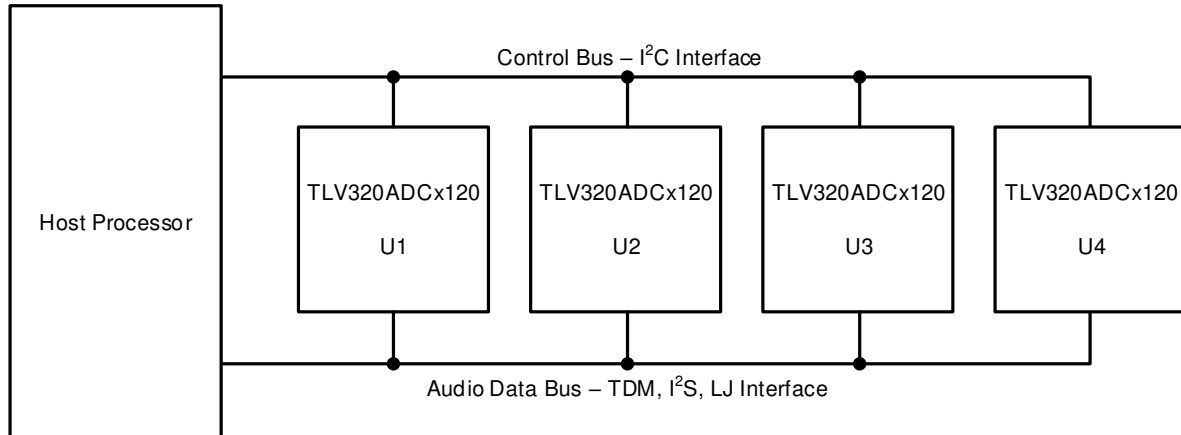

Figure 7-13. Multiple PCM5140-Q1 Devices With Shared Control and Audio Data Buses

The PCM5140-Q1 consists of the following features to enable seamless connection and interaction of multiple devices using a shared bus:

- Supports up to four pin-programmable I²C target addresses
- I²C broadcast simultaneously writes to (or triggers) all PCM5140-Q1 devices
- Supports up to 64 configuration output channel slots for the audio serial interface
- Tri-state feature (with enable and disable) for the unused audio data slots of the device
- Supports a bus-holder feature (with enable and disable) to keep the last driven value on the audio bus
- The GPIO1 or GPOx pin can be configured as a secondary output data lane for the audio serial interface
- The GPIO1 or GPIx pin can be used in a daisy-chain configuration of multiple PCM5140-Q1 devices
- Supports one BCLK cycle data latching timing to relax the timing requirement for the high-speed interface
- Programmable controller and target options for the audio serial interface
- Ability to synchronize the multiple devices for the simultaneous sampling requirement across devices

See the [Multiple TLV320ADCx140 Devices With a Shared TDM and I²C Bus application report](#) for further details.

7.3.2 Phase-Locked Loop (PLL) and Clock Generation

The device has a smart auto-configuration block to generate all necessary internal clocks required for the ADC modulator and the digital filter engine used for signal processing. This configuration is done by monitoring the frequency of the FSYNC and BCLK signal on the audio bus.

The device supports the various output data sample rates (of the FSYNC signal frequency) and the BCLK to FSYNC ratio to configure all clock dividers, including the PLL configuration, internally without host programming. 表 7-6 and 表 7-7 list the supported FSYNC and BCLK frequencies.

表 7-6. Supported FSYNC (Multiples or Submultiples of 48 kHz) and BCLK Frequencies

| BCLK TO FSYNC RATIO | BCLK (MHz) | | | | | | | | |
|---------------------|---------------|----------------|----------------|----------------|----------------|----------------|-----------------|-----------------|-----------------|
| | FSYNC (8 kHz) | FSYNC (16 kHz) | FSYNC (24 kHz) | FSYNC (32 kHz) | FSYNC (48 kHz) | FSYNC (96 kHz) | FSYNC (192 kHz) | FSYNC (384 kHz) | FSYNC (768 kHz) |
| 16 | Reserved | 0.256 | 0.384 | 0.512 | 0.768 | 1.536 | 3.072 | 6.144 | 12.288 |
| 24 | Reserved | 0.384 | 0.576 | 0.768 | 1.152 | 2.304 | 4.608 | 9.216 | 18.432 |
| 32 | 0.256 | 0.512 | 0.768 | 1.024 | 1.536 | 3.072 | 6.144 | 12.288 | 24.576 |
| 48 | 0.384 | 0.768 | 1.152 | 1.536 | 2.304 | 4.608 | 9.216 | 18.432 | Reserved |
| 64 | 0.512 | 1.024 | 1.536 | 2.048 | 3.072 | 6.144 | 12.288 | 24.576 | Reserved |
| 96 | 0.768 | 1.536 | 2.304 | 3.072 | 4.608 | 9.216 | 18.432 | Reserved | Reserved |
| 128 | 1.024 | 2.048 | 3.072 | 4.096 | 6.144 | 12.288 | 24.576 | Reserved | Reserved |
| 192 | 1.536 | 3.072 | 4.608 | 6.144 | 9.216 | 18.432 | Reserved | Reserved | Reserved |
| 256 | 2.048 | 4.096 | 6.144 | 8.192 | 12.288 | 24.576 | Reserved | Reserved | Reserved |
| 384 | 3.072 | 6.144 | 9.216 | 12.288 | 18.432 | Reserved | Reserved | Reserved | Reserved |
| 512 | 4.096 | 8.192 | 12.288 | 16.384 | 24.576 | Reserved | Reserved | Reserved | Reserved |
| 1024 | 8.192 | 16.384 | 24.576 | Reserved | Reserved | Reserved | Reserved | Reserved | Reserved |
| 2048 | 16.384 | Reserved | Reserved | Reserved | Reserved | Reserved | Reserved | Reserved | Reserved |

表 7-7. Supported FSYNC (Multiples or Submultiples of 44.1 kHz) and BCLK Frequencies

| BCLK TO FSYNC RATIO | BCLK (MHz) | | | | | | | | |
|---------------------|------------------|------------------|-------------------|------------------|------------------|------------------|-------------------|-------------------|-------------------|
| | FSYNC (7.35 kHz) | FSYNC (14.7 kHz) | FSYNC (22.05 kHz) | FSYNC (29.4 kHz) | FSYNC (44.1 kHz) | FSYNC (88.2 kHz) | FSYNC (176.4 kHz) | FSYNC (352.8 kHz) | FSYNC (705.6 kHz) |
| 16 | Reserved | Reserved | 0.3528 | 0.4704 | 0.7056 | 1.4112 | 2.8224 | 5.6448 | 11.2896 |
| 24 | Reserved | 0.3528 | 0.5292 | 0.7056 | 1.0584 | 2.1168 | 4.2336 | 8.4672 | 16.9344 |
| 32 | Reserved | 0.4704 | 0.7056 | 0.9408 | 1.4112 | 2.8224 | 5.6448 | 11.2896 | 22.5792 |
| 48 | 0.3528 | 0.7056 | 1.0584 | 1.4112 | 2.1168 | 4.2336 | 8.4672 | 16.9344 | Reserved |
| 64 | 0.4704 | 0.9408 | 1.4112 | 1.8816 | 2.8224 | 5.6448 | 11.2896 | 22.5792 | Reserved |
| 96 | 0.7056 | 1.4112 | 2.1168 | 2.8224 | 4.2336 | 8.4672 | 16.9344 | Reserved | Reserved |
| 128 | 0.9408 | 1.8816 | 2.8224 | 3.7632 | 5.6448 | 11.2896 | 22.5792 | Reserved | Reserved |
| 192 | 1.4112 | 2.8224 | 4.2336 | 5.6448 | 8.4672 | 16.9344 | Reserved | Reserved | Reserved |
| 256 | 1.8816 | 3.7632 | 5.6448 | 7.5264 | 11.2896 | 22.5792 | Reserved | Reserved | Reserved |
| 384 | 2.8224 | 5.6448 | 8.4672 | 11.2896 | 16.9344 | Reserved | Reserved | Reserved | Reserved |
| 512 | 3.7632 | 7.5264 | 11.2896 | 15.0528 | 22.5792 | Reserved | Reserved | Reserved | Reserved |
| 1024 | 7.5264 | 15.0528 | 22.5792 | Reserved | Reserved | Reserved | Reserved | Reserved | Reserved |
| 2048 | 15.0528 | Reserved | Reserved | Reserved | Reserved | Reserved | Reserved | Reserved | Reserved |

The status register ASI_STS, P0_R21, captures the device auto detect result for the FSYNC frequency and the BCLK to FSYNC ratio. If the device finds any unsupported combinations of FSYNC frequency and BCLK to FSYNC ratios, the device generates an ASI clock-error interrupt and mutes the record channels accordingly.

The device uses an integrated, low-jitter, phase-locked loop (PLL) to generate internal clocks required for the ADC modulator and digital filter engine, as well as other control blocks. The device also supports an option to use BCLK, GPIO1, or the GPIx pin (as MCLK) as the audio clock source without using the PLL to reduce power consumption. However, the ADC performance may degrade based on jitter from the external clock source, and some processing features may not be supported if the external audio clock source frequency is not high enough. Therefore, TI recommends using the PLL for high-performance applications. More details and information on how to configure and use the device in low-power mode without using the PLL are discussed in the [TLV320ADCx140 Operation for Low-Power Critical Applications application report](#).

The device also supports an audio bus controller mode operation using the GPIO1 or GPIx pin (as MCLK) as the reference input clock source and supports various flexible options and a wide variety of system clocks. More details and information on controller mode configuration and operation are discussed in the [Configuring and Operating the TLV320ADCx140 as an Audio Bus Master application report](#).

The audio bus clock error detection and auto-detect feature automatically generates all internal clocks, but can be disabled using the ASI_ERR, P0_R9_D5 and AUTO_CLK_CFG, P0_R19_D6, register bits, respectively. In the system, this disable feature can be used to support custom clock frequencies that are not covered by the auto detect scheme. For such application use cases, care must be taken to ensure that the multiple clock dividers are all configured appropriately. Therefore, TI recommends using the PPC3 GUI for device configuration settings; for more details see the [TLV320ADCx140 Evaluation module user's guide](#) and the [PurePath™ console graphical development suite](#).

7.3.3 Input Channel Configurations

The device consists of four pairs of analog input pins (INxP and INxM) that can be configured as differential inputs or single-ended inputs for the recording channel. The device supports simultaneous recording of up to four channels using the high-performance multichannel ADC. The input source for the analog pins can be from electret condenser analog microphones, microelectrical-mechanical system (MEMS) analog microphones, or line-in (auxiliary) inputs from the system board. Additionally, if the application uses digital PDM microphones for the recording, then the INxP and INxM pins can be reconfigured in the device to support up to eight channels for the digital microphone recording. 表 7-8 shows the input source selection for the record channel.

表 7-8. Input Source Selection for the Record Channel

| P0_R60_D[6:5] : CH1_INSRC[1:0] | INPUT CHANNEL 1 RECORD SOURCE SELECTION |
|--------------------------------|--|
| 00 (default) | Analog differential input for channel 1 (this setting is valid only when the GPI1 and GPO1 pin functions are disabled) |
| 01 | Analog single-ended Input for channel 1 (this setting is valid only when the GPI1 and GPO1 pin functions are disabled) |
| 10 | Digital PDM input for channel 1 (configure the GPIx and GPOx pin accordingly for PDMIN1 and PDMCLK) |
| 11 | Reserved (do not use this setting) |

Similarly, the input source selection setting for input channel 2, channel 3, and channel 4 can be configured using the CH2_INSRC[1:0] (P0_R65_D[6:5]), CH3_INSRC[1:0] (P0_R70_D[6:5]), and CH4_INSRC[1:0] (P0_R75_D[6:5]) register bits, respectively.

Typically, voice or audio signal inputs are capacitively coupled (AC-coupled) to the device; however, the device also supports an option for DC-coupled inputs to save board space. This configuration can be done independently for each channel by setting the CH1_DC (P0_R60_D4), CH2_DC (P0_R65_D4), CH3_DC (P0_R70_D4), and CH4_DC (P0_R75_D4) register bits. The INM pin can be directly grounded in DC-coupled mode (see [Figure 7-14](#)), but the INM pin must be grounded after the AC-coupling capacitor in AC-coupled mode (see [Figure 7-15](#)) for the single-ended input configuration. For the best dynamic range performance, the differential AC-coupled input must be used with the DRE enabled.



图 7-14. Single-Ended DC-Coupled Input Connection



图 7-15. Single-Ended AC-Coupled Input Connection

The device allows for flexibility in choosing the typical input impedance on INxP or INxM from 2.5 k Ω (default), 10 k Ω , and 20 k Ω based on the input source impedance. The higher input impedance results in slightly higher noise or lower dynamic range. 表 7-9 lists the configuration register settings for the input impedance for the record channel.

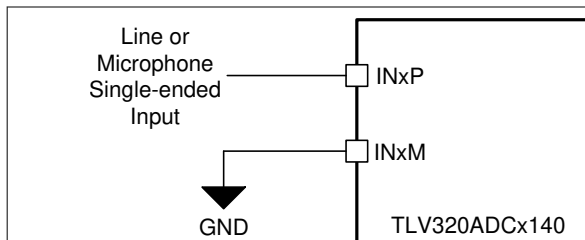
表 7-9. Input Impedance Selection for the Record Channel

| P0_R60_D[3:2] : CH1_IMP[1:0] | CHANNEL 1 INPUT IMPEDANCE SELECTION |
|------------------------------|---|
| 00 (default) | Channel 1 input impedance typical value is 2.5 k Ω on INxP or INxM |
| 01 | Channel 1 input impedance typical value is 10 k Ω on INxP or INxM |
| 10 | Channel 1 input impedance typical value is 20 k Ω on INxP or INxM |
| 11 | Reserved (do not use this setting) |

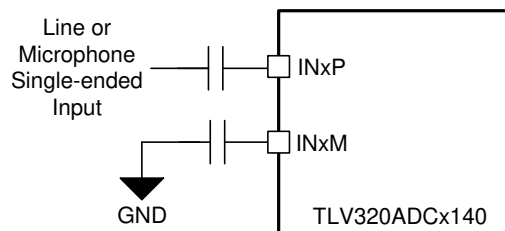
Similarly, the input impedance selection setting for input channel 2, channel 3, and channel 4 can be configured using the CH2_IMP[1:0] (P0_R65_D[3:2]), CH3_IMP[1:0] (P0_R70_D[3:2]), and CH4_IMP[1:0] (P0_R75_D[3:2]) register bits, respectively.

The value of the coupling capacitor in AC-coupled mode must be chosen so that the high-pass filter formed by the coupling capacitor and the input impedance do not affect the signal content. Before proper recording can begin, this coupling capacitor must be charged up to the common-mode voltage at power-up. To enable quick charging, the device has modes to speed up the charging of the coupling capacitor. The default value of the quick-charge timing is set for a coupling capacitor up to 1 μ F. However, if a higher-value capacitor is used in the system, then the quick-charging timing can be increased by using the INCAP_QCHG (P0_R5_D[5:4]) register bits. For best distortion performance, use the low-voltage coefficient capacitors for AC coupling. The input impedance value of 2.5 k Ω is not supported for the DC-coupled input.

7.3.4 Reference Voltage

All audio data converters require a DC reference voltage. The PCM5140-Q1 achieves low-noise performance by internally generating a low-noise reference voltage. This reference voltage is generated using a band-gap circuit with high PSRR performance. This audio converter reference voltage must be filtered externally using a minimum 1- μ F capacitor connected from the VREF pin to the analog ground (AVSS).

The value of this reference voltage can be configured using the P0_R59_D[1:0] register bits and must be set to an appropriate value based on the desired full-scale input for the device and the AVDD supply voltage available in the system. The default VREF value is set to 2.75 V, which in turn supports a 2- V_{RMS} differential full-scale input to the device. The required minimum AVDD voltage for this mode is 3 V. 表 7-10 lists the various VREF settings supported along with the required AVDD range and the supported full-scale input signal for that configuration.

表 7-10. VREF Programmable Settings

| P0_R59_D[1:0] : ADC_FSCALE[1:0] | VREF OUTPUT VOLTAGE (Same as Internal ADC VREF) | DIFFERENTIAL FULL-SCALE INPUT SUPPORTED | SINGLE-ENDED FULL-SCALE INPUT SUPPORTED | AVDD RANGE REQUIREMENT |
|---------------------------------|---|---|---|------------------------|
| 00 (default) | 2.75 V | 2 V_{RMS} | 1 V_{RMS} | 3 V to 3.6 V |

表 7-10. VREF Programmable Settings (続き)

| P0_R59_D[1:0] : ADC_FSCALE[1:0] | VREF OUTPUT VOLTAGE (Same as Internal ADC VREF) | DIFFERENTIAL FULL- SCALE INPUT SUPPORTED | SINGLE-ENDED FULL- SCALE INPUT SUPPORTED | AVDD RANGE REQUIREMENT |
|------------------------------------|---|--|--|---------------------------|
| 01 | 2.5 V | 1.818 V _{RMS} | 0.909 V _{RMS} | 2.8 V to 3.6 V |
| 10 | 1.375 V | 1 V _{RMS} | 0.5 V _{RMS} | 1.7 V to 1.9 V |
| 11 | Reserved | Reserved | Reserved | Reserved |

To achieve low-power consumption, this audio reference block is powered down as described in the [セクション 7.4.2](#) section. When exiting sleep mode, the audio reference block is powered up using the internal fast-charge scheme and the VREF pin settles to its steady-state voltage after the settling time (a function of the decoupling capacitor on the VREF pin). This time is approximately equal to 3.5 ms when using a 1-μF decoupling capacitor. If a higher-value decoupling capacitor is used on the VREF pin, the fast-charge setting must be reconfigured using the VREF_QCHG, P0_R2_D[4:3] register bits, which support options of 3.5 ms (default), 10 ms, 50 ms, or 100 ms.

7.3.5 Programmable Microphone Bias

The device integrates a built-in, low-noise microphone bias pin that can be used in the system for biasing electret-condenser microphones or providing the supply to the MEMS analog or digital microphone. The integrated bias amplifier supports up to 20 mA of load current that can be used for multiple microphones and is designed to provide a combination of high PSRR, low noise, and programmable bias voltages to allow the biasing to be fine tuned for specific microphone combinations.

When using this MICBIAS pin for biasing or supplying to multiple microphones, avoid any common impedance on the board layout for the MICBIAS connection to minimize coupling across microphones. [表 7-11](#) shows the available microphone bias programmable options.

表 7-11. MICBIAS Programmable Settings

| P0_R59_D[6:4] : MBIAS_VAL[2:0] | P0_R59_D[1:0] : ADC_FSCALE[1:0] | MICBIAS OUTPUT VOLTAGE |
|--------------------------------|---------------------------------|---------------------------------------|
| 000 (default) | 00 (default) | 2.75 V (same as the VREF output) |
| | 01 | 2.5 V (same as the VREF output) |
| | 10 | 1.375 V (same as the VREF output) |
| 001 | 00 (default) | 3.014 V (1.096 times the VREF output) |
| | 01 | 2.740 V (1.096 times the VREF output) |
| | 10 | 1.507 V (1.096 times the VREF output) |
| 010 to 101 | XX | Reserved (do not use these settings) |
| 110 | XX | Same as AVDD |
| 111 | XX | Reserved (do not use this setting) |

The microphone bias output can be powered on or powered off (default) by configuring the MICBIAS_PDZ, P0_R117_D7 register bit. Additionally, the device provides an option to configure the GPIO1 or GPIO pin to directly control the microphone bias output powering on or off. This feature is useful to control the microphone directly without engaging the host for I²C or SPI communication. The MICBIAS_PDZ, P0_R117_D7 register bit value is ignored if the GPIO1 or GPIO pin is configured to set the microphone bias on or off.

7.3.6 Signal-Chain Processing

The PCM5140-Q1 signal chain is comprised of very-low-noise, high-performance, and low-power analog blocks and highly flexible and programmable digital processing blocks. The high performance and flexibility combined with a compact package makes the PCM5140-Q1 optimized for a variety of end-equipments and applications that require multichannel audio capture. [Figure 7-16](#) shows a conceptual block diagram that highlights the various building blocks used in the signal chain, and how the blocks interact in the signal chain.

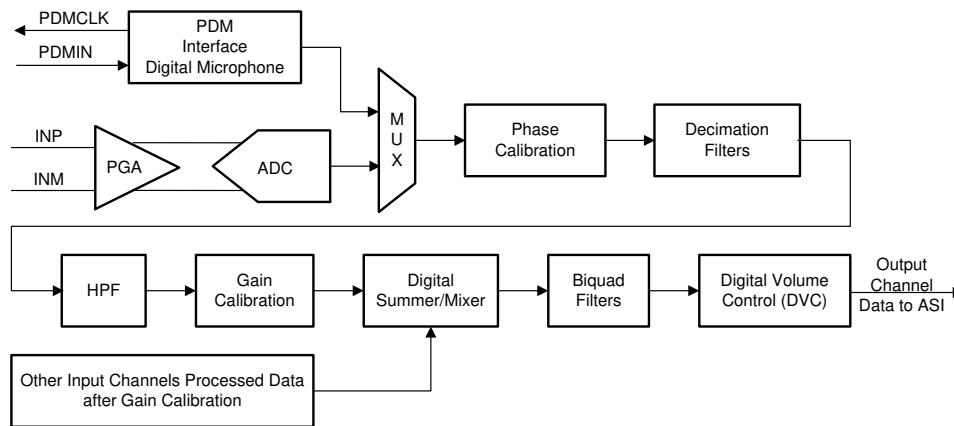

Figure 7-16. Signal-Chain Processing Flowchart

The front-end PGA is very low noise, with a 120-dB dynamic range performance. Along with a low-noise and low-distortion, multibit, delta-sigma ADC, the front-end PGA enables the PCM5140-Q1 to record a far-field audio signal with very high fidelity, both in quiet and loud environments. Moreover, the ADC architecture has inherent antialias filtering with a high rejection of out-of-band frequency noise around multiple modulator frequency components. Therefore, the device prevents noise from aliasing into the audio band during ADC sampling. Further on in the signal chain, an integrated, high-performance multistage digital decimation filter sharply cuts off any out-of-band frequency noise with high stop-band attenuation.

The device also has an integrated programmable biquad filter that allows for custom low-pass, high-pass, or any other desired frequency shaping. Thus, the overall signal chain architecture removes the requirement to add external components for antialiasing low-pass filtering, and thus saves drastically on the external system component cost and board space. See the [TLV320ADCx140 Integrated Analog Antialiasing Filter and Flexible Digital Filter application report](#) for further details.

The signal chain also consists of various highly programmable digital processing blocks such as phase calibration, gain calibration, high-pass filter, digital summer or mixer, biquad filters, and volume control. The details of these processing blocks are discussed further in this section. The device also supports up to eight digital PDM microphone recording channels when the analog recording channels are not used. Channels 1 to 4 in the signal chain block diagram of [Figure 7-16](#) is as described in this section, however, channels 5 to 8 only support the digital microphone recording option and do not support the digital summer or mixer option.

The desired input channels for recording can be enabled or disabled by using the IN_CH_EN (P0_R115) register, and the output channels for the audio serial interface can be enabled or disabled by using the ASI_OUT_EN (P0_R116) register. In general, the device supports simultaneous power-up and power-down of all active channels for simultaneous recording. However, based on the application needs, if some channels must be powered-up or powered-down dynamically when the other channel recording is on, then that use case is supported by setting the DYN_CH_PUPD_EN, P0_R117_D4 register bit to 1'b1 but do not power-down channel 1 in this mode of operation.

The device supports an input signal bandwidth of up to 80 kHz, which allows the high-frequency non-audio signal to be recorded by using a 176.4-kHz (or higher) sample rate.

For output sample rates of 48 kHz or lower, the device supports all features for 8-channel recording and various programmable processing blocks. However, for output sample rates higher than 48 kHz, there are limitations in the number of simultaneous channel recordings supported and the number of biquad filters and such. See the [TLV320ADCx140 Sampling Rates and Programmable Processing Blocks Supported application report](#) for further details.

7.3.6.1 Programmable Channel Gain and Digital Volume Control

The device has an independent programmable channel gain setting for each input channel that can be set to the appropriate value based on the maximum input signal expected in the system and the ADC VREF setting used (see the [セクション 7.3.4](#) section), which determines the ADC full-scale signal level.

Configure the desired channel gain setting before powering up the ADC channel and do not change this setting while the ADC is powered on. The programmable range supported for each channel gain is from 0 dB to 42 dB in steps of 1 dB. To achieve low-noise performance, the device internal logic first maximizes the gain for the front-end low-noise analog PGA, which supports a dynamic range of 120 dB, and then applies any residual programmed channel gain in the digital processing block.

表 7-12 shows the programmable options available for the channel gain.

表 7-12. Channel Gain Programmable Settings

| P0_R61_D[7:2] : CH1_GAIN[5:0] | CHANNEL GAIN SETTING FOR INPUT CHANNEL 1 |
|---------------------------------|--|
| 00 0000 = 0d (default) | Input channel 1 gain is set to 0 dB |
| 00 0001 = 1d | Input channel 1 gain is set to 1 dB |
| 00 0010 = 2d | Input channel 1 gain is set to 2 dB |
| ... | ... |
| 10 1001 = 41d | Input channel 1 gain is set to 41 dB |
| 10 1010 = 42d | Input channel 1 gain is set to 42 dB |
| 10 1011 to 11 1111 = 43d to 63d | Reserved (do not use these settings) |

Similarly, the channel gain setting for input channel 2, channel 3, and channel 4 can be configured using the CH2_GAIN (P0_R66), CH3_GAIN (P0_R71), and CH4_GAIN (P0_R76) register bits, respectively. The channel gain feature is not available for the digital microphone record path.

The device also has a programmable digital volume control with a range from –100 dB to 27 dB in steps of 0.5 dB with the option to mute the channel recording. The digital volume control value can be changed dynamically while the ADC channel is powered-up and recording. During volume control changes, the soft ramp-up or ramp-down volume feature is used internally to avoid any audible artifacts. Soft-stepping can be entirely disabled using the DISABLE_SOFT_STEP (P0_R108_D4) register bit.

The digital volume control setting is independently available for each output channel, including the digital microphone record channel. However, the device also supports an option to gang-up the volume control setting for all channels together using the channel 1 digital volume control setting, regardless if channel 1 is powered up or powered down. This gang-up can be enabled using the DVOL_GANG (P0_R108_D7) register bit.

表 7-13 shows the programmable options available for the digital volume control.

表 7-13. Digital Volume Control (DVC) Programmable Settings

| P0_R62_D[7:0] : CH1_DVOL[7:0] | DVC SETTING FOR OUTPUT CHANNEL 1 |
|-------------------------------|---|
| 0000 0000 = 0d | Output channel 1 DVC is set to mute |
| 0000 0001 = 1d | Output channel 1 DVC is set to –100 dB |
| 0000 0010 = 2d | Output channel 1 DVC is set to –99.5 dB |
| 0000 0011 = 3d | Output channel 1 DVC is set to –99 dB |
| ... | ... |
| 1100 1000 = 200d | Output channel 1 DVC is set to –0.5 dB |

表 7-13. Digital Volume Control (DVC) Programmable Settings (続き)

| P0_R62_D[7:0] : CH1_DVOL[7:0] | DVC SETTING FOR OUTPUT CHANNEL 1 |
|-------------------------------|--|
| 1100 1001 = 201d (default) | Output channel 1 DVC is set to 0 dB |
| 1100 1010 = 202d | Output channel 1 DVC is set to 0.5 dB |
| ... | ... |
| 1111 1101 = 253d | Output channel 1 DVC is set to 26 dB |
| 1111 1110 = 254d | Output channel 1 DVC is set to 26.5 dB |
| 1111 1111 = 255d | Output channel 1 DVC is set to 27 dB |

Similarly, the digital volume control setting for output channel 2 to channel 8 can be configured using the CH2_DVOL (P0_R67) to CH8_DVOL (P0_R97) register bits, respectively.

The internal digital processing engine soft ramps up the volume from a muted level to the programmed volume level when the channel is powered up, and the internal digital processing engine soft ramps down the volume from a programmed volume to mute when the channel is powered down. This soft-stepping of volume is done to prevent abruptly powering up and powering down the record channel. This feature can also be entirely disabled using the DISABLE_SOFT_STEP (P0_R108_D4) register bit.

7.3.6.2 Programmable Channel Gain Calibration

Along with the programmable channel gain and digital volume, this device also provides programmable channel gain calibration. The gain of each channel can be finely calibrated or adjusted in steps of 0.1 dB for a range of –0.8-dB to 0.7-dB gain error. This adjustment is useful when trying to match the gain across channels resulting from external components and microphone sensitivity. This feature, in combination with the regular digital volume control, allows the gains across all channels to be matched for a wide gain error range with a resolution of 0.1 dB. 表 7-14 shows the programmable options available for the channel gain calibration.

表 7-14. Channel Gain Calibration Programmable Settings

| P0_R63_D[7:4] : CH1_GCAL[3:0] | CHANNEL GAIN CALIBRATION SETTING FOR INPUT CHANNEL 1 |
|-------------------------------|--|
| 0000 = 0d | Input channel 1 gain calibration is set to –0.8 dB |
| 0001 = 1d | Input channel 1 gain calibration is set to –0.7 dB |
| ... | ... |
| 1000 = 8d (default) | Input channel 1 gain calibration is set to 0 dB |
| ... | ... |
| 1110 = 14d | Input channel 1 gain calibration is set to 0.6 dB |
| 1111 = 15d | Input channel 1 gain calibration is set to 0.7 dB |

Similarly, the channel gain calibration setting for input channel 2 to channel 8 can be configured using the CH2_GCAL (P0_R68) to CH8_GCAL (P0_R98) register bits, respectively.

7.3.6.3 Programmable Channel Phase Calibration

In addition to the gain calibration, the phase delay in each channel can be finely calibrated or adjusted in steps of one modulator clock cycle for a cycle range of 0 to 255 for the phase error. The modulator clock, the same clock used for ADC_MOD_CLK, is 6.144 MHz (the output data sample rate is multiples or submultiples of 48 kHz) or 5.6448 MHz (the output data sample rate is multiples or submultiples of 44.1 kHz) irrespective of the analog microphone or digital microphone use case. This feature is very useful for many applications that must match the phase with fine resolution between each channel, including any phase mismatch across channels resulting from external components or microphones. 表 7-15 shows the available programmable options for channel phase calibration.

表 7-15. Channel Phase Calibration Programmable Settings

| P0_R64_D[7:0] : CH1_PCAL[7:0] | CHANNEL PHASE CALIBRATION SETTING FOR INPUT CHANNEL 1 |
|-------------------------------|---|
| 0000 0000 = 0d (default) | Input channel 1 phase calibration with no delay |

表 7-15. Channel Phase Calibration Programmable Settings (続き)

| P0_R64_D[7:0] : CH1_PCAL[7:0] | CHANNEL PHASE CALIBRATION SETTING FOR INPUT CHANNEL 1 |
|-------------------------------|---|
| 0000 0001 = 1d | Input channel 1 phase calibration delay is set to one cycle of the modulator clock |
| 0000 0010 = 2d | Input channel 1 phase calibration delay is set to two cycles of the modulator clock |
| ... | ... |
| 1111 1110 = 254d | Input channel 1 phase calibration delay is set to 254 cycles of the modulator clock |
| 1111 1111 = 255d | Input channel 1 phase calibration delay is set to 255 cycles of the modulator clock |

Similarly, the channel phase calibration setting for input channel 2 to channel 8 can be configured using the CH2_PCAL (P0_R69) to CH8_PCAL (P0_R99) register bits, respectively.

The phase calibration feature must not be used when the analog input and PDM input are used together for simultaneous conversion.

7.3.6.4 Programmable Digital High-Pass Filter

To remove the DC offset component and attenuate the undesired low-frequency noise content in the record data, the device supports a programmable high-pass filter (HPF). The HPF is not a channel-independent filter setting but is globally applicable for all ADC channels. This HPF is constructed using the first-order infinite impulse response (IIR) filter, and is efficient enough to filter out possible DC components of the signal. 表 7-16 shows the predefined -3 -dB cutoff frequencies available that can be set by using the HPF_SEL[1:0] register bits of P0_R107. Additionally, to achieve a custom -3 -dB cutoff frequency for a specific application, the device also allows the first-order IIR filter coefficients to be programmed when the HPF_SEL[1:0] register bits are set to 2'b00. 図 7-17 illustrates a frequency response plot for the HPF filter.

表 7-16. HPF Programmable Settings

| P0_R107_D[1:0] : HPF_SEL[1:0] | -3-dB CUTOFF FREQUENCY SETTING | -3-dB CUTOFF FREQUENCY AT 16-kHz SAMPLE RATE | -3-dB CUTOFF FREQUENCY AT 48-kHz SAMPLE RATE |
|-------------------------------|-----------------------------------|--|--|
| 00 | Programmable 1st-order IIR filter | Programmable 1st-order IIR filter | Programmable 1st-order IIR filter |
| 01 (default) | $0.00025 \times f_s$ | 4 Hz | 12 Hz |
| 10 | $0.002 \times f_s$ | 32 Hz | 96 Hz |
| 11 | $0.008 \times f_s$ | 128 Hz | 384 Hz |



図 7-17. HPF Filter Frequency Response Plot

式 1 gives the transfer function for the first-order programmable IIR filter:

$$H(z) = \frac{N_0 + N_1 z^{-1}}{2^{31} - D_1 z^{-1}} \quad (1)$$

The frequency response for this first-order programmable IIR filter with default coefficients is flat at a gain of 0 dB (all-pass filter). The host device can override the frequency response by programming the IIR coefficients in [表 7-17](#) to achieve the desired frequency response for high-pass filtering or any other desired filtering. If HPF_SEL[1:0] are set to 2'b00, the host device must write these coefficients values for the desired frequency response before powering-up any ADC channel for recording. These programmable coefficients are 32-bit, two's complement numbers. [表 7-17](#) shows the filter coefficients for the first-order IIR filter.

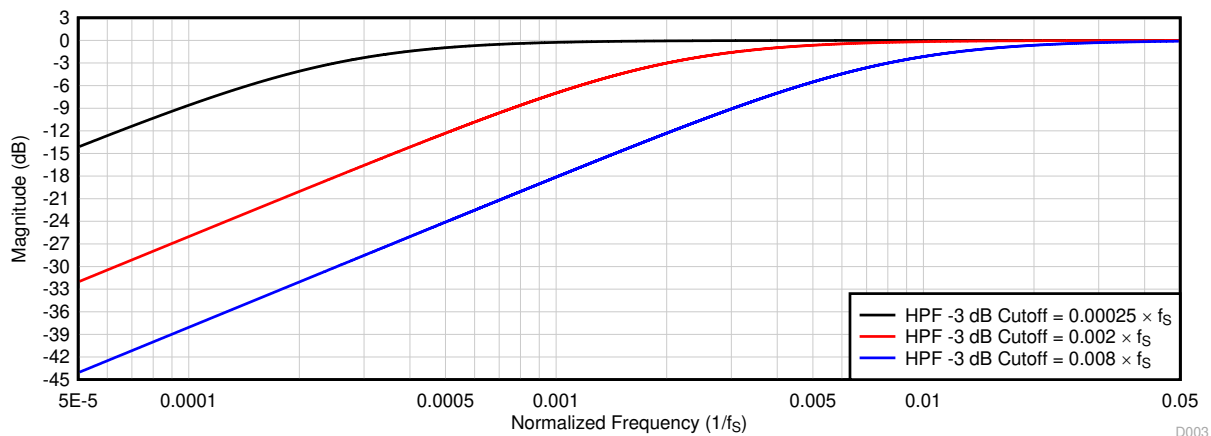
表 7-17. 1st-Order IIR Filter Coefficients

| FILTER | FILTER COEFFICIENT | DEFAULT COEFFICIENT VALUE | COEFFICIENT REGISTER MAPPING |
|---|--------------------|---------------------------|------------------------------|
| Programmable 1st-order IIR filter (can be allocated to HPF or any other desired filter) | N ₀ | 0x7FFFFFFF | P4_R72-R75 |
| | N ₁ | 0x00000000 | P4_R76-R79 |
| | D ₁ | 0x00000000 | P4_R80-R83 |

7.3.6.5 Programmable Digital Biquad Filters

The device supports up to 12 programmable digital biquad filters. These highly efficient filters achieve the desired frequency response. In digital signal processing, a digital biquad filter is a second-order, recursive linear filter with two poles and two zeros. [式 2](#) gives the transfer function of each biquad filter:

$$H(z) = \frac{N_0 + 2N_1 z^{-1} + N_2 z^{-2}}{2^{31} - 2D_1 z^{-1} - D_2 z^{-2}} \quad (2)$$

The frequency response for the biquad filter section with default coefficients is flat at a gain of 0 dB (all-pass filter). The host device can override the frequency response by programming the biquad coefficients to achieve the desired frequency response for a low-pass, high-pass, or any other desired frequency shaping. The programmable coefficients for the mixer operation are located in the [セクション 7.6.2.1](#) and [セクション 7.6.2.2](#) sections. If biquad filtering is required, then the host device must write these coefficients values before powering up any ADC channels for recording. These programmable coefficients are 32-bit, two's complement numbers. As described in [表 7-18](#), these biquad filters can be allocated for each output channel based on the BIQUAD_CFG[1:0] register setting of P0_R108. By setting BIQUAD_CFG[1:0] to 2'b00, the biquad filtering for all record channels is disabled and the host device can choose this setting if no additional filtering is required for the system application. See the [TLV320ADCx140 Programmable Biquad Filter Configuration and Applications application report](#) for further details.

表 7-18. Biquad Filter Allocation to the Record Output Channel

| PROGRAMMABLE BIQUAD FILTER | RECORD OUTPUT CHANNEL ALLOCATION USING P0_R108_D[6:5] REGISTER SETTING | | |
|----------------------------|--|--|--|
| | BIQUAD_CFG[1:0] = 2'b01 (1 Biquad per Channel) | BIQUAD_CFG[1:0] = 2'b10 (Default) (2 Biquads per Channel) | BIQUAD_CFG[1:0] = 2'b11 (3 Biquads per Channel) |
| | SUPPORTS ALL 8 CHANNELS | SUPPORTS UP TO 6 CHANNELS | SUPPORTS UP TO 4 CHANNELS |
| Biquad filter 1 | Allocated to output channel 1 | Allocated to output channel 1 | Allocated to output channel 1 |
| Biquad filter 2 | Allocated to output channel 2 | Allocated to output channel 2 | Allocated to output channel 2 |
| Biquad filter 3 | Allocated to output channel 3 | Allocated to output channel 3 | Allocated to output channel 3 |
| Biquad filter 4 | Allocated to output channel 4 | Allocated to output channel 4 | Allocated to output channel 4 |
| Biquad filter 5 | Not used | Allocated to output channel 1 | Allocated to output channel 1 |
| Biquad filter 6 | Not used | Allocated to output channel 2 | Allocated to output channel 2 |
| Biquad filter 7 | Not used | Allocated to output channel 3 | Allocated to output channel 3 |
| Biquad filter 8 | Not used | Allocated to output channel 4 | Allocated to output channel 4 |

表 7-18. Biquad Filter Allocation to the Record Output Channel (続き)

| PROGRAMMABLE BIQUAD FILTER | RECORD OUTPUT CHANNEL ALLOCATION USING P0_R108_D[6:5] REGISTER SETTING | | |
|----------------------------|--|--|--|
| | BIQUAD_CFG[1:0] = 2'b01 (1 Biquad per Channel) | BIQUAD_CFG[1:0] = 2'b10 (Default) (2 Biquads per Channel) | BIQUAD_CFG[1:0] = 2'b11 (3 Biquads per Channel) |
| | SUPPORTS ALL 8 CHANNELS | SUPPORTS UP TO 6 CHANNELS | SUPPORTS UP TO 4 CHANNELS |
| Biquad filter 9 | Allocated to output channel 5 | Allocated to output channel 5 | Allocated to output channel 1 |
| Biquad filter 10 | Allocated to output channel 6 | Allocated to output channel 6 | Allocated to output channel 2 |
| Biquad filter 11 | Allocated to output channel 7 | Allocated to output channel 5 | Allocated to output channel 3 |
| Biquad filter 12 | Allocated to output channel 8 | Allocated to output channel 6 | Allocated to output channel 4 |

表 7-19 shows the biquad filter coefficients mapping to the register space.

表 7-19. Biquad Filter Coefficients Register Mapping

| PROGRAMMABLE BIQUAD FILTER | BIQUAD FILTER COEFFICIENTS REGISTER MAPPING | PROGRAMMABLE BIQUAD FILTER | BIQUAD FILTER COEFFICIENTS REGISTER MAPPING |
|----------------------------|---|----------------------------|---|
| Biquad filter 1 | P2_R8-R27 | Biquad filter 7 | P3_R8-R27 |
| Biquad filter 2 | P2_R28-R47 | Biquad filter 8 | P3_R28-R47 |
| Biquad filter 3 | P2_R48-R67 | Biquad filter 9 | P3_R48-R67 |
| Biquad filter 4 | P2_R68-R87 | Biquad filter 10 | P3_R68-R87 |
| Biquad filter 5 | P2_R88-R107 | Biquad filter 11 | P3_R88-R107 |
| Biquad filter 6 | P2_R108-R127 | Biquad filter 12 | P3_R108-R127 |

7.3.6.6 Programmable Channel Summer and Digital Mixer

For applications that require an even higher SNR than that supported for each channel, the device's digital summing mode can be used. In this mode, the digital record data are summed up across the channel with an equal weightage factor, which helps in reducing the effective record noise. 表 7-20 lists the configuration settings available for channel summing mode.

表 7-20. Channel Summing Mode Programmable Settings

| P0_R107_D[3:2] : CH_SUM[1:0] | CHANNEL SUMMING MODE FOR INPUT CHANNELS | SNR AND DYNAMIC RANGE BOOST |
|------------------------------|--|--|
| 00 (Default) | Channel summing mode is disabled | Not applicable |
| 01 | Output channel 1 = (input channel 1 + input channel 2) / 2 | Around 3-dB boost in SNR and dynamic range |
| | Output channel 2 = (input channel 1 + input channel 2) / 2 | |
| | Output channel 3 = (input channel 3 + input channel 4) / 2 | |
| | Output channel 4 = (input channel 3 + input channel 4) / 2 | |
| | Output channel 5 = (input channel 5 + input channel 6) / 2 | |
| | Output channel 6 = (input channel 5 + input channel 6) / 2 | |
| 10 | Output channel 1 = (input channel 1 + input channel 2 + input channel 3 + input channel 4) / 4 | Around 6-dB boost in SNR and dynamic range |
| | Output channel 2 = (input channel 1 + input channel 2 + input channel 3 + input channel 4) / 4 | |
| | Output channel 3 = (input channel 1 + input channel 2 + input channel 3 + input channel 4) / 4 | |
| | Output channel 4 = (input channel 1 + input channel 2 + input channel 3 + input channel 4) / 4 | |
| 11 | Reserved (do not use this setting) | Not applicable |

The device additionally supports a fully programmable mixer feature that can mix the various input channels with their custom programmable scale factor to generate the final output channels. The programmable mixer feature

is available only if CH_SUM[1:0] is set to 2'b00. The mixer function is only supported for input channel 1 to channel 4.  7-18 shows a block diagram that describes the mixer 1 operation to generate output channel 1. The programmable coefficients for the mixer operation are located in the [セクション 7.6.2.3](#) section.

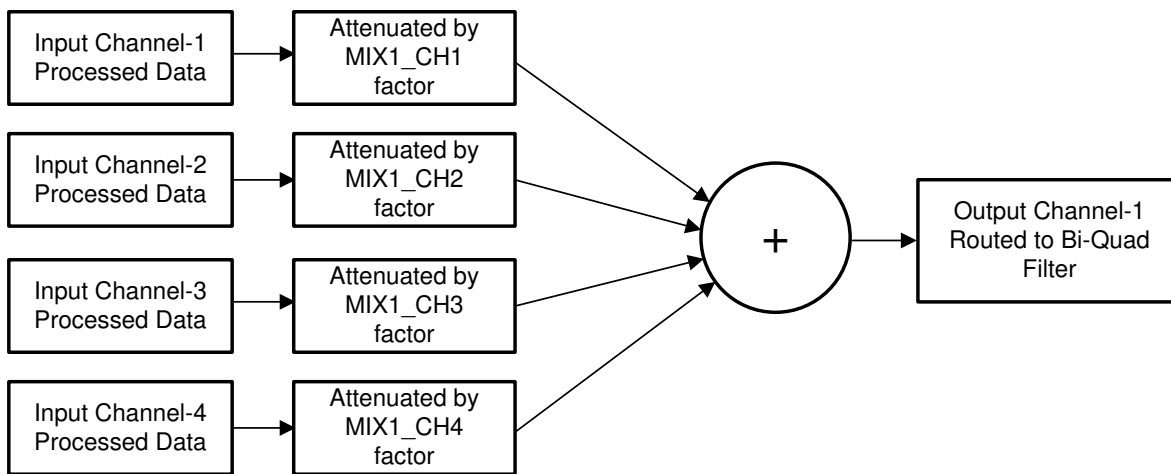

 7-18. Programmable Digital Mixer Block Diagram

A similar mixer operation is performed by mixer 2, mixer 3, and mixer 4 to generate output channel 2, channel 3, and channel 4, respectively.

7.3.6.7 Configurable Digital Decimation Filters

The device record channel includes a high dynamic range, built-in digital decimation filter to process the oversampled data from the multibit delta-sigma ($\Delta\Sigma$) modulator to generate digital data at the same Nyquist sampling rate as the FSYNC rate. As illustrated in [図 7-16](#), this decimation filter can also be used for processing the oversampled PDM stream from the digital microphone. The decimation filter can be chosen from three different types, depending on the required frequency response, group delay, and phase linearity requirements for the target application. The selection of the decimation filter option can be done by configuring the DECI_FILTER, P0_R107_D[5:4] register bits. [表 7-21](#) shows the configuration register setting for the decimation filter mode selection for the record channel.

表 7-21. Decimation Filter Mode Selection for the Record Channel

| P0_R107_D[5:4] : DECI_FILTER[1:0] | DECIMATION FILTER MODE SELECTION |
|-----------------------------------|---|
| 00 (default) | Linear phase filters are used for the decimation |
| 01 | Low latency filters are used for the decimation |
| 10 | Ultra-low latency filters are used for the decimation |
| 11 | Reserved (do not use this setting) |

7.3.6.7.1 Linear Phase Filters

The linear phase decimation filters are the default filters set by the device and can be used for all applications that require a perfect linear phase with zero-phase deviation within the pass-band specification of the filter. The filter performance specifications and various plots for all supported output sampling rates are listed in this section.

7.3.6.7.1.1 Sampling Rate: 8 kHz or 7.35 kHz

[図 7-19](#) and [図 7-20](#) respectively show the magnitude response and the pass-band ripple for a decimation filter with a sampling rate of 8 kHz or 7.35 kHz. [表 7-22](#) lists the specifications for a decimation filter with an 8-kHz or 7.35-kHz sampling rate.



表 7-22. Linear Phase Decimation Filter Specifications

| PARAMETER | TEST CONDITIONS | MIN | TYP | MAX | UNIT |
|------------------------|--|-------|------|------|---------|
| Pass-band ripple | Frequency range is 0 to $0.454 \times f_s$ | -0.05 | | 0.05 | dB |
| Stop-band attenuation | Frequency range is $0.58 \times f_s$ to $4 \times f_s$ | 72.7 | | | dB |
| | Frequency range is $4 \times f_s$ onwards | 81.2 | | | |
| Group delay or latency | Frequency range is 0 to $0.454 \times f_s$ | | 17.1 | | $1/f_s$ |

7.3.6.7.1.2 Sampling Rate: 16 kHz or 14.7 kHz

Figure 7-21 and Figure 7-22 respectively show the magnitude response and the pass-band ripple for a decimation filter with a sampling rate of 16 kHz or 14.7 kHz. Table 7-23 lists the specifications for a decimation filter with an 16-kHz or 14.7-kHz sampling rate.

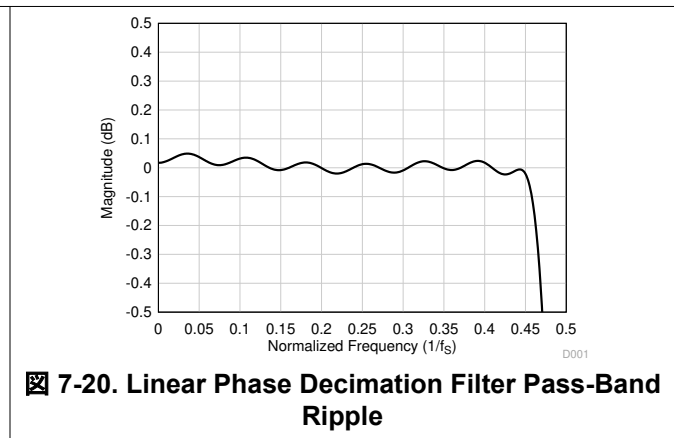
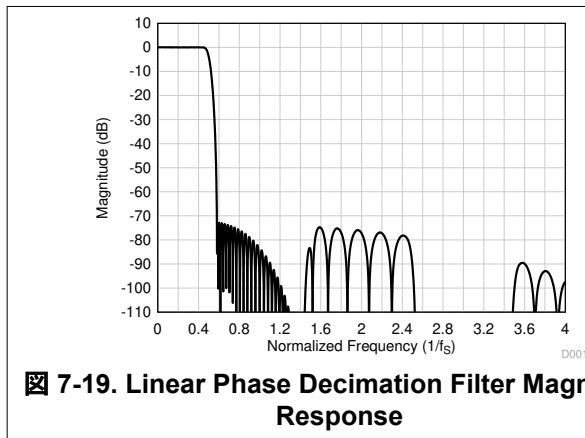

表 7-23. Linear Phase Decimation Filter Specifications

| PARAMETER | TEST CONDITIONS | MIN | TYP | MAX | UNIT |
|------------------------|--|-------|------|------|---------|
| Pass-band ripple | Frequency range is 0 to $0.454 \times f_s$ | -0.05 | | 0.05 | dB |
| Stop-band attenuation | Frequency range is $0.58 \times f_s$ to $4 \times f_s$ | 73.3 | | | dB |
| | Frequency range is $4 \times f_s$ onwards | 95.0 | | | |
| Group delay or latency | Frequency range is 0 to $0.454 \times f_s$ | | 15.7 | | $1/f_s$ |

7.3.6.7.1.3 Sampling Rate: 24 kHz or 22.05 kHz

Figure 7-23 and Figure 7-24 respectively show the magnitude response and the pass-band ripple for a decimation filter with a sampling rate of 24 kHz or 22.05 kHz. Table 7-24 lists the specifications for a decimation filter with an 24-kHz or 22.05-kHz sampling rate.

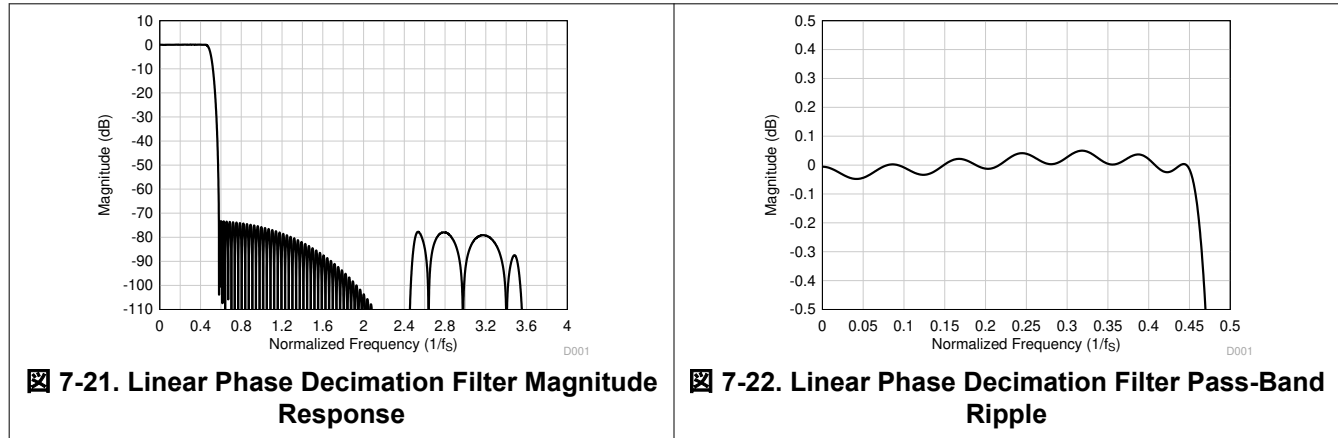

表 7-24. Linear Phase Decimation Filter Specifications

| PARAMETER | TEST CONDITIONS | MIN | TYP | MAX | UNIT |
|-----------------------|--|-------|-----|------|------|
| Pass-band ripple | Frequency range is 0 to $0.454 \times f_s$ | -0.05 | | 0.05 | dB |
| Stop-band attenuation | Frequency range is $0.58 \times f_s$ to $4 \times f_s$ | 73.0 | | | dB |
| | Frequency range is $4 \times f_s$ onwards | 96.4 | | | |

表 7-24. Linear Phase Decimation Filter Specifications (続き)

| PARAMETER | TEST CONDITIONS | MIN | TYP | MAX | UNIT |
|------------------------|--|-----|------|-----|---------|
| Group delay or latency | Frequency range is 0 to $0.454 \times f_S$ | | 16.6 | | $1/f_S$ |

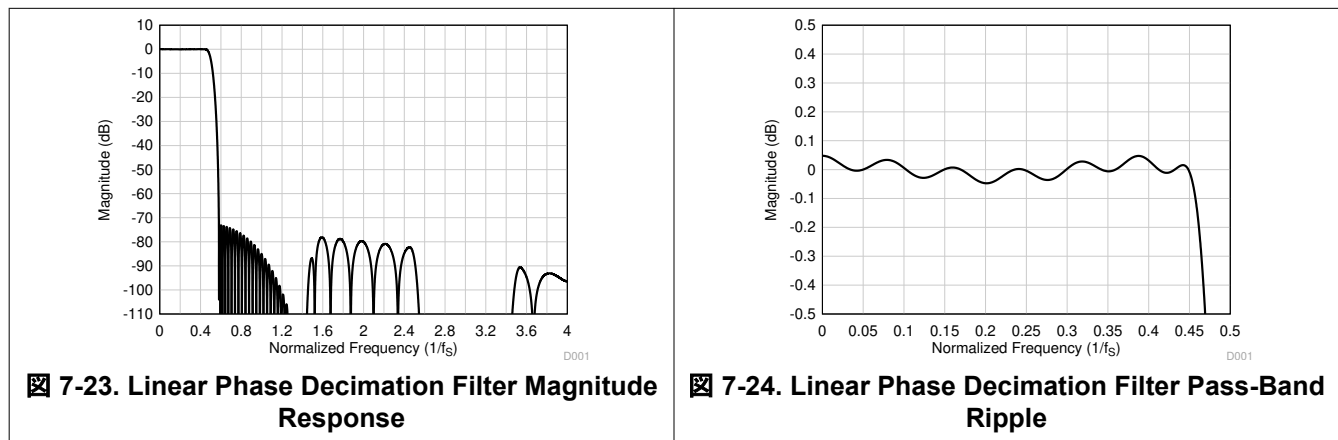
7.3.6.7.1.4 Sampling Rate: 32 kHz or 29.4 kHz

図 7-25 and 図 7-26 respectively show the magnitude response and the pass-band ripple for a decimation filter with a sampling rate of 32 kHz or 29.4 kHz. 表 7-25 lists the specifications for a decimation filter with an 32-kHz or 29.4-kHz sampling rate.



図 7-25. Linear Phase Decimation Filter Magnitude Response



図 7-26. Linear Phase Decimation Filter Pass-Band Ripple

表 7-25. Linear Phase Decimation Filter Specifications

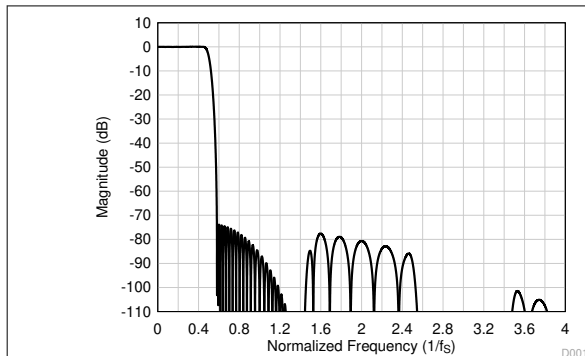
| PARAMETER | TEST CONDITIONS | MIN | TYP | MAX | UNIT |
|------------------------|--|-------|------|------|---------|
| Pass-band ripple | Frequency range is 0 to $0.454 \times f_S$ | -0.05 | | 0.05 | dB |
| Stop-band attenuation | Frequency range is $0.58 \times f_S$ to $4 \times f_S$ | 73.7 | | | dB |
| | Frequency range is $4 \times f_S$ onwards | 107.2 | | | |
| Group delay or latency | Frequency range is 0 to $0.454 \times f_S$ | | 16.9 | | $1/f_S$ |

7.3.6.7.1.5 Sampling Rate: 48 kHz or 44.1 kHz

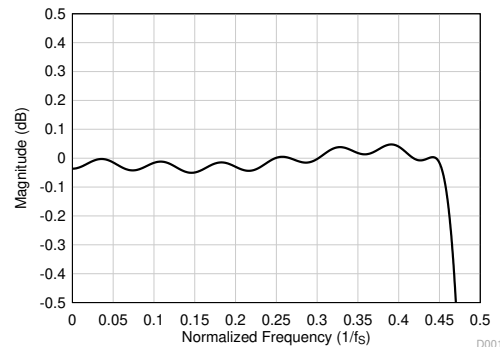
図 7-27 and 図 7-28 respectively show the magnitude response and the pass-band ripple for a decimation filter with a sampling rate of 48 kHz or 44.1 kHz. 表 7-26 lists the specifications for a decimation filter with an 48-kHz or 44.1-kHz sampling rate.



図 7-27. Linear Phase Decimation Filter Magnitude Response



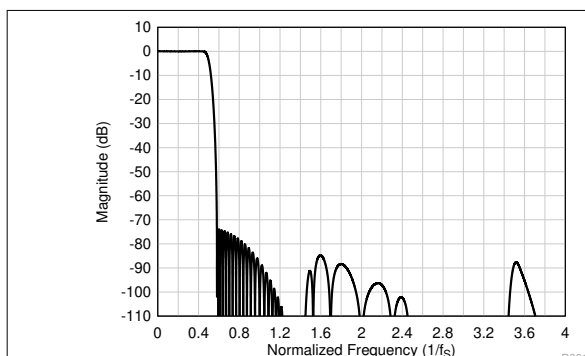

図 7-28. Linear Phase Decimation Filter Pass-Band Ripple

表 7-26. Linear Phase Decimation Filter Specifications

| PARAMETER | TEST CONDITIONS | MIN | TYP | MAX | UNIT |
|------------------------|--|-------|------|------|---------|
| Pass-band ripple | Frequency range is 0 to $0.454 \times f_S$ | -0.05 | | 0.05 | dB |
| Stop-band attenuation | Frequency range is $0.58 \times f_S$ to $4 \times f_S$ | 73.8 | | | dB |
| | Frequency range is $4 \times f_S$ onwards | 98.1 | | | |
| Group delay or latency | Frequency range is 0 to $0.454 \times f_S$ | | 17.1 | | $1/f_S$ |

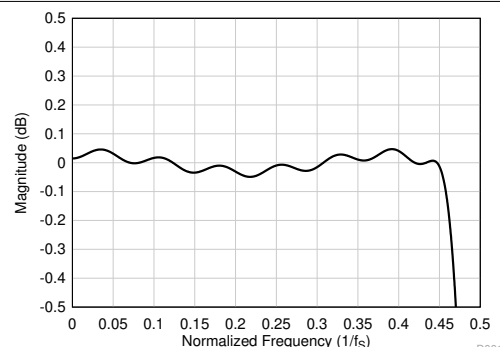
7.3.6.7.1.6 Sampling Rate: 96 kHz or 88.2 kHz

 7-29 and  7-30 respectively show the magnitude response and the pass-band ripple for a decimation filter with a sampling rate of 96 kHz or 88.2 kHz. 表 7-27 lists the specifications for a decimation filter with an 96-kHz or 88.2-kHz sampling rate.





表 7-27. Linear Phase Decimation Filter Specifications

| PARAMETER | TEST CONDITIONS | MIN | TYP | MAX | UNIT |
|------------------------|--|-------|------|------|---------|
| Pass-band ripple | Frequency range is 0 to $0.454 \times f_S$ | -0.05 | | 0.05 | dB |
| Stop-band attenuation | Frequency range is $0.58 \times f_S$ to $4 \times f_S$ | 73.6 | | | dB |
| | Frequency range is $4 \times f_S$ onwards | 97.9 | | | |
| Group delay or latency | Frequency range is 0 to $0.454 \times f_S$ | | 17.1 | | $1/f_S$ |

7.3.6.7.1.7 Sampling Rate: 192 kHz or 176.4 kHz

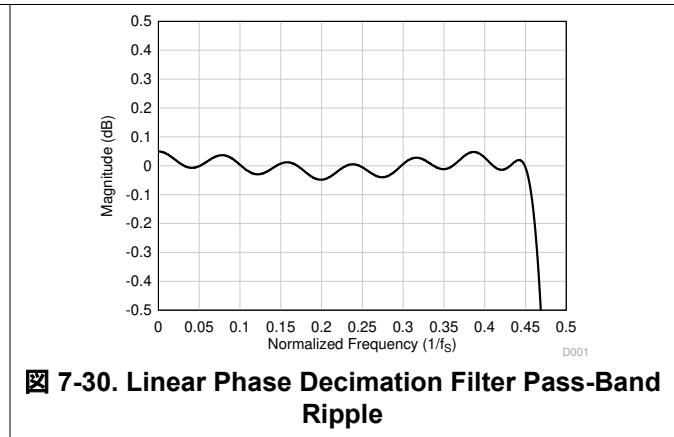
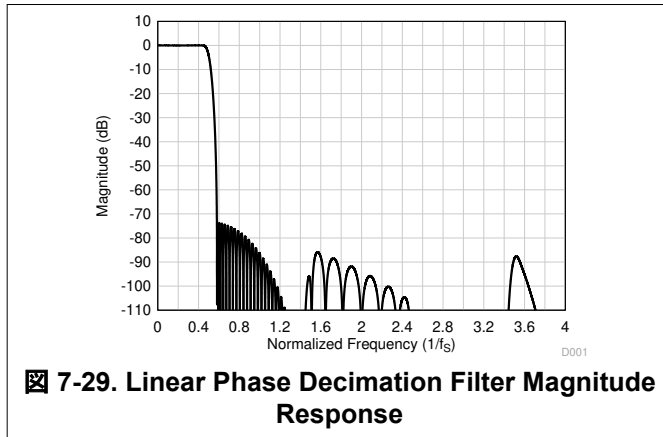
 7-31 and  7-32 respectively show the magnitude response and the pass-band ripple for a decimation filter with a sampling rate of 192 kHz or 176.4 kHz. 表 7-28 lists the specifications for a decimation filter with an 192-kHz or 176.4-kHz sampling rate.



図 7-31. Linear Phase Decimation Filter Magnitude Response



図 7-32. Linear Phase Decimation Filter Pass-Band Ripple

表 7-28. Linear Phase Decimation Filter Specifications

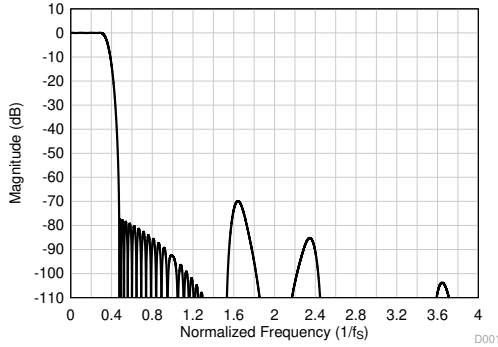
| PARAMETER | TEST CONDITIONS | MIN | TYP | MAX | UNIT |
|------------------------|---|-------|------|------|------|
| Pass-band ripple | Frequency range is 0 to $0.3 \times f_s$ | -0.05 | | 0.05 | dB |
| Stop-band attenuation | Frequency range is $0.473 \times f_s$ to $4 \times f_s$ | 70.0 | | | |
| | Frequency range is $4 \times f_s$ onwards | 111.0 | | | dB |
| Group delay or latency | Frequency range is 0 to $0.3 \times f_s$ | | 11.9 | | |

7.3.6.7.1.8 Sampling Rate: 384 kHz or 352.8 kHz

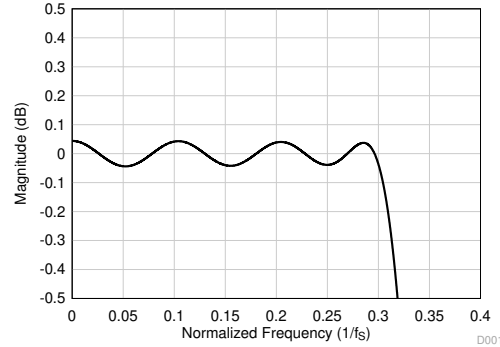
図 7-33 and 図 7-34 respectively show the magnitude response and the pass-band ripple for a decimation filter with a sampling rate of 384 kHz or 352.8 kHz. 表 7-29 lists the specifications for a decimation filter with an 384-kHz or 352.8-kHz sampling rate.



図 7-33. Linear Phase Decimation Filter Magnitude Response



図 7-34. Linear Phase Decimation Filter Pass-Band Ripple

表 7-29. Linear Phase Decimation Filter Specifications

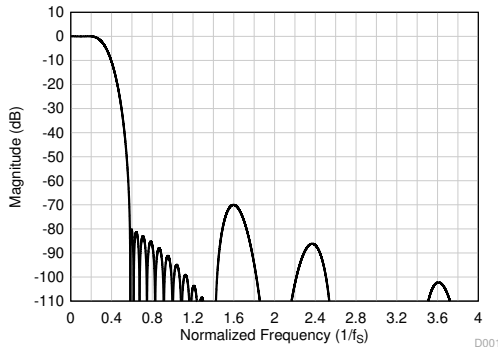
| PARAMETER | TEST CONDITIONS | MIN | TYP | MAX | UNIT |
|------------------------|--|-------|-----|------|------|
| Pass-band ripple | Frequency range is 0 to $0.212 \times f_s$ | -0.05 | | 0.05 | dB |
| Stop-band attenuation | Frequency range is $0.58 \times f_s$ to $4 \times f_s$ | 70.0 | | | |
| | Frequency range is $4 \times f_s$ onwards | 108.8 | | | dB |
| Group delay or latency | Frequency range is 0 to $0.212 \times f_s$ | | 7.2 | | |

7.3.6.7.1.9 Sampling Rate 768 kHz or 705.6 kHz

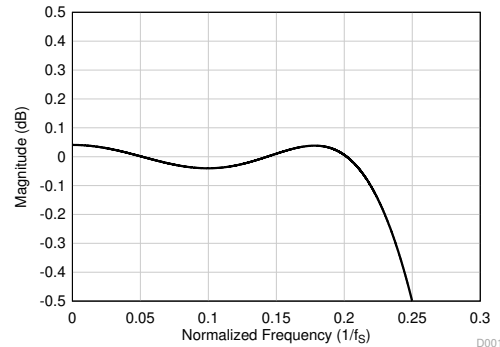
☒ 7-35 and ☒ 7-36 respectively show the magnitude response and the pass-band ripple for a decimation filter with a sampling rate of 768 kHz or 705.6 kHz. 表 7-30 lists the specifications for a decimation filter with an 768-kHz or 705.6-kHz sampling rate.



表 7-30. Linear Phase Decimation Filter Specifications

| PARAMETER | TEST CONDITIONS | MIN | TYP | MAX | UNIT |
|------------------------|--|-------|-----|------|---------|
| Pass-band ripple | Frequency range is 0 to $0.113 \times f_s$ | -0.05 | | 0.05 | dB |
| Stop-band attenuation | Frequency range is $0.58 \times f_s$ to $2 \times f_s$ | 75.0 | | | dB |
| | Frequency range is $2 \times f_s$ onwards | 88.0 | | | |
| Group Delay or Latency | Frequency range is 0 to $0.113 \times f_s$ | | 5.9 | | $1/f_s$ |

7.3.6.7.2 Low-Latency Filters

For applications where low latency with minimal phase deviation (within the audio band) is critical, the low-latency decimation filters on the PCM5140-Q1 can be used. The device supports these filters with a group delay of approximately seven samples with an almost linear phase response within the $0.365 \times f_s$ frequency band. This section provides the filter performance specifications and various plots for all supported output sampling rates for the low-latency filters.

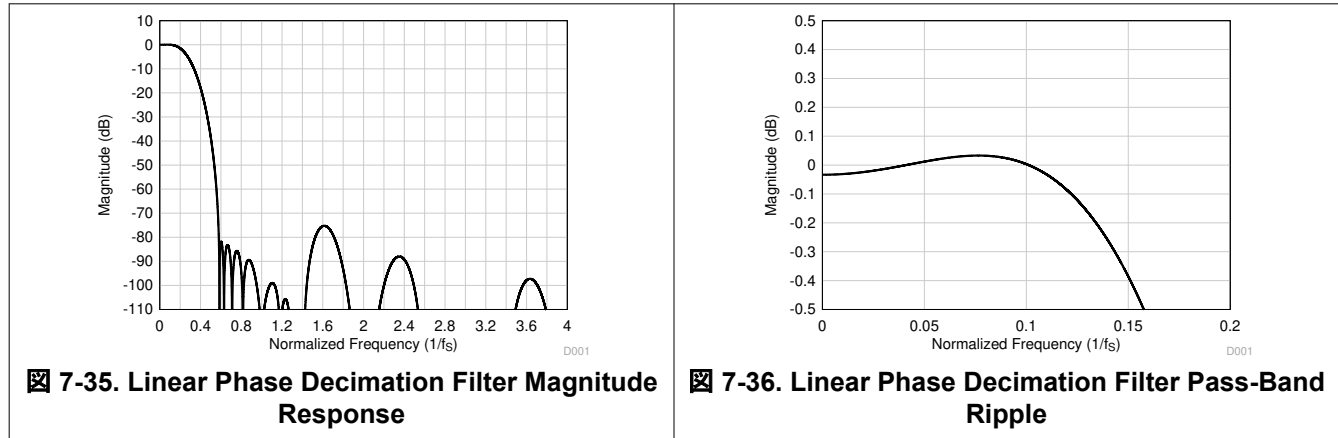
7.3.6.7.2.1 Sampling Rate: 16 kHz or 14.7 kHz

Figure 7-37 shows the magnitude response and Figure 7-38 shows the pass-band ripple and phase deviation for a decimation filter with a sampling rate of 16 kHz or 14.7 kHz. Table 7-31 lists the specifications for a decimation filter with a 16-kHz or 14.7-kHz sampling rate.



表 7-31. Low-Latency Decimation Filter Specifications

| PARAMETER | TEST CONDITIONS | MIN | TYP | MAX | UNIT |
|------------------------|--|--------|-----|-------|---------|
| Pass-band ripple | Frequency range is 0 to $0.451 \times f_s$ | -0.05 | | 0.05 | dB |
| Stop-band attenuation | Frequency range is $0.61 \times f_s$ onwards | 87.3 | | | dB |
| Group delay or latency | Frequency range is 0 to $0.363 \times f_s$ | | 7.6 | | $1/f_s$ |
| Group delay deviation | Frequency range is 0 to $0.363 \times f_s$ | -0.022 | | 0.022 | $1/f_s$ |
| Phase deviation | Frequency range is 0 to $0.363 \times f_s$ | -0.21 | | 0.25 | Degrees |

7.3.6.7.2.2 Sampling Rate: 24 kHz or 22.05 kHz

☒ 7-39 shows the magnitude response and ☒ 7-40 shows the pass-band ripple and phase deviation for a decimation filter with a sampling rate of 24 kHz or 22.05 kHz. 表 7-32 lists the specifications for a decimation filter with a 24-kHz or 22.05-kHz sampling rate.

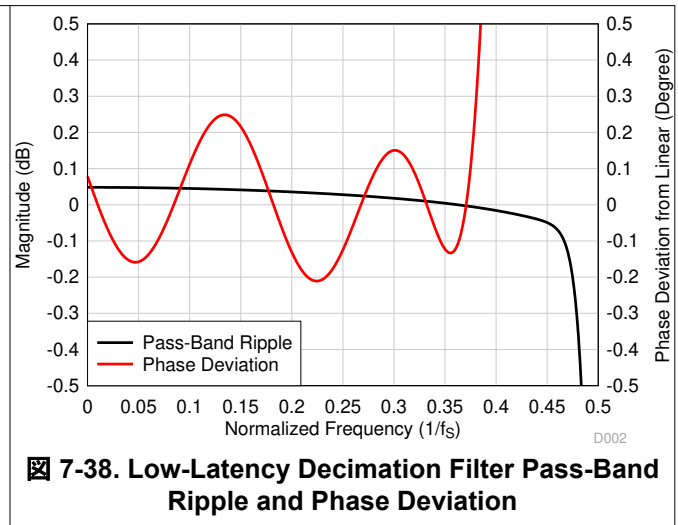
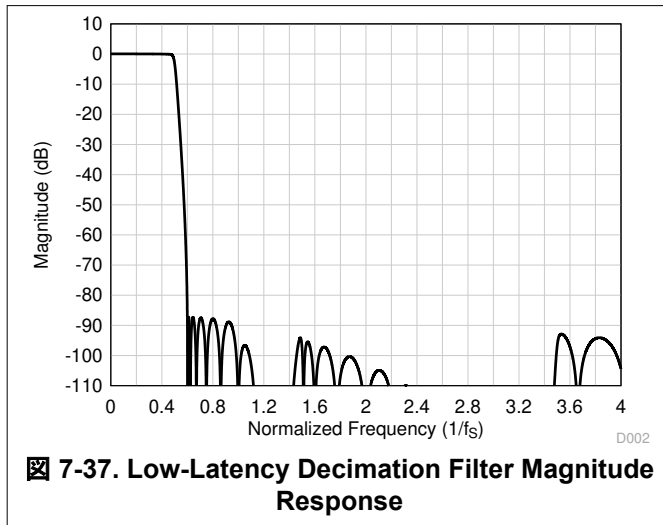

表 7-32. Low-Latency Decimation Filter Specifications

| PARAMETER | TEST CONDITIONS | MIN | TYP | MAX | UNIT |
|------------------------|---|--------|-----|-------|---------|
| Pass-band ripple | Frequency range is 0 to $0.459 \times f_s$ | -0.01 | | 0.01 | dB |
| Stop-band attenuation | Frequency range is $0.6 \times f_s$ onwards | 87.2 | | | dB |
| Group delay or latency | Frequency range is 0 to $0.365 \times f_s$ | | 7.5 | | $1/f_s$ |
| Group delay deviation | Frequency range is 0 to $0.365 \times f_s$ | -0.026 | | 0.026 | $1/f_s$ |
| Phase deviation | Frequency range is 0 to $0.365 \times f_s$ | -0.26 | | 0.30 | Degrees |

7.3.6.7.2.3 Sampling Rate: 32 kHz or 29.4 kHz

☒ 7-41 shows the magnitude response and ☒ 7-42 shows the pass-band ripple and phase deviation for a decimation filter with a sampling rate of 32 kHz or 29.4 kHz. 表 7-33 lists the specifications for a decimation filter with a 32-kHz or 29.4-kHz sampling rate.

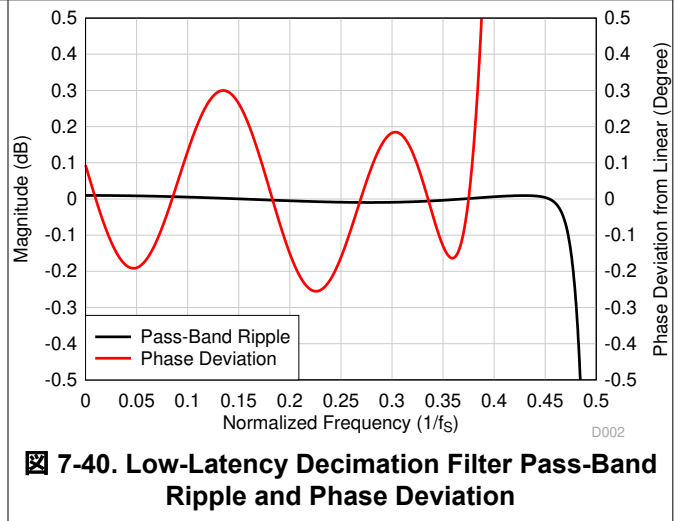
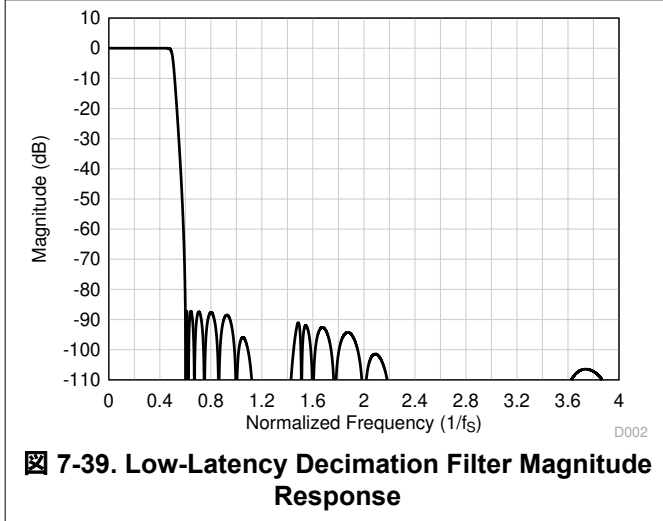

表 7-33. Low-Latency Decimation Filter Specifications

| PARAMETER | TEST CONDITIONS | MIN | TYP | MAX | UNIT |
|------------------------|---|--------|-----|-------|---------|
| Pass-band ripple | Frequency range is 0 to $0.457 \times f_S$ | -0.04 | | 0.04 | dB |
| Stop-band attenuation | Frequency range is $0.6 \times f_S$ onwards | 88.3 | | | dB |
| Group delay or latency | Frequency range is 0 to $0.368 \times f_S$ | | 8.7 | | $1/f_S$ |
| Group delay deviation | Frequency range is 0 to $0.368 \times f_S$ | -0.026 | | 0.026 | $1/f_S$ |
| Phase deviation | Frequency range is 0 to $0.368 \times f_S$ | -0.26 | | 0.31 | Degrees |

7.3.6.7.2.4 Sampling Rate: 48 kHz or 44.1 kHz

図 7-43 shows the magnitude response and 図 7-44 shows the pass-band ripple and phase deviation for a decimation filter with a sampling rate of 48 kHz or 44.1 kHz. 表 7-34 lists the specifications for a decimation filter with a 48-kHz or 44.1-kHz sampling rate.

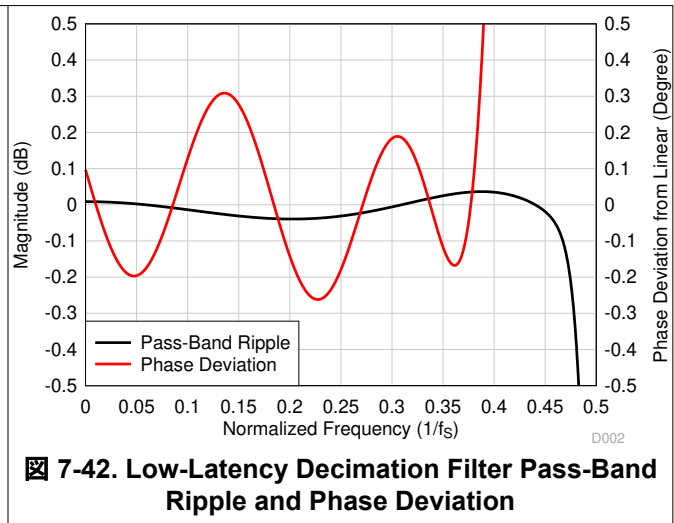
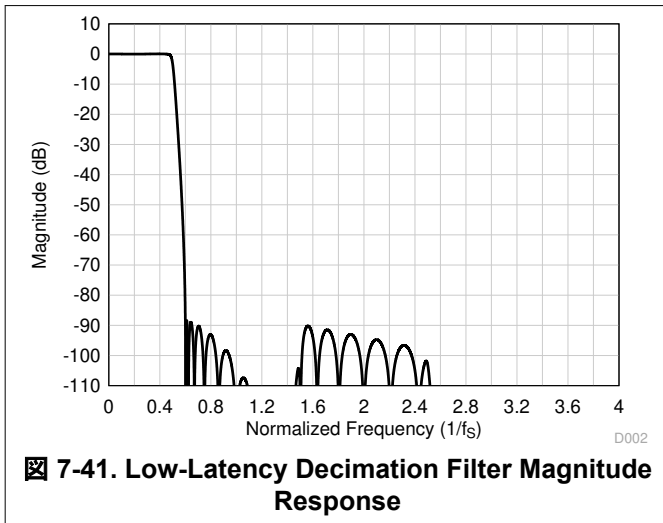

表 7-34. Low-Latency Decimation Filter Specifications

| PARAMETER | TEST CONDITIONS | MIN | TYP | MAX | UNIT |
|------------------------|---|--------|-----|-------|---------|
| Pass-band ripple | Frequency range is 0 to $0.452 \times f_S$ | -0.015 | | 0.015 | dB |
| Stop-band attenuation | Frequency range is $0.6 \times f_S$ onwards | 86.4 | | | dB |
| Group delay or latency | Frequency range is 0 to $0.365 \times f_S$ | | 7.7 | | $1/f_S$ |
| Group delay deviation | Frequency range is 0 to $0.365 \times f_S$ | -0.027 | | 0.027 | $1/f_S$ |
| Phase deviation | Frequency range is 0 to $0.365 \times f_S$ | -0.25 | | 0.30 | Degrees |

7.3.6.7.2.5 Sampling Rate: 96 kHz or 88.2 kHz

☒ 7-45 shows the magnitude response and ☒ 7-46 shows the pass-band ripple and phase deviation for a decimation filter with a sampling rate of 96 kHz or 88.2 kHz. 表 7-35 lists the specifications for a decimation filter with a 96-kHz or 88.2-kHz sampling rate.

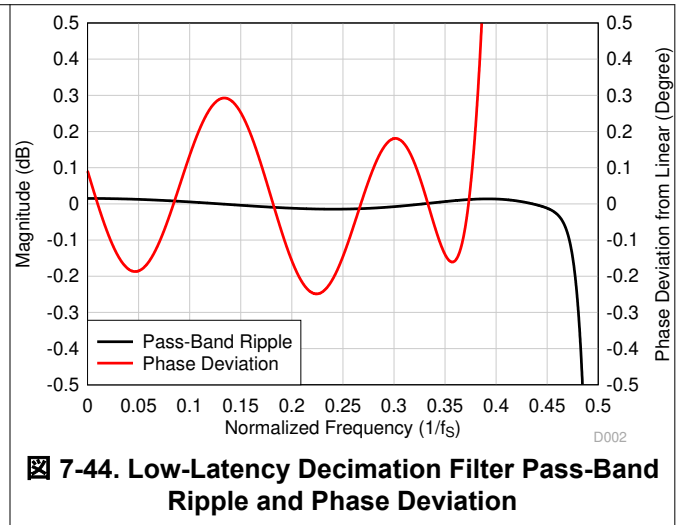
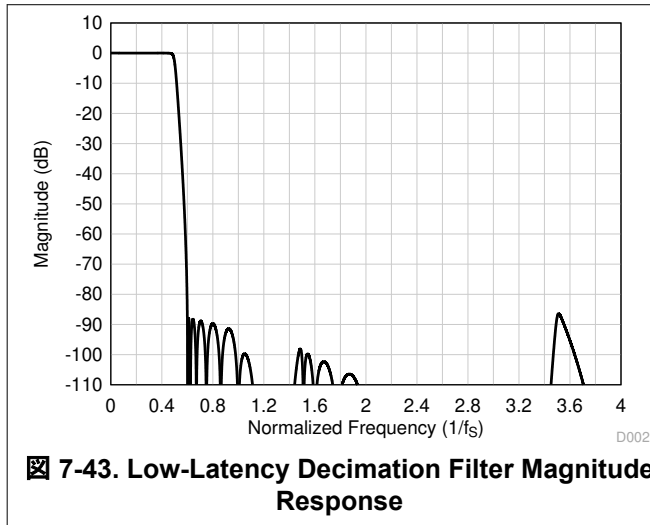

表 7-35. Low-Latency Decimation Filter Specifications

| PARAMETER | TEST CONDITIONS | MIN | TYP | MAX | UNIT |
|------------------------|---|--------|-----|-------|---------|
| Pass-band ripple | Frequency range is 0 to $0.466 \times f_s$ | -0.04 | | 0.04 | dB |
| Stop-band attenuation | Frequency range is $0.6 \times f_s$ onwards | 86.3 | | | dB |
| Group delay or latency | Frequency range is 0 to $0.365 \times f_s$ | | 7.7 | | $1/f_s$ |
| Group delay deviation | Frequency range is 0 to $0.365 \times f_s$ | -0.027 | | 0.027 | $1/f_s$ |
| Phase deviation | Frequency range is 0 to $0.365 \times f_s$ | -0.26 | | 0.30 | Degrees |

7.3.6.7.2.6 Sampling Rate 192 kHz or 176.4 kHz

☒ 7-47 shows the magnitude response and ☒ 7-48 shows the pass-band ripple and phase deviation for a decimation filter with a sampling rate of 192 kHz or 176.4 kHz. 表 7-36 lists the specifications for a decimation filter with a 192-kHz or 176.4-kHz sampling rate.

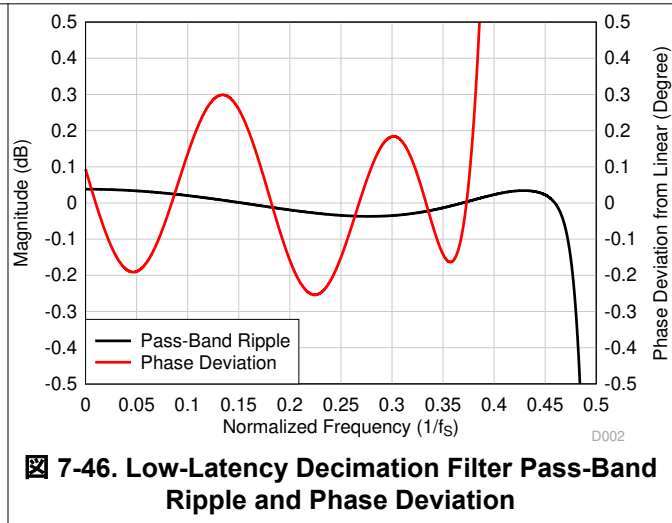
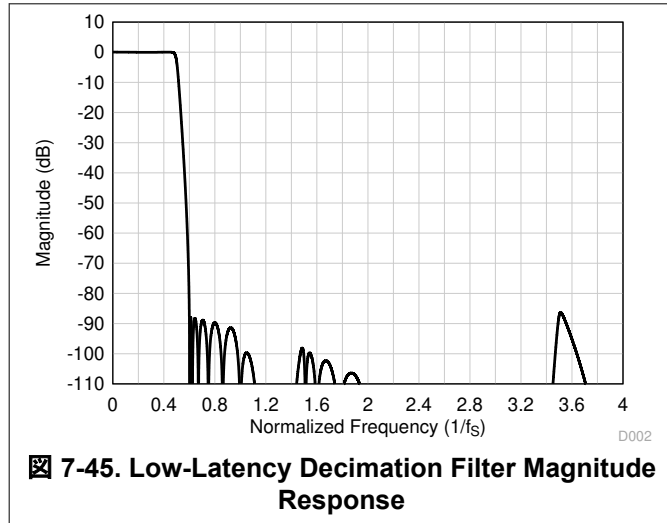

表 7-36. Low-Latency Decimation Filter Specifications

| PARAMETER | TEST CONDITIONS | MIN | TYP | MAX | UNIT |
|------------------------|---|--------|-----|-------|---------|
| Pass-band ripple | Frequency range is 0 to $463 \times f_S$ | -0.03 | | 0.03 | dB |
| Stop-band attenuation | Frequency range is $0.6 \times f_S$ onwards | 85.6 | | | dB |
| Group delay or latency | Frequency range is 0 to $0.365 \times f_S$ | | 7.7 | | $1/f_S$ |
| Group delay deviation | Frequency range is 0 to $0.365 \times f_S$ | -0.027 | | 0.027 | $1/f_S$ |
| Phase deviation | Frequency range is 0 to $0.365 \times f_S$ | -0.26 | | 0.30 | Degrees |

7.3.6.7.3 Ultra-Low-Latency Filters

For applications where ultra-low latency (within the audio band) is critical, the ultra-low-latency decimation filters on the PCM5140-Q1 can be used. The device supports these filters with a group delay of approximately four samples with an almost linear phase response within the $0.325 \times f_S$ frequency band. This section provides the filter performance specifications and various plots for all supported output sampling rates for the ultra-low-latency filters.

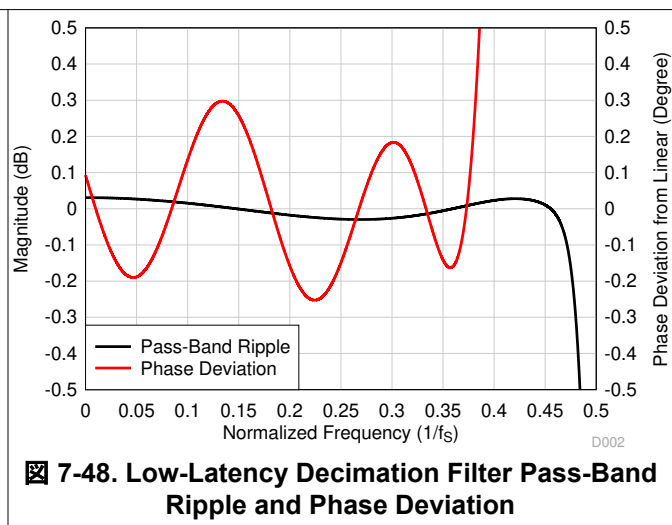
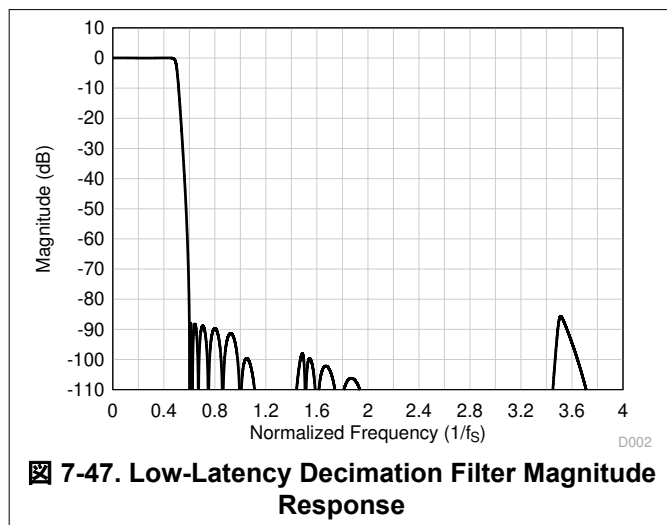
7.3.6.7.3.1 Sampling Rate: 16 kHz or 14.7 kHz

図 7-49 shows the magnitude response and 図 7-50 shows the pass-band ripple and phase deviation for a decimation filter with a sampling rate of 16 kHz or 14.7 kHz. 表 7-37 lists the specifications for a decimation filter with a 16-kHz or 14.7-kHz sampling rate.



表 7-37. Ultra-Low-Latency Decimation Filter Specifications

| PARAMETER | TEST CONDITIONS | MIN | TYP | MAX | UNIT |
|------------------------|---|--------|-----|-------|---------|
| Pass-band ripple | Frequency range is 0 to $0.45 \times f_S$ | -0.05 | | 0.05 | dB |
| Stop-band attenuation | Frequency range is $0.6 \times f_S$ onwards | 87.2 | | | dB |
| Group delay or latency | Frequency range is 0 to $0.325 \times f_S$ | | 4.3 | | $1/f_S$ |
| Group delay deviation | Frequency range is 0 to $0.325 \times f_S$ | -0.512 | | 0.512 | $1/f_S$ |
| Phase deviation | Frequency range is 0 to $0.325 \times f_S$ | -10.0 | | 14.2 | Degrees |

7.3.6.7.3.2 Sampling Rate: 24 kHz or 22.05 kHz

☒ 7-51 shows the magnitude response and ☒ 7-52 shows the pass-band ripple and phase deviation for a decimation filter with a sampling rate of 24 kHz or 22.05 kHz. 表 7-38 lists the specifications for a decimation filter with a 24-kHz or 22.05-kHz sampling rate.

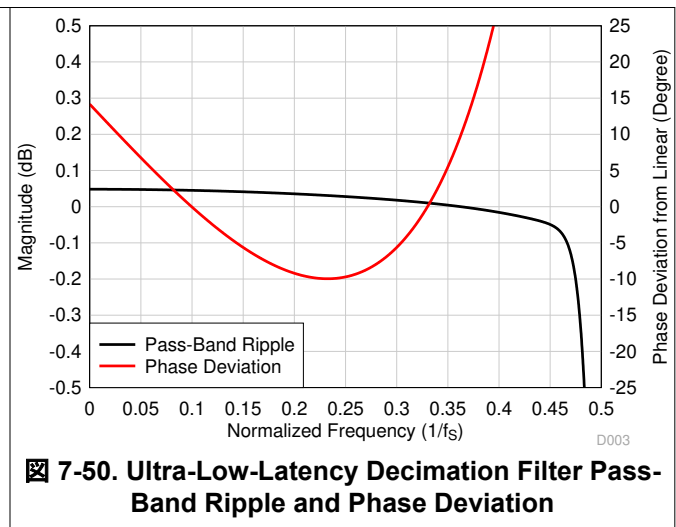
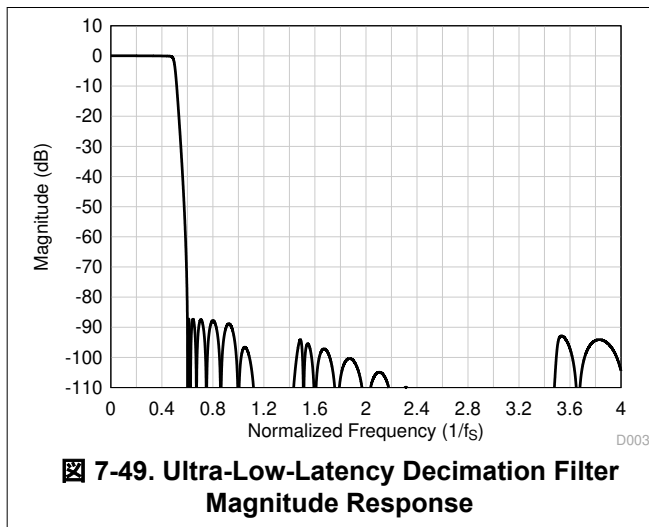

表 7-38. Ultra-Low-Latency Decimation Filter Specifications

| PARAMETER | TEST CONDITIONS | MIN | TYP | MAX | UNIT |
|------------------------|---|--------|-----|-------|---------|
| Pass-band ripple | Frequency range is 0 to $0.46 \times f_s$ | -0.01 | | 0.01 | dB |
| Stop-band attenuation | Frequency range is $0.6 \times f_s$ onwards | 87.1 | | | dB |
| Group delay or latency | Frequency range is 0 to $0.325 \times f_s$ | | 4.1 | | $1/f_s$ |
| Group delay deviation | Frequency range is 0 to $0.325 \times f_s$ | -0.514 | | 0.514 | $1/f_s$ |
| Phase deviation | Frequency range is 0 to $0.325 \times f_s$ | -10.0 | | 14.3 | Degrees |

7.3.6.7.3.3 Sampling Rate: 32 kHz or 29.4 kHz

☒ 7-53 shows the magnitude response and ☒ 7-54 shows the pass-band ripple and phase deviation for a decimation filter with a sampling rate of 32 kHz or 29.4 kHz. 表 7-39 lists the specifications for a decimation filter with an 32-kHz or 29.4-kHz sampling rate.

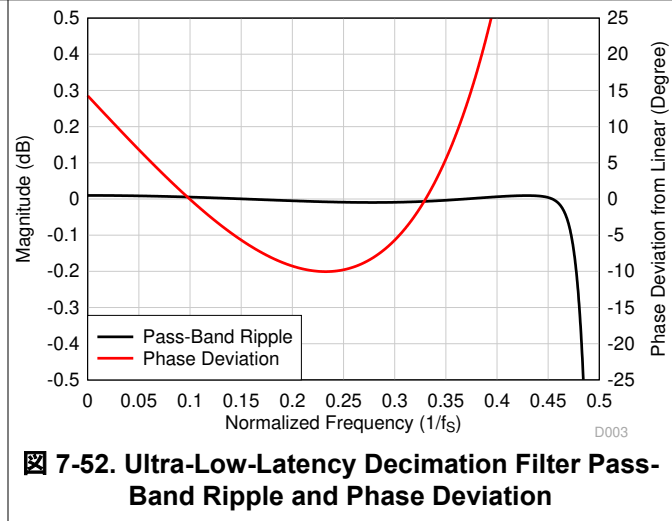
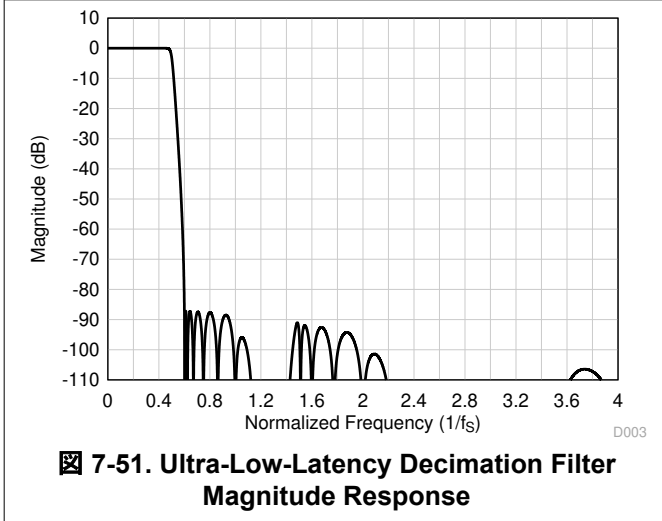

表 7-39. Ultra-Low-Latency Decimation Filter Specifications

| PARAMETER | TEST CONDITIONS | MIN | TYP | MAX | UNIT |
|------------------------|---|--------|-----|-------|---------|
| Pass-band ripple | Frequency range is 0 to $0.457 \times f_S$ | -0.04 | | 0.04 | dB |
| Stop-band attenuation | Frequency range is $0.6 \times f_S$ onwards | 88.3 | | | dB |
| Group delay or latency | Frequency range is 0 to $0.325 \times f_S$ | | 5.2 | | $1/f_S$ |
| Group delay deviation | Frequency range is 0 to $0.325 \times f_S$ | -0.492 | | 0.492 | $1/f_S$ |
| Phase deviation | Frequency range is 0 to $0.325 \times f_S$ | -9.5 | | 13.5 | Degrees |

7.3.6.7.3.4 Sampling Rate: 48 kHz or 44.1 kHz

図 7-55 shows the magnitude response and 図 7-56 shows the pass-band ripple and phase deviation for a decimation filter with a sampling rate of 48 kHz or 44.1 kHz. 表 7-40 lists the specifications for a decimation filter with a 48-kHz or 44.1-kHz sampling rate.

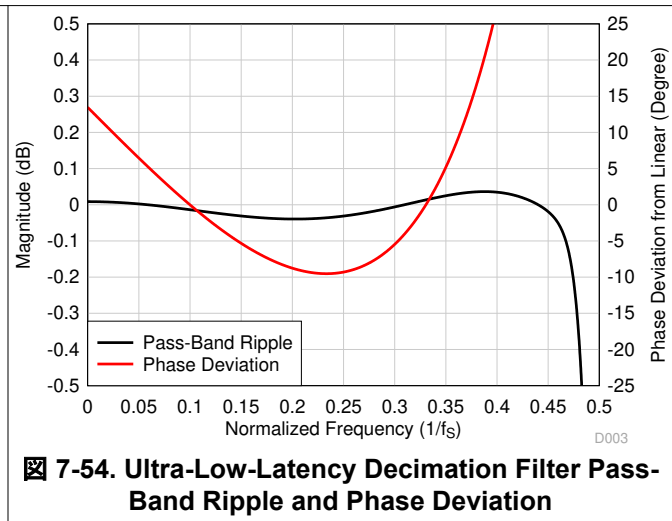
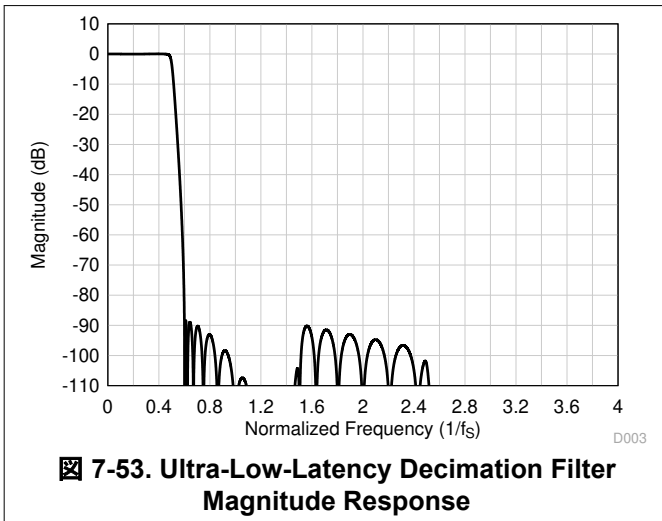

表 7-40. Ultra-Low-Latency Decimation Filter Specifications

| PARAMETER | TEST CONDITIONS | MIN | TYP | MAX | UNIT |
|------------------------|---|--------|-----|-------|---------|
| Pass-band ripple | Frequency range is 0 to $0.452 \times f_S$ | -0.015 | | 0.015 | dB |
| Stop-band attenuation | Frequency range is $0.6 \times f_S$ onwards | 86.4 | | | dB |
| Group delay or latency | Frequency range is 0 to $0.325 \times f_S$ | | 4.1 | | $1/f_S$ |
| Group delay deviation | Frequency range is 0 to $0.325 \times f_S$ | -0.525 | | 0.525 | $1/f_S$ |
| Phase deviation | Frequency range is 0 to $0.325 \times f_S$ | -10.3 | | 14.5 | Degrees |

7.3.6.7.3.5 Sampling Rate: 96 kHz or 88.2 kHz

☒ 7-57 shows the magnitude response and ☒ 7-58 shows the pass-band ripple and phase deviation for a decimation filter with a sampling rate of 96 kHz or 88.2 kHz. 表 7-41 lists the specifications for a decimation filter with a 96-kHz or 88.2-kHz sampling rate.

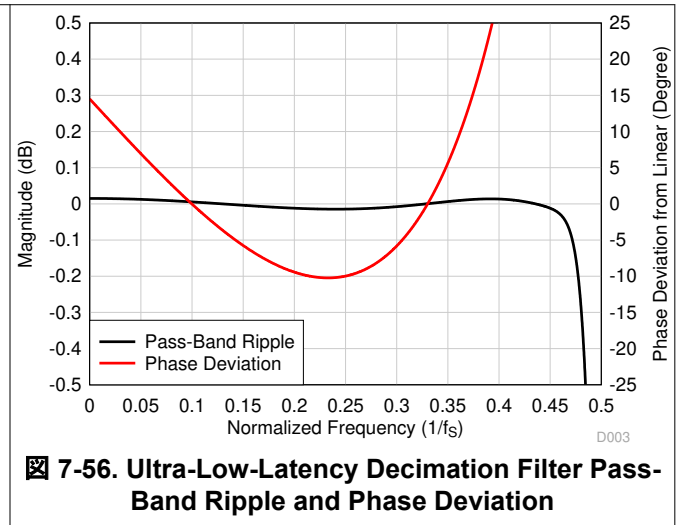
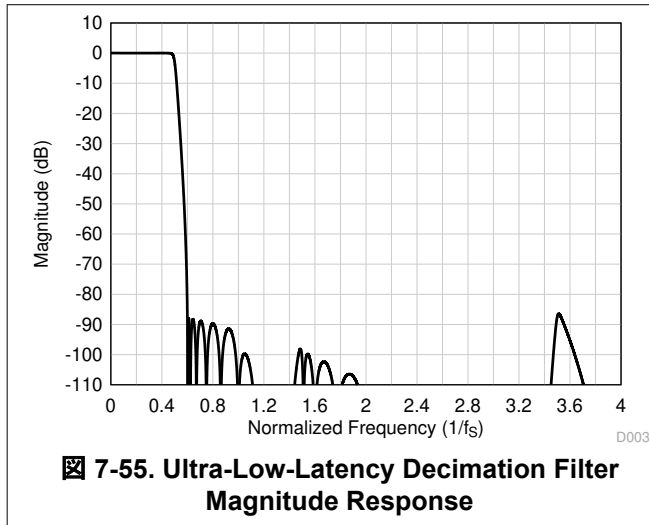

表 7-41. Ultra-Low-Latency Decimation Filter Specifications

| PARAMETER | TEST CONDITIONS | MIN | TYP | MAX | UNIT |
|------------------------|---|--------|-----|-------|---------|
| Pass-band ripple | Frequency range is 0 to $0.466 \times f_s$ | -0.04 | | 0.04 | dB |
| Stop-band attenuation | Frequency range is $0.6 \times f_s$ onwards | 86.3 | | | dB |
| Group delay or latency | Frequency range is 0 to $0.1625 \times f_s$ | | 3.7 | | $1/f_s$ |
| Group delay deviation | Frequency range is 0 to $0.1625 \times f_s$ | -0.091 | | 0.091 | $1/f_s$ |
| Phase deviation | Frequency range is 0 to $0.1625 \times f_s$ | -0.86 | | 1.30 | Degrees |

7.3.6.7.3.6 Sampling Rate 192 kHz or 176.4 kHz

☒ 7-59 shows the magnitude response and ☒ 7-60 shows the pass-band ripple and phase deviation for a decimation filter with a sampling rate of 192 kHz or 176.4 kHz. 表 7-42 lists the specifications for a decimation filter with a 192-kHz or 176.4-kHz sampling rate.

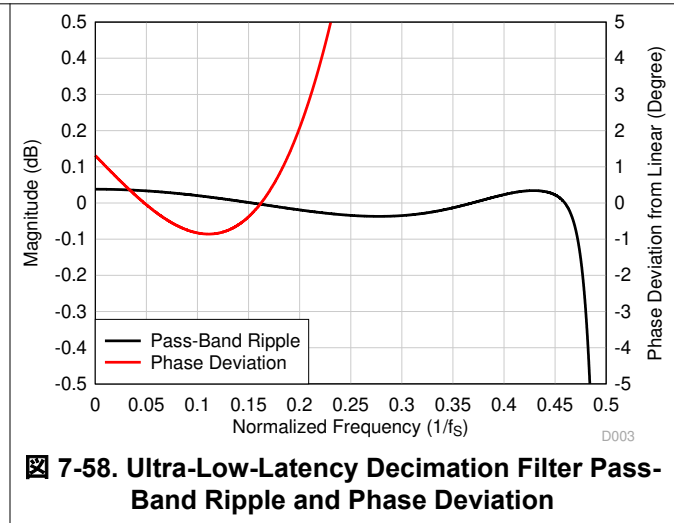
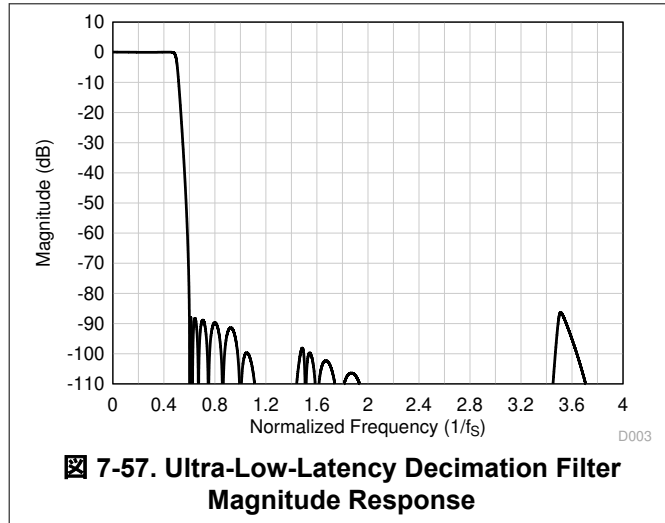

表 7-42. Ultra-Low-Latency Decimation Filter Specifications

| PARAMETER | TEST CONDITIONS | MIN | TYP | MAX | UNIT |
|------------------------|---|--------|-----|-------|---------|
| Pass-band ripple | Frequency range is 0 to $0.463 \times f_S$ | -0.03 | | 0.03 | dB |
| Stop-band attenuation | Frequency range is $0.6 \times f_S$ onwards | 85.6 | | | dB |
| Group delay or latency | Frequency range is 0 to $0.085 \times f_S$ | | 3.7 | | $1/f_S$ |
| Group delay deviation | Frequency range is 0 to $0.085 \times f_S$ | -0.024 | | 0.024 | $1/f_S$ |
| Phase deviation | Frequency range is 0 to $0.085 \times f_S$ | -0.12 | | 0.18 | Degrees |

7.3.6.7.3.7 Sampling Rate 384 kHz or 352.8 kHz

図 7-61 shows the magnitude response and 図 7-62 shows the pass-band ripple and phase deviation for a decimation filter with a sampling rate of 384 kHz or 352.8 kHz. 表 7-43 lists the specifications for a decimation filter with a 384-kHz or 352.8-kHz sampling rate.

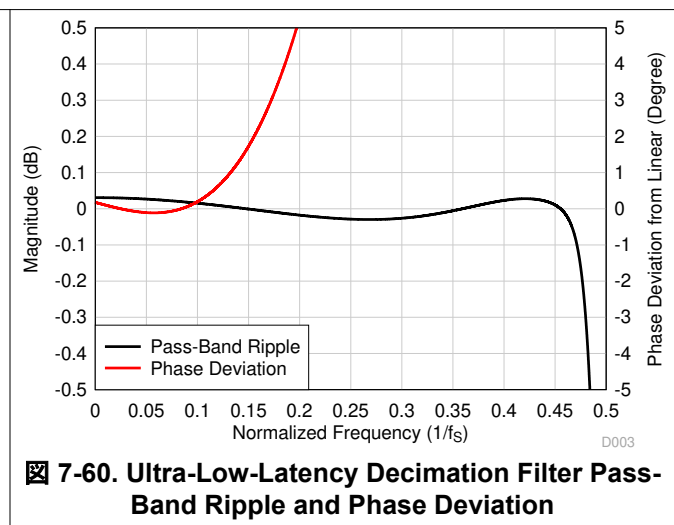
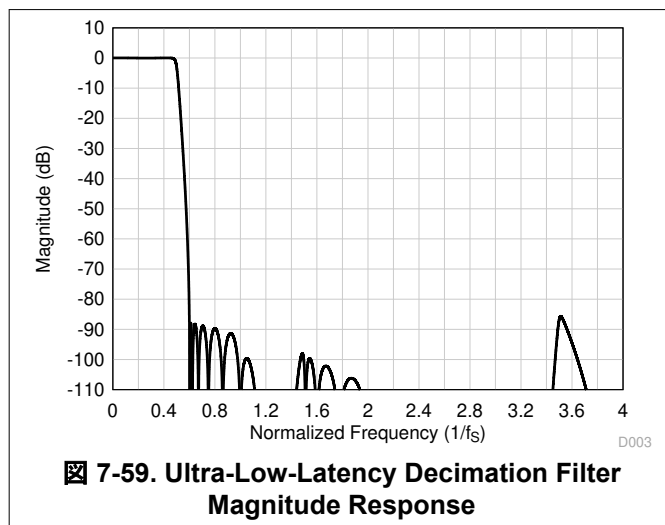

表 7-43. Ultra-Low-Latency Decimation Filter Specifications

| PARAMETER | TEST CONDITIONS | MIN | TYP | MAX | UNIT |
|------------------------|--|-------|-----|------|---------|
| Pass-band ripple | Frequency range is 0 to $0.1 \times f_S$ | -0.04 | | 0.01 | dB |
| Stop-band attenuation | Frequency range is $0.56 \times f_S$ onwards | 70.1 | | | dB |
| Group delay or latency | Frequency range is 0 to $0.157 \times f_S$ | | 4.1 | | $1/f_S$ |
| Group delay deviation | Frequency range is 0 to $0.157 \times f_S$ | -0.18 | | 0.18 | $1/f_S$ |
| Phase deviation | Frequency range is 0 to $0.157 \times f_S$ | -0.85 | | 2.07 | Degrees |

7.3.7 Dynamic Range Enhancer (DRE)

The device integrates an ultra-low noise front-end PGA with 120dB dynamic range performance with a low-noise, low-distortion, multibit delta-sigma ($\Delta\Sigma$) ADC with a 113dB dynamic range. The dynamic range enhancer (DRE) is a digitally assisted algorithm to boost the overall channel performance. The DRE monitors the incoming signal amplitude and accordingly adjusts the internal PGA gain automatically. The DRE achieves a complete-channel dynamic range as high as 120dB. At a system level, the DRE scheme enables far-field, high-fidelity recording of audio signals in very quiet environments and low-distortion recording in loud environments.

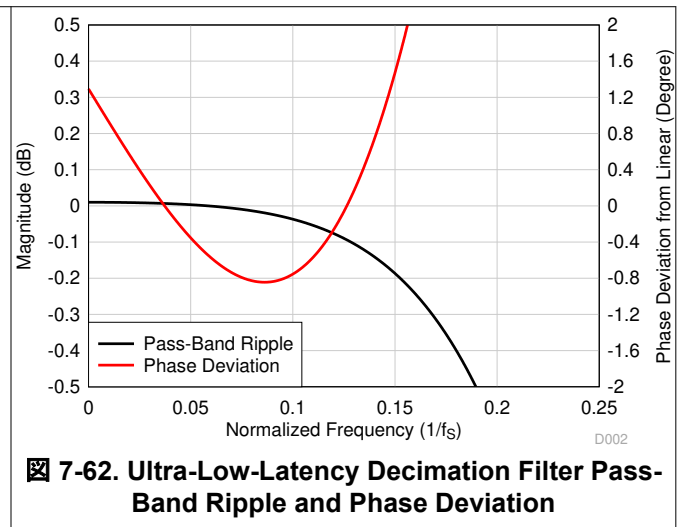
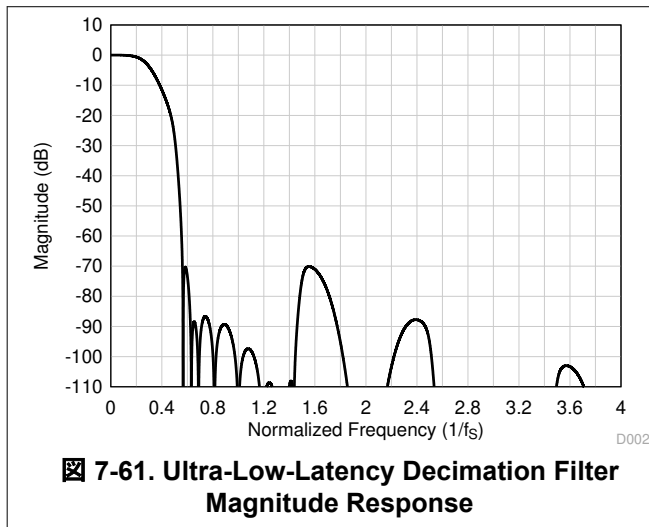
This algorithm is implemented with very low latency and all signal chain blocks are designed to minimize any audible artifacts that may occur resulting from dynamic gain modulation. Additionally, the host can configure the target signal threshold level at which DRE is triggered by setting the appropriate value for the DRE_LVL[3:0], P0_R109[7:4] register bits. The DRE_LVL default level is set to –54dB and TI recommends setting the DRE_LVL value lower than –30dB to maximize the benefit of the DRE in real-world applications and to minimize any audible artifacts. 表 7-44 lists the DRE_LVL configuration settings.

表 7-44. DRE Trigger Threshold Level Programmable Settings

| P0_R109_D[7:4] : DRE_LVL[3:0] | DRE TRIGGER THRESHOLD LEVEL |
|-------------------------------|--|
| 0000 | The DRE trigger threshold is the –12-dB input signal level |
| 0001 | The DRE trigger threshold is the –18-dB input signal level |
| 0010 | The DRE trigger threshold is the –24-dB input signal level |
| ... | ... |
| 0111 (default) | The DRE trigger threshold is the –54-dB input signal level |
| ... | ... |
| 1001 | The DRE trigger threshold is the –66-dB input signal level |
| 1010 to 1111 | Reserved (do not use these settings) |

The DRE gain range can be dynamically modulated by using the DRE_MAXGAIN[3:0], P0_R109[3:0] register bits. The DRE_MAXGAIN default value is set to 24 dB, and the DRE_MAXGAIN value is recommended to be set lower than 24 dB to maximize the benefit of the DRE in real-world applications and to minimize any audible artifacts. 表 7-45 lists the DRE_MAXGAIN configuration settings.

表 7-45. DRE Maximum Gain Programmable Settings

| P0_R109_D[3:0] : DRE_MAXGAIN[3:0] | DRE MAXIMUM GAIN ALLOWED |
|-----------------------------------|---------------------------------------|
| 0000 | The DRE maximum gain allowed is 2 dB |
| 0001 | The DRE maximum gain allowed is 4 dB |
| 0010 | The DRE maximum gain allowed is 6 dB |
| ... | ... |
| 1011 (default) | The DRE maximum gain allowed is 24 dB |
| ... | ... |
| 1110 | The DRE maximum gain allowed is 30 dB |
| 1111 | Reserved (do not use this setting) |

The DRE scheme is only supported for analog microphone recording channels with an AC-coupled input for best dynamic range performance. The DRE scheme can be independently enabled or disabled for each channel using the CH1_DREEN (P0_R60_D0), CH2_DREEN (P0_R65_D0), CH3_DREEN (P0_R70_D0), and CH4_DREEN (P0_R75_D0) register bits. For a DC-coupled input, the DRE scheme can be used with limited DRE_MAXGAIN depending on the DC differential input common-mode offset.

Enabling the DRE for processing increases the power consumption of the device because of increased signal processing. Therefore, disable the DRE for low-power critical applications. Furthermore, the DRE is not supported for output sample rates greater than 192 kHz .

7.3.8 Automatic Gain Controller (AGC)

The device includes an automatic gain controller (AGC) for ADC recording. As shown in 図 7-63, the AGC can be used to maintain a nominally constant output level when recording speech. Instead of manually setting the channel gain in AGC mode, the circuitry automatically adjusts the channel gain when the input signal becomes overly loud or very weak, such as when a person speaking into a microphone moves closer to or farther from the microphone. The AGC algorithm has several programmable parameters, including target level, maximum gain allowed, attack and release (or decay) time constants, and noise thresholds that allow the algorithm to be fine-tuned for any particular application.



図 7-63. AGC Characteristics

The target level (AGC_LVL) represents the nominal approximate output level at which the AGC attempts to hold the ADC output signal level. The PCM5140-Q1 allows programming of different target levels, which can be programmed from -6 dB to -36 dB relative to a full-scale signal, and the AGC_LVL default value is set to -34 dB. The target level is recommended to be set with enough margin to prevent clipping when loud sounds occur. 表 7-46 lists the AGC target level configuration settings.

表 7-46. AGC Target Level Programmable Settings

| P0_R112_D[7:4] : AGC_LVL[3:0] | AGC TARGET LEVEL FOR OUTPUT |
|-------------------------------|---|
| 0000 | The AGC target level is the -6 -dB output signal level |
| 0001 | The AGC target level is the -8 -dB output signal level |
| 0010 | The AGC target level is the -10 -dB output signal level |
| ... | ... |
| 1110 (default) | The AGC target level is the -34 -dB output signal level |
| 1111 | The AGC target level is the -36 -dB output signal level |

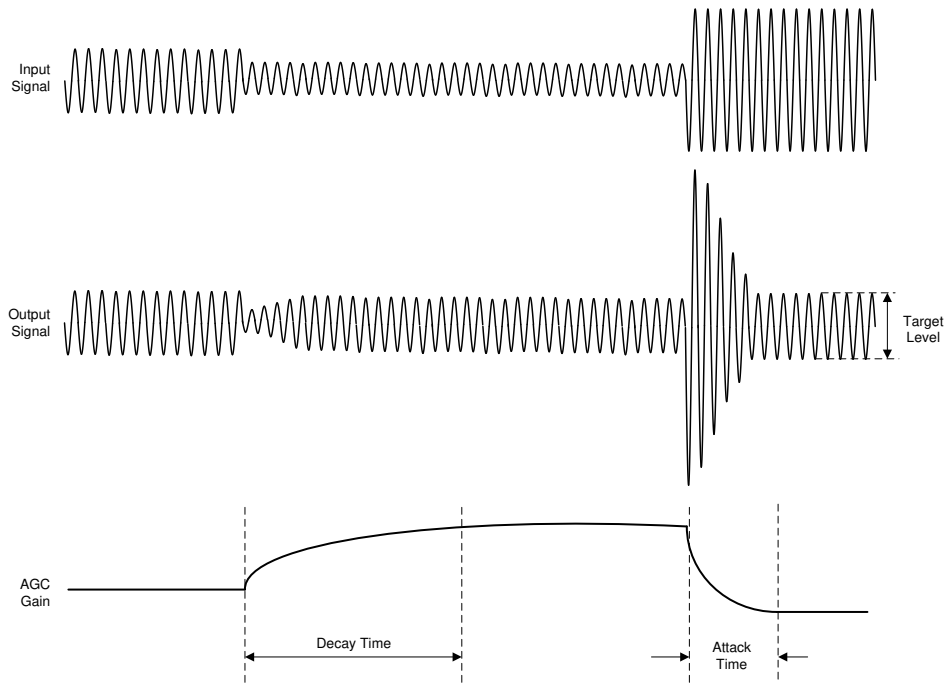
The maximum gain allowed (AGC_MAXGAIN) gives flexibility to the designer to restrict the maximum gain applied by the AGC. This feature limits the channel gain in situations where environmental noise is greater than the programmed noise threshold. The AGC_MAXGAIN can be programmed from 3 dB to 42 dB with steps of 3 dB and the default value is set to 24 dB. [表 7-47](#) lists the AGC_MAXGAIN configuration settings.

表 7-47. AGC Maximum Gain Programmable Settings

| P0_R112_D[3:0] : AGC_MAXGAIN[3:0] | AGC MAXIMUM GAIN ALLOWED |
|--------------------------------------|---------------------------------------|
| 0000 | The AGC maximum gain allowed is 3 dB |
| 0001 | The AGC maximum gain allowed is 6 dB |
| 0010 | The AGC maximum gain allowed is 9 dB |
| ... | ... |
| 0111 (default) | The AGC maximum gain allowed is 24 dB |
| ... | ... |
| 1110 | The AGC maximum gain allowed is 39 dB |
| 1111 | The AGC maximum gain allowed is 42 dB |

For further details on the AGC various configurable parameter and application use, see the [Using the Automatic Gain Controller \(AGC\) in TLV320ADCx140 application report](#).

7.3.9 Digital PDM Microphone Record Channel

In addition to supporting analog microphones, the device also interfaces to digital pulse-density-modulation (PDM) microphones and uses high-order and high-performance decimation filters to generate pulse code modulation (PCM) output data that can be transmitted on the audio serial interface to the host. If analog microphones are not used in the system, then the analog input pins (INxP and INxM) can be repurposed as the GPIx and GPOx pins respectively and can be configured for the PDMCLK and PDMCLK clocks for digital PDM microphone recording. The device supports up to eight digital microphone recording channels.

The device internally generates PCMCLK with a programmable frequency of either 6.144 MHz, 3.072 MHz, 1.536 MHz, or 768 kHz (for output data sample rates in multiples or submultiples of 48 kHz) or 5.6448 MHz, 2.8224 MHz, 1.4112 MHz, or 705.6 kHz (for output data sample rates in multiples or submultiples of 44.1 kHz) using the PDMCLK_DIV[1:0], P0_R31_D[1:0] register bits. PDMCLK can be routed on the GPOx pin. This clock can be connected to the external digital microphone device. [Figure 7-64](#) shows a connection diagram of the digital PDM microphones.

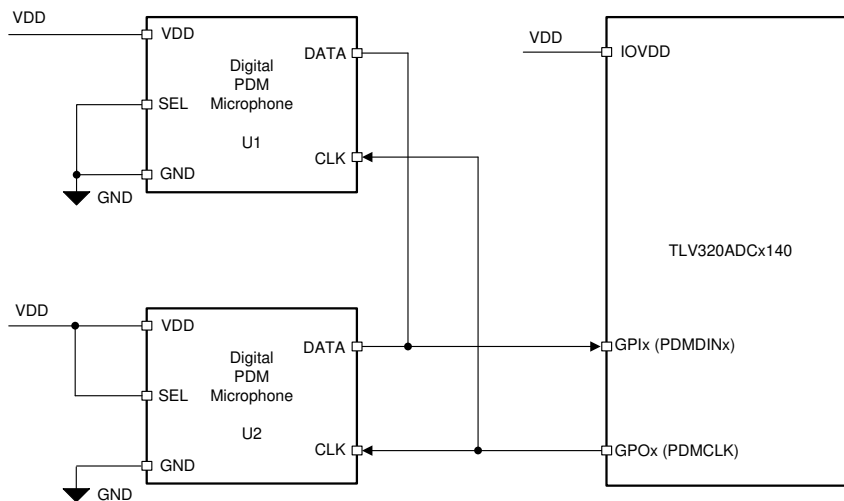

Figure 7-64. Digital PDM Microphones Connection Diagram to the PCM5140-Q1

The single-bit output of the external digital microphone device can be connected to the GPIx pin. This single data line can be shared by two digital microphones to place their data on the opposite edge of PDMCLK. Internally, the device latches the steady value of the data on the rising edge of PDMCLK or the falling edge of PDMCLK based on the configuration register bits set in P0_R32_D[7:4]. [Figure 7-65](#) shows the digital PDM microphone interface timing diagram.

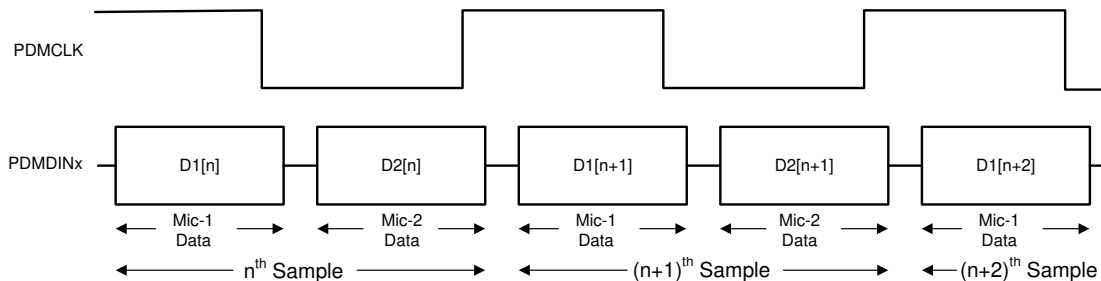

Figure 7-65. Digital PDM Microphone Protocol Timing Diagram

When the digital microphone is used for recording, the analog blocks of the respective ADC channel are powered down and bypassed for power efficiency. Use the CH1_INSRC[1:0] (P0_R60_D[6:5]), CH2_INSRC[1:0] (P0_R65_D[6:5]), CH3_INSRC[1:0] (P0_R70_D[6:5]), and CH4_INSRC[1:0] (P0_R75_D[6:5]) register bits to select the analog microphone or digital microphone for channel 1 to channel 4.

7.3.10 Interrupts, Status, and Digital I/O Pin Multiplexing

Certain events in the device may require host processor intervention and can be used to trigger interrupts to the host processor. One such event is an audio serial interface (ASI) bus error. The device powers down the record channels if any faults are detected with the ASI bus error clocks, such as:

- Invalid FSYNC frequency
- Invalid SBCLK to FSYNC ratio
- Long pauses of the SBCLK or FSYNC clocks

When an ASI bus clock error is detected, the device shuts down the record channel as quickly as possible. After all ASI bus clock errors are resolved, the device volume ramps back to its previous state to recover the record channel. During an ASI bus clock error, the internal interrupt request (IRQ) interrupt signal asserts low if the clock error interrupt mask register bit INT_MASK0[7], P0_R51_D7 is set low. The clock fault is also available for readback in the latched fault status register bit INT_LTCH0, P0_R54, which is a read-only register. Reading the latched fault status register, INT_LTCH0, clears all latched fault status. The device can be additionally configured to route the internal IRQ interrupt signal on the GPIO1 or GPOx pins and also can be configured as open-drain outputs so that these pins can be wire-ANDed to the open-drain interrupt outputs of other devices.

The IRQ interrupt signal can either be configured as active low or active high polarity by setting the INT_POL, P0_R50_D7 register bit. This signal can also be configured as a single pulse or a series of pulses by programming the INT_EVENT[1:0], P0_R50_D[6:5] register bits. If the interrupts are configured as a series of pulses, the events trigger the start of pulses that stop when the latched fault status register is read to determine the cause of the interrupt.

The device also supports read-only live-status registers to determine if the channels are powered up or down and if the device is in sleep mode or not. These status registers are located in P0_R118, DEV_STS0 and P0_R119, DEV_STS1.

The device has a multifunctional GPIO1 pin that can be configured for a desired specific function. Additionally, if the channel is not used for analog input recording, then the analog input pins for that channel (INxP and INxM) can be repurposed as multifunction pins (GPIx and GPOx) by configuring the CHx_INSRC[1:0] register bits located in the CHx_CFG0 register. The maximum number of GPO pins supported by the device is four and the maximum number of GPI pins are four. 表 7-48 shows all possible allocations of these multifunctional pins for the various features.

表 7-48. Multifunction Pin Assignments

| ROW | Pin Function ⁽⁴⁾ | GPIO1 | GPO1 | GPO2 | GPO3 | GPO4 | GPI1 | GPI2 | GPI3 | GPI4 |
|----------|--|------------------|-------------|-------------|-------------|-------------|-------------------|-------------|-------------|-------------|
| — | — | GPIO1_CFG | GPO1_CFG | GPO2_CFG | GPO3_CFG | GPO4_CFG | GPI1_CFG | GPI2_CFG | GPI3_CFG | GPI4_CFG |
| — | — | P0_R33[7:4] | P0_R34[7:4] | P0_R35[7:4] | P0_R36[7:4] | P0_R37[7:4] | P0_R43[6:4] | P0_R43[2:0] | P0_R44[6:4] | P0_R44[2:0] |
| A | Pin disabled | S ⁽¹⁾ | S (default) | S (default) | S (default) | S (default) | S (default) | S (default) | S (default) | S (default) |
| B | General-purpose output (GPO) | S | S | S | S | S | NS ⁽²⁾ | NS | NS | NS |
| C | Interrupt output (IRQ) | S (default) | S | S | S | S | NS | NS | NS | NS |
| D | Secondary ASI output (SDOUT2) ⁽³⁾ | S | S | S | S | S | NS | NS | NS | NS |
| E | PDM clock output (PDMCLK) | S | S | S | S | S | NS | NS | NS | NS |
| F | MiCBIAS on/off input (BIASEN) | S | NS | NS | NS | NS | NS | NS | NS | NS |
| G | General-purpose input (GPI) | S | NS | NS | NS | NS | S | S | S | S |
| H | Master clock input (MCLK) | S | NS | NS | NS | NS | S | S | S | S |
| I | ASI daisy-chain input (SDIN) | S | NS | NS | NS | NS | S | S | S | S |
| J | PDM data input 1 (PDMIN1) | S | NS | NS | NS | NS | S | S | S | S |
| K | PDM data input 2 (PDMIN2) | S | NS | NS | NS | NS | S | S | S | S |
| L | PDM data input 3 (PDMIN3) | S | NS | NS | NS | NS | S | S | S | S |

表 7-48. Multifunction Pin Assignments (続き)

| ROW | Pin Function ⁽⁴⁾ | GPIO1 | GPO1 | GPO2 | GPO3 | GPO4 | GPI1 | GPI2 | GPI3 | GPI4 |
|-----|-----------------------------|-------|------|------|------|------|------|------|------|------|
| M | PDM data input 4 (PDMDIN4) | S | NS | NS | NS | NS | S | S | S | S |

- (1) S means the feature mentioned in this row is *supported* for the respective GPIO1, GPOx, or GPIx pin mentioned in this column.
- (2) NS means the feature mentioned in this row is *not supported* for the respective GPIO1, GPOx, or GPIx pin mentioned in this column.
- (3) For the high-speed ASI output, GPIO1 must be used instead of GPOx for the secondary ASI output. GPOx can be used only if the bus speed requirement is less than 6.144 MHz.
- (4) Only the GPIO1 pin is with reference to the IOVDD supply, the other GPOx and GPIx pins are with reference to the AVDD supply and their primary pin functions are for the PDMCLK or PDMDIN function.

The GPIO1 drive strength can be configured with the GPIO1_DRV[2:0](P0_R33) register bits. [GPIO1 Drive Configuration Settings](#) lists the drive configuration settings available. Similarly, the GPOx pins can be configured using the GPOx_DRV[0] (P0_R33-37) bit. However only Hi-Z and Active High/Active Low drive options are available. [GPOx Drive Configuration Settings](#) shows the configuration options for GPO1. The same options are available in GPO2, 3, and 4.

表 7-49. GPIO or GPOx Pins Drive Configuration Settings

| P0_R33_D[2:0] : GPIO1_DRV[2:0] | GPIO OUTPUT DRIVE CONFIGURATION SETTINGS FOR GPIO1 |
|--------------------------------|--|
| 000 | The GPIO1 pin is set to high impedance (floated) |
| 001 | The GPIO1 pin is set to be driven active low or active high |
| 010 (default) | The GPIO1 pin is set to be driven active low or weak high (on-chip pullup) |
| 011 | The GPIO1 pin is set to be driven active low or Hi-Z (floated) |
| 100 | The GPIO1 pin is set to be driven weak low (on-chip pulldown) or active high |
| 101 | The GPIO1 pin is set to be driven Hi-Z (floated) or active high |
| 110 and 111 | Reserved (do not use these settings) |

表 7-50. GPOx Drive Configuration Settings

| P0_R34_D[0] : GPO1_DRV[0] | GPO1 OUTPUT DRIVE CONFIGURATION SETTINGS FOR GPO1 |
|---------------------------|--|
| 000 | The GPO1 pin is set to high impedance (floated) |
| 001 | The GPO1 pin is set to be driven active low or active high |

When configured as a general-purpose output (GPO), the GPIO1 or GPOx pin values can be driven by writing the GPIO_VAL or GPOx_VAL, P0_R41 registers. The GPIO_MON, P0_R42 register can be used to readback the status of the GPIO1 pin when configured as a general-purpose input (GPI). Similarly, the GPI_MON, P0_R47 register can be used to readback the status of the GPIx pins when configured as a general-purpose input (GPI).

7.4 Device Functional Modes

7.4.1 Hardware Shutdown

The device enters hardware shutdown mode when the SHDNZ pin is asserted low or the AVDD supply voltage is not applied to the device. In hardware shutdown mode, the device consumes the minimum quiescent current from the AVDD supply. All configuration registers and programmable coefficients lose their value in this mode, and I²C or SPI communication to the device is not supported.

If the SHDNZ pin is asserted low when the device is in active mode, the device ramps down volume on the record data, powers down the analog and digital blocks, and puts the device into hardware shutdown mode in 25 ms (typical). The device can also be immediately put into hardware shutdown mode from active mode if the SHDNZ_CFG[1:0], P0_R5_D[3:2], register bits are set to 2'b00. After the SHDNZ pin is asserted low, and after the device enters hardware shutdown mode, keep the SHDNZ pin low for at least 1 ms before releasing SHDNZ for further device operation.

Assert the SHDNZ pin high only when the IOVDD supply settles to a steady voltage level. When the SHDNZ pin goes high, the device sets all configuration registers and programmable coefficients to their default values, and then enters sleep mode.

7.4.2 Sleep Mode or Software Shutdown

In sleep mode or software shutdown mode, the device consumes very low quiescent current from the AVDD supply and, at the same time, allows the I²C or SPI communication to wake the device for active operation.

The device can also enter sleep mode when the host device sets the SLEEP_ENZ, P0_R2_D0 bit to 1'b0. If the SLEEP_ENZ bit is asserted low when the device is in active mode, the device ramps down the volume on the record data, powers down the analog and digital blocks, and enters sleep mode. However, the device still continues to retain the last programmed value of the device configuration registers and programmable coefficients.

In sleep mode, do not perform any I²C or SPI transactions, except for exiting sleep mode in order to enter active mode. After entering sleep mode, wait at least 10 ms before starting I²C or SPI transactions to exit sleep mode.

While exiting sleep mode, the host device must configure the PCM5140-Q1 to use either an external 1.8-V AREG supply (default setting) or an on-chip-regulator-generated AREG supply. To configure the AREG supply, write to AREG_SELECT, bit D7 in the same P0_R2 register.

7.4.3 Active Mode

If the host device exits sleep mode by setting the SLEEP_ENZ bit to 1'b1, the device enters active mode. In active mode, I²C or SPI transactions can be done to configure and power-up the device for active operation. After entering active mode, wait at least 1 ms before starting any I²C or SPI transactions in order to allow the device to complete the internal wake-up sequence.

After configuring all other registers for the target application and system settings, configure the input and output channel enable registers, P0_R115 (IN_CH_EN) and P0_R116 (ASI_OUT_CH_EN), respectively. Lastly, configure the device power-up register, P0_R117 (PWR_CFG). All the programmable coefficient values must be written before powering up the respective channel.

In active mode, the power-up and power-down status of various blocks is monitored by reading the read-only device status bits located in the P0_R117 (DEV_STS0) and P0_R118 (DEV_STS1) registers.

7.4.4 Software Reset

A software reset can be done any time by asserting the SW_RESET bit, P0_R1_D0, which is a self-clearing bit. This software reset immediately shuts down the device, and restores all device configuration registers and programmable coefficients to their default values.

7.5 Programming

The device contains configuration registers and programmable coefficients that can be set to the desired values for a specific system and application use. These registers are called *device control registers* and are each eight bits in width, mapped using a page scheme.

Each page contains 128 configuration registers. All device configuration registers are stored in page 0, which is the default page setting at power up and after a software reset. All programmable coefficient registers are located in page 2, page 3, and page 4. The current page of the device can be switched to a new desired page by using the PAGE[7:0] bits located in register 0 of every page.

7.5.1 Control Serial Interfaces

The device control registers can be accessed using either I²C or SPI communication to the device.

By monitoring the SDA_S2Z, SCL_MOSI, ADDR0_SCLK, and ADDR1_MISO device pins, which are the multiplexed pins for the I²C or SPI Interface, the device automatically detects whether the host device is using I²C or SPI communication to configure the device. For a given end application, the host device must always use either the I²C or SPI interface, but not both, to configure the device.

7.5.1.1 I²C Control Interface

The device supports the I²C control protocol as a slave device, and is capable of operating in standard mode, fast mode, and fast mode plus. The I²C control protocol requires a 7-bit slave address. The five most significant bits (MSBs) of the slave address are fixed at 10011 and cannot be changed. The two least significant bits (LSBs) are programmable and are controlled by the ADDR0_SCLK and ADDR1_MISO pins. These two pins must always be either pulled to VSS or IOVDD. If the I2C_BRDCAST_EN (P0_R2_D2) bit is set to 1'b1, then the I²C slave address is fixed to 1001100 in order to allow simultaneous I²C broadcast communication to all PCM5140-Q1 devices in the system. 表 7-51 lists the four possible device addresses resulting from this configuration.

表 7-51. I²C Slave Address Settings

| ADDR1_MISO | ADDR0_SCLK | I2C_BRDCAST_EN (P0_R2_D2) | I ² C SLAVE ADDRESS |
|------------|------------|---------------------------|--------------------------------|
| 0 | 0 | 0 (default) | 1001 100 |
| 0 | 1 | 0 (default) | 1001 101 |
| 1 | 0 | 0 (default) | 1001 110 |
| 1 | 1 | 0 (default) | 1001 111 |
| X | X | 1 | 1001 100 |

7.5.1.1.1 General I²C Operation

The I²C bus employs two signals, SDA (data) and SCL (clock), to communicate between integrated circuits in a system using serial data transmission. The address and data 8-bit bytes are transferred MSB first. In addition, each byte transferred on the bus is acknowledged by the receiving device with an acknowledge bit. Each transfer operation begins with the controller device driving a start condition on the bus and ends with the controller device driving a stop condition on the bus. The bus uses transitions on the data pin (SDA) while the clock is at logic high to indicate start and stop conditions. A high-to-low transition on SDA indicates a start, and a low-to-high transition indicates a stop. Normal data-bit transitions must occur within the low time of the clock period.

The controller device drives a start condition followed by the 7-bit slave address and the read/write (R/W) bit to open communication with another device and then waits for an acknowledgment condition. The slave device holds SDA low during the acknowledge clock period to indicate acknowledgment. When this occurs, the controller device transmits the next byte of the sequence. Each slave device is addressed by a unique 7-bit slave address plus the R/W bit (1 byte). All compatible devices share the same signals via a bidirectional bus using a wired-AND connection.

There is no limit on the number of bytes that can be transmitted between start and stop conditions. When the last word transfers, the controller device generates a stop condition to release the bus. [Figure 7-66](#) shows a generic data transfer sequence.

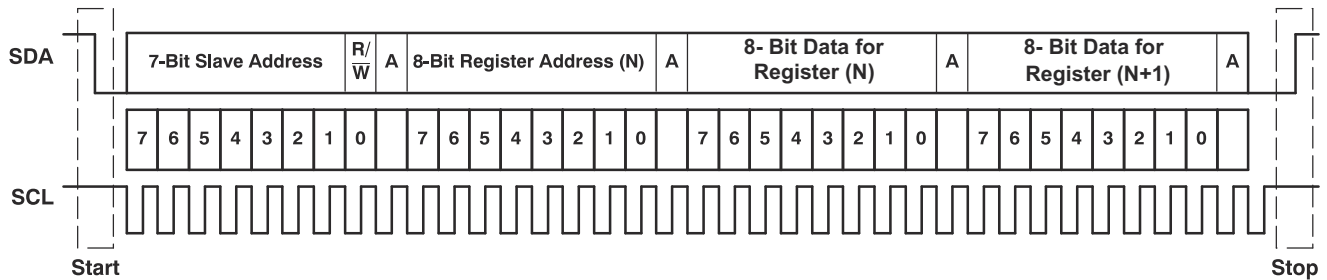

Figure 7-66. Typical I²C Sequence

In the system, use external pullup resistors for the SDA and SCL signals to set the logic high level for the bus. The SDA and SCL voltages must not exceed the device supply voltage, IOVDD.

7.5.1.1.2 I²C Single-Byte and Multiple-Byte Transfers

The device I²C interface supports both single-byte and multiple-byte read/write operations for all registers. During multiple-byte read operations, the device responds with data, a byte at a time, starting at the register assigned, as long as the controller device continues to respond with acknowledges.

The device supports sequential I²C addressing. For write transactions, if a register is issued followed by data for that register and all the remaining registers that follow, a sequential I²C write transaction takes place. For I²C sequential write transactions, the register issued then serves as the starting point, and the amount of data subsequently transmitted, before a stop or start is transmitted, determines how many registers are written.

7.5.1.1.2.1 I²C Single-Byte Write

As shown in [Figure 7-67](#), a single-byte data write transfer begins with the controller device transmitting a start condition followed by the I²C device address and the read/write bit. The read/write bit determines the direction of the data transfer. For a write-data transfer, the read/write bit must be set to 0. After receiving the correct I²C slave address and the read/write bit, the device responds with an acknowledge bit (ACK). Next, the controller device transmits the register byte corresponding to the device internal register address being accessed. After receiving the register byte, the device again responds with an acknowledge bit (ACK). Then, the controller transmits the byte of data to be written to the specified register. When finished, the slave device responds with an acknowledge bit (ACK). Finally, the controller device transmits a stop condition to complete the single-byte data write transfer.

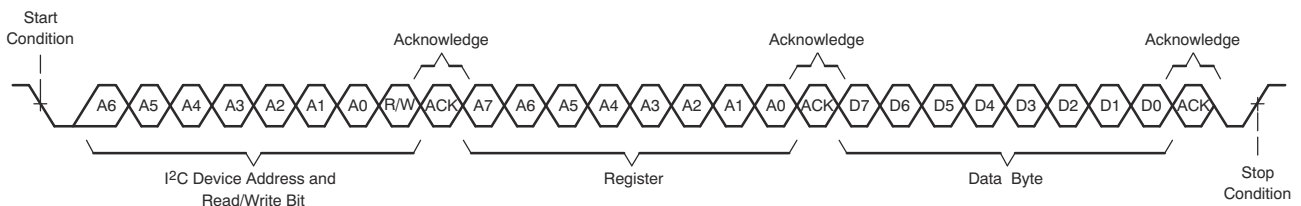

Figure 7-67. I²C Single-Byte Write Transfer

7.5.1.1.2.2 I²C Multiple-Byte Write

As shown in [Figure 7-68](#), a multiple-byte data write transfer is identical to a single-byte data write transfer except that multiple data bytes are transmitted by the controller device to the slave device. After receiving each data byte, the device responds with an acknowledge bit (ACK). Finally, the controller device transmits a stop condition after the last data-byte write transfer.

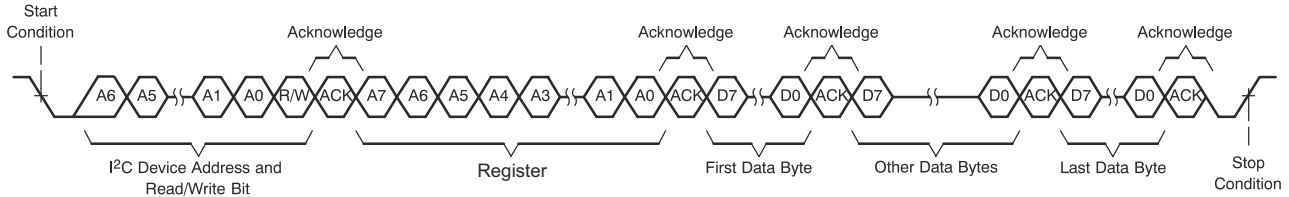

Figure 7-68. I²C Multiple-Byte Write Transfer

7.5.1.1.2.3 I²C Single-Byte Read

As shown in [Figure 7-69](#), a single-byte data read transfer begins with the controller device transmitting a start condition followed by the I²C slave address and the read/write bit. For the data read transfer, both a write followed by a read are done. Initially, a write is done to transfer the address byte of the internal register address to be read. As a result, the read/write bit is set to 0.

After receiving the slave address and the read/write bit, the device responds with an acknowledge bit (ACK). The controller device then sends the internal register address byte, after which the device issues an acknowledge bit (ACK). The controller device transmits another start condition followed by the slave address and the read/write bit again. This time, the read/write bit is set to 1, indicating a read transfer. Next, the device transmits the data byte from the register address being read. After receiving the data byte, the controller device transmits a not-acknowledge (NACK) followed by a stop condition to complete the single-byte data read transfer.

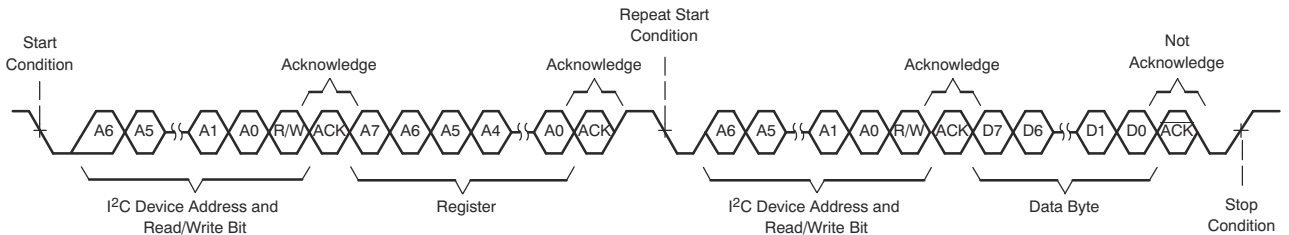

Figure 7-69. I²C Single-Byte Read Transfer

7.5.1.1.2.4 I²C Multiple-Byte Read

As shown in [Figure 7-70](#), a multiple-byte data read transfer is identical to a single-byte data read transfer except that multiple data bytes are transmitted by the device to the controller device. With the exception of the last data byte, the controller device responds with an acknowledge bit after receiving each data byte. After receiving the last data byte, the controller device transmits a not-acknowledge (NACK) followed by a stop condition to complete the data read transfer.

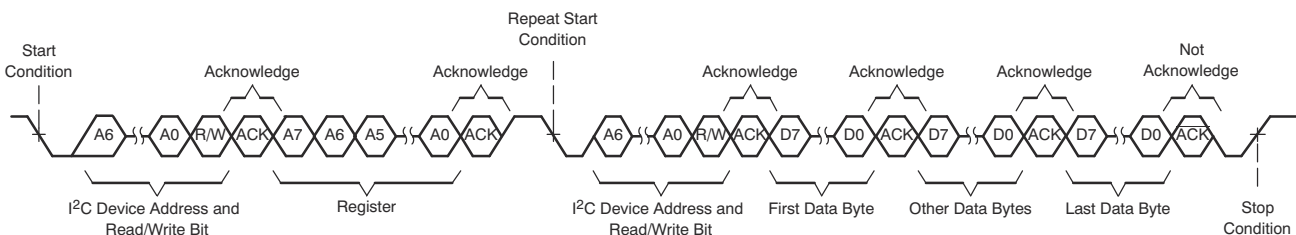

Figure 7-70. I²C Multiple-Byte Read Transfer

7.5.1.2 SPI Control Interface

The general SPI protocol allows full-duplex, synchronous, serial communication between a host processor (the controller) and peripheral devices (slaves). The SPI controller (in this case, the host processor) generates the synchronizing clock (driven onto SCLK) and initiates transmissions by taking the slave-select pin SSZ from high to low. The SPI slave devices (such as the PCM5140-Q1) depend on a controller to start and synchronize transmissions. A transmission begins when initiated by an SPI controller. The byte from the SPI controller begins shifting in on the slave MOSI pin under the control of the controller serial clock (driven onto SCLK). When the byte shifts in on the MOSI pin, a byte shifts out on the MISO pin to the controller shift register.

The PCM5140-Q1 supports a standard SPI control protocol with a clock polarity setting of 0 (typical microprocessor SPI control bit CPOL = 0) and a clock phase setting of 1 (typical microprocessor SPI control bit CPHA = 1). The SSZ pin can remain low between transmissions; however, the device only interprets the first eight bits transmitted after the falling edge of SSZ as a command byte, and the next eight bits as a data byte only if writing to a register. The device is entirely controlled by registers. Reading and writing these registers is accomplished by an 8-bit command sent to the MOSI pin prior to the data for that register. 表 7-52 shows the command structure. The first seven bits specify the address of the register that is being written or read, from 0 to 127 (decimal). The command word ends with an R/W bit, which specifies the direction of data flow on the serial bus.

In the case of a register write, set the R/W bit to 0. A second byte of data is sent to the MOSI pin and contains the data to be written to the register. A register read is accomplished in a similar fashion. The 8-bit command word sends the 7-bit register address, followed by the R/W bit equal to 1 to signify a register read. The 8-bit register data is then clocked out of the device on the MISO pin during the second eight SCLK clocks in the frame. The device supports sequential SPI addressing for a multiple-byte data write/read transfer until the SSZ pin is pulled high. A multiple-byte data write or read transfer is identical to a single-byte data write or read transfer, respectively, until all data byte transfers complete. The host device must keep the SSZ pin low during all data byte transfers. 図 7-71 shows the single-byte write transfer and 図 7-72 shows the single-byte read transfer.

表 7-52. SPI Command Word

| BIT 7 | BIT 6 | BIT 5 | BIT 4 | BIT 3 | BIT 2 | BIT 1 | BIT 0 |
|---------|---------|---------|---------|---------|---------|---------|-------|
| ADDR(6) | ADDR(5) | ADDR(4) | ADDR(3) | ADDR(2) | ADDR(1) | ADDR(0) | R/WZ |



図 7-71. SPI Single-Byte Write Transfer



図 7-72. SPI Single-Byte Read Transfer

7.6 Register Maps

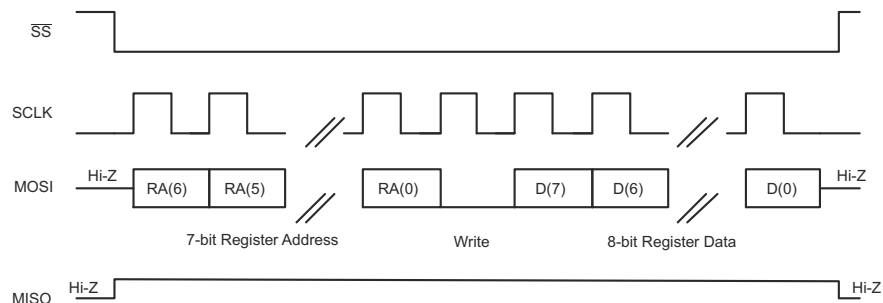
This section describes the control registers for the device in detail. All these registers are eight bits in width and allocated to device configuration and programmable coefficients settings. These registers are mapped internally using a page scheme that can be controlled using either I²C or SPI communication to the device. Each page contains 128 bytes of registers. All device configuration registers are stored in page 0, which is the default page setting at power up (and after a software reset). All programmable coefficient registers are located in page 2, page 3, and page 4. The device current page can be switched to a new desired page by using the PAGE[7:0] bits located in register 0 of every page.

Do not read from or write to reserved pages or reserved registers. Write only default values for the reserved bits in the valid registers.

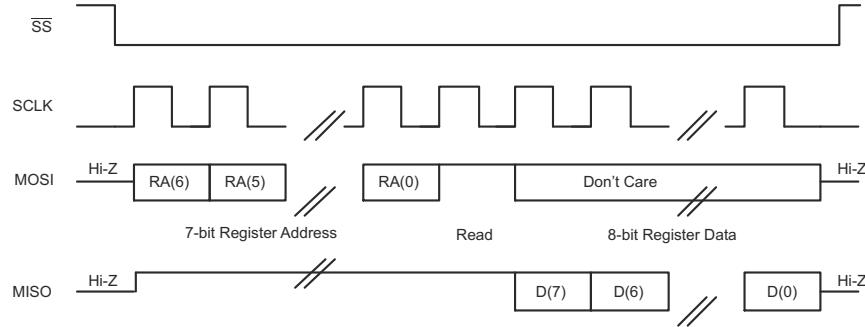
The procedure for register access across pages is:

- Select page N (write data N to register 0 regardless of the current page number)
- Read or write data from or to valid registers in page N
- Select the new page M (write data M to register 0 regardless of the current page number)
- Read or write data from or to valid registers in page M
- Repeat as needed

7.6.1 Device Configuration Registers

This section describes the device configuration registers for page 0.

表 7-53. Register Summary Table, Page = 0x00

| ADDRESS | REGISTER | DESCRIPTION | SECTION |
|---------|-----------|---|------------------|
| 0x00 | PAGE_CFG | Device page register | セクション 7.6.1.1.1 |
| 0x01 | SW_RESET | Software reset register | セクション 7.6.1.1.2 |
| 0x02 | SLEEP_CFG | Sleep mode register | セクション 7.6.1.1.3 |
| 0x05 | SHDN_CFG | Shutdown configuration register | セクション 7.6.1.1.4 |
| 0x07 | ASI_CFG0 | ASI configuration register 0 | セクション 7.6.1.1.5 |
| 0x08 | ASI_CFG1 | ASI configuration register 1 | セクション 7.6.1.1.6 |
| 0x09 | ASI_CFG2 | ASI configuration register 2 | セクション 7.6.1.1.7 |
| 0x0B | ASI_CH1 | Channel 1 ASI slot configuration register | セクション 7.6.1.1.8 |
| 0x0C | ASI_CH2 | Channel 2 ASI slot configuration register | セクション 7.6.1.1.9 |
| 0x0D | ASI_CH3 | Channel 3 ASI slot configuration register | セクション 7.6.1.1.10 |
| 0x0E | ASI_CH4 | Channel 4 ASI slot configuration register | セクション 7.6.1.1.11 |
| 0x0F | ASI_CH5 | Channel 5 ASI slot configuration register | セクション 7.6.1.1.12 |

表 7-53. Register Summary Table, Page = 0x00 (続き)

| ADDRESS | REGISTER | DESCRIPTION | SECTION |
|---------|------------|---|----------------------------------|
| 0x10 | ASI_CH6 | Channel 6 ASI slot configuration register | セクション 7.6.1.1.13 |
| 0x11 | ASI_CH7 | Channel 7 ASI slot configuration register | セクション 7.6.1.1.14 |
| 0x12 | ASI_CH8 | Channel 8 ASI slot configuration register | セクション 7.6.1.1.15 |
| 0x13 | MST_CFG0 | ASI master mode configuration register 0 | セクション 7.6.1.1.16 |
| 0x14 | MST_CFG1 | ASI master mode configuration register 1 | セクション 7.6.1.1.17 |
| 0x15 | ASI_STS | ASI bus clock monitor status register | セクション 7.6.1.1.18 |
| 0x16 | CLK_SRC | Clock source configuration register 0 | セクション 7.6.1.1.19 |
| 0x1F | PDMCLK_CFG | PDM clock generation configuration register | セクション 7.6.1.1.20 |
| 0x20 | PDMIN_CFG | PDM DINx sampling edge register | セクション 7.6.1.1.21 |
| 0x21 | GPIO_CFG0 | GPIO configuration register 0 | セクション 7.6.1.1.22 |
| 0x22 | GPO_CFG0 | GPO configuration register 0 | セクション 7.6.1.1.23 |
| 0x23 | GPO_CFG1 | GPO configuration register 1 | セクション 7.6.1.1.24 |
| 0x24 | GPO_CFG2 | GPO configuration register 2 | セクション 7.6.1.1.25 |
| 0x25 | GPO_CFG3 | GPO configuration register 3 | セクション 7.6.1.1.26 |
| 0x29 | GPO_VAL | GPIO, GPO output value register | セクション 7.6.1.1.27 |
| 0x2A | GPIO_MON | GPIO monitor value register | セクション 7.6.1.1.28 |
| 0x2B | GPI_CFG0 | GPI configuration register 0 | セクション 7.6.1.1.29 |
| 0x2C | GPI_CFG1 | GPI configuration register 1 | セクション 7.6.1.1.30 |
| 0x2F | GPI_MON | GPI monitor value register | セクション 7.6.1.1.31 |
| 0x32 | INT_CFG | Interrupt configuration register | セクション 7.6.1.1.32 |
| 0x33 | INT_MASK0 | Interrupt mask register 0 | セクション 7.6.1.1.33 |
| 0x36 | INT_LTCH0 | Latched interrupt readback register 0 | セクション 7.6.1.1.34 |
| 0x3B | BIAS_CFG | Bias and ADC configuration register | セクション 7.6.1.1.35 |
| 0x3C | CH1_CFG0 | Channel 1 configuration register 0 | セクション 7.6.1.1.36 |
| 0x3D | CH1_CFG1 | Channel 1 configuration register 1 | セクション 7.6.1.1.37 |
| 0x3E | CH1_CFG2 | Channel 1 configuration register 2 | セクション 7.6.1.1.38 |
| 0x3F | CH1_CFG3 | Channel 1 configuration register 3 | セクション 7.6.1.1.39 |
| 0x40 | CH1_CFG4 | Channel 1 configuration register 4 | セクション 7.6.1.1.40 |
| 0x41 | CH2_CFG0 | Channel 2 configuration register 0 | セクション 7.6.1.1.41 |
| 0x42 | CH2_CFG1 | Channel 2 configuration register 1 | セクション 7.6.1.1.42 |
| 0x43 | CH2_CFG2 | Channel 2 configuration register 2 | セクション 7.6.1.1.43 |
| 0x44 | CH2_CFG3 | Channel 2 configuration register 3 | セクション 7.6.1.1.44 |
| 0x45 | CH2_CFG4 | Channel 2 configuration register 4 | セクション 7.6.1.1.45 |
| 0x46 | CH3_CFG0 | Channel 3 configuration register 0 | セクション 7.6.1.1.46 |
| 0x47 | CH3_CFG1 | Channel 3 configuration register 1 | セクション 7.6.1.1.47 |
| 0x48 | CH3_CFG2 | Channel 3 configuration register 2 | セクション 7.6.1.1.48 |

表 7-53. Register Summary Table, Page = 0x00 (続き)

| ADDRESS | REGISTER | DESCRIPTION | SECTION |
|---------|---------------|--|----------------------------------|
| 0x49 | CH3_CFG3 | Channel 3 configuration register 3 | セクション 7.6.1.1.49 |
| 0x4A | CH3_CFG4 | Channel 3 configuration register 4 | セクション 7.6.1.1.50 |
| 0x4B | CH4_CFG0 | Channel 4 configuration register 0 | セクション 7.6.1.1.51 |
| 0x4C | CH4_CFG1 | Channel 4 configuration register 1 | セクション 7.6.1.1.52 |
| 0x4D | CH4_CFG2 | Channel 4 configuration register 2 | セクション 7.6.1.1.53 |
| 0x4E | CH4_CFG3 | Channel 4 configuration register 3 | セクション 7.6.1.1.54 |
| 0x4F | CH4_CFG4 | Channel 4 configuration register 4 | セクション 7.6.1.1.55 |
| 0x52 | CH5_CFG2 | Channel 5 (PDM only) configuration register 2 | セクション 7.6.1.1.56 |
| 0x53 | CH5_CFG3 | Channel 5 (PDM only) configuration register 3 | セクション 7.6.1.1.57 |
| 0x54 | CH5_CFG4 | Channel 5 (PDM only) configuration register 4 | セクション 7.6.1.1.58 |
| 0x57 | CH6_CFG2 | Channel 6 (PDM only) configuration register 2 | セクション 7.6.1.1.59 |
| 0x58 | CH6_CFG3 | Channel 6 (PDM only) configuration register 3 | セクション 7.6.1.1.60 |
| 0x59 | CH6_CFG4 | Channel 6 (PDM only) configuration register 4 | セクション 7.6.1.1.61 |
| 0x5C | CH7_CFG2 | Channel 7 (PDM only) configuration register 2 | セクション 7.6.1.1.62 |
| 0x5D | CH7_CFG3 | Channel 7 (PDM only) configuration register 3 | セクション 7.6.1.1.63 |
| 0x5E | CH7_CFG4 | Channel 7 (PDM only) configuration register 4 | セクション 7.6.1.1.64 |
| 0x61 | CH8_CFG2 | Channel 8 (PDM only) configuration register 2 | セクション 7.6.1.1.65 |
| 0x62 | CH8_CFG3 | Channel 8 (PDM only) configuration register 3 | セクション 7.6.1.1.66 |
| 0x63 | CH8_CFG4 | Channel 8 (PDM only) configuration register 4 | セクション 7.6.1.1.67 |
| 0x6B | DSP_CFG0 | DSP configuration register 0 | セクション 7.6.1.1.68 |
| 0x6C | DSP_CFG1 | DSP configuration register 1 | セクション 7.6.1.1.69 |
| 0x6D | DRE_CFG0 | DRE configuration register 0 | セクション 7.6.1.1.70 |
| 0x70 | AGC_CFG0 | AGC configuration register 0 | セクション 7.6.1.1.71 |
| 0x73 | IN_CH_EN | Input channel enable configuration register | セクション 7.6.1.1.72 |
| 0x74 | ASI_OUT_CH_EN | ASI output channel enable configuration register | セクション 7.6.1.1.73 |
| 0x75 | PWR_CFG | Power up configuration register | セクション 7.6.1.1.74 |
| 0x76 | DEV_STS0 | Device status value register 0 | セクション 7.6.1.1.75 |
| 0x77 | DEV_STS1 | Device status value register 1 | セクション 7.6.1.1.76 |
| 0x7E | I2C_CKSUM | I ² C checksum register | セクション 7.6.1.1.77 |

表 7-54 lists the access codes used for the PCM5140-Q1 registers.

表 7-54. PCM5140-Q1 Access Type Codes

| Access Type | Code | Description |
|-------------|------|---------------|
| Read Type | | |
| R | R | Read |
| R-W | R/W | Read or write |
| Write Type | | |
| W | W | Write |

表 7-54. PCM5140-Q1 Access Type Codes (続き)

| Access Type | Code | Description |
|------------------------|------|--|
| Reset or Default Value | | |
| -n | | Value after reset or the default value |

7.6.1.1 Register Descriptions

7.6.1.1.1 PAGE_CFG Register (page = 0x00, address = 0x00) [reset = 0h]

The device memory map is divided into pages. This register sets the page.

図 7-73. PAGE_CFG Register

| 7 | 6 | 5 | 4 | 3 | 2 | 1 | 0 |
|-----------|---|---|---|---|---|---|---|
| PAGE[7:0] | | | | | | | |
| R/W-0h | | | | | | | |

表 7-55. PAGE_CFG Register Field Descriptions

| Bit | Field | Type | Reset | Description |
|-----|-----------|------|-------|---|
| 7-0 | PAGE[7:0] | R/W | 0h | These bits set the device page. 0d = Page 0 1d = Page 1 ... 255d = Page 255 |

7.6.1.1.2 SW_RESET Register (page = 0x00, address = 0x01) [reset = 0h]

This register is the software reset register. Asserting a software reset places all register values in their default power-on-reset (POR) state.

図 7-74. SW_RESET Register

| 7 | 6 | 5 | 4 | 3 | 2 | 1 | 0 |
|----------|---|---|---|---|---|---|----------|
| Reserved | | | | | | | SW_RESET |
| R-0h | | | | | | | R/W-0h |

表 7-56. SW_RESET Register Field Descriptions

| Bit | Field | Type | Reset | Description |
|-----|----------|------|-------|---|
| 7-1 | Reserved | R | 0h | Reserved |
| 0 | SW_RESET | R/W | 0h | Software reset. This bit is self clearing. 0d = Do not reset 1d = Reset |

7.6.1.1.3 SLEEP_CFG Register (page = 0x00, address = 0x02) [reset = 0h]

This register configures the regulator, VREF quick charge, I²C broadcast, and sleep mode.

図 7-75. SLEEP_CFG Register

| 7 | 6 | 5 | 4 | 3 | 2 | 1 | 0 |
|-------------|----------|---|----------------|---|----------------|----------|-----------|
| AREG_SELECT | Reserved | | VREF_QCHG[1:0] | | I2C_BRDCAST_EN | Reserved | SLEEP_ENZ |
| R/W-0h | R/W-0h | | R/W-0h | | R/W-0h | R-0h | R/W-0h |

表 7-57. SLEEP_CFG Register Field Descriptions

| Bit | Field | Type | Reset | Description |
|-----|----------------|------|-------|--|
| 7 | AREG_SELECT | R/W | 0h | The analog supply selection from either the internal regulator supply or the external AREG supply. 0d = External 1.8-V AREG supply (use this setting when AVDD is 1.8 V and short AREG with AVDD) 1d = Internally generated 1.8-V AREG supply using an on-chip regulator (use this setting when AVDD is 3.3 V) |
| 6-5 | Reserved | R/W | 0h | Reserved |
| 4-3 | VREF_QCHG[1:0] | R/W | 0h | The duration of the quick-charge for the VREF external capacitor is set using an internal series impedance of 200 Ω. 0d = VREF quick-charge duration of 3.5 ms (typical) 1d = VREF quick-charge duration of 10 ms (typical) 2d = VREF quick-charge duration of 50 ms (typical) 3d = VREF quick-charge duration of 100 ms (typical) |
| 2 | I2C_BRDCAST_EN | R/W | 0h | I ² C broadcast addressing setting. 0d = I ² C broadcast mode disabled; the I ² C target address is determined based on the ADDR pins 1d = I ² C broadcast mode enabled; the I ² C target address is fixed at 1001 100 |
| 1 | Reserved | R | 0h | Reserved |
| 0 | SLEEP_ENZ | R/W | 0h | Sleep mode setting. 0d = Device is in sleep mode 1d = Device is not in sleep mode |

7.6.1.1.4 SHDN_CFG Register (page = 0x00, address = 0x05) [reset = 5h]

This register configures the device shutdown.

図 7-76. SHDN_CFG Register

| 7 | 6 | 5 | 4 | 3 | 2 | 1 | 0 |
|----------|---|-----------------|---|----------------|---|-------------------|---|
| Reserved | | INCAP_QCHG[1:0] | | SHDNZ_CFG[1:0] | | DREG_KA_TIME[1:0] | |
| R-0h | | R/W-0h | | R/W-1h | | R/W-1h | |

表 7-58. SHDN_CFG Register Field Descriptions

| Bit | Field | Type | Reset | Description |
|-----|-------------------|------|-------|--|
| 7-6 | Reserved | R | 0h | Reserved |
| 5-4 | INCAP_QCHG[1:0] | R/W | 0h | The duration of the quick-charge for the external AC-coupling capacitor is set using an internal series impedance of 800 Ω. 0d = INxP, INxM quick-charge duration of 2.5 ms (typical) 1d = INxP, INxM quick-charge duration of 12.5 ms (typical) 2d = INxP, INxM quick-charge duration of 25 ms (typical) 3d = INxP, INxM quick-charge duration of 50 ms (typical) |
| 3-2 | SHDNZ_CFG[1:0] | R/W | 1h | Shutdown configuration. 0d = DREG is powered down immediately after SHDNZ asserts 1d = DREG remains active to enable a clean shut down until a time-out is reached; after the time-out period, DREG is forced to power off 2d = DREG remains active until the device cleanly shuts down 3d = Reserved |
| 1-0 | DREG_KA_TIME[1:0] | R/W | 1h | These bits set how long DREG remains active after SHDNZ asserts. 0d = DREG remains active for 30 ms (typical) 1d = DREG remains active for 25 ms (typical) 2d = DREG remains active for 10 ms (typical) 3d = DREG remains active for 5 ms (typical) |

7.6.1.1.5 ASI_CFG0 Register (page = 0x00, address = 0x07) [reset = 30h]

This register is the ASI configuration register 0.

 7-77. ASI_CFG0 Register

| 7 | 6 | 5 | 4 | 3 | 2 | 1 | 0 |
|-----------------|---|---------------|---|-----------|----------|---------|---------|
| ASI_FORMAT[1:0] | | ASI_WLEN[1:0] | | FSYNC_POL | BCLK_POL | TX_EDGE | TX_FILL |
| R/W-0h | | R/W-3h | | R/W-0h | R/W-0h | R/W-0h | R/W-0h |

表 7-59. ASI_CFG0 Register Field Descriptions

| Bit | Field | Type | Reset | Description |
|-----|-----------------|------|-------|---|
| 7-6 | ASI_FORMAT[1:0] | R/W | 0h | ASI protocol format. 0d = TDM mode 1d = I ² S mode 2d = LJ (left-justified) mode 3d = Reserved |
| 5-4 | ASI_WLEN[1:0] | R/W | 3h | ASI word or slot length. 0d = 16 bits 1d = 20 bits 2d = 24 bits 3d = 32 bits |
| 3 | FSYNC_POL | R/W | 0h | ASI FSYNC polarity. 0d = Default polarity as per standard protocol 1d = Inverted polarity with respect to standard protocol |
| 2 | BCLK_POL | R/W | 0h | ASI BCLK polarity. 0d = Default polarity as per standard protocol 1d = Inverted polarity with respect to standard protocol |
| 1 | TX_EDGE | R/W | 0h | ASI data output (on the primary and secondary data pin) transmit edge. 0d = Default edge as per the protocol configuration setting in bit 2 (BCLK_POL) 1d = Inverted following edge (half cycle delay) with respect to the default edge setting |
| 0 | TX_FILL | R/W | 0h | ASI data output (on the primary and secondary data pin) for any unused cycles 0d = Always transmit 0 for unused cycles 1d = Always use Hi-Z for unused cycles |

7.6.1.1.6 ASI_CFG1 Register (page = 0x00, address = 0x08) [reset = 0h]

This register is the ASI configuration register 1.

 7-78. ASI_CFG1 Register

| 7 | 6 | 5 | 4 | 3 | 2 | 1 | 0 |
|--------|----------------|---|----------------|---|---|---|---|
| TX_LSB | TX_KEEPER[1:0] | | TX_OFFSET[4:0] | | | | |
| R/W-0h | R/W-0h | | R/W-0h | | | | |

表 7-60. ASI_CFG1 Register Field Descriptions

| Bit | Field | Type | Reset | Description |
|-----|----------------|------|-------|--|
| 7 | TX_LSB | R/W | 0h | ASI data output (on the primary and secondary data pin) for LSB transmissions. 0d = Transmit the LSB for a full cycle 1d = Transmit the LSB for the first half cycle and Hi-Z for the second half cycle |
| 6-5 | TX_KEEPER[1:0] | R/W | 0h | ASI data output (on the primary and secondary data pin) bus keeper. 0d = Bus keeper is always disabled 1d = Bus keeper is always enabled 2d = Bus keeper is enabled during LSB transmissions only for one cycle 3d = Bus keeper is enabled during LSB transmissions only for one and half cycles |

表 7-60. ASI_CFG1 Register Field Descriptions (続き)

| Bit | Field | Type | Reset | Description |
|-----|----------------|------|-------|--|
| 4-0 | TX_OFFSET[4:0] | R/W | 0h | ASI data MSB slot 0 offset (on the primary and secondary data pin). 0d = ASI data MSB location has no offset and is as per standard protocol 1d = ASI data MSB location (TDM mode is slot 0 or I ² S, LJ mode is the left and right slot 0) offset of one BCLK cycle with respect to standard protocol 2d = ASI data MSB location (TDM mode is slot 0 or I ² S, LJ mode is the left and right slot 0) offset of two BCLK cycles with respect to standard protocol 3d to 30d = ASI data MSB location (TDM mode is slot 0 or I ² S, LJ mode is the left and right slot 0) offset assigned as per configuration 31d = ASI data MSB location (TDM mode is slot 0 or I ² S, LJ mode is the left and right slot 0) offset of 31 BCLK cycles with respect to standard protocol |

7.6.1.1.7 ASI_CFG2 Register (page = 0x00, address = 0x09) [reset = 0h]

This register is the ASI configuration register 2.

図 7-79. ASI_CFG2 Register

| 7 | 6 | 5 | 4 | 3 | 2 | 1 | 0 |
|------------|----------|---------|--------------|----------|---|---|---|
| ASI_DAISSY | Reserved | ASI_ERR | ASI_ERR_RCOV | Reserved | | | |
| R/W-0h | R-0h | R/W-0h | R/W-0h | R-0h | | | |

表 7-61. ASI_CFG2 Register Field Descriptions

| Bit | Field | Type | Reset | Description |
|-----|--------------|------|-------|--|
| 7 | ASI_DAISSY | R/W | 0h | ASI daisy-chain connection. 0d = All devices are connected in the common ASI bus 1d = All devices are daisy-chained for the ASI bus |
| 6 | Reserved | R | 0h | Reserved |
| 5 | ASI_ERR | R/W | 0h | ASI bus error detection. 0d = Enable bus error detection 1d = Disable bus error detection |
| 4 | ASI_ERR_RCOV | R/W | 0h | ASI bus error auto resume. 0d = Enable auto resume after bus error recovery 1d = Disable auto resume after bus error recovery and remain powered down until the host configures the device |
| 3-0 | Reserved | R | 0h | Reserved |

7.6.1.1.8 ASI_CH1 Register (page = 0x00, address = 0x0B) [reset = 0h]

This register is the ASI slot configuration register for channel 1.

図 7-80. ASI_CH1 Register

| 7 | 6 | 5 | 4 | 3 | 2 | 1 | 0 |
|----------|------------|---------------|---|---|---|---|---|
| Reserved | CH1_OUTPUT | CH1_SLOT[5:0] | | | | | |
| R-0h | R/W-0h | R/W-0h | | | | | |

表 7-62. ASI_CH1 Register Field Descriptions

| Bit | Field | Type | Reset | Description |
|-----|------------|------|-------|--|
| 7 | Reserved | R | 0h | Reserved |
| 6 | CH1_OUTPUT | R/W | 0h | Channel 1 output line. 0d = Channel 1 output is on the ASI primary output pin (SDOUT) 1d = Channel 1 output is on the ASI secondary output pin (GPIO1 or GPOx) |

表 7-62. ASI_CH1 Register Field Descriptions (続き)

| Bit | Field | Type | Reset | Description |
|-----|---------------|------|-------|--|
| 5-0 | CH1_SLOT[5:0] | R/W | 0h | Channel 1 slot assignment. 0d = TDM is slot 0 or I ² S, LJ is left slot 0 1d = TDM is slot 1 or I ² S, LJ is left slot 1 2d to 30d = Slot assigned as per configuration 31d = TDM is slot 31 or I ² S, LJ is left slot 31 32d = TDM is slot 32 or I ² S, LJ is right slot 0 33d = TDM is slot 33 or I ² S, LJ is right slot 1 34d to 62d = Slot assigned as per configuration 63d = TDM is slot 63 or I ² S, LJ is right slot 31 |

7.6.1.1.9 ASI_CH2 Register (page = 0x00, address = 0x0C) [reset = 1h]

This register is the ASI slot configuration register for channel 2.

図 7-81. ASI_CH2 Register

| 7 | 6 | 5 | 4 | 3 | 2 | 1 | 0 |
|----------|------------|---------------|---|---|---|---|---|
| Reserved | CH2_OUTPUT | CH2_SLOT[5:0] | | | | | |
| R-0h | R/W-0h | R/W-1h | | | | | |

表 7-63. ASI_CH2 Register Field Descriptions

| Bit | Field | Type | Reset | Description |
|-----|---------------|------|-------|--|
| 7 | Reserved | R | 0h | Reserved |
| 6 | CH2_OUTPUT | R/W | 0h | Channel 2 output line. 0d = Channel 2 output is on the ASI primary output pin (SDOUT) 1d = Channel 2 output is on the ASI secondary output pin (GPIO1 or GPOx) |
| 5-0 | CH2_SLOT[5:0] | R/W | 1h | Channel 2 slot assignment. 0d = TDM is slot 0 or I ² S, LJ is left slot 0 1d = TDM is slot 1 or I ² S, LJ is left slot 1 2d to 30d = Slot assigned as per configuration 31d = TDM is slot 31 or I ² S, LJ is left slot 31 32d = TDM is slot 32 or I ² S, LJ is right slot 0 33d = TDM is slot 33 or I ² S, LJ is right slot 1 34d to 62d = Slot assigned as per configuration 63d = TDM is slot 63 or I ² S, LJ is right slot 31 |

7.6.1.1.10 ASI_CH3 Register (page = 0x00, address = 0x0D) [reset = 2h]

This register is the ASI slot configuration register for channel 3.

図 7-82. ASI_CH3 Register

| 7 | 6 | 5 | 4 | 3 | 2 | 1 | 0 |
|----------|------------|---------------|---|---|---|---|---|
| Reserved | CH3_OUTPUT | CH3_SLOT[5:0] | | | | | |
| R-0h | R/W-0h | R/W-2h | | | | | |

表 7-64. ASI_CH3 Register Field Descriptions

| Bit | Field | Type | Reset | Description |
|-----|------------|------|-------|--|
| 7 | Reserved | R | 0h | Reserved |
| 6 | CH3_OUTPUT | R/W | 0h | Channel 3 output line. 0d = Channel 3 output is on the ASI primary output pin (SDOUT) 1d = Channel 3 output is on the ASI secondary output pin (GPIO1 or GPOx) |

表 7-64. ASI_CH3 Register Field Descriptions (続き)

| Bit | Field | Type | Reset | Description |
|-----|---------------|------|-------|--|
| 5-0 | CH3_SLOT[5:0] | R/W | 2h | Channel 3 slot assignment. 0d = TDM is slot 0 or I ² S, LJ is left slot 0 1d = TDM is slot 1 or I ² S, LJ is left slot 1 2d to 30d = Slot assigned as per configuration 31d = TDM is slot 31 or I ² S, LJ is left slot 31 32d = TDM is slot 32 or I ² S, LJ is right slot 0 33d = TDM is slot 33 or I ² S, LJ is right slot 1 34d to 62d = Slot assigned as per configuration 63d = TDM is slot 63 or I ² S, LJ is right slot 31 |

7.6.1.1.11 ASI_CH4 Register (page = 0x00, address = 0x0E) [reset = 3h]

This register is the ASI slot configuration register for channel 4.

図 7-83. ASI_CH4 Register

| 7 | 6 | 5 | 4 | 3 | 2 | 1 | 0 |
|----------|------------|---------------|---|---|---|---|---|
| Reserved | CH4_OUTPUT | CH4_SLOT[5:0] | | | | | |
| R-0h | R/W-0h | R/W-3h | | | | | |

表 7-65. ASI_CH4 Register Field Descriptions

| Bit | Field | Type | Reset | Description |
|-----|---------------|------|-------|--|
| 7 | Reserved | R | 0h | Reserved |
| 6 | CH4_OUTPUT | R/W | 0h | Channel 4 output line. 0d = Channel 4 output is on the ASI primary output pin (SDOUT) 1d = Channel 4 output is on the ASI secondary output pin (GPIO1 or GPOx) |
| 5-0 | CH4_SLOT[5:0] | R/W | 3h | Channel 4 slot assignment. 0d = TDM is slot 0 or I ² S, LJ is left slot 0 1d = TDM is slot 1 or I ² S, LJ is left slot 1 2d to 30d = Slot assigned as per configuration 31d = TDM is slot 31 or I ² S, LJ is left slot 31 32d = TDM is slot 32 or I ² S, LJ is right slot 0 33d = TDM is slot 33 or I ² S, LJ is right slot 1 34d to 62d = Slot assigned as per configuration 63d = TDM is slot 63 or I ² S, LJ is right slot 31 |

7.6.1.1.12 ASI_CH5 Register (page = 0x00, address = 0x0F) [reset = 4h]

This register is the ASI slot configuration register for channel 5.

図 7-84. ASI_CH5 Register

| 7 | 6 | 5 | 4 | 3 | 2 | 1 | 0 |
|----------|------------|---------------|---|---|---|---|---|
| Reserved | CH5_OUTPUT | CH5_SLOT[5:0] | | | | | |
| R-0h | R/W-0h | R/W-4h | | | | | |

表 7-66. ASI_CH5 Register Field Descriptions

| Bit | Field | Type | Reset | Description |
|-----|------------|------|-------|--|
| 7 | Reserved | R | 0h | Reserved |
| 6 | CH5_OUTPUT | R/W | 0h | Channel 5 output line. 0d = Channel 5 output is on the ASI primary output pin (SDOUT) 1d = Channel 5 output is on the ASI secondary output pin (GPIO1 or GPOx) |

表 7-66. ASI_CH5 Register Field Descriptions (続き)

| Bit | Field | Type | Reset | Description |
|-----|---------------|------|-------|--|
| 5-0 | CH5_SLOT[5:0] | R/W | 4h | Channel 5 slot assignment. 0d = TDM is slot 0 or I ² S, LJ is left slot 0 1d = TDM is slot 1 or I ² S, LJ is left slot 1 2d to 30d = Slot assigned as per configuration 31d = TDM is slot 31 or I ² S, LJ is left slot 31 32d = TDM is slot 32 or I ² S, LJ is right slot 0 33d = TDM is slot 33 or I ² S, LJ is right slot 1 34d to 62d = Slot assigned as per configuration 63d = TDM is slot 63 or I ² S, LJ is right slot 31 |

7.6.1.1.13 ASI_CH6 Register (page = 0x00, address = 0x10) [reset = 5h]

This register is the ASI slot configuration register for channel 6.

図 7-85. ASI_CH6 Register

| 7 | 6 | 5 | 4 | 3 | 2 | 1 | 0 |
|----------|------------|---------------|---|---|---|---|---|
| Reserved | CH6_OUTPUT | CH6_SLOT[5:0] | | | | | |
| R-0h | R/W-0h | R/W-5h | | | | | |

表 7-67. ASI_CH6 Register Field Descriptions

| Bit | Field | Type | Reset | Description |
|-----|---------------|------|-------|--|
| 7 | Reserved | R | 0h | Reserved |
| 6 | CH6_OUTPUT | R/W | 0h | Channel 6 output line. 0d = Channel 6 output is on the ASI primary output pin (SDOUT) 1d = Channel 6 output is on the ASI secondary output pin (GPIO1 or GPOx) |
| 5-0 | CH6_SLOT[5:0] | R/W | 5h | Channel 6 slot assignment. 0d = TDM is slot 0 or I ² S, LJ is left slot 0 1d = TDM is slot 1 or I ² S, LJ is left slot 1 2d to 30d = Slot assigned as per configuration 31d = TDM is slot 31 or I ² S, LJ is left slot 31 32d = TDM is slot 32 or I ² S, LJ is right slot 0 33d = TDM is slot 33 or I ² S, LJ is right slot 1 34d to 62d = Slot assigned as per configuration 63d = TDM is slot 63 or I ² S, LJ is right slot 31 |

7.6.1.1.14 ASI_CH7 Register (page = 0x00, address = 0x11) [reset = 6h]

This register is the ASI slot configuration register for channel 7.

図 7-86. ASI_CH7 Register

| 7 | 6 | 5 | 4 | 3 | 2 | 1 | 0 |
|----------|------------|---------------|---|---|---|---|---|
| Reserved | CH7_OUTPUT | CH7_SLOT[5:0] | | | | | |
| R-0h | R/W-0h | R/W-6h | | | | | |

表 7-68. ASI_CH7 Register Field Descriptions

| Bit | Field | Type | Reset | Description |
|-----|------------|------|-------|--|
| 7 | Reserved | R | 0h | Reserved |
| 6 | CH7_OUTPUT | R/W | 0h | Channel 7 output line. 0d = Channel 7 output is on the ASI primary output pin (SDOUT) 1d = Channel 7 output is on the ASI secondary output pin (GPIO1 or GPOx) |

表 7-68. ASI_CH7 Register Field Descriptions (続き)

| Bit | Field | Type | Reset | Description |
|-----|---------------|------|-------|--|
| 5-0 | CH7_SLOT[5:0] | R/W | 6h | Channel 7 slot assignment. 0d = TDM is slot 0 or I ² S, LJ is left slot 0 1d = TDM is slot 1 or I ² S, LJ is left slot 1 2d to 30d = Slot assigned as per configuration 31d = TDM is slot 31 or I ² S, LJ is left slot 31 32d = TDM is slot 32 or I ² S, LJ is right slot 0 33d = TDM is slot 33 or I ² S, LJ is right slot 1 34d to 62d = Slot assigned as per configuration 63d = TDM is slot 63 or I ² S, LJ is right slot 31 |

7.6.1.1.15 ASI_CH8 Register (page = 0x00, address = 0x12) [reset = 7h]

This register is the ASI slot configuration register for channel 8.

図 7-87. ASI_CH8 Register

| 7 | 6 | 5 | 4 | 3 | 2 | 1 | 0 |
|----------|------------|---------------|---|---|---|---|---|
| Reserved | CH8_OUTPUT | CH8_SLOT[5:0] | | | | | |
| R-0h | R/W-0h | R/W-7h | | | | | |

表 7-69. ASI_CH8 Register Field Descriptions

| Bit | Field | Type | Reset | Description |
|-----|---------------|------|-------|--|
| 7 | Reserved | R | 0h | Reserved |
| 6 | CH8_OUTPUT | R/W | 0h | Channel 8 output line. 0d = Channel 8 output is on the ASI primary output pin (SDOUT) 1d = Channel 8 output is on the ASI secondary output pin (GPIO1 or GPOx) |
| 5-0 | CH8_SLOT[5:0] | R/W | 7h | Channel 8 slot assignment. 0d = TDM is slot 0 or I ² S, LJ is left slot 0 1d = TDM is slot 1 or I ² S, LJ is left slot 1 2d to 30d = Slot assigned as per configuration 31d = TDM is slot 31 or I ² S, LJ is left slot 31 32d = TDM is slot 32 or I ² S, LJ is right slot 0 33d = TDM is slot 33 or I ² S, LJ is right slot 1 34d to 62d = Slot assigned as per configuration 63d = TDM is slot 63 or I ² S, LJ is right slot 31 |

7.6.1.1.16 MST_CFG0 Register (page = 0x00, address = 0x13) [reset = 2h]

This register is the ASI controller mode configuration register 0.

図 7-88. MST_CFG0 Register

| 7 | 6 | 5 | 4 | 3 | 2 | 1 | 0 |
|-------------|--------------|-------------------|-----------------|---------|--------------------|---|---|
| MST_SLV_CFG | AUTO_CLK_CFG | AUTO_MODE_PLL_DIS | BCLK_FSYNC_GATE | FS_MODE | MCLK_FREQ_SEL[2:0] | | |
| R/W-0h | R/W-0h | R/W-0h | R/W-0h | R/W-0h | R/W-2h | | |

表 7-70. MST_CFG0 Register Field Descriptions

| Bit | Field | Type | Reset | Description |
|-----|--------------|------|-------|--|
| 7 | MST_SLV_CFG | R/W | 0h | ASI controller or slave configuration register setting. 0d = Device is in slave mode (both BCLK and FSYNC are inputs to the device) 1d = Device is in controller mode (both BCLK and FSYNC are generated from the device) |
| 6 | AUTO_CLK_CFG | R/W | 0h | Automatic clock configuration setting. 0d = Auto clock configuration is enabled (all internal clock divider and PLL configurations are auto derived) 1d = Auto clock configuration is disabled (custom mode and device GUI must be used for the device configuration settings) |

表 7-70. MST_CFG0 Register Field Descriptions (続き)

| Bit | Field | Type | Reset | Description |
|-----|--------------------|------|-------|---|
| 5 | AUTO_MODE_PLL_DIS | R/W | 0h | Automatic mode PLL setting. 0d = PLL is enabled in auto clock configuration 1d = PLL is disabled in auto clock configuration |
| 4 | BCLK_FSYNC_GATE | R/W | 0h | BCLK and FSYNC clock gate (valid when the device is in controller mode). 0d = Do not gate BCLK and FSYNC 1d = Force gate BCLK and FSYNC when being transmitted from the device in controller mode |
| 3 | FS_MODE | R/W | 0h | Sample rate setting (valid when the device is in controller mode). 0d = f_s is a multiple (or submultiple) of 48 kHz 1d = f_s is a multiple (or submultiple) of 44.1 kHz |
| 2-0 | MCLK_FREQ_SEL[2:0] | R/W | 2h | These bits select the MCLK (GPIO or GPIx) frequency for the PLL source clock input (valid when the device is in controller mode and MCLK_FREQ_SEL_MODE = 0). 0d = 12 MHz 1d = 12.288 MHz 2d = 13 MHz 3d = 16 MHz 4d = 19.2 MHz 5d = 19.68 MHz 6d = 24 MHz 7d = 24.576 MHz |

7.6.1.1.17 MST_CFG1 Register (page = 0x00, address = 0x14) [reset = 48h]

This register is the ASI controller mode configuration register 1.

図 7-89. MST_CFG1 Register

| 7 | 6 | 5 | 4 | 3 | 2 | 1 | 0 |
|--------------|---|---|---|--------------------|---|---|---|
| FS_RATE[3:0] | | | | FS_BCLK_RATIO[3:0] | | | |
| R/W-4h | | | | R/W-8h | | | |

表 7-71. MST_CFG1 Register Field Descriptions

| Bit | Field | Type | Reset | Description |
|-----|--------------|------|-------|---|
| 7-4 | FS_RATE[3:0] | R/W | 4h | Programmed sample rate of the ASI bus (not used when the device is configured in slave mode auto clock configuration). 0d = 7.35 kHz or 8 kHz 1d = 14.7 kHz or 16 kHz 2d = 22.05 kHz or 24 kHz 3d = 29.4 kHz or 32 kHz 4d = 44.1 kHz or 48 kHz 5d = 88.2 kHz or 96 kHz 6d = 176.4 kHz or 192 kHz 7d = 352.8 kHz or 384 kHz 8d = 705.6 kHz or 768 kHz 9d to 15d = Reserved |

表 7-71. MST_CFG1 Register Field Descriptions (続き)

| Bit | Field | Type | Reset | Description |
|-----|--------------------|------|-------|---|
| 3-0 | FS_BCLK_RATIO[3:0] | R/W | 8h | Programmed BCLK to FSYNC frequency ratio of the ASI bus (not used when the device is configured in slave mode auto clock configuration). 0d = Ratio of 16 1d = Ratio of 24 2d = Ratio of 32 3d = Ratio of 48 4d = Ratio of 64 5d = Ratio of 96 6d = Ratio of 128 7d = Ratio of 192 8d = Ratio of 256 9d = Ratio of 384 10d = Ratio of 512 11d = Ratio of 1024 12d = Ratio of 2048 13d to 15d = Reserved |

7.6.1.1.18 ASI_STS Register (page = 0x00, address = 0x15) [reset = FFh]

This register is the ASI bus clock monitor status register.

図 7-90. ASI_STS Register

| 7 | 6 | 5 | 4 | 3 | 2 | 1 | 0 |
|------------------|---|---|---|-------------------|---|---|---|
| FS_RATE_STS[3:0] | | | | FS_RATIO_STS[3:0] | | | |
| R-Fh | | | | R-Fh | | | |

表 7-72. ASI_STS Register Field Descriptions

| Bit | Field | Type | Reset | Description |
|-----|-------------------|------|-------|--|
| 7-4 | FS_RATE_STS[3:0] | R | Fh | Detected sample rate of the ASI bus. 0d = 7.35 kHz or 8 kHz 1d = 14.7 kHz or 16 kHz 2d = 22.05 kHz or 24 kHz 3d = 29.4 kHz or 32 kHz 4d = 44.1 kHz or 48 kHz 5d = 88.2 kHz or 96 kHz 6d = 176.4 kHz or 192 kHz 7d = 352.8 kHz or 384 kHz 8d = 705.6 kHz or 768 kHz 9d to 14d = Reserved 15d = Invalid sample rate |
| 3-0 | FS_RATIO_STS[3:0] | R | Fh | Detected BCLK to FSYNC frequency ratio of the ASI bus. 0d = Ratio of 16 1d = Ratio of 24 2d = Ratio of 32 3d = Ratio of 48 4d = Ratio of 64 5d = Ratio of 96 6d = Ratio of 128 7d = Ratio of 192 8d = Ratio of 256 9d = Ratio of 384 10d = Ratio of 512 11d = Ratio of 1024 12d = Ratio of 2048 13d to 14d = Reserved 15d = Invalid ratio |

7.6.1.1.19 CLK_SRC Register (page = 0x00, address = 0x16) [reset = 10h]

This register is the clock source configuration register.

 **7-91. CLK_SRC Register**

| 7 | 6 | 5 | 4 | 3 | 2 | 1 | 0 |
|---------------------|--------------------|---------------------|---|---|----------|---|---|
| DIS_PLL_SLV_CLK_SRC | MCLK_FREQ_SEL_MODE | MCLK_RATIO_SEL[2:0] | | | Reserved | | |
| R/W-0h | R/W-0h | R/W-2h | | | R-0h | | |

表 7-73. CLK_SRC Register Field Descriptions

| Bit | Field | Type | Reset | Description |
|-----|---------------------|------|-------|---|
| 7 | DIS_PLL_SLV_CLK_SRC | R/W | 0h | Audio root clock source setting when the device is configured with the PLL disabled in the auto clock configuration for slave mode (AUTO_MODE_PLL_DIS = 1). 0d = BCLK is used as the audio root clock source 1d = MCLK (GPIO or GPIx) is used as the audio root clock source (the MCLK to FSYNC ratio is as per the MCLK_RATIO_SEL setting) |
| 6 | MCLK_FREQ_SEL_MODE | R/W | 0h | Controller mode MCLK (GPIO or GPIx) frequency selection mode (valid when the device is in auto clock configuration). 0d = MCLK frequency is based on the MCLK_FREQ_SEL (P0_R19) configuration 1d = MCLK frequency is specified as a multiple of FSYNC in the MCLK_RATIO_SEL (P0_R22) configuration |
| 5-3 | MCLK_RATIO_SEL[2:0] | R/W | 2h | These bits select the MCLK (GPIO or GPIx) to FSYNC ratio for controller mode or when MCLK is used as the audio root clock source in slave mode. 0d = Ratio of 64 1d = Ratio of 256 2d = Ratio of 384 3d = Ratio of 512 4d = Ratio of 768 5d = Ratio of 1024 6d = Ratio of 1536 7d = Ratio of 2304 |
| 2-0 | Reserved | R | 0h | Reserved |

7.6.1.1.20 PDMCLK_CFG Register (page = 0x00, address = 0x1F) [reset = 40h]

This register is the PDM clock generation configuration register.

 **7-92. PDMCLK_CFG Register**

| 7 | 6 | 5 | 4 | 3 | 2 | 1 | 0 |
|----------|---|---|---|---|---|-----------------|---|
| Reserved | | | | | | PDMCLK_DIV[1:0] | |
| R/W-10h | | | | | | R/W-0h | |

表 7-74. PDMCLK_CFG Register Field Descriptions

| Bit | Field | Type | Reset | Description |
|-----|-----------------|------|-------|--|
| 7-2 | Reserved | R/W | 10h | Reserved |
| 1-0 | PDMCLK_DIV[1:0] | R/W | 0h | PDMCLK divider value. 0d = PDMCLK is 2.8224 MHz or 3.072 MHz 1d = PDMCLK is 1.4112 MHz or 1.536 MHz 2d = PDMCLK is 705.6 kHz or 768 kHz 3d = PDMCLK is 5.6448 MHz or 6.144 MHz |

7.6.1.1.21 PDMIN_CFG Register (page = 0x00, address = 0x20) [reset = 0h]

This register is the PDM DINx sampling edge configuration register.

 **7-93. PDMIN_CFG Register**

| 7 | 6 | 5 | 4 | 3 | 2 | 1 | 0 |
|-------------|-------------|-------------|-------------|----------|---|---|---|
| PDMIN1_EDGE | PDMIN2_EDGE | PDMIN3_EDGE | PDMIN4_EDGE | Reserved | | | |

図 7-93. PDMIN_CFG Register (続き)

| | | | | |
|--------|--------|--------|--------|------|
| R/W-0h | R/W-0h | R/W-0h | R/W-0h | R-0h |
|--------|--------|--------|--------|------|

表 7-75. PDMIN_CFG Register Field Descriptions

| Bit | Field | Type | Reset | Description |
|-----|-------------|------|-------|---|
| 7 | PDMIN1_EDGE | R/W | 0h | PDMCLK latching edge used for channel 1 and channel 2 data. 0d = Channel 1 data are latched on the negative edge, channel 2 data are latched on the positive edge 1d = Channel 1 data are latched on the positive edge, channel 2 data are latched on the negative edge |
| 6 | PDMIN2_EDGE | R/W | 0h | PDMCLK latching edge used for channel 3 and channel 4 data. 0d = Channel 3 data are latched on the negative edge, channel 4 data are latched on the positive edge 1d = Channel 3 data are latched on the positive edge, channel 4 data are latched on the negative edge |
| 5 | PDMIN3_EDGE | R/W | 0h | PDMCLK latching edge used for channel 5 and channel 6 data. 0d = Channel 5 data are latched on the negative edge, channel 6 data are latched on the positive edge 1d = Channel 5 data are latched on the positive edge, channel 6 data are latched on the negative edge |
| 4 | PDMIN4_EDGE | R/W | 0h | PDMCLK latching edge used for channel 7 and channel 8 data. 0d = Channel 7 data are latched on the negative edge, channel 8 data are latched on the positive edge 1d = Channel 7 data are latched on the positive edge, channel 8 data are latched on the negative edge |
| 3-0 | Reserved | R | 0h | Reserved |

7.6.1.1.22 GPIO_CFG0 Register (page = 0x00, address = 0x21) [reset = 22h]

This register is the GPIO configuration register 0.

図 7-94. GPIO_CFG0 Register

| | | | | | | | |
|----------------|---|---|---|----------|----------------|---|---|
| 7 | 6 | 5 | 4 | 3 | 2 | 1 | 0 |
| GPIO1_CFG[3:0] | | | | Reserved | GPIO1_DRV[2:0] | | |
| R/W-2h | | | | R-0h | R/W-2h | | |

表 7-76. GPIO_CFG0 Register Field Descriptions

| Bit | Field | Type | Reset | Description |
|-----|----------------|------|-------|--|
| 7-4 | GPIO1_CFG[3:0] | R/W | 2h | GPIO1 configuration. 0d = GPIO1 is disabled 1d = GPIO1 is configured as a general-purpose output (GPO) 2d = GPIO1 is configured as a device interrupt output (IRQ) 3d = GPIO1 is configured as a secondary ASI output (SDOUT2) 4d = GPIO1 is configured as a PDM clock output (PDMCLK) 5d to 7d = Reserved 8d = GPIO1 is configured as an input to control when MICBIAS turns on or off (MICBIAS_EN) 9d = GPIO1 is configured as a general-purpose input (GPI) 10d = GPIO1 is configured as a controller clock input (MCLK) 11d = GPIO1 is configured as an ASI input for daisy-chain (SDIN) 12d = GPIO1 is configured as a PDM data input for channel 1 and channel 2 (PDMIN1) 13d = GPIO1 is configured as a PDM data input for channel 3 and channel 4 (PDMIN2) 14d = GPIO1 is configured as a PDM data input for channel 5 and channel 6 (PDMIN3) 15d = GPIO1 is configured as a PDM data input for channel 7 and channel 8 (PDMIN4) |
| 3 | Reserved | R | 0h | Reserved |

表 7-76. GPIO_CFG0 Register Field Descriptions (続き)

| Bit | Field | Type | Reset | Description |
|-----|----------------|------|-------|--|
| 2-0 | GPIO1_DRV[2:0] | R/W | 2h | GPIO1 output drive configuration (not used when GPIO1 is configured as SDOUT2). 0d = Hi-Z output 1d = Drive active low and active high 2d = Drive active low and weak high 3d = Drive active low and Hi-Z 4d = Drive weak low and active high 5d = Drive Hi-Z and active high 6d to 7d = Reserved |

7.6.1.1.23 GPO_CFG0 Register (page = 0x00, address = 0x22) [reset = 0h]

This register is the GPO configuration register 0.

図 7-95. GPO_CFG0 Register

| 7 | 6 | 5 | 4 | 3 | 2 | 1 | 0 |
|---------------|---|---|---|----------|---|---|----------|
| GPO1_CFG[3:0] | | | | Reserved | | | GPO1_DRV |
| R/W-0h | | | | R-0h | | | R/W-0h |

表 7-77. GPO_CFG0 Register Field Descriptions

| Bit | Field | Type | Reset | Description |
|-----|---------------|------|-------|---|
| 7-4 | GPO1_CFG[3:0] | R/W | 0h | IN1M_GPO1 (GPO1) configuration. 0d = GPO1 is disabled 1d = GPO1 is configured as a general-purpose output (GPO) 2d = GPO1 is configured as a device interrupt output (IRQ) 3d = GPO1 is configured as a secondary ASI output (SDOUT2) 4d = GPO1 is configured as a PDM clock output (PDMCLK) 5d to 15d = Reserved |
| 3-1 | Reserved | R | 0h | Reserved |
| 0 | GPO1_DRV | R/W | 0h | 0d = GPO1 is in a Hi-Z state 1d = GPO1 is driven as Active High/Active Low |

7.6.1.1.24 GPO_CFG1 Register (page = 0x00, address = 0x23) [reset = 0h]

This register is the GPO configuration register 1.

図 7-96. GPO_CFG1 Register

| 7 | 6 | 5 | 4 | 3 | 2 | 1 | 0 |
|---------------|---|---|---|----------|---|---|----------|
| GPO2_CFG[3:0] | | | | Reserved | | | GPO2_DRV |
| R/W-0h | | | | R-0h | | | R/W-0h |

表 7-78. GPO_CFG1 Register Field Descriptions

| Bit | Field | Type | Reset | Description |
|-----|---------------|------|-------|---|
| 7-4 | GPO2_CFG[3:0] | R/W | 0h | IN2M_GPO2 (GPO2) configuration. 0d = GPO2 is disabled 1d = GPO2 is configured as a general-purpose output (GPO) 2d = GPO2 is configured as a device interrupt output (IRQ) 3d = GPO2 is configured as a secondary ASI output (SDOUT2) 4d = GPO2 is configured as a PDM clock output (PDMCLK) 5d to 15d = Reserved |
| 3-1 | Reserved | R | 0h | Reserved |
| 0 | GPO2_DRV | R/W | 0h | 0d = GPO2 is in a Hi-Z state 1d = GPO2 is driven as Active High/Active Low |

7.6.1.1.25 GPO_CFG2 Register (page = 0x00, address = 0x24) [reset = 0h]

This register is the GPO configuration register 2.

図 7-97. GPO_CFG2 Register

| | | | | | | | |
|---------------|---|---|---|----------|---|---|----------|
| 7 | 6 | 5 | 4 | 3 | 2 | 1 | 0 |
| GPO3_CFG[3:0] | | | | Reserved | | | GPO3_DRV |
| R/W-0h | | | | R-0h | | | R/W-0h |

表 7-79. GPO_CFG2 Register Field Descriptions

| Bit | Field | Type | Reset | Description |
|-----|---------------|------|-------|---|
| 7-4 | GPO3_CFG[3:0] | R/W | 0h | IN3M_GPO3 (GPO3) configuration. 0d = GPO3 is disabled 1d = GPO3 is configured as a general-purpose output (GPO) 2d = GPO3 is configured as a device interrupt output (IRQ) 3d = GPO3 is configured as a secondary ASI output (SDOUT2) 4d = GPO3 is configured as a PDM clock output (PDMCLK) 5d to 15d = Reserved |
| 3-1 | Reserved | R | 0h | Reserved |
| 0 | GPO3_DRV | R/W | 0h | 0d = GPO3 is in a Hi-Z state 1d = GPO3 is driven as Active High/Active Low |

7.6.1.1.26 GPO_CFG3 Register (page = 0x00, address = 0x25) [reset = 0h]

This register is the GPO configuration register 3.

図 7-98. GPO_CFG3 Register

| | | | | | | | |
|---------------|---|---|---|----------|---|---|----------|
| 7 | 6 | 5 | 4 | 3 | 2 | 1 | 0 |
| GPO4_CFG[3:0] | | | | Reserved | | | GPO4_DRV |
| R/W-0h | | | | R-0h | | | R/W-0h |

表 7-80. GPO_CFG3 Register Field Descriptions

| Bit | Field | Type | Reset | Description |
|-----|---------------|------|-------|---|
| 7-4 | GPO4_CFG[3:0] | R/W | 0h | IN4M_GPO4 (GPO4) configuration. 0d = GPO4 is disabled 1d = GPO4 is configured as a general-purpose output (GPO) 2d = GPO4 is configured as a device interrupt output (IRQ) 3d = GPO4 is configured as a secondary ASI output (SDOUT2) 4d = GPO4 is configured as a PDM clock output (PDMCLK) 5d to 15d = Reserved |
| 3-1 | Reserved | R | 0h | Reserved |
| 0 | GPO4_DRV | R/W | 0h | 0d = GPO4 is in a Hi-Z state 1d = GPO4 is driven as Active High/Active Low |

7.6.1.1.27 GPO_VAL Register (page = 0x00, address = 0x29) [reset = 0h]

This register is the GPIO and GPO output value register.

図 7-99. GPO_VAL Register

| | | | | | | | |
|-----------|----------|----------|----------|----------|----------|---|---|
| 7 | 6 | 5 | 4 | 3 | 2 | 1 | 0 |
| GPIO1_VAL | GPO1_VAL | GPO2_VAL | GPO3_VAL | GPO4_VAL | Reserved | | |
| R/W-0h | R/W-0h | R/W-0h | R/W-0h | R/W-0h | R-0h | | |

表 7-81. GPO_VAL Register Field Descriptions

| Bit | Field | Type | Reset | Description |
|-----|-----------|------|-------|--|
| 7 | GPIO1_VAL | R/W | 0h | GPIO1 output value when configured as a GPO. 0d = Drive the output with a value of 0 1d = Drive the output with a value of 1 |

表 7-81. GPO_VAL Register Field Descriptions (続き)

| Bit | Field | Type | Reset | Description |
|-----|----------|------|-------|---|
| 6 | GPO1_VAL | R/W | 0h | GPO1 output value when configured as a GPO. 0d = Drive the output with a value of 0 1d = Drive the output with a value of 1 |
| 5 | GPO2_VAL | R/W | 0h | GPO2 output value when configured as a GPO. 0d = Drive the output with a value of 0 1d = Drive the output with a value of 1 |
| 4 | GPO3_VAL | R/W | 0h | GPO3 output value when configured as a GPO. 0d = Drive the output with a value of 0 1d = Drive the output with a value of 1 |
| 3 | GPO4_VAL | R/W | 0h | GPO4 output value when configured as a GPO. 0d = Drive the output with a value of 0 1d = Drive the output with a value of 1 |
| 2-0 | Reserved | R | 0h | Reserved |

7.6.1.1.28 GPIO_MON Register (page = 0x00, address = 0x2A) [reset = 0h]

This register is the GPIO monitor value register.

図 7-100. GPIO_MON Register

| 7 | 6 | 5 | 4 | 3 | 2 | 1 | 0 |
|-----------|---|----------|---|---|---|---|---|
| GPIO1_MON | | Reserved | | | | | |
| R-0h | | R-0h | | | | | |

表 7-82. GPIO_MON Register Field Descriptions

| Bit | Field | Type | Reset | Description |
|-----|-----------|------|-------|---|
| 7 | GPIO1_MON | R | 0h | GPIO1 monitor value when configured as a GPI. 0d = Input monitor value 0 1d = Input monitor value 1 |
| 6-0 | Reserved | R | 0h | Reserved |

7.6.1.1.29 GPI_CFG0 Register (page = 0x00, address = 0x2B) [reset = 0h]

This register is the GPI configuration register 0.

図 7-101. GPI_CFG0 Register

| 7 | 6 | 5 | 4 | 3 | 2 | 1 | 0 |
|----------|---|---------------|---|----------|---|---------------|---|
| Reserved | | GPI1_CFG[2:0] | | Reserved | | GPI2_CFG[2:0] | |
| R-0h | | R/W-0h | | R-0h | | R/W-0h | |

表 7-83. GPI_CFG0 Register Field Descriptions

| Bit | Field | Type | Reset | Description |
|-----|---------------|------|-------|--|
| 7 | Reserved | R | 0h | Reserved |
| 6-4 | GPI1_CFG[2:0] | R/W | 0h | IN1P_GPI1 (GPI1) configuration. 0d = GPI1 is disabled 1d = GPI1 is configured as a general-purpose input (GPI) 2d = GPI1 is configured as a master clock input (MCLK) 3d = GPI1 is configured as an ASI input for daisy-chain (SDIN) 4d = GPI1 is configured as a PDM data input for channel 1 and channel 2 (PDM DIN1) 5d = GPI1 is configured as a PDM data input for channel 3 and channel 4 (PDM DIN2) 6d = GPI1 is configured as a PDM data input for channel 5 and channel 6 (PDM DIN3) 7d = GPI1 is configured as a PDM data input for channel 7 and channel 8 (PDM DIN4) |
| 3 | Reserved | R | 0h | Reserved |

表 7-83. GPI_CFG0 Register Field Descriptions (続き)

| Bit | Field | Type | Reset | Description |
|-----|---------------|------|-------|--|
| 2-0 | GPI2_CFG[2:0] | R/W | 0h | IN2P_GPI2 (GPI2) configuration. 0d = GPI2 is disabled 1d = GPI2 is configured as a general-purpose input (GPI) 2d = GPI2 is configured as a master clock input (MCLK) 3d = GPI2 is configured as an ASI input for daisy-chain (SDIN) 4d = GPI2 is configured as a PDM data input for channel 1 and channel 2 (PDMIN1) 5d = GPI2 is configured as a PDM data input for channel 3 and channel 4 (PDMIN2) 6d = GPI2 is configured as a PDM data input for channel 5 and channel 6 (PDMIN3) 7d = GPI2 is configured as a PDM data input for channel 7 and channel 8 (PDMIN4) |

7.6.1.1.30 GPI_CFG1 Register (page = 0x00, address = 0x2C) [reset = 0h]

This register is the GPI configuration register 1.

図 7-102. GPI_CFG1 Register

| 7 | 6 | 5 | 4 | 3 | 2 | 1 | 0 |
|----------|---------------|---|---|----------|---------------|---|---|
| Reserved | GPI3_CFG[2:0] | | | Reserved | GPI4_CFG[2:0] | | |
| R-0h | R/W-0h | | | R-0h | R/W-0h | | |

表 7-84. GPI_CFG1 Register Field Descriptions

| Bit | Field | Type | Reset | Description |
|-----|---------------|------|-------|--|
| 7 | Reserved | R | 0h | Reserved |
| 6-4 | GPI3_CFG[2:0] | R/W | 0h | IN3P_GPI3 (GPI3) configuration. 0d = GPI3 is disabled 1d = GPI3 is configured as a general-purpose input (GPI) 2d = GPI3 is configured as a master clock input (MCLK) 3d = GPI3 is configured as an ASI input for daisy-chain (SDIN) 4d = GPI3 is configured as a PDM data input for channel 1 and channel 2 (PDMIN1) 5d = GPI3 is configured as a PDM data input for channel 3 and channel 4 (PDMIN2) 6d = GPI3 is configured as a PDM data input for channel 5 and channel 6 (PDMIN3) 7d = GPI3 is configured as a PDM data input for channel 7 and channel 8 (PDMIN4) |
| 3 | Reserved | R | 0h | Reserved |
| 2-0 | GPI4_CFG[2:0] | R/W | 0h | IN4P_GPI4 (GPI4) configuration. 0d = GPI4 is disabled 1d = GPI4 is configured as a general-purpose input (GPI) 2d = GPI4 is configured as a master clock input (MCLK) 3d = GPI4 is configured as an ASI input for daisy-chain (SDIN) 4d = GPI4 is configured as a PDM data input for channel 1 and channel 2 (PDMIN1) 5d = GPI4 is configured as a PDM data input for channel 3 and channel 4 (PDMIN2) 6d = GPI4 is configured as a PDM data input for channel 5 and channel 6 (PDMIN3) 7d = GPI4 is configured as a PDM data input for channel 7 and channel 8 (PDMIN4) |

7.6.1.1.31 GPI_MON Register (page = 0x00, address = 0x2F) [reset = 0h]

This register is the GPI monitor value register.

図 7-103. GPI_MON Register

| 7 | 6 | 5 | 4 | 3 | 2 | 1 | 0 |
|---|---|---|---|---|---|---|---|
|---|---|---|---|---|---|---|---|

図 7-103. GPI_MON Register (続き)

| | | | | |
|----------|----------|----------|----------|----------|
| GPI1_MON | GPI2_MON | GPI3_MON | GPI4_MON | Reserved |
| R-0h | R-0h | R-0h | R-0h | R-0h |

表 7-85. GPI_MON Register Field Descriptions

| Bit | Field | Type | Reset | Description |
|-----|----------|------|-------|--|
| 7 | GPI1_MON | R | 0h | GPI1 monitor value when configured as a GPI. 0d = Input monitor value 0 1d = Input monitor value 1 |
| 6 | GPI2_MON | R | 0h | GPI2 monitor value when configured as a GPI. 0d = Input monitor value 0 1d = Input monitor value 1 |
| 5 | GPI3_MON | R | 0h | GPI3 monitor value when configured as a GPI. 0d = Input monitor value 0 1d = Input monitor value 1 |
| 4 | GPI4_MON | R | 0h | GPI4 monitor value when configured as a GPI. 0d = Input monitor value 0 1d = Input monitor value 1 |
| 3-0 | Reserved | R | 0h | Reserved |

7.6.1.1.32 INT_CFG Register (page = 0x00, address = 0x32) [reset = 0h]

This register is the interrupt configuration register.

図 7-104. INT_CFG Register

| | | | | | | | |
|---------|----------------|---|----------|---|---------------|----------|---|
| 7 | 6 | 5 | 4 | 3 | 2 | 1 | 0 |
| INT_POL | INT_EVENT[1:0] | | Reserved | | LTCH_READ_CFG | Reserved | |
| R/W-0h | R/W-0h | | R-0h | | R/W-0h | R-0h | |

表 7-86. INT_CFG Register Field Descriptions

| Bit | Field | Type | Reset | Description |
|-----|----------------|------|-------|--|
| 7 | INT_POL | R/W | 0h | Interrupt polarity. 0b = Active low (IRQZ) 1b = Active high (IRQ) |
| 6-5 | INT_EVENT[1:0] | R/W | 0h | Interrupt event configuration. 0d = INT asserts on any unmasked latched interrupts event 1d = Reserved 2d = INT asserts for 2 ms (typical) for every 4-ms (typical) duration on any unmasked latched interrupts event 3d = INT asserts for 2 ms (typical) one time on each pulse for any unmasked interrupts event |
| 4-3 | Reserved | R | 0h | Reserved |
| 2 | LTCH_READ_CFG | R/W | 0h | Interrupt latch registers readback configuration. 0b = All interrupts can be read through the LTCH registers 1b = Only unmasked interrupts can be read through the LTCH registers |
| 1-0 | Reserved | R | 0h | Reserved |

7.6.1.1.33 INT_MASK0 Register (page = 0x00, address = 0x33) [reset = FFh]

This register is the interrupt masks register 0.

図 7-105. INT_MASK0 Register

| | | | | | | | |
|--------------|--------------|----------|---|---|---|---|---|
| 7 | 6 | 5 | 4 | 3 | 2 | 1 | 0 |
| INT_MASK0[7] | INT_MASK0[6] | Reserved | | | | | |
| R/W-1h | R/W-1h | R/W-3Fh | | | | | |

表 7-87. INT_MASK0 Register Field Descriptions

| Bit | Field | Type | Reset | Description |
|-----|--------------|------|-------|---|
| 7 | INT_MASK0[7] | R/W | 1h | ASI clock error mask. 0b = Do not mask 1b = Mask |
| 6 | INT_MASK0[6] | R/W | 1h | PLL lock interrupt mask. 0b = Do not mask 1b = Mask |
| 5-0 | Reserved | R/W | 3Fh | Reserved |

7.6.1.1.34 INT_LTCH0 Register (page = 0x00, address = 0x36) [reset = 0h]

This register is the latched interrupt readback register 0.

図 7-106. INT_LTCH0 Register

| 7 | 6 | 5 | 4 | 3 | 2 | 1 | 0 |
|--------------|--------------|----------|---|---|---|---|---|
| INT_LTCH0[7] | INT_LTCH0[6] | Reserved | | | | | |
| R-0h | R-0h | R-0h | | | | | |

表 7-88. INT_LTCH0 Register Field Descriptions

| Bit | Field | Type | Reset | Description |
|-----|--------------|------|-------|--|
| 7 | INT_LTCH0[7] | R | 0h | Interrupt caused by an ASI bus clock error (self-clearing bit). 0b = No interrupt 1b = Interrupt |
| 6 | INT_LTCH0[6] | R | 0h | Interrupt caused by PLL LOCK (self-clearing bit). 0b = No interrupt 1b = Interrupt |
| 5-0 | Reserved | R | 0h | Reserved |

7.6.1.1.35 BIAS_CFG Register (page = 0x00, address = 0x3B) [reset = 0h]

This register is the bias and ADC configuration register.

図 7-107. BIAS_CFG Register

| 7 | 6 | 5 | 4 | 3 | 2 | 1 | 0 |
|----------|----------------|---|---|----------|---|-----------------|---|
| Reserved | MBIAS_VAL[2:0] | | | Reserved | | ADC_FSCALE[1:0] | |
| R-0h | R/W-0h | | | R-0h | | R/W-0h | |

表 7-89. BIAS_CFG Register Field Descriptions

| Bit | Field | Type | Reset | Description |
|-----|-----------------|------|-------|---|
| 7 | Reserved | R | 0h | Reserved |
| 6-4 | MBIAS_VAL[2:0] | R/W | 0h | MICBIAS value. 0d = Microphone bias is set to VREF (2.750 V, 2.500 V, or 1.375 V) 1d = Microphone bias is set to VREF × 1.096 (3.014 V, 2.740 V, or 1.507 V) 2d to 5d = Reserved 6d = Microphone bias is set to AVDD |
| 3-2 | Reserved | R | 0h | Reserved |
| 1-0 | ADC_FSCALE[1:0] | R/W | 0h | ADC full-scale setting (configure this setting based on the AVDD supply minimum voltage used). 0d = VREF is set to 2.75 V to support 2 V _{RMS} for the differential input or 1 V _{RMS} for the single-ended input 1d = VREF is set to 2.5 V to support 1.818 V _{RMS} for the differential input or 0.909 V _{RMS} for the single-ended input 2d = VREF is set to 1.375 V to support 1 V _{RMS} for the differential input or 0.5 V _{RMS} for the single-ended input 3d = Reserved |

7.6.1.1.36 CH1_CFG0 Register (page = 0x00, address = 0x3C) [reset = 0h]

This register is configuration register 0 for channel 1.

図 7-108. CH1_CFG0 Register

| 7 | 6 | 5 | 4 | 3 | 2 | 1 | 0 |
|-----------|----------------|---|--------|--------------|---|----------|-----------|
| CH1_INTYP | CH1_INSRC[1:0] | | CH1_DC | CH1_IMP[1:0] | | Reserved | CH1_DREEN |
| R/W-0h | R/W-0h | | R/W-0h | R/W-0h | | R-0h | R/W-0h |

表 7-90. CH1_CFG0 Register Field Descriptions

| Bit | Field | Type | Reset | Description |
|-----|----------------|------|-------|--|
| 7 | CH1_INTYP | R/W | 0h | Channel 1 input type. 0d = Microphone input 1d = Line input |
| 6-5 | CH1_INSRC[1:0] | R/W | 0h | Channel 1 input configuration. 0d = Analog differential input (the GPI1 and GPO1 pin functions must be disabled) 1d = Analog single-ended input (the GPI1 and GPO1 pin functions must be disabled) 2d = Digital microphone PDM input (configure the GPO and GPI pins accordingly for PDMDIN1 and PDMCLK) 3d = Reserved |
| 4 | CH1_DC | R/W | 0h | Channel 1 input coupling (applicable for the analog input). 0d = AC-coupled input 1d = DC-coupled input |
| 3-2 | CH1_IMP[1:0] | R/W | 0h | Channel 1 input impedance (applicable for the analog input). 0d = Typical 2.5-kΩ input impedance 1d = Typical 10-kΩ input impedance 2d = Typical 20-kΩ input impedance 3d = Reserved |
| 1 | Reserved | R | 0h | Reserved |
| 0 | CH1_DREEN | R/W | 0h | Channel 1 dynamic range enhancer (DRE) and automatic gain controller (AGC) setting. 0d = DRE and AGC disabled 1d = DRE or AGC enabled based on the configuration of bit 3 in register 108 (P0_R108) |

7.6.1.1.37 CH1_CFG1 Register (page = 0x00, address = 0x3D) [reset = 0h]

This register is configuration register 1 for channel 1.

図 7-109. CH1_CFG1 Register

| 7 | 6 | 5 | 4 | 3 | 2 | 1 | 0 |
|---------------|---|---|---|---|---|----------|---|
| CH1_GAIN[5:0] | | | | | | Reserved | |
| R/W-0h | | | | | | R-0h | |

表 7-91. CH1_CFG1 Register Field Descriptions

| Bit | Field | Type | Reset | Description |
|-----|---------------|------|-------|--|
| 7-2 | CH1_GAIN[5:0] | R/W | 0h | Channel 1 gain. 0d = Channel gain is set to 0 dB 1d = Channel gain is set to 1 dB 2d = Channel gain is set to 2 dB 3d to 41d = Channel gain is set as per configuration 42d = Channel gain is set to 42 dB 43d to 63d = Reserved |
| 1-0 | Reserved | R | 0h | Reserved |

7.6.1.1.38 CH1_CFG2 Register (page = 0x00, address = 0x3E) [reset = C9h]

This register is configuration register 2 for channel 1.

☒ 7-110. CH1_CFG2 Register

| | | | | | | | |
|---------------|---|---|---|---|---|---|---|
| 7 | 6 | 5 | 4 | 3 | 2 | 1 | 0 |
| CH1_DVOL[7:0] | | | | | | | |
| R/W-C9h | | | | | | | |

表 7-92. CH1_CFG2 Register Field Descriptions

| Bit | Field | Type | Reset | Description |
|-----|---------------|------|-------|--|
| 7-0 | CH1_DVOL[7:0] | R/W | C9h | Channel 1 digital volume control. 0d = Digital volume is muted 1d = Digital volume control is set to -100 dB 2d = Digital volume control is set to -99.5 dB 3d to 200d = Digital volume control is set as per configuration 201d = Digital volume control is set to 0 dB 202d = Digital volume control is set to 0.5 dB 203d to 253d = Digital volume control is set as per configuration 254d = Digital volume control is set to 26.5 dB 255d = Digital volume control is set to 27 dB |

7.6.1.1.39 CH1_CFG3 Register (page = 0x00, address = 0x3F) [reset = 80h]

This register is configuration register 3 for channel 1.

☒ 7-111. CH1_CFG3 Register

| | | | | | | | |
|---------------|---|---|---|----------|---|---|---|
| 7 | 6 | 5 | 4 | 3 | 2 | 1 | 0 |
| CH1_GCAL[3:0] | | | | Reserved | | | |
| R/W-8h | | | | R-0h | | | |

表 7-93. CH1_CFG3 Register Field Descriptions

| Bit | Field | Type | Reset | Description |
|-----|---------------|------|-------|--|
| 7-4 | CH1_GCAL[3:0] | R/W | 8h | Channel 1 gain calibration. 0d = Gain calibration is set to -0.8 dB 1d = Gain calibration is set to -0.7 dB 2d = Gain calibration is set to -0.6 dB 3d to 7d = Gain calibration is set as per configuration 8d = Gain calibration is set to 0 dB 9d = Gain calibration is set to 0.1 dB 10d to 13d = Gain calibration is set as per configuration 14d = Gain calibration is set to 0.6 dB 15d = Gain calibration is set to 0.7 dB |
| 3-0 | Reserved | R | 0h | Reserved |

7.6.1.1.40 CH1_CFG4 Register (page = 0x00, address = 0x40) [reset = 0h]

This register is configuration register 4 for channel 1.

☒ 7-112. CH1_CFG4 Register

| | | | | | | | |
|---------------|---|---|---|---|---|---|---|
| 7 | 6 | 5 | 4 | 3 | 2 | 1 | 0 |
| CH1_PCAL[7:0] | | | | | | | |
| R/W-0h | | | | | | | |

表 7-94. CH1_CFG4 Register Field Descriptions

| Bit | Field | Type | Reset | Description |
|-----|---------------|------|-------|---|
| 7-0 | CH1_PCAL[7:0] | R/W | 0h | Channel 1 phase calibration with modulator clock resolution. 0d = No phase calibration 1d = Phase calibration delay is set to one cycle of the modulator clock 2d = Phase calibration delay is set to two cycles of the modulator clock 3d to 254d = Phase calibration delay as per configuration 255d = Phase calibration delay is set to 255 cycles of the modulator clock |

7.6.1.1.41 CH2_CFG0 Register (page = 0x00, address = 0x41) [reset = 0h]

This register is configuration register 0 for channel 2.

図 7-113. CH2_CFG0 Register

| 7 | 6 | 5 | 4 | 3 | 2 | 1 | 0 |
|-----------|----------------|---|--------|--------------|---|----------|-----------|
| CH2_INTYP | CH2_INSRC[1:0] | | CH2_DC | CH2_IMP[1:0] | | Reserved | CH2_DREEN |
| R/W-0h | R/W-0h | | R/W-0h | R/W-0h | | R-0h | R/W-0h |

表 7-95. CH2_CFG0 Register Field Descriptions

| Bit | Field | Type | Reset | Description |
|-----|----------------|------|-------|--|
| 7 | CH2_INTYP | R/W | 0h | Channel 2 input type. 0d = Microphone input 1d = Line input |
| 6-5 | CH2_INSRC[1:0] | R/W | 0h | Channel 2 input configuration. 0d = Analog differential input (the GPI2 and GPO2 pin functions must be disabled) 1d = Analog single-ended input (the GPI2 and GPO2 pin functions must be disabled) 2d = Digital microphone PDM input (configure the GPO and GPI pins accordingly for PDMDIN1 and PDMCLK) 3d = Reserved |
| 4 | CH2_DC | R/W | 0h | Channel 2 input coupling (applicable for the analog input). 0d = AC-coupled input 1d = DC-coupled input |
| 3-2 | CH2_IMP[1:0] | R/W | 0h | Channel 2 input impedance (applicable for the analog input). 0d = Typical 2.5-k Ω input impedance 1d = Typical 10-k Ω input impedance 2d = Typical 20-k Ω input impedance 3d = Reserved |
| 1 | Reserved | R | 0h | Reserved |
| 0 | CH2_DREEN | R/W | 0h | Channel 2 dynamic range enhancer (DRE) and automatic gain controller (AGC) setting. 0d = DRE and AGC disabled 1d = DRE or AGC enabled based on the configuration of bit 3 in register 108 (P0_R108) |

7.6.1.1.42 CH2_CFG1 Register (page = 0x00, address = 0x42) [reset = 0h]

This register is configuration register 1 for channel 2.

図 7-114. CH2_CFG1 Register

| 7 | 6 | 5 | 4 | 3 | 2 | 1 | 0 |
|---------------|---|---|---|---|---|----------|---|
| CH2_GAIN[5:0] | | | | | | Reserved | |
| R/W-0h | | | | | | R-0h | |

表 7-96. CH2_CFG1 Register Field Descriptions

| Bit | Field | Type | Reset | Description |
|-----|---------------|------|-------|--|
| 7-2 | CH2_GAIN[5:0] | R/W | 0h | Channel 2 gain. 0d = Channel gain is set to 0 dB 1d = Channel gain is set to 1 dB 2d = Channel gain is set to 2 dB 3d to 41d = Channel gain is set as per configuration 42d = Channel gain is set to 42 dB 43d to 63d = Reserved |
| 1-0 | Reserved | R | 0h | Reserved |

7.6.1.1.43 CH2_CFG2 Register (page = 0x00, address = 0x43) [reset = C9h]

This register is configuration register 2 for channel 2.

図 7-115. CH2_CFG2 Register

| 7 | 6 | 5 | 4 | 3 | 2 | 1 | 0 |
|---------------|---|---|---|---|---|---|---|
| CH2_DVOL[7:0] | | | | | | | |
| R/W-C9h | | | | | | | |

表 7-97. CH2_CFG2 Register Field Descriptions

| Bit | Field | Type | Reset | Description |
|-----|---------------|------|-------|--|
| 7-0 | CH2_DVOL[7:0] | R/W | C9h | Channel 2 digital volume control. 0d = Digital volume is muted 1d = Digital volume control is set to -100 dB 2d = Digital volume control is set to -99.5 dB 3d to 200d = Digital volume control is set as per configuration 201d = Digital volume control is set to 0 dB 202d = Digital volume control is set to 0.5 dB 203d to 253d = Digital volume control is set as per configuration 254d = Digital volume control is set to 26.5 dB 255d = Digital volume control is set to 27 dB |

7.6.1.1.44 CH2_CFG3 Register (page = 0x00, address = 0x44) [reset = 80h]

This register is configuration register 3 for channel 2.

図 7-116. CH2_CFG3 Register

| 7 | 6 | 5 | 4 | 3 | 2 | 1 | 0 |
|---------------|---|---|---|----------|---|---|---|
| CH2_GCAL[3:0] | | | | Reserved | | | |
| R/W-8h | | | | R-0h | | | |

表 7-98. CH2_CFG3 Register Field Descriptions

| Bit | Field | Type | Reset | Description |
|-----|---------------|------|-------|--|
| 7-4 | CH2_GCAL[3:0] | R/W | 8h | Channel 2 gain calibration. 0d = Gain calibration is set to -0.8 dB 1d = Gain calibration is set to -0.7 dB 2d = Gain calibration is set to -0.6 dB 3d to 7d = Gain calibration is set as per configuration 8d = Gain calibration is set to 0 dB 9d = Gain calibration is set to 0.1 dB 10d to 13d = Gain calibration is set as per configuration 14d = Gain calibration is set to 0.6 dB 15d = Gain calibration is set to 0.7 dB |
| 3-0 | Reserved | R | 0h | Reserved |

7.6.1.1.45 CH2_CFG4 Register (page = 0x00, address = 0x45) [reset = 0h]

This register is configuration register 4 for channel 2.

☒ 7-117. CH2_CFG4 Register

| | | | | | | | |
|---------------|---|---|---|---|---|---|---|
| 7 | 6 | 5 | 4 | 3 | 2 | 1 | 0 |
| CH2_PCAL[7:0] | | | | | | | |
| R/W-0h | | | | | | | |

表 7-99. CH2_CFG4 Register Field Descriptions

| Bit | Field | Type | Reset | Description |
|-----|---------------|------|-------|---|
| 7-0 | CH2_PCAL[7:0] | R/W | 0h | Channel 2 phase calibration with modulator clock resolution. 0d = No phase calibration 1d = Phase calibration delay is set to one cycle of the modulator clock 2d = Phase calibration delay is set to two cycles of the modulator clock 3d to 254d = Phase calibration delay as per configuration 255d = Phase calibration delay is set to 255 cycles of the modulator clock |

7.6.1.1.46 CH3_CFG0 Register (page = 0x00, address = 0x46) [reset = 0h]

This register is configuration register 0 for channel 3.

☒ 7-118. CH3_CFG0 Register

| | | | | | | | |
|-----------|----------------|---|--------|--------------|---|----------|-----------|
| 7 | 6 | 5 | 4 | 3 | 2 | 1 | 0 |
| CH3_INTYP | CH3_INSRC[1:0] | | CH3_DC | CH3_IMP[1:0] | | Reserved | CH3_DREEN |
| R/W-0h | R/W-0h | | R/W-0h | R/W-0h | | R-0h | R/W-0h |

表 7-100. CH3_CFG0 Register Field Descriptions

| Bit | Field | Type | Reset | Description |
|-----|----------------|------|-------|--|
| 7 | CH3_INTYP | R/W | 0h | Channel 3 input type. 0d = Microphone input 1d = Line input |
| 6-5 | CH3_INSRC[1:0] | R/W | 0h | Channel 3 input configuration. 0d = Analog differential input (the GPI3 and GPO3 pin functions must be disabled) 1d = Analog single-ended input (the GPI3 and GPO3 pin functions must be disabled) 2d = Digital microphone PDM input (configure the GPO and GPI pins accordingly for PDMDIN2 and PDMCLK) 3d = Reserved |
| 4 | CH3_DC | R/W | 0h | Channel 3 input coupling (applicable for the analog input). 0d = AC-coupled input 1d = DC-coupled input |
| 3-2 | CH3_IMP[1:0] | R/W | 0h | Channel 3 input impedance (applicable for the analog input). 0d = Typical 2.5-kΩ input impedance 1d = Typical 10-kΩ input impedance 2d = Typical 20-kΩ input impedance 3d = Reserved |
| 1 | Reserved | R | 0h | Reserved |
| 0 | CH3_DREEN | R/W | 0h | Channel 3 dynamic range enhancer (DRE) and automatic gain controller (AGC) setting. 0d = DRE and AGC disabled 1d = DRE or AGC enabled based on the configuration of bit 3 in register 108 (P0_R108) |

7.6.1.1.47 CH3_CFG1 Register (page = 0x00, address = 0x47) [reset = 0h]

This register is configuration register 1 for channel 3.

☒ 7-119. CH3_CFG1 Register

| | | | | | | | |
|---------------|---|---|---|---|---|----------|---|
| 7 | 6 | 5 | 4 | 3 | 2 | 1 | 0 |
| CH3_GAIN[5:0] | | | | | | Reserved | |

図 7-119. CH3_CFG1 Register (続き)

| | |
|--------|------|
| R/W-0h | R-0h |
|--------|------|

表 7-101. CH3_CFG1 Register Field Descriptions

| Bit | Field | Type | Reset | Description |
|-----|---------------|------|-------|--|
| 7-2 | CH3_GAIN[5:0] | R/W | 0h | Channel 3 gain. 0d = Channel gain is set to 0 dB 1d = Channel gain is set to 1 dB 2d = Channel gain is set to 2 dB 3d to 41d = Channel gain is set as per configuration 42d = Channel gain is set to 42 dB 43d to 63d = Reserved |
| 1-0 | Reserved | R | 0h | Reserved |

7.6.1.1.48 CH3_CFG2 Register (page = 0x00, address = 0x48) [reset = C9h]

This register is configuration register 2 for channel 3.

図 7-120. CH3_CFG2 Register

| | | | | | | | |
|---------------|---|---|---|---|---|---|---|
| 7 | 6 | 5 | 4 | 3 | 2 | 1 | 0 |
| CH3_DVOL[7:0] | | | | | | | |
| R/W-C9h | | | | | | | |

表 7-102. CH3_CFG2 Register Field Descriptions

| Bit | Field | Type | Reset | Description |
|-----|---------------|------|-------|--|
| 7-0 | CH3_DVOL[7:0] | R/W | C9h | Channel 3 digital volume control. 0d = Digital volume is muted 1d = Digital volume control is set to -100 dB 2d = Digital volume control is set to -99.5 dB 3d to 200d = Digital volume control is set as per configuration 201d = Digital volume control is set to 0 dB 202d = Digital volume control is set to 0.5 dB 203d to 253d = Digital volume control is set as per configuration 254d = Digital volume control is set to 26.5 dB 255d = Digital volume control is set to 27 dB |

7.6.1.1.49 CH3_CFG3 Register (page = 0x00, address = 0x49) [reset = 80h]

This register is configuration register 3 for channel 3.

図 7-121. CH3_CFG3 Register

| | | | | | | | |
|---------------|---|---|---|----------|---|---|---|
| 7 | 6 | 5 | 4 | 3 | 2 | 1 | 0 |
| CH3_GCAL[3:0] | | | | Reserved | | | |
| R/W-8h | | | | R-0h | | | |

表 7-103. CH3_CFG3 Register Field Descriptions

| Bit | Field | Type | Reset | Description |
|-----|---------------|------|-------|--|
| 7-4 | CH3_GCAL[3:0] | R/W | 8h | Channel 3 gain calibration. 0d = Gain calibration is set to -0.8 dB 1d = Gain calibration is set to -0.7 dB 2d = Gain calibration is set to -0.6 dB 3d to 7d = Gain calibration is set as per configuration 8d = Gain calibration is set to 0 dB 9d = Gain calibration is set to 0.1 dB 10d to 13d = Gain calibration is set as per configuration 14d = Gain calibration is set to 0.6 dB 15d = Gain calibration is set to 0.7 dB |
| 3-0 | Reserved | R | 0h | Reserved |

7.6.1.1.50 CH3_CFG4 Register (page = 0x00, address = 0x4A) [reset = 0h]

This register is configuration register 4 for channel 3.

図 7-122. CH3_CFG4 Register

| | | | | | | | |
|---------------|---|---|---|---|---|---|---|
| 7 | 6 | 5 | 4 | 3 | 2 | 1 | 0 |
| CH3_PCAL[7:0] | | | | | | | |
| R/W-0h | | | | | | | |

表 7-104. CH3_CFG4 Register Field Descriptions

| Bit | Field | Type | Reset | Description |
|-----|---------------|------|-------|---|
| 7-0 | CH3_PCAL[7:0] | R/W | 0h | Channel 3 phase calibration with modulator clock resolution. 0d = No phase calibration 1d = Phase calibration delay is set to one cycle of the modulator clock 2d = Phase calibration delay is set to two cycles of the modulator clock 3d to 254d = Phase calibration delay as per configuration 255d = Phase calibration delay is set to 255 cycles of the modulator clock |

7.6.1.1.51 CH4_CFG0 Register (page = 0x00, address = 0x4B) [reset = 0h]

This register is configuration register 0 for channel 4.

図 7-123. CH4_CFG0 Register

| | | | | | | | |
|-----------|----------------|---|--------|--------------|---|----------|-----------|
| 7 | 6 | 5 | 4 | 3 | 2 | 1 | 0 |
| CH4_INTYP | CH4_INSRC[1:0] | | CH4_DC | CH4_IMP[1:0] | | Reserved | CH4_DREEN |
| R/W-0h | R/W-0h | | R/W-0h | R/W-0h | | R-0h | R/W-0h |

表 7-105. CH4_CFG0 Register Field Descriptions

| Bit | Field | Type | Reset | Description |
|-----|----------------|------|-------|--|
| 7 | CH4_INTYP | R/W | 0h | Channel 4 input type. 0d = Microphone input 1d = Line input |
| 6-5 | CH4_INSRC[1:0] | R/W | 0h | Channel 4 input configuration. 0d = Analog differential input (the GPI4 and GPO4 pin functions must be disabled) 1d = Analog single-ended input (the GPI4 and GPO4 pin functions must be disabled) 2d = Digital microphone PDM input (configure the GPO and GPI pins accordingly for PDMDIN2 and PDMCLK) 3d = Reserved |
| 4 | CH4_DC | R/W | 0h | Channel 4 input coupling (applicable for the analog input). 0d = AC-coupled input 1d = DC-coupled input |
| 3-2 | CH4_IMP[1:0] | R/W | 0h | Channel 4 input impedance (applicable for the analog input). 0d = Typical 2.5-kΩ input impedance 1d = Typical 10-kΩ input impedance 2d = Typical 20-kΩ input impedance 3d = Reserved |
| 1 | Reserved | R | 0h | Reserved |
| 0 | CH4_DREEN | R/W | 0h | Channel 4 dynamic range enhancer (DRE) and automatic gain controller (AGC) setting. 0d = DRE and AGC disabled 1d = DRE or AGC enabled based on the configuration of bit 3 in register 108 (P0_R108) |

7.6.1.1.52 CH4_CFG1 Register (page = 0x00, address = 0x4C) [reset = 0h]

This register is configuration register 1 for channel 4.

☒ 7-124. CH4_CFG1 Register

| | | | | | | | |
|---------------|---|---|---|---|---|----------|---|
| 7 | 6 | 5 | 4 | 3 | 2 | 1 | 0 |
| CH4_GAIN[5:0] | | | | | | Reserved | |
| R/W-0h | | | | | | R-0h | |

表 7-106. CH4_CFG1 Register Field Descriptions

| Bit | Field | Type | Reset | Description |
|-----|---------------|------|-------|--|
| 7-2 | CH4_GAIN[5:0] | R/W | 0h | Channel 4 gain. 0d = Channel gain is set to 0 dB 1d = Channel gain is set to 1 dB 2d = Channel gain is set to 2 dB 3d to 41d = Channel gain is set as per configuration 42d = Channel gain is set to 42 dB 43d to 63d = Reserved |
| 1-0 | Reserved | R | 0h | Reserved |

7.6.1.1.53 CH4_CFG2 Register (page = 0x00, address = 0x4D) [reset = C9h]

This register is configuration register 2 for channel 4.

☒ 7-125. CH4_CFG2 Register

| | | | | | | | |
|---------------|---|---|---|---|---|---|---|
| 7 | 6 | 5 | 4 | 3 | 2 | 1 | 0 |
| CH4_DVOL[7:0] | | | | | | | |
| R/W-C9h | | | | | | | |

表 7-107. CH4_CFG2 Register Field Descriptions

| Bit | Field | Type | Reset | Description |
|-----|---------------|------|-------|--|
| 7-0 | CH4_DVOL[7:0] | R/W | C9h | Channel 4 digital volume control. 0d = Digital volume is muted 1d = Digital volume control is set to -100 dB 2d = Digital volume control is set to -99.5 dB 3d to 200d = Digital volume control is set as per configuration 201d = Digital volume control is set to 0 dB 202d = Digital volume control is set to 0.5 dB 203d to 253d = Digital volume control is set as per configuration 254d = Digital volume control is set to 26.5 dB 255d = Digital volume control is set to 27 dB |

7.6.1.1.54 CH4_CFG3 Register (page = 0x00, address = 0x4E) [reset = 80h]

This register is configuration register 3 for channel 4.

☒ 7-126. CH4_CFG3 Register

| | | | | | | | |
|---------------|---|---|---|----------|---|---|---|
| 7 | 6 | 5 | 4 | 3 | 2 | 1 | 0 |
| CH4_GCAL[3:0] | | | | Reserved | | | |
| R/W-8h | | | | R-0h | | | |

表 7-108. CH4_CFG3 Register Field Descriptions

| Bit | Field | Type | Reset | Description |
|-----|---------------|------|-------|--|
| 7-4 | CH4_GCAL[3:0] | R/W | 8h | Channel 4 gain calibration. 0d = Gain calibration is set to -0.8 dB 1d = Gain calibration is set to -0.7 dB 2d = Gain calibration is set to -0.6 dB 3d to 7d = Gain calibration is set as per configuration 8d = Gain calibration is set to 0 dB 9d = Gain calibration is set to 0.1 dB 10d to 13d = Gain calibration is set as per configuration 14d = Gain calibration is set to 0.6 dB 15d = Gain calibration is set to 0.7 dB |

表 7-108. CH4_CFG3 Register Field Descriptions (続き)

| Bit | Field | Type | Reset | Description |
|-----|----------|------|-------|-------------|
| 3-0 | Reserved | R | 0h | Reserved |

7.6.1.1.55 CH4_CFG4 Register (page = 0x00, address = 0x4F) [reset = 0h]

This register is configuration register 4 for channel 4.

図 7-127. CH4_CFG4 Register

| 7 | 6 | 5 | 4 | 3 | 2 | 1 | 0 |
|---------------|---|---|---|---|---|---|---|
| CH4_PCAL[7:0] | | | | | | | |
| R/W-0h | | | | | | | |

表 7-109. CH4_CFG4 Register Field Descriptions

| Bit | Field | Type | Reset | Description |
|-----|---------------|------|-------|---|
| 7-0 | CH4_PCAL[7:0] | R/W | 0h | Channel 4 phase calibration with modulator clock resolution. 0d = No phase calibration 1d = Phase calibration delay is set to one cycle of the modulator clock 2d = Phase calibration delay is set to two cycles of the modulator clock 3d to 254d = Phase calibration delay as per configuration 255d = Phase calibration delay is set to 255 cycles of the modulator clock |

7.6.1.1.56 CH5_CFG2 Register (page = 0x00, address = 0x52) [reset = C9h]

This register is configuration register 2 for channel 5 (for the digital microphone PDM input only).

図 7-128. CH5_CFG2 Register

| 7 | 6 | 5 | 4 | 3 | 2 | 1 | 0 |
|---------------|---|---|---|---|---|---|---|
| CH5_DVOL[7:0] | | | | | | | |
| R/W-C9h | | | | | | | |

表 7-110. CH5_CFG2 Register Field Descriptions

| Bit | Field | Type | Reset | Description |
|-----|---------------|------|-------|--|
| 7-0 | CH5_DVOL[7:0] | R/W | C9h | Channel 5 digital volume control. 0d = Digital volume is muted 1d = Digital volume control is set to -100 dB 2d = Digital volume control is set to -99.5 dB 3d to 200d = Digital volume control is set as per configuration 201d = Digital volume control is set to 0 dB 202d = Digital volume control is set to 0.5 dB 203d to 253d = Digital volume control is set as per configuration 254d = Digital volume control is set to 26.5 dB 255d = Digital volume control is set to 27 dB |

7.6.1.1.57 CH5_CFG3 Register (page = 0x00, address = 0x53) [reset = 80h]

This register is configuration register 3 for channel 5 (for the digital microphone PDM input only).

図 7-129. CH5_CFG3 Register

| 7 | 6 | 5 | 4 | 3 | 2 | 1 | 0 |
|---------------|---|---|---|----------|---|---|---|
| CH5_GCAL[3:0] | | | | Reserved | | | |
| R/W-8h | | | | R-0h | | | |

表 7-111. CH5_CFG3 Register Field Descriptions

| Bit | Field | Type | Reset | Description |
|-----|---------------|------|-------|--|
| 7-4 | CH5_GCAL[3:0] | R/W | 8h | Channel 5 gain calibration. 0d = Gain calibration is set to -0.8 dB 1d = Gain calibration is set to -0.7 dB 2d = Gain calibration is set to -0.6 dB 3d to 7d = Gain calibration is set as per configuration 8d = Gain calibration is set to 0 dB 9d = Gain calibration is set to 0.1 dB 10d to 13d = Gain calibration is set as per configuration 14d = Gain calibration is set to 0.6 dB 15d = Gain calibration is set to 0.7 dB |
| 3-0 | Reserved | R | 0h | Reserved |

7.6.1.1.58 CH5_CFG4 Register (page = 0x00, address = 0x54) [reset = 0h]

This register is configuration register 4 for channel 5 (for the digital microphone PDM input only).

図 7-130. CH5_CFG4 Register

| 7 | 6 | 5 | 4 | 3 | 2 | 1 | 0 |
|---------------|---|---|---|---|---|---|---|
| CH5_PCAL[7:0] | | | | | | | |
| R/W-0h | | | | | | | |

表 7-112. CH5_CFG4 Register Field Descriptions

| Bit | Field | Type | Reset | Description |
|-----|---------------|------|-------|---|
| 7-0 | CH5_PCAL[7:0] | R/W | 0h | Channel 5 phase calibration with modulator clock resolution. 0d = No phase calibration 1d = Phase calibration delay is set to one cycle of the modulator clock 2d = Phase calibration delay is set to two cycles of the modulator clock 3d to 254d = Phase calibration delay as per configuration 255d = Phase calibration delay is set to 255 cycles of the modulator clock |

7.6.1.1.59 CH6_CFG2 Register (page = 0x00, address = 0x57) [reset = C9h]

This register is configuration register 2 for channel 6 (for the digital microphone PDM input only).

図 7-131. CH6_CFG2 Register

| 7 | 6 | 5 | 4 | 3 | 2 | 1 | 0 |
|---------------|---|---|---|---|---|---|---|
| CH6_DVOL[7:0] | | | | | | | |
| R/W-C9h | | | | | | | |

表 7-113. CH6_CFG2 Register Field Descriptions

| Bit | Field | Type | Reset | Description |
|-----|---------------|------|-------|--|
| 7-0 | CH6_DVOL[7:0] | R/W | C9h | Channel 6 digital volume control. 0d = Digital volume is muted 1d = Digital volume control is set to -100 dB 2d = Digital volume control is set to -99.5 dB 3d to 200d = Digital volume control is set as per configuration 201d = Digital volume control is set to 0 dB 202d = Digital volume control is set to 0.5 dB 203d to 253d = Digital volume control is set as per configuration 254d = Digital volume control is set to 26.5 dB 255d = Digital volume control is set to 27 dB |

7.6.1.1.60 CH6_CFG3 Register (page = 0x00, address = 0x58) [reset = 80h]

This register is configuration register 3 for channel 6 (for the digital microphone PDM input only).

図 7-132. CH6_CFG3 Register

| 7 | 6 | 5 | 4 | 3 | 2 | 1 | 0 |
|---|---|---|---|---|---|---|---|
|---|---|---|---|---|---|---|---|

 **7-132. CH6_CFG3 Register (続き)**

| | |
|---------------|----------|
| CH6_GCAL[3:0] | Reserved |
| R/W-8h | R-0h |

表 7-114. CH6_CFG3 Register Field Descriptions

| Bit | Field | Type | Reset | Description |
|-----|---------------|------|-------|--|
| 7-4 | CH6_GCAL[3:0] | R/W | 8h | Channel 6 gain calibration. 0d = Gain calibration is set to –0.8 dB 1d = Gain calibration is set to –0.7 dB 2d = Gain calibration is set to –0.6 dB 3d to 7d = Gain calibration is set as per configuration 8d = Gain calibration is set to 0 dB 9d = Gain calibration is set to 0.1 dB 10d to 13d = Gain calibration is set as per configuration 14d = Gain calibration is set to 0.6 dB 15d = Gain calibration is set to 0.7 dB |
| 3-0 | Reserved | R | 0h | Reserved |

7.6.1.1.61 CH6_CFG4 Register (page = 0x00, address = 0x59) [reset = 0h]

This register is configuration register 4 for channel 6 (for the digital microphone PDM input only).

 **7-133. CH6_CFG4 Register**

| | | | | | | | |
|---------------|---|---|---|---|---|---|---|
| 7 | 6 | 5 | 4 | 3 | 2 | 1 | 0 |
| CH6_PCAL[7:0] | | | | | | | |
| R/W-0h | | | | | | | |

表 7-115. CH6_CFG4 Register Field Descriptions

| Bit | Field | Type | Reset | Description |
|-----|---------------|------|-------|---|
| 7-0 | CH6_PCAL[7:0] | R/W | 0h | Channel 6 phase calibration with modulator clock resolution. 0d = No phase calibration 1d = Phase calibration delay is set to one cycle of the modulator clock 2d = Phase calibration delay is set to two cycles of the modulator clock 3d to 254d = Phase calibration delay as per configuration 255d = Phase calibration delay is set to 255 cycles of the modulator clock |

7.6.1.1.62 CH7_CFG2 Register (page = 0x00, address = 0x5C) [reset = C9h]

This register is configuration register 2 for channel 7 (for the digital microphone PDM input only).

 **7-134. CH7_CFG2 Register**

| | | | | | | | |
|---------------|---|---|---|---|---|---|---|
| 7 | 6 | 5 | 4 | 3 | 2 | 1 | 0 |
| CH7_DVOL[7:0] | | | | | | | |
| R/W-C9h | | | | | | | |

表 7-116. CH7_CFG2 Register Field Descriptions

| Bit | Field | Type | Reset | Description |
|-----|---------------|------|-------|--|
| 7-0 | CH7_DVOL[7:0] | R/W | C9h | Channel 7 digital volume control. 0d = Digital volume is muted 1d = Digital volume control is set to –100 dB 2d = Digital volume control is set to –99.5 dB 3d to 200d = Digital volume control is set as per configuration 201d = Digital volume control is set to 0 dB 202d = Digital volume control is set to 0.5 dB 203d to 253d = Digital volume control is set as per configuration 254d = Digital volume control is set to 26.5 dB 255d = Digital volume control is set to 27 dB |

7.6.1.1.63 CH7_CFG3 Register (page = 0x00, address = 0x5D) [reset = 80h]

This register is configuration register 3 for channel 7 (for the digital microphone PDM input only).

☒ 7-135. CH7_CFG3 Register

| | | | | | | | |
|---------------|---|---|---|----------|---|---|---|
| 7 | 6 | 5 | 4 | 3 | 2 | 1 | 0 |
| CH7_GCAL[3:0] | | | | Reserved | | | |
| R/W-8h | | | | R-0h | | | |

表 7-117. CH7_CFG3 Register Field Descriptions

| Bit | Field | Type | Reset | Description |
|-----|---------------|------|-------|--|
| 7-4 | CH7_GCAL[3:0] | R/W | 8h | Channel 7 gain calibration. 0d = Gain calibration is set to -0.8 dB 1d = Gain calibration is set to -0.7 dB 2d = Gain calibration is set to -0.6 dB 3d to 7d = Gain calibration is set as per configuration 8d = Gain calibration is set to 0 dB 9d = Gain calibration is set to 0.1 dB 10d to 13d = Gain calibration is set as per configuration 14d = Gain calibration is set to 0.6 dB 15d = Gain calibration is set to 0.7 dB |
| 3-0 | Reserved | R | 0h | Reserved |

7.6.1.1.64 CH7_CFG4 Register (page = 0x00, address = 0x5E) [reset = 0h]

This register is configuration register 4 for channel 7 (for the digital microphone PDM input only).

☒ 7-136. CH7_CFG4 Register

| | | | | | | | |
|---------------|---|---|---|---|---|---|---|
| 7 | 6 | 5 | 4 | 3 | 2 | 1 | 0 |
| CH7_PCAL[7:0] | | | | | | | |
| R/W-0h | | | | | | | |

表 7-118. CH7_CFG4 Register Field Descriptions

| Bit | Field | Type | Reset | Description |
|-----|---------------|------|-------|---|
| 7-0 | CH7_PCAL[7:0] | R/W | 0h | Channel 7 phase calibration with modulator clock resolution. 0d = No phase calibration 1d = Phase calibration delay is set to one cycle of the modulator clock 2d = Phase calibration delay is set to two cycles of the modulator clock 3d to 254d = Phase calibration delay as per configuration 255d = Phase calibration delay is set to 255 cycles of the modulator clock |

7.6.1.1.65 CH8_CFG2 Register (page = 0x00, address = 0x61) [reset = C9h]

This register is configuration register 2 for channel 8 (for the digital microphone PDM input only).

☒ 7-137. CH8_CFG2 Register

| | | | | | | | |
|---------------|---|---|---|---|---|---|---|
| 7 | 6 | 5 | 4 | 3 | 2 | 1 | 0 |
| CH8_DVOL[7:0] | | | | | | | |
| R/W-C9h | | | | | | | |

表 7-119. CH8_CFG2 Register Field Descriptions

| Bit | Field | Type | Reset | Description |
|-----|---------------|------|-------|--|
| 7-0 | CH8_DVOL[7:0] | R/W | C9h | Channel 8 digital volume control. 0d = Digital volume is muted 1d = Digital volume control is set to -100 dB 2d = Digital volume control is set to -99.5 dB 3d to 200d = Digital volume control is set as per configuration 201d = Digital volume control is set to 0 dB 202d = Digital volume control is set to 0.5 dB 203d to 253d = Digital volume control is set as per configuration 254d = Digital volume control is set to 26.5 dB 255d = Digital volume control is set to 27 dB |

7.6.1.1.66 CH8_CFG3 Register (page = 0x00, address = 0x62) [reset = 80h]

This register is configuration register 3 for channel 8 (for the digital microphone PDM input only).

図 7-138. CH8_CFG3 Register

| 7 | 6 | 5 | 4 | 3 | 2 | 1 | 0 |
|---------------|---|---|---|----------|---|---|---|
| CH8_GCAL[3:0] | | | | Reserved | | | |
| R/W-8h | | | | R-0h | | | |

表 7-120. CH8_CFG3 Register Field Descriptions

| Bit | Field | Type | Reset | Description |
|-----|---------------|------|-------|--|
| 7-4 | CH8_GCAL[3:0] | R/W | 8h | Channel 8 gain calibration. 0d = Gain calibration is set to -0.8 dB 1d = Gain calibration is set to -0.7 dB 2d = Gain calibration is set to -0.6 dB 3d to 7d = Gain calibration is set as per configuration 8d = Gain calibration is set to 0 dB 9d = Gain calibration is set to 0.1 dB 10d to 13d = Gain calibration is set as per configuration 14d = Gain calibration is set to 0.6 dB 15d = Gain calibration is set to 0.7 dB |
| 3-0 | Reserved | R | 0h | Reserved |

7.6.1.1.67 CH8_CFG4 Register (page = 0x00, address = 0x63) [reset = 0h]

This register is configuration register 4 for channel 8 (for the digital microphone PDM input only).

図 7-139. CH8_CFG4 Register

| 7 | 6 | 5 | 4 | 3 | 2 | 1 | 0 |
|---------------|---|---|---|---|---|---|---|
| CH8_PCAL[7:0] | | | | | | | |
| R/W-0h | | | | | | | |

表 7-121. CH8_CFG4 Register Field Descriptions

| Bit | Field | Type | Reset | Description |
|-----|---------------|------|-------|---|
| 7-0 | CH8_PCAL[7:0] | R/W | 0h | Channel 8 phase calibration with modulator clock resolution. 0d = No phase calibration 1d = Phase calibration delay is set to one cycle of the modulator clock 2d = Phase calibration delay is set to two cycles of the modulator clock 3d to 254d = Phase calibration delay as per configuration 255d = Phase calibration delay is set to 255 cycles of the modulator clock |

7.6.1.1.68 DSP_CFG0 Register (page = 0x00, address = 0x6B) [reset = 1h]

This register is the digital signal processor (DSP) configuration register 0.

図 7-140. DSP_CFG0 Register

| 7 | 6 | 5 | 4 | 3 | 2 | 1 | 0 |
|---|---|---|---|---|---|---|---|
|---|---|---|---|---|---|---|---|

☒ 7-140. DSP_CFG0 Register (続き)

| | | | |
|----------|----------------|-------------|--------------|
| Reserved | DECI_FILT[1:0] | CH_SUM[1:0] | HPF_SEL[1:0] |
| R-0h | R/W-0h | R/W-0h | R/W-1h |

表 7-122. DSP_CFG0 Register Field Descriptions

| Bit | Field | Type | Reset | Description |
|-----|----------------|------|-------|--|
| 7-6 | Reserved | R | 0h | Reserved |
| 5-4 | DECI_FILT[1:0] | R/W | 0h | Decimation filter response. 0d = Linear phase 1d = Low latency 2d = Ultra-low latency 3d = Reserved |
| 3-2 | CH_SUM[1:0] | R/W | 0h | Channel summation mode for higher SNR 0d = Channel summation mode is disabled 1d = 2-channel summation mode is enabled to generate a (CH1 + CH2) / 2 and a (CH3 + CH4) / 2 output 2d = 4-channel summation mode is enabled to generate a (CH1 + CH2 + CH3 + CH4) / 4 output 3d = Reserved |
| 1-0 | HPF_SEL[1:0] | R/W | 1h | High-pass filter (HPF) selection. 0d = Programmable first-order IIR filter for a custom HPF with default coefficient values in P4_R72 to P4_R83 set as the all-pass filter 1d = HPF with a cutoff of $0.00025 \times f_S$ (12 Hz at $f_S = 48$ kHz) is selected 2d = HPF with a cutoff of $0.002 \times f_S$ (96 Hz at $f_S = 48$ kHz) is selected 3d = HPF with a cutoff of $0.008 \times f_S$ (384 Hz at $f_S = 48$ kHz) is selected |

7.6.1.1.69 DSP_CFG1 Register (page = 0x00, address = 0x6C) [reset = 40h]

This register is the digital signal processor (DSP) configuration register 1.

☒ 7-141. DSP_CFG1 Register

| | | | | | | | |
|-----------|-----------------|---|-------------------|-------------|----------|---|---|
| 7 | 6 | 5 | 4 | 3 | 2 | 1 | 0 |
| DVOL_GANG | BIQUAD_CFG[1:0] | | DISABLE_SOFT_STEP | DRE_AGC_SEL | Reserved | | |
| R/W-0h | R/W-2h | | R/W-0h | R/W-0h | R/W-0h | | |

表 7-123. DSP_CFG1 Register Field Descriptions

| Bit | Field | Type | Reset | Description |
|-----|-------------------|------|-------|--|
| 7 | DVOL_GANG | R/W | 0h | DVOL control ganged across channels. 0d = Each channel has its own DVOL CTRL settings as programmed in the CHx_DVOL bits 1d = All active channels must use the channel 1 DVOL setting (CH1_DVOL) irrespective of whether channel 1 is turned on or not |
| 6-5 | BIQUAD_CFG[1:0] | R/W | 2h | Number of biquads per channel configuration. 0d = No biquads per channel; biquads are all disabled 1d = 1 biquad per channel 2d = 2 biquads per channel 3d = 3 biquads per channel |
| 4 | DISABLE_SOFT_STEP | R/W | 0h | Soft-stepping disable during DVOL change, mute, and unmute. 0d = Soft-stepping enabled 1d = Soft-stepping disabled |
| 3 | DRE_AGC_SEL | R/W | 0h | DRE or AGC selection when is enabled for any channel. 0d = DRE is selected 1d = AGC is selected |
| 2-0 | Reserved | R/W | 0h | Reserved |

7.6.1.1.70 DRE_CFG0 Register (page = 0x00, address = 0x6D) [reset = 7Bh]

This register is the dynamic range enhancer (DRE) configuration register 0.

 **7-142. DRE_CFG0 Register**

| | | | | | | | |
|--------------|---|---|---|------------------|---|---|---|
| 7 | 6 | 5 | 4 | 3 | 2 | 1 | 0 |
| DRE_LVL[3:0] | | | | DRE_MAXGAIN[3:0] | | | |
| R/W-7h | | | | R/W-Bh | | | |

表 7-124. DRE_CFG0 Register Field Descriptions

| Bit | Field | Type | Reset | Description |
|-----|------------------|------|-------|---|
| 7-4 | DRE_LVL[3:0] | R/W | 7h | DRE trigger signal level threshold. 0d = Input signal level threshold is –12 dB 1d = Input signal level threshold is –18 dB 2d = Input signal level threshold is –24 dB 3d to 6d = Input signal level threshold is as per configuration 7d = Input signal level threshold is –54 dB 8d = Input signal level threshold is –60 dB 9d = Input signal level threshold is –66 dB 10d to 15d = Reserved |
| 3-0 | DRE_MAXGAIN[3:0] | R/W | Bh | DRE maximum gain allowed. 0d = Maximum gain allowed is 2 dB 1d = Maximum gain allowed is 4 dB 2d = Maximum gain allowed is 6 dB 3d to 10d = Maximum gain allowed is as per configuration 11d = Maximum gain allowed is 24 dB 12d = Maximum gain allowed is 26 dB 13d to 15d = Reserved |

7.6.1.1.71 AGC_CFG0 Register (page = 0x00, address = 0x70) [reset = E7h]

This register is the automatic gain controller (AGC) configuration register 0.

 **7-143. AGC_CFG0 Register**

| | | | | | | | |
|--------------|---|---|---|------------------|---|---|---|
| 7 | 6 | 5 | 4 | 3 | 2 | 1 | 0 |
| AGC_LVL[3:0] | | | | AGC_MAXGAIN[3:0] | | | |
| R/W-Eh | | | | R/W-7h | | | |

表 7-125. AGC_CFG0 Register Field Descriptions

| Bit | Field | Type | Reset | Description |
|-----|------------------|------|-------|--|
| 7-4 | AGC_LVL[3:0] | R/W | Eh | AGC output signal target level. 0d = Output signal target level is –6 dB 1d = Output signal target level is –8 dB 2d = Output signal target level is –10 dB 3d to 13d = Output signal target level is as per configuration 14d = Output signal target level is –34 dB 15d = Output signal target level is –36 dB |
| 3-0 | AGC_MAXGAIN[3:0] | R/W | 7h | AGC maximum gain allowed. 0d = Maximum gain allowed is 3 dB 1d = Maximum gain allowed is 6 dB 2d = Maximum gain allowed is 9 dB 3d to 11d = Maximum gain allowed is as per configuration 12d = Maximum gain allowed is 39 dB 13d = Maximum gain allowed is 42 dB 14d to 15d = Reserved |

7.6.1.1.72 IN_CH_EN Register (page = 0x00, address = 0x73) [reset = F0h]

This register is the input channel enable configuration register.

 **7-144. IN_CH_EN Register**

| | | | | | | | |
|-----------|-----------|-----------|-----------|-----------|-----------|-----------|-----------|
| 7 | 6 | 5 | 4 | 3 | 2 | 1 | 0 |
| IN_CH1_EN | IN_CH2_EN | IN_CH3_EN | IN_CH4_EN | IN_CH5_EN | IN_CH6_EN | IN_CH7_EN | IN_CH8_EN |

図 7-144. IN_CH_EN Register (続き)

| | | | | | | | |
|--------|--------|--------|--------|--------|--------|--------|--------|
| R/W-1h | R/W-1h | R/W-1h | R/W-1h | R/W-0h | R/W-0h | R/W-0h | R/W-0h |
|--------|--------|--------|--------|--------|--------|--------|--------|

表 7-126. IN_CH_EN Register Field Descriptions

| Bit | Field | Type | Reset | Description |
|-----|-----------|------|-------|---|
| 7 | IN_CH1_EN | R/W | 1h | Input channel 1 enable setting. 0d = Channel 1 is disabled 1d = Channel 1 is enabled |
| 6 | IN_CH2_EN | R/W | 1h | Input channel 2 enable setting. 0d = Channel 2 is disabled 1d = Channel 2 is enabled |
| 5 | IN_CH3_EN | R/W | 1h | Input channel 3 enable setting. 0d = Channel 3 is disabled 1d = Channel 3 is enabled |
| 4 | IN_CH4_EN | R/W | 1h | Input channel 4 enable setting. 0d = Channel 4 is disabled 1d = Channel 4 is enabled |
| 3 | IN_CH5_EN | R/W | 0h | Input channel 5 (PDM only) enable setting. 0d = Channel 5 is disabled 1d = Channel 5 is enabled |
| 2 | IN_CH6_EN | R/W | 0h | Input channel 6 (PDM only) enable setting. 0d = Channel 6 is disabled 1d = Channel 6 is enabled |
| 1 | IN_CH7_EN | R/W | 0h | Input channel 7 (PDM only) enable setting. 0d = Channel 7 is disabled 1d = Channel 7 is enabled |
| 0 | IN_CH8_EN | R/W | 0h | Input channel 8 (PDM only) enable setting. 0d = Channel 8 is disabled 1d = Channel 8 is enabled |

7.6.1.1.73 ASI_OUT_CH_EN Register (page = 0x00, address = 0x74) [reset = 0h]

This register is the ASI output channel enable configuration register.

図 7-145. ASI_OUT_CH_EN Register

| | | | | | | | |
|----------------|----------------|----------------|----------------|----------------|----------------|----------------|----------------|
| 7 | 6 | 5 | 4 | 3 | 2 | 1 | 0 |
| ASI_OUT_CH1_EN | ASI_OUT_CH2_EN | ASI_OUT_CH3_EN | ASI_OUT_CH4_EN | ASI_OUT_CH5_EN | ASI_OUT_CH6_EN | ASI_OUT_CH7_EN | ASI_OUT_CH8_EN |
| R/W-0h | R/W-0h | R/W-0h | R/W-0h | R/W-0h | R/W-0h | R/W-0h | R/W-0h |

表 7-127. ASI_OUT_CH_EN Register Field Descriptions

| Bit | Field | Type | Reset | Description |
|-----|----------------|------|-------|---|
| 7 | ASI_OUT_CH1_EN | R/W | 0h | ASI output channel 1 enable setting. 0d = Channel 1 output slot is in a tri-state condition 1d = Channel 1 output slot is enabled |
| 6 | ASI_OUT_CH2_EN | R/W | 0h | ASI output channel 2 enable setting. 0d = Channel 2 output slot is in a tri-state condition 1d = Channel 2 output slot is enabled |
| 5 | ASI_OUT_CH3_EN | R/W | 0h | ASI output channel 3 enable setting. 0d = Channel 3 output slot is in a tri-state condition 1d = Channel 3 output slot is enabled |
| 4 | ASI_OUT_CH4_EN | R/W | 0h | ASI output channel 4 enable setting. 0d = Channel 4 output slot is in a tri-state condition 1d = Channel 4 output slot is enabled |
| 3 | ASI_OUT_CH5_EN | R/W | 0h | ASI output channel 5 enable setting. 0d = Channel 5 output slot is in a tri-state condition 1d = Channel 5 output slot is enabled |

表 7-127. ASI_OUT_CH_EN Register Field Descriptions (続き)

| Bit | Field | Type | Reset | Description |
|-----|----------------|------|-------|---|
| 2 | ASI_OUT_CH6_EN | R/W | 0h | ASI output channel 6 enable setting. 0d = Channel 6 output slot is in a tri-state condition 1d = Channel 6 output slot is enabled |
| 1 | ASI_OUT_CH7_EN | R/W | 0h | ASI output channel 7 enable setting. 0d = Channel 7 output slot is in a tri-state condition 1d = Channel 7 output slot is enabled |
| 0 | ASI_OUT_CH8_EN | R/W | 0h | ASI output channel 8 enable setting. 0d = Channel 8 output slot is in a tri-state condition 1d = Channel 8 output slot is enabled |

7.6.1.1.74 PWR_CFG Register (page = 0x00, address = 0x75) [reset = 0h]

This register is the power-up configuration register.

図 7-146. PWR_CFG Register

| 7 | 6 | 5 | 4 | 3 | 2 | 1 | 0 |
|-------------|---------|---------|----------------|--------------------|---|----------|---|
| MICBIAS_PDZ | ADC_PDZ | PLL_PDZ | DYN_CH_PUPD_EN | DYN_MAXCH_SEL[1:0] | | Reserved | |
| R/W-0h | R/W-0h | R/W-0h | R/W-0h | R/W-0h | | R/W-0h | |

表 7-128. PWR_CFG Register Field Descriptions

| Bit | Field | Type | Reset | Description |
|-----|--------------------|------|-------|---|
| 7 | MICBIAS_PDZ | R/W | 0h | Power control for MICBIAS. 0d = Power down MICBIAS 1d = Power up MICBIAS |
| 6 | ADC_PDZ | R/W | 0h | Power control for ADC and PDM channels. 0d = Power down all ADC and PDM channels 1d = Power up all enabled ADC and PDM channels |
| 5 | PLL_PDZ | R/W | 0h | Power control for the PLL. 0d = Power down the PLL 1d = Power up the PLL |
| 4 | DYN_CH_PUPD_EN | R/W | 0h | Dynamic channel power-up, power-down enable. 0d = Channel power-up, power-down is not supported if any channel recording is on 1d = Channel can be powered up or down individually, even if channel recording is on. Do not power down Channel 1 in this mode |
| 3-2 | DYN_MAXCH_SEL[1:0] | R/W | 0h | Dynamic mode maximum channel select configuration. 0d = Channel 1 and channel 2 are used with dynamic channel power-up, power-down feature enabled 1d = Channel 1 to channel 4 are used with dynamic channel power-up, power-down feature enabled 2d = Channel 1 to channel 6 are used with dynamic channel power-up, power-down feature enabled 3d = Channel 1 to channel 8 are used with dynamic channel power-up, power-down feature enabled |
| 1-0 | Reserved | R/W | 0h | Reserved |

7.6.1.1.75 DEV_STS0 Register (page = 0x00, address = 0x76) [reset = 0h]

This register is the device status value register 0.

図 7-147. DEV_STS0 Register

| 7 | 6 | 5 | 4 | 3 | 2 | 1 | 0 |
|------------|------------|------------|------------|------------|------------|------------|------------|
| CH1_STATUS | CH2_STATUS | CH3_STATUS | CH4_STATUS | CH5_STATUS | CH6_STATUS | CH7_STATUS | CH8_STATUS |
| R-0h | R-0h | R-0h | R-0h | R-0h | R-0h | R-0h | R-0h |

表 7-129. DEV_STS0 Register Field Descriptions

| Bit | Field | Type | Reset | Description |
|-----|------------|------|-------|--|
| 7 | CH1_STATUS | R | 0h | ADC or PDM channel 1 power status. 0d = ADC or PDM channel is powered down 1d = ADC or PDM channel is powered up |
| 6 | CH2_STATUS | R | 0h | ADC or PDM channel 2 power status. 0d = ADC or PDM channel is powered down 1d = ADC or PDM channel is powered up |
| 5 | CH3_STATUS | R | 0h | ADC or PDM channel 3 power status. 0d = ADC or PDM channel is powered down 1d = ADC or PDM channel is powered up |
| 4 | CH4_STATUS | R | 0h | ADC or PDM channel 4 power status. 0d = ADC or PDM channel is powered down 1d = ADC or PDM channel is powered up |
| 3 | CH5_STATUS | R | 0h | PDM channel 5 power status. 0d = PDM channel is powered down 1d = PDM channel is powered up |
| 2 | CH6_STATUS | R | 0h | PDM channel 6 power status. 0d = PDM channel is powered down 1d = PDM channel is powered up |
| 1 | CH7_STATUS | R | 0h | PDM channel 7 power status. 0d = PDM channel is powered down 1d = PDM channel is powered up |
| 0 | CH8_STATUS | R | 0h | PDM channel 8 power status. 0d = PDM channel is powered down 1d = PDM channel is powered up |

7.6.1.1.76 DEV_STS1 Register (page = 0x00, address = 0x77) [reset = 80h]

This register is the device status value register 1.

図 7-148. DEV_STS1 Register

| 7 | 6 | 5 | 4 | 3 | 2 | 1 | 0 |
|---------------|---|---|----------|---|---|---|---|
| MODE_STS[2:0] | | | Reserved | | | | |
| R-4h | | | R-0h | | | | |

表 7-130. DEV_STS1 Register Field Descriptions

| Bit | Field | Type | Reset | Description |
|-----|---------------|------|-------|--|
| 7-5 | MODE_STS[2:0] | R | 4h | Device mode status. 4d = Device is in sleep mode or software shutdown mode 6d = Device is in active mode with all ADC or PDM channels turned off 7d = Device is in active mode with at least one ADC or PDM channel turned on |
| 4-0 | Reserved | R | 0h | Reserved |

7.6.1.1.77 I2C_CKSUM Register (page = 0x00, address = 0x7E) [reset = 0h]

This register returns the I²C transactions checksum value.

図 7-149. I2C_CKSUM Register

| 7 | 6 | 5 | 4 | 3 | 2 | 1 | 0 |
|----------------|---|---|---|---|---|---|---|
| I2C_CKSUM[7:0] | | | | | | | |
| R/W-0h | | | | | | | |

表 7-131. I2C_CKSUM Register Field Descriptions

| Bit | Field | Type | Reset | Description |
|-----|----------------|------|-------|--|
| 7-0 | I2C_CKSUM[7:0] | R/W | 0h | These bits return the I ² C transactions checksum value. Writing to this register resets the checksum to the written value. This register is updated on writes to other registers on all pages. |

7.6.2 Programmable Coefficient Registers

7.6.2.1 Programmable Coefficient Registers: Page = 0x02

This register page (shown in 表 7-132) consists of the programmable coefficients for the biquad 1 to biquad 6 filters. To optimize the coefficients register transaction time for page 2, page 3, and page 4, the device also supports (by default) auto-incremented pages for the I²C and SPI burst writes and reads. After a transaction of register address 0x7F, the device auto increments to the next page at register 0x08 to transact the next coefficient value. These programmable coefficients are 32-bit, two's complement numbers. For a successful coefficient register transaction, the host device must write and read all the four bytes starting with the most significant byte (BYT1) for a target coefficient register transaction. While using SPI for a coefficient register read transaction, the device gives out first byte as dummy read byte therefore the host must read five bytes which includes first byte as dummy read byte and the last four bytes corresponds to the coefficient register value starting with the most significant byte (BYT1).

表 7-132. Page 0x02 Programmable Coefficient Registers

| ADDRESS | REGISTER | RESET | DESCRIPTION |
|---------|------------------|-------|---|
| 0x00 | PAGE[7:0] | 0x00 | Device page register |
| 0x08 | BQ1_N0_BYT1[7:0] | 0x7F | Programmable biquad 1, N0 coefficient byte[31:24] |
| 0x09 | BQ1_N0_BYT2[7:0] | 0xFF | Programmable biquad 1, N0 coefficient byte[23:16] |
| 0x0A | BQ1_N0_BYT3[7:0] | 0xFF | Programmable biquad 1, N0 coefficient byte[15:8] |
| 0x0B | BQ1_N0_BYT4[7:0] | 0xFF | Programmable biquad 1, N0 coefficient byte[7:0] |
| 0x0C | BQ1_N1_BYT1[7:0] | 0x00 | Programmable biquad 1, N1 coefficient byte[31:24] |
| 0x0D | BQ1_N1_BYT2[7:0] | 0x00 | Programmable biquad 1, N1 coefficient byte[23:16] |
| 0x0E | BQ1_N1_BYT3[7:0] | 0x00 | Programmable biquad 1, N1 coefficient byte[15:8] |
| 0x0F | BQ1_N1_BYT4[7:0] | 0x00 | Programmable biquad 1, N1 coefficient byte[7:0] |
| 0x10 | BQ1_N2_BYT1[7:0] | 0x00 | Programmable biquad 1, N2 coefficient byte[31:24] |
| 0x11 | BQ1_N2_BYT2[7:0] | 0x00 | Programmable biquad 1, N2 coefficient byte[23:16] |
| 0x12 | BQ1_N2_BYT3[7:0] | 0x00 | Programmable biquad 1, N2 coefficient byte[15:8] |
| 0x13 | BQ1_N2_BYT4[7:0] | 0x00 | Programmable biquad 1, N2 coefficient byte[7:0] |
| 0x14 | BQ1_D1_BYT1[7:0] | 0x00 | Programmable biquad 1, D1 coefficient byte[31:24] |
| 0x15 | BQ1_D1_BYT2[7:0] | 0x00 | Programmable biquad 1, D1 coefficient byte[23:16] |
| 0x16 | BQ1_D1_BYT3[7:0] | 0x00 | Programmable biquad 1, D1 coefficient byte[15:8] |
| 0x17 | BQ1_D1_BYT4[7:0] | 0x00 | Programmable biquad 1, D1 coefficient byte[7:0] |
| 0x18 | BQ1_D2_BYT1[7:0] | 0x00 | Programmable biquad 1, D2 coefficient byte[31:24] |
| 0x19 | BQ1_D2_BYT2[7:0] | 0x00 | Programmable biquad 1, D2 coefficient byte[23:16] |
| 0x1A | BQ1_D2_BYT3[7:0] | 0x00 | Programmable biquad 1, D2 coefficient byte[15:8] |
| 0x1B | BQ1_D2_BYT4[7:0] | 0x00 | Programmable biquad 1, D2 coefficient byte[7:0] |
| 0x1C | BQ2_N0_BYT1[7:0] | 0x7F | Programmable biquad 2, N0 coefficient byte[31:24] |
| 0x1D | BQ2_N0_BYT2[7:0] | 0xFF | Programmable biquad 2, N0 coefficient byte[23:16] |
| 0x1E | BQ2_N0_BYT3[7:0] | 0xFF | Programmable biquad 2, N0 coefficient byte[15:8] |
| 0x1F | BQ2_N0_BYT4[7:0] | 0xFF | Programmable biquad 2, N0 coefficient byte[7:0] |
| 0x20 | BQ2_N1_BYT1[7:0] | 0x00 | Programmable biquad 2, N1 coefficient byte[31:24] |
| 0x21 | BQ2_N1_BYT2[7:0] | 0x00 | Programmable biquad 2, N1 coefficient byte[23:16] |
| 0x22 | BQ2_N1_BYT3[7:0] | 0x00 | Programmable biquad 2, N1 coefficient byte[15:8] |
| 0x23 | BQ2_N1_BYT4[7:0] | 0x00 | Programmable biquad 2, N1 coefficient byte[7:0] |
| 0x24 | BQ2_N2_BYT1[7:0] | 0x00 | Programmable biquad 2, N2 coefficient byte[31:24] |
| 0x25 | BQ2_N2_BYT2[7:0] | 0x00 | Programmable biquad 2, N2 coefficient byte[23:16] |
| 0x26 | BQ2_N2_BYT3[7:0] | 0x00 | Programmable biquad 2, N2 coefficient byte[15:8] |
| 0x27 | BQ2_N2_BYT4[7:0] | 0x00 | Programmable biquad 2, N2 coefficient byte[7:0] |
| 0x28 | BQ2_D1_BYT1[7:0] | 0x00 | Programmable biquad 2, D1 coefficient byte[31:24] |
| 0x29 | BQ2_D1_BYT2[7:0] | 0x00 | Programmable biquad 2, D1 coefficient byte[23:16] |
| 0x2A | BQ2_D1_BYT3[7:0] | 0x00 | Programmable biquad 2, D1 coefficient byte[15:8] |

表 7-132. Page 0x02 Programmable Coefficient Registers (続き)

| | | | |
|------|------------------|------|---|
| 0x2B | BQ2_D1_BYT4[7:0] | 0x00 | Programmable biquad 2, D1 coefficient byte[7:0] |
| 0x2C | BQ2_D2_BYT1[7:0] | 0x00 | Programmable biquad 2, D2 coefficient byte[31:24] |
| 0x2D | BQ2_D2_BYT2[7:0] | 0x00 | Programmable biquad 2, D2 coefficient byte[23:16] |
| 0x2E | BQ2_D2_BYT3[7:0] | 0x00 | Programmable biquad 2, D2 coefficient byte[15:8] |
| 0x2F | BQ2_D2_BYT4[7:0] | 0x00 | Programmable biquad 2, D2 coefficient byte[7:0] |
| 0x30 | BQ3_N0_BYT1[7:0] | 0x7F | Programmable biquad 3, N0 coefficient byte[31:24] |
| 0x31 | BQ3_N0_BYT2[7:0] | 0xFF | Programmable biquad 3, N0 coefficient byte[23:16] |
| 0x32 | BQ3_N0_BYT3[7:0] | 0xFF | Programmable biquad 3, N0 coefficient byte[15:8] |
| 0x33 | BQ3_N0_BYT4[7:0] | 0xFF | Programmable biquad 3, N0 coefficient byte[7:0] |
| 0x34 | BQ3_N1_BYT1[7:0] | 0x00 | Programmable biquad 3, N1 coefficient byte[31:24] |
| 0x35 | BQ3_N1_BYT2[7:0] | 0x00 | Programmable biquad 3, N1 coefficient byte[23:16] |
| 0x36 | BQ3_N1_BYT3[7:0] | 0x00 | Programmable biquad 3, N1 coefficient byte[15:8] |
| 0x37 | BQ3_N1_BYT4[7:0] | 0x00 | Programmable biquad 3, N1 coefficient byte[7:0] |
| 0x38 | BQ3_N2_BYT1[7:0] | 0x00 | Programmable biquad 3, N2 coefficient byte[31:24] |
| 0x39 | BQ3_N2_BYT2[7:0] | 0x00 | Programmable biquad 3, N2 coefficient byte[23:16] |
| 0x3A | BQ3_N2_BYT3[7:0] | 0x00 | Programmable biquad 3, N2 coefficient byte[15:8] |
| 0x3B | BQ3_N2_BYT4[7:0] | 0x00 | Programmable biquad 3, N2 coefficient byte[7:0] |
| 0x3C | BQ3_D1_BYT1[7:0] | 0x00 | Programmable biquad 3, D1 coefficient byte[31:24] |
| 0x3D | BQ3_D1_BYT2[7:0] | 0x00 | Programmable biquad 3, D1 coefficient byte[23:16] |
| 0x3E | BQ3_D1_BYT3[7:0] | 0x00 | Programmable biquad 3, D1 coefficient byte[15:8] |
| 0x3F | BQ3_D1_BYT4[7:0] | 0x00 | Programmable biquad 3, D1 coefficient byte[7:0] |
| 0x40 | BQ3_D2_BYT1[7:0] | 0x00 | Programmable biquad 3, D2 coefficient byte[31:24] |
| 0x41 | BQ3_D2_BYT2[7:0] | 0x00 | Programmable biquad 3, D2 coefficient byte[23:16] |
| 0x42 | BQ3_D2_BYT3[7:0] | 0x00 | Programmable biquad 3, D2 coefficient byte[15:8] |
| 0x43 | BQ3_D2_BYT4[7:0] | 0x00 | Programmable biquad 3, D2 coefficient byte[7:0] |
| 0x44 | BQ4_N0_BYT1[7:0] | 0x7F | Programmable biquad 4, N0 coefficient byte[31:24] |
| 0x45 | BQ4_N0_BYT2[7:0] | 0xFF | Programmable biquad 4, N0 coefficient byte[23:16] |
| 0x46 | BQ4_N0_BYT3[7:0] | 0xFF | Programmable biquad 4, N0 coefficient byte[15:8] |
| 0x47 | BQ4_N0_BYT4[7:0] | 0xFF | Programmable biquad 4, N0 coefficient byte[7:0] |
| 0x48 | BQ4_N1_BYT1[7:0] | 0x00 | Programmable biquad 4, N1 coefficient byte[31:24] |
| 0x49 | BQ4_N1_BYT2[7:0] | 0x00 | Programmable biquad 4, N1 coefficient byte[23:16] |
| 0x4A | BQ4_N1_BYT3[7:0] | 0x00 | Programmable biquad 4, N1 coefficient byte[15:8] |
| 0x4B | BQ4_N1_BYT4[7:0] | 0x00 | Programmable biquad 4, N1 coefficient byte[7:0] |
| 0x4C | BQ4_N2_BYT1[7:0] | 0x00 | Programmable biquad 4, N2 coefficient byte[31:24] |
| 0x4D | BQ4_N2_BYT2[7:0] | 0x00 | Programmable biquad 4, N2 coefficient byte[23:16] |
| 0x4E | BQ4_N2_BYT3[7:0] | 0x00 | Programmable biquad 4, N2 coefficient byte[15:8] |
| 0x4F | BQ4_N2_BYT4[7:0] | 0x00 | Programmable biquad 4, N2 coefficient byte[7:0] |
| 0x50 | BQ4_D1_BYT1[7:0] | 0x00 | Programmable biquad 4, D1 coefficient byte[31:24] |
| 0x51 | BQ4_D1_BYT2[7:0] | 0x00 | Programmable biquad 4, D1 coefficient byte[23:16] |
| 0x52 | BQ4_D1_BYT3[7:0] | 0x00 | Programmable biquad 4, D1 coefficient byte[15:8] |
| 0x53 | BQ4_D1_BYT4[7:0] | 0x00 | Programmable biquad 4, D1 coefficient byte[7:0] |
| 0x54 | BQ4_D2_BYT1[7:0] | 0x00 | Programmable biquad 4, D2 coefficient byte[31:24] |
| 0x55 | BQ4_D2_BYT2[7:0] | 0x00 | Programmable biquad 4, D2 coefficient byte[23:16] |
| 0x56 | BQ4_D2_BYT3[7:0] | 0x00 | Programmable biquad 4, D2 coefficient byte[15:8] |
| 0x57 | BQ4_D2_BYT4[7:0] | 0x00 | Programmable biquad 4, D2 coefficient byte[7:0] |
| 0x58 | BQ5_N0_BYT1[7:0] | 0x7F | Programmable biquad 5, N0 coefficient byte[31:24] |
| 0x59 | BQ5_N0_BYT2[7:0] | 0xFF | Programmable biquad 5, N0 coefficient byte[23:16] |
| 0x5A | BQ5_N0_BYT3[7:0] | 0xFF | Programmable biquad 5, N0 coefficient byte[15:8] |
| 0x5B | BQ5_N0_BYT4[7:0] | 0xFF | Programmable biquad 5, N0 coefficient byte[7:0] |
| 0x5C | BQ5_N1_BYT1[7:0] | 0x00 | Programmable biquad 5, N1 coefficient byte[31:24] |

表 7-132. Page 0x02 Programmable Coefficient Registers (続き)

| | | | |
|------|------------------|------|---|
| 0x5D | BQ5_N1_BYT2[7:0] | 0x00 | Programmable biquad 5, N1 coefficient byte[23:16] |
| 0x5E | BQ5_N1_BYT3[7:0] | 0x00 | Programmable biquad 5, N1 coefficient byte[15:8] |
| 0x5F | BQ5_N1_BYT4[7:0] | 0x00 | Programmable biquad 5, N1 coefficient byte[7:0] |
| 0x60 | BQ5_N2_BYT1[7:0] | 0x00 | Programmable biquad 5, N2 coefficient byte[31:24] |
| 0x61 | BQ5_N2_BYT2[7:0] | 0x00 | Programmable biquad 5, N2 coefficient byte[23:16] |
| 0x62 | BQ5_N2_BYT3[7:0] | 0x00 | Programmable biquad 5, N2 coefficient byte[15:8] |
| 0x63 | BQ5_N2_BYT4[7:0] | 0x00 | Programmable biquad 5, N2 coefficient byte[7:0] |
| 0x64 | BQ5_D1_BYT1[7:0] | 0x00 | Programmable biquad 5, D1 coefficient byte[31:24] |
| 0x65 | BQ5_D1_BYT2[7:0] | 0x00 | Programmable biquad 5, D1 coefficient byte[23:16] |
| 0x66 | BQ5_D1_BYT3[7:0] | 0x00 | Programmable biquad 5, D1 coefficient byte[15:8] |
| 0x67 | BQ5_D1_BYT4[7:0] | 0x00 | Programmable biquad 5, D1 coefficient byte[7:0] |
| 0x68 | BQ5_D2_BYT1[7:0] | 0x00 | Programmable biquad 5, D2 coefficient byte[31:24] |
| 0x69 | BQ5_D2_BYT2[7:0] | 0x00 | Programmable biquad 5, D2 coefficient byte[23:16] |
| 0x6A | BQ5_D2_BYT3[7:0] | 0x00 | Programmable biquad 5, D2 coefficient byte[15:8] |
| 0x6B | BQ5_D2_BYT4[7:0] | 0x00 | Programmable biquad 5, D2 coefficient byte[7:0] |
| 0x6C | BQ6_N0_BYT1[7:0] | 0x7F | Programmable biquad 6, N0 coefficient byte[31:24] |
| 0x6D | BQ6_N0_BYT2[7:0] | 0xFF | Programmable biquad 6, N0 coefficient byte[23:16] |
| 0x6E | BQ6_N0_BYT3[7:0] | 0xFF | Programmable biquad 6, N0 coefficient byte[15:8] |
| 0x6F | BQ6_N0_BYT4[7:0] | 0xFF | Programmable biquad 6, N0 coefficient byte[7:0] |
| 0x70 | BQ6_N1_BYT1[7:0] | 0x00 | Programmable biquad 6, N1 coefficient byte[31:24] |
| 0x71 | BQ6_N1_BYT2[7:0] | 0x00 | Programmable biquad 6, N1 coefficient byte[23:16] |
| 0x72 | BQ6_N1_BYT3[7:0] | 0x00 | Programmable biquad 6, N1 coefficient byte[15:8] |
| 0x73 | BQ6_N1_BYT4[7:0] | 0x00 | Programmable biquad 6, N1 coefficient byte[7:0] |
| 0x74 | BQ6_N2_BYT1[7:0] | 0x00 | Programmable biquad 6, N2 coefficient byte[31:24] |
| 0x75 | BQ6_N2_BYT2[7:0] | 0x00 | Programmable biquad 6, N2 coefficient byte[23:16] |
| 0x76 | BQ6_N2_BYT3[7:0] | 0x00 | Programmable biquad 6, N2 coefficient byte[15:8] |
| 0x77 | BQ6_N2_BYT4[7:0] | 0x00 | Programmable biquad 6, N2 coefficient byte[7:0] |
| 0x78 | BQ6_D1_BYT1[7:0] | 0x00 | Programmable biquad 6, D1 coefficient byte[31:24] |
| 0x79 | BQ6_D1_BYT2[7:0] | 0x00 | Programmable biquad 6, D1 coefficient byte[23:16] |
| 0x7A | BQ6_D1_BYT3[7:0] | 0x00 | Programmable biquad 6, D1 coefficient byte[15:8] |
| 0x7B | BQ6_D1_BYT4[7:0] | 0x00 | Programmable biquad 6, D1 coefficient byte[7:0] |
| 0x7C | BQ6_D2_BYT1[7:0] | 0x00 | Programmable biquad 6, D2 coefficient byte[31:24] |
| 0x7D | BQ6_D2_BYT2[7:0] | 0x00 | Programmable biquad 6, D2 coefficient byte[23:16] |
| 0x7E | BQ6_D2_BYT3[7:0] | 0x00 | Programmable biquad 6, D2 coefficient byte[15:8] |
| 0x7F | BQ6_D2_BYT4[7:0] | 0x00 | Programmable biquad 6, D2 coefficient byte[7:0] |

7.6.2.2 Programmable Coefficient Registers: Page = 0x03

This register page (shown in 表 7-133) consists of the programmable coefficients for the biquad 7 to biquad 12 filters. To optimize the coefficients register transaction time for page 2, page 3, and page 4, the device also supports (by default) auto-incremented pages for the I²C and SPI burst writes and reads. After a transaction of register address 0x7F, the device auto increments to the next page at register 0x08 to transact the next coefficient value. These programmable coefficients are 32-bit, two's complement numbers. For a successful coefficient register transaction, the host device must write and read all the four bytes starting with the most significant byte (BYT1) for a target coefficient register transaction. While using SPI for a coefficient register read transaction, the device gives out first byte as dummy read byte therefore the host must read five bytes which includes first byte as dummy read byte and the last four bytes corresponds to the coefficient register value starting with the most significant byte (BYT1).

表 7-133. Page 0x03 Programmable Coefficient Registers

| ADDR | REGISTER | RESET | DESCRIPTION |
|------|------------------|-------|---|
| 0x00 | PAGE[7:0] | 0x00 | Device page register |
| 0x08 | BQ7_N0_BYT1[7:0] | 0x7F | Programmable biquad 7, N0 coefficient byte[31:24] |
| 0x09 | BQ7_N0_BYT2[7:0] | 0xFF | Programmable biquad 7, N0 coefficient byte[23:16] |
| 0x0A | BQ7_N0_BYT3[7:0] | 0xFF | Programmable biquad 7, N0 coefficient byte[15:8] |
| 0x0B | BQ7_N0_BYT4[7:0] | 0xFF | Programmable biquad 7, N0 coefficient byte[7:0] |
| 0x0C | BQ7_N1_BYT1[7:0] | 0x00 | Programmable biquad 7, N1 coefficient byte[31:24] |
| 0x0D | BQ7_N1_BYT2[7:0] | 0x00 | Programmable biquad 7, N1 coefficient byte[23:16] |
| 0x0E | BQ7_N1_BYT3[7:0] | 0x00 | Programmable biquad 7, N1 coefficient byte[15:8] |
| 0x0F | BQ7_N1_BYT4[7:0] | 0x00 | Programmable biquad 7, N1 coefficient byte[7:0] |
| 0x10 | BQ7_N2_BYT1[7:0] | 0x00 | Programmable biquad 7, N2 coefficient byte[31:24] |
| 0x11 | BQ7_N2_BYT2[7:0] | 0x00 | Programmable biquad 7, N2 coefficient byte[23:16] |
| 0x12 | BQ7_N2_BYT3[7:0] | 0x00 | Programmable biquad 7, N2 coefficient byte[15:8] |
| 0x13 | BQ7_N2_BYT4[7:0] | 0x00 | Programmable biquad 7, N2 coefficient byte[7:0] |
| 0x14 | BQ7_D1_BYT1[7:0] | 0x00 | Programmable biquad 7, D1 coefficient byte[31:24] |
| 0x15 | BQ7_D1_BYT2[7:0] | 0x00 | Programmable biquad 7, D1 coefficient byte[23:16] |
| 0x16 | BQ7_D1_BYT3[7:0] | 0x00 | Programmable biquad 7, D1 coefficient byte[15:8] |
| 0x17 | BQ7_D1_BYT4[7:0] | 0x00 | Programmable biquad 7, D1 coefficient byte[7:0] |
| 0x18 | BQ7_D2_BYT1[7:0] | 0x00 | Programmable biquad 7, D2 coefficient byte[31:24] |
| 0x19 | BQ7_D2_BYT2[7:0] | 0x00 | Programmable biquad 7, D2 coefficient byte[23:16] |
| 0x1A | BQ7_D2_BYT3[7:0] | 0x00 | Programmable biquad 7, D2 coefficient byte[15:8] |
| 0x1B | BQ7_D2_BYT4[7:0] | 0x00 | Programmable biquad 7, D2 coefficient byte[7:0] |
| 0x1C | BQ8_N0_BYT1[7:0] | 0x7F | Programmable biquad 8, N0 coefficient byte[31:24] |
| 0x1D | BQ8_N0_BYT2[7:0] | 0xFF | Programmable biquad 8, N0 coefficient byte[23:16] |
| 0x1E | BQ8_N0_BYT3[7:0] | 0xFF | Programmable biquad 8, N0 coefficient byte[15:8] |
| 0x1F | BQ8_N0_BYT4[7:0] | 0xFF | Programmable biquad 8, N0 coefficient byte[7:0] |
| 0x20 | BQ8_N1_BYT1[7:0] | 0x00 | Programmable biquad 8, N1 coefficient byte[31:24] |
| 0x21 | BQ8_N1_BYT2[7:0] | 0x00 | Programmable biquad 8, N1 coefficient byte[23:16] |
| 0x22 | BQ8_N1_BYT3[7:0] | 0x00 | Programmable biquad 8, N1 coefficient byte[15:8] |
| 0x23 | BQ8_N1_BYT4[7:0] | 0x00 | Programmable biquad 8, N1 coefficient byte[7:0] |
| 0x24 | BQ8_N2_BYT1[7:0] | 0x00 | Programmable biquad 8, N2 coefficient byte[31:24] |
| 0x25 | BQ8_N2_BYT2[7:0] | 0x00 | Programmable biquad 8, N2 coefficient byte[23:16] |
| 0x26 | BQ8_N2_BYT3[7:0] | 0x00 | Programmable biquad 8, N2 coefficient byte[15:8] |
| 0x27 | BQ8_N2_BYT4[7:0] | 0x00 | Programmable biquad 8, N2 coefficient byte[7:0] |
| 0x28 | BQ8_D1_BYT1[7:0] | 0x00 | Programmable biquad 8, D1 coefficient byte[31:24] |
| 0x29 | BQ8_D1_BYT2[7:0] | 0x00 | Programmable biquad 8, D1 coefficient byte[23:16] |
| 0x2A | BQ8_D1_BYT3[7:0] | 0x00 | Programmable biquad 8, D1 coefficient byte[15:8] |
| 0x2B | BQ8_D1_BYT4[7:0] | 0x00 | Programmable biquad 8, D1 coefficient byte[7:0] |
| 0x2C | BQ8_D2_BYT1[7:0] | 0x00 | Programmable biquad 8, D2 coefficient byte[31:24] |

表 7-133. Page 0x03 Programmable Coefficient Registers (続き)

| | | | |
|------|-------------------|------|--|
| 0x2D | BQ8_D2_BYT2[7:0] | 0x00 | Programmable biquad 8, D2 coefficient byte[23:16] |
| 0x2E | BQ8_D2_BYT3[7:0] | 0x00 | Programmable biquad 8, D2 coefficient byte[15:8] |
| 0x2F | BQ8_D2_BYT4[7:0] | 0x00 | Programmable biquad 8, D2 coefficient byte[7:0] |
| 0x30 | BQ9_N0_BYT1[7:0] | 0x7F | Programmable biquad 9, N0 coefficient byte[31:24] |
| 0x31 | BQ9_N0_BYT2[7:0] | 0xFF | Programmable biquad 9, N0 coefficient byte[23:16] |
| 0x32 | BQ9_N0_BYT3[7:0] | 0xFF | Programmable biquad 9, N0 coefficient byte[15:8] |
| 0x33 | BQ9_N0_BYT4[7:0] | 0xFF | Programmable biquad 9, N0 coefficient byte[7:0] |
| 0x34 | BQ9_N1_BYT1[7:0] | 0x00 | Programmable biquad 9, N1 coefficient byte[31:24] |
| 0x35 | BQ9_N1_BYT2[7:0] | 0x00 | Programmable biquad 9, N1 coefficient byte[23:16] |
| 0x36 | BQ9_N1_BYT3[7:0] | 0x00 | Programmable biquad 9, N1 coefficient byte[15:8] |
| 0x37 | BQ9_N1_BYT4[7:0] | 0x00 | Programmable biquad 9, N1 coefficient byte[7:0] |
| 0x38 | BQ9_N2_BYT1[7:0] | 0x00 | Programmable biquad 9, N2 coefficient byte[31:24] |
| 0x39 | BQ9_N2_BYT2[7:0] | 0x00 | Programmable biquad 9, N2 coefficient byte[23:16] |
| 0x3A | BQ9_N2_BYT3[7:0] | 0x00 | Programmable biquad 9, N2 coefficient byte[15:8] |
| 0x3B | BQ9_N2_BYT4[7:0] | 0x00 | Programmable biquad 9, N2 coefficient byte[7:0] |
| 0x3C | BQ9_D1_BYT1[7:0] | 0x00 | Programmable biquad 9, D1 coefficient byte[31:24] |
| 0x3D | BQ9_D1_BYT2[7:0] | 0x00 | Programmable biquad 9, D1 coefficient byte[23:16] |
| 0x3E | BQ9_D1_BYT3[7:0] | 0x00 | Programmable biquad 9, D1 coefficient byte[15:8] |
| 0x3F | BQ9_D1_BYT4[7:0] | 0x00 | Programmable biquad 9, D1 coefficient byte[7:0] |
| 0x40 | BQ9_D2_BYT1[7:0] | 0x00 | Programmable biquad 9, D2 coefficient byte[31:24] |
| 0x41 | BQ9_D2_BYT2[7:0] | 0x00 | Programmable biquad 9, D2 coefficient byte[23:16] |
| 0x42 | BQ9_D2_BYT3[7:0] | 0x00 | Programmable biquad 9, D2 coefficient byte[15:8] |
| 0x43 | BQ9_D2_BYT4[7:0] | 0x00 | Programmable biquad 9, D2 coefficient byte[7:0] |
| 0x44 | BQ10_N0_BYT1[7:0] | 0x7F | Programmable biquad 10, N0 coefficient byte[31:24] |
| 0x45 | BQ10_N0_BYT2[7:0] | 0xFF | Programmable biquad 10, N0 coefficient byte[23:16] |
| 0x46 | BQ10_N0_BYT3[7:0] | 0xFF | Programmable biquad 10, N0 coefficient byte[15:8] |
| 0x47 | BQ10_N0_BYT4[7:0] | 0xFF | Programmable biquad 10, N0 coefficient byte[7:0] |
| 0x48 | BQ10_N1_BYT1[7:0] | 0x00 | Programmable biquad 10, N1 coefficient byte[31:24] |
| 0x49 | BQ10_N1_BYT2[7:0] | 0x00 | Programmable biquad 10, N1 coefficient byte[23:16] |
| 0x4A | BQ10_N1_BYT3[7:0] | 0x00 | Programmable biquad 10, N1 coefficient byte[15:8] |
| 0x4B | BQ10_N1_BYT4[7:0] | 0x00 | Programmable biquad 10, N1 coefficient byte[7:0] |
| 0x4C | BQ10_N2_BYT1[7:0] | 0x00 | Programmable biquad 10, N2 coefficient byte[31:24] |
| 0x4D | BQ10_N2_BYT2[7:0] | 0x00 | Programmable biquad 10, N2 coefficient byte[23:16] |
| 0x4E | BQ10_N2_BYT3[7:0] | 0x00 | Programmable biquad 10, N2 coefficient byte[15:8] |
| 0x4F | BQ10_N2_BYT4[7:0] | 0x00 | Programmable biquad 10, N2 coefficient byte[7:0] |
| 0x50 | BQ10_D1_BYT1[7:0] | 0x00 | Programmable biquad 10, D1 coefficient byte[31:24] |
| 0x51 | BQ10_D1_BYT2[7:0] | 0x00 | Programmable biquad 10, D1 coefficient byte[23:16] |
| 0x52 | BQ10_D1_BYT3[7:0] | 0x00 | Programmable biquad 10, D1 coefficient byte[15:8] |
| 0x53 | BQ10_D1_BYT4[7:0] | 0x00 | Programmable biquad 10, D1 coefficient byte[7:0] |
| 0x54 | BQ10_D2_BYT1[7:0] | 0x00 | Programmable biquad 10, D2 coefficient byte[31:24] |
| 0x55 | BQ10_D2_BYT2[7:0] | 0x00 | Programmable biquad 10, D2 coefficient byte[23:16] |
| 0x56 | BQ10_D2_BYT3[7:0] | 0x00 | Programmable biquad 10, D2 coefficient byte[15:8] |
| 0x57 | BQ10_D2_BYT4[7:0] | 0x00 | Programmable biquad 10, D2 coefficient byte[7:0] |
| 0x58 | BQ11_N0_BYT1[7:0] | 0x7F | Programmable biquad 11, N0 coefficient byte[31:24] |
| 0x59 | BQ11_N0_BYT2[7:0] | 0xFF | Programmable biquad 11, N0 coefficient byte[23:16] |
| 0x5A | BQ11_N0_BYT3[7:0] | 0xFF | Programmable biquad 11, N0 coefficient byte[15:8] |
| 0x5B | BQ11_N0_BYT4[7:0] | 0xFF | Programmable biquad 11, N0 coefficient byte[7:0] |
| 0x5C | BQ11_N1_BYT1[7:0] | 0x00 | Programmable biquad 11, N1 coefficient byte[31:24] |
| 0x5D | BQ11_N1_BYT2[7:0] | 0x00 | Programmable biquad 11, N1 coefficient byte[23:16] |
| 0x5E | BQ11_N1_BYT3[7:0] | 0x00 | Programmable biquad 11, N1 coefficient byte[15:8] |

表 7-133. Page 0x03 Programmable Coefficient Registers (続き)

| | | | |
|------|-------------------|------|--|
| 0x5F | BQ11_N1_BYT4[7:0] | 0x00 | Programmable biquad 11, N1 coefficient byte[7:0] |
| 0x60 | BQ11_N2_BYT1[7:0] | 0x00 | Programmable biquad 11, N2 coefficient byte[31:24] |
| 0x61 | BQ11_N2_BYT2[7:0] | 0x00 | Programmable biquad 11, N2 coefficient byte[23:16] |
| 0x62 | BQ11_N2_BYT3[7:0] | 0x00 | Programmable biquad 11, N2 coefficient byte[15:8] |
| 0x63 | BQ11_N2_BYT4[7:0] | 0x00 | Programmable biquad 11, N2 coefficient byte[7:0] |
| 0x64 | BQ11_D1_BYT1[7:0] | 0x00 | Programmable biquad 11, D1 coefficient byte[31:24] |
| 0x65 | BQ11_D1_BYT2[7:0] | 0x00 | Programmable biquad 11, D1 coefficient byte[23:16] |
| 0x66 | BQ11_D1_BYT3[7:0] | 0x00 | Programmable biquad 11, D1 coefficient byte[15:8] |
| 0x67 | BQ11_D1_BYT4[7:0] | 0x00 | Programmable biquad 11, D1 coefficient byte[7:0] |
| 0x68 | BQ11_D2_BYT1[7:0] | 0x00 | Programmable biquad 11, D2 coefficient byte[31:24] |
| 0x69 | BQ11_D2_BYT2[7:0] | 0x00 | Programmable biquad 11, D2 coefficient byte[23:16] |
| 0x6A | BQ11_D2_BYT3[7:0] | 0x00 | Programmable biquad 11, D2 coefficient byte[15:8] |
| 0x6B | BQ11_D2_BYT4[7:0] | 0x00 | Programmable biquad 11, D2 coefficient byte[7:0] |
| 0x6C | BQ12_N0_BYT1[7:0] | 0x7F | Programmable biquad 12, N0 coefficient byte[31:24] |
| 0x6D | BQ12_N0_BYT2[7:0] | 0xFF | Programmable biquad 12, N0 coefficient byte[23:16] |
| 0x6E | BQ12_N0_BYT3[7:0] | 0xFF | Programmable biquad 12, N0 coefficient byte[15:8] |
| 0x6F | BQ12_N0_BYT4[7:0] | 0xFF | Programmable biquad 12, N0 coefficient byte[7:0] |
| 0x70 | BQ12_N1_BYT1[7:0] | 0x00 | Programmable biquad 12, N1 coefficient byte[31:24] |
| 0x71 | BQ12_N1_BYT2[7:0] | 0x00 | Programmable biquad 12, N1 coefficient byte[23:16] |
| 0x72 | BQ12_N1_BYT3[7:0] | 0x00 | Programmable biquad 12, N1 coefficient byte[15:8] |
| 0x73 | BQ12_N1_BYT4[7:0] | 0x00 | Programmable biquad 12, N1 coefficient byte[7:0] |
| 0x74 | BQ12_N2_BYT1[7:0] | 0x00 | Programmable biquad 12, N2 coefficient byte[31:24] |
| 0x75 | BQ12_N2_BYT2[7:0] | 0x00 | Programmable biquad 12, N2 coefficient byte[23:16] |
| 0x76 | BQ12_N2_BYT3[7:0] | 0x00 | Programmable biquad 12, N2 coefficient byte[15:8] |
| 0x77 | BQ12_N2_BYT4[7:0] | 0x00 | Programmable biquad 12, N2 coefficient byte[7:0] |
| 0x78 | BQ12_D1_BYT1[7:0] | 0x00 | Programmable biquad 12, D1 coefficient byte[31:24] |
| 0x79 | BQ12_D1_BYT2[7:0] | 0x00 | Programmable biquad 12, D1 coefficient byte[23:16] |
| 0x7A | BQ12_D1_BYT3[7:0] | 0x00 | Programmable biquad 12, D1 coefficient byte[15:8] |
| 0x7B | BQ12_D1_BYT4[7:0] | 0x00 | Programmable biquad 12, D1 coefficient byte[7:0] |
| 0x7C | BQ12_D2_BYT1[7:0] | 0x00 | Programmable biquad 12, D2 coefficient byte[31:24] |
| 0x7D | BQ12_D2_BYT2[7:0] | 0x00 | Programmable biquad 12, D2 coefficient byte[23:16] |
| 0x7E | BQ12_D2_BYT3[7:0] | 0x00 | Programmable biquad 12, D2 coefficient byte[15:8] |
| 0x7F | BQ12_D2_BYT4[7:0] | 0x00 | Programmable biquad 12, D2 coefficient byte[7:0] |

7.6.2.3 Programmable Coefficient Registers: Page = 0x04

This register page (shown in 表 7-134) consists of the programmable coefficients for mixer 1 to mixer 4 and the first-order IIR filter. All mixer coefficients are 32-bit, two's complement numbers using a 1.31 number format. The value of 0x7FFFFFFF is equivalent to +1 (0-dB gain), the value 0x00000000 is equivalent to mute (zero data) and all values in between set the mixer attenuation computed using Equation 4. If the MSB is set to '1' then the attenuation remains the same but the signal phase is inverted. All IIR filter programmable coefficients are 32-bit, two's complement numbers. For a successful coefficient register transaction, the host device must write and read all the four bytes starting with the most significant byte (BYT1) for a target coefficient register transaction. While using SPI for a coefficient register read transaction, the device gives out first byte as dummy read byte therefore the host must read five bytes which includes first byte as dummy read byte and the last four bytes corresponds to the coefficient register value starting with the most significant byte (BYT1).

$$\text{hex2dec}(\text{value}) / 2^{31}$$

表 7-134. Page 0x04 Programmable Coefficient Registers

| ADDR | REGISTER | RESET | DESCRIPTION |
|------|--------------------|-------|--|
| 0x00 | PAGE[7:0] | 0x00 | Device page register |
| 0x08 | MIX1_CH1_BYT1[7:0] | 0x7F | Digital mixer 1, channel 1 coefficient byte[31:24] |
| 0x09 | MIX1_CH1_BYT2[7:0] | 0xFF | Digital mixer 1, channel 1 coefficient byte[23:16] |
| 0x0A | MIX1_CH1_BYT3[7:0] | 0xFF | Digital mixer 1, channel 1 coefficient byte[15:8] |
| 0x0B | MIX1_CH1_BYT4[7:0] | 0xFF | Digital mixer 1, channel 1 coefficient byte[7:0] |
| 0x0C | MIX1_CH2_BYT1[7:0] | 0x00 | Digital mixer 1, channel 2 coefficient byte[31:24] |
| 0x0D | MIX1_CH2_BYT2[7:0] | 0x00 | Digital mixer 1, channel 2 coefficient byte[23:16] |
| 0x0E | MIX1_CH2_BYT3[7:0] | 0x00 | Digital mixer 1, channel 2 coefficient byte[15:8] |
| 0x0F | MIX1_CH2_BYT4[7:0] | 0x00 | Digital mixer 1, channel 2 coefficient byte[7:0] |
| 0x10 | MIX1_CH3_BYT1[7:0] | 0x00 | Digital mixer 1, channel 3 coefficient byte[31:24] |
| 0x11 | MIX1_CH3_BYT2[7:0] | 0x00 | Digital mixer 1, channel 3 coefficient byte[23:16] |
| 0x12 | MIX1_CH3_BYT3[7:0] | 0x00 | Digital mixer 1, channel 3 coefficient byte[15:8] |
| 0x13 | MIX1_CH3_BYT4[7:0] | 0x00 | Digital mixer 1, channel 3 coefficient byte[7:0] |
| 0x14 | MIX1_CH4_BYT1[7:0] | 0x00 | Digital mixer 1, channel 4 coefficient byte[31:24] |
| 0x15 | MIX1_CH4_BYT2[7:0] | 0x00 | Digital mixer 1, channel 4 coefficient byte[23:16] |
| 0x16 | MIX1_CH4_BYT3[7:0] | 0x00 | Digital mixer 1, channel 4 coefficient byte[15:8] |
| 0x17 | MIX1_CH4_BYT4[7:0] | 0x00 | Digital mixer 1, channel 4 coefficient byte[7:0] |
| 0x18 | MIX2_CH1_BYT1[7:0] | 0x00 | Digital mixer 2, channel 1 coefficient byte[31:24] |
| 0x19 | MIX2_CH1_BYT2[7:0] | 0x00 | Digital mixer 2, channel 1 coefficient byte[23:16] |
| 0x1A | MIX2_CH1_BYT3[7:0] | 0x00 | Digital mixer 2, channel 1 coefficient byte[15:8] |
| 0x1B | MIX2_CH1_BYT4[7:0] | 0x00 | Digital mixer 2, channel 1 coefficient byte[7:0] |
| 0x1C | MIX2_CH2_BYT1[7:0] | 0x7F | Digital mixer 2, channel 2 coefficient byte[31:24] |
| 0x1D | MIX2_CH2_BYT2[7:0] | 0xFF | Digital mixer 2, channel 2 coefficient byte[23:16] |
| 0x1E | MIX2_CH2_BYT3[7:0] | 0xFF | Digital mixer 2, channel 2 coefficient byte[15:8] |
| 0x1F | MIX2_CH2_BYT4[7:0] | 0xFF | Digital mixer 2, channel 2 coefficient byte[7:0] |
| 0x20 | MIX2_CH3_BYT1[7:0] | 0x00 | Digital mixer 2, channel 3 coefficient byte[31:24] |
| 0x21 | MIX2_CH3_BYT2[7:0] | 0x00 | Digital mixer 2, channel 3 coefficient byte[23:16] |
| 0x22 | MIX2_CH3_BYT3[7:0] | 0x00 | Digital mixer 2, channel 3 coefficient byte[15:8] |
| 0x23 | MIX2_CH3_BYT4[7:0] | 0x00 | Digital mixer 2, channel 3 coefficient byte[7:0] |
| 0x24 | MIX2_CH4_BYT1[7:0] | 0x00 | Digital mixer 2, channel 4 coefficient byte[31:24] |
| 0x25 | MIX2_CH4_BYT2[7:0] | 0x00 | Digital mixer 2, channel 4 coefficient byte[23:16] |
| 0x26 | MIX2_CH4_BYT3[7:0] | 0x00 | Digital mixer 2, channel 4 coefficient byte[15:8] |
| 0x27 | MIX2_CH4_BYT4[7:0] | 0x00 | Digital mixer 2, channel 4 coefficient byte[7:0] |
| 0x28 | MIX3_CH1_BYT1[7:0] | 0x00 | Digital mixer 3, channel 1 coefficient byte[31:24] |
| 0x29 | MIX3_CH1_BYT2[7:0] | 0x00 | Digital mixer 3, channel 1 coefficient byte[23:16] |
| 0x2A | MIX3_CH1_BYT3[7:0] | 0x00 | Digital mixer 3, channel 1 coefficient byte[15:8] |

表 7-134. Page 0x04 Programmable Coefficient Registers (続き)

| | | | |
|------|--------------------|------|--|
| 0x2B | MIX3_CH1_BYT4[7:0] | 0x00 | Digital mixer 3, channel 1 coefficient byte[7:0] |
| 0x2C | MIX3_CH2_BYT1[7:0] | 0x00 | Digital mixer 3, channel 2 coefficient byte[31:24] |
| 0x2D | MIX3_CH2_BYT2[7:0] | 0x00 | Digital mixer 3, channel 2 coefficient byte[23:16] |
| 0x2E | MIX3_CH2_BYT3[7:0] | 0x00 | Digital mixer 3, channel 2 coefficient byte[15:8] |
| 0x2F | MIX3_CH2_BYT4[7:0] | 0x00 | Digital mixer 3, channel 2 coefficient byte[7:0] |
| 0x30 | MIX3_CH3_BYT1[7:0] | 0x7F | Digital mixer 3, channel 3 coefficient byte[31:24] |
| 0x31 | MIX3_CH3_BYT2[7:0] | 0xFF | Digital mixer 3, channel 3 coefficient byte[23:16] |
| 0x32 | MIX3_CH3_BYT3[7:0] | 0xFF | Digital mixer 3, channel 3 coefficient byte[15:8] |
| 0x33 | MIX3_CH3_BYT4[7:0] | 0xFF | Digital mixer 3, channel 3 coefficient byte[7:0] |
| 0x34 | MIX3_CH4_BYT1[7:0] | 0x00 | Digital mixer 3, channel 4 coefficient byte[31:24] |
| 0x35 | MIX3_CH4_BYT2[7:0] | 0x00 | Digital mixer 3, channel 4 coefficient byte[23:16] |
| 0x36 | MIX3_CH4_BYT3[7:0] | 0x00 | Digital mixer 3, channel 4 coefficient byte[15:8] |
| 0x37 | MIX3_CH4_BYT4[7:0] | 0x00 | Digital mixer 3, channel 4 coefficient byte[7:0] |
| 0x38 | MIX4_CH1_BYT1[7:0] | 0x00 | Digital mixer 4, channel 1 coefficient byte[31:24] |
| 0x39 | MIX4_CH1_BYT2[7:0] | 0x00 | Digital mixer 4, channel 1 coefficient byte[23:16] |
| 0x3A | MIX4_CH1_BYT3[7:0] | 0x00 | Digital mixer 4, channel 1 coefficient byte[15:8] |
| 0x3B | MIX4_CH1_BYT4[7:0] | 0x00 | Digital mixer 4, channel 1 coefficient byte[7:0] |
| 0x3C | MIX4_CH2_BYT1[7:0] | 0x00 | Digital mixer 4, channel 2 coefficient byte[31:24] |
| 0x3D | MIX4_CH2_BYT2[7:0] | 0x00 | Digital mixer 4, channel 2 coefficient byte[23:16] |
| 0x3E | MIX4_CH2_BYT3[7:0] | 0x00 | Digital mixer 4, channel 2 coefficient byte[15:8] |
| 0x3F | MIX4_CH2_BYT4[7:0] | 0x00 | Digital mixer 4, channel 2 coefficient byte[7:0] |
| 0x40 | MIX4_CH3_BYT1[7:0] | 0x00 | Digital mixer 4, channel 3 coefficient byte[31:24] |
| 0x41 | MIX4_CH3_BYT2[7:0] | 0x00 | Digital mixer 4, channel 3 coefficient byte[23:16] |
| 0x42 | MIX4_CH3_BYT3[7:0] | 0x00 | Digital mixer 4, channel 3 coefficient byte[15:8] |
| 0x43 | MIX4_CH3_BYT4[7:0] | 0x00 | Digital mixer 4, channel 3 coefficient byte[7:0] |
| 0x44 | MIX4_CH4_BYT1[7:0] | 0x7F | Digital mixer 4, channel 4 coefficient byte[31:24] |
| 0x45 | MIX4_CH4_BYT2[7:0] | 0xFF | Digital mixer 4, channel 4 coefficient byte[23:16] |
| 0x46 | MIX4_CH4_BYT3[7:0] | 0xFF | Digital mixer 4, channel 4 coefficient byte[15:8] |
| 0x47 | MIX4_CH4_BYT4[7:0] | 0xFF | Digital mixer 4, channel 4 coefficient byte[7:0] |
| 0x48 | IIR_N0_BYT1[7:0] | 0x7F | Programmable first-order IIR, N0 coefficient byte[31:24] |
| 0x49 | IIR_N0_BYT2[7:0] | 0xFF | Programmable first-order IIR, N0 coefficient byte[23:16] |
| 0x4A | IIR_N0_BYT3[7:0] | 0xFF | Programmable first-order IIR, N0 coefficient byte[15:8] |
| 0x4B | IIR_N0_BYT4[7:0] | 0xFF | Programmable first-order IIR, N0 coefficient byte[7:0] |
| 0x4C | IIR_N1_BYT1[7:0] | 0x00 | Programmable first-order IIR, N1 coefficient byte[31:24] |
| 0x4D | IIR_N1_BYT2[7:0] | 0x00 | Programmable first-order IIR, N1 coefficient byte[23:16] |
| 0x4E | IIR_N1_BYT3[7:0] | 0x00 | Programmable first-order IIR, N1 coefficient byte[15:8] |
| 0x4F | IIR_N1_BYT4[7:0] | 0x00 | Programmable first-order IIR, N1 coefficient byte[7:0] |
| 0x50 | IIR_D1_BYT1[7:0] | 0x00 | Programmable first-order IIR, D1 coefficient byte[31:24] |
| 0x51 | IIR_D1_BYT2[7:0] | 0x00 | Programmable first-order IIR, D1 coefficient byte[23:16] |
| 0x52 | IIR_D1_BYT3[7:0] | 0x00 | Programmable first-order IIR, D1 coefficient byte[15:8] |
| 0x53 | IIR_D1_BYT4[7:0] | 0x00 | Programmable first-order IIR, D1 coefficient byte[7:0] |

8 Application and Implementation

注

Information in the following applications sections is not part of the TI component specification, and TI does not warrant its accuracy or completeness. TI's customers are responsible for determining suitability of components for their purposes. Customers should validate and test their design implementation to confirm system functionality.

8.1 Application Information

The PCM5140-Q1 is a multichannel, high-performance audio analog-to-digital converter (ADC) that supports output sample rates of up to 768 kHz. The device supports either up to four analog microphones or up to eight digital pulse density modulation (PDM) microphones for simultaneous recording applications.

Communication to the PCM5140-Q1 for configuration of the control registers is supported using an I²C or SPI interface. The device supports a highly flexible, audio serial interface (TDM, I²S, and LJ) to transmit audio data seamlessly in the system across devices.

8.2 Typical Applications

8.2.1 Four-Channel Analog Microphone Recording

Figure 8-1 shows a typical configuration of the PCM5140-Q1 for an application using four analog microelectrical-mechanical system (MEMS) microphones for simultaneous recording operation with an I²C control interface and a time-division multiplexing (TDM) audio data target interface. For best distortion performance, use input AC-coupling capacitors with a low-voltage coefficient.

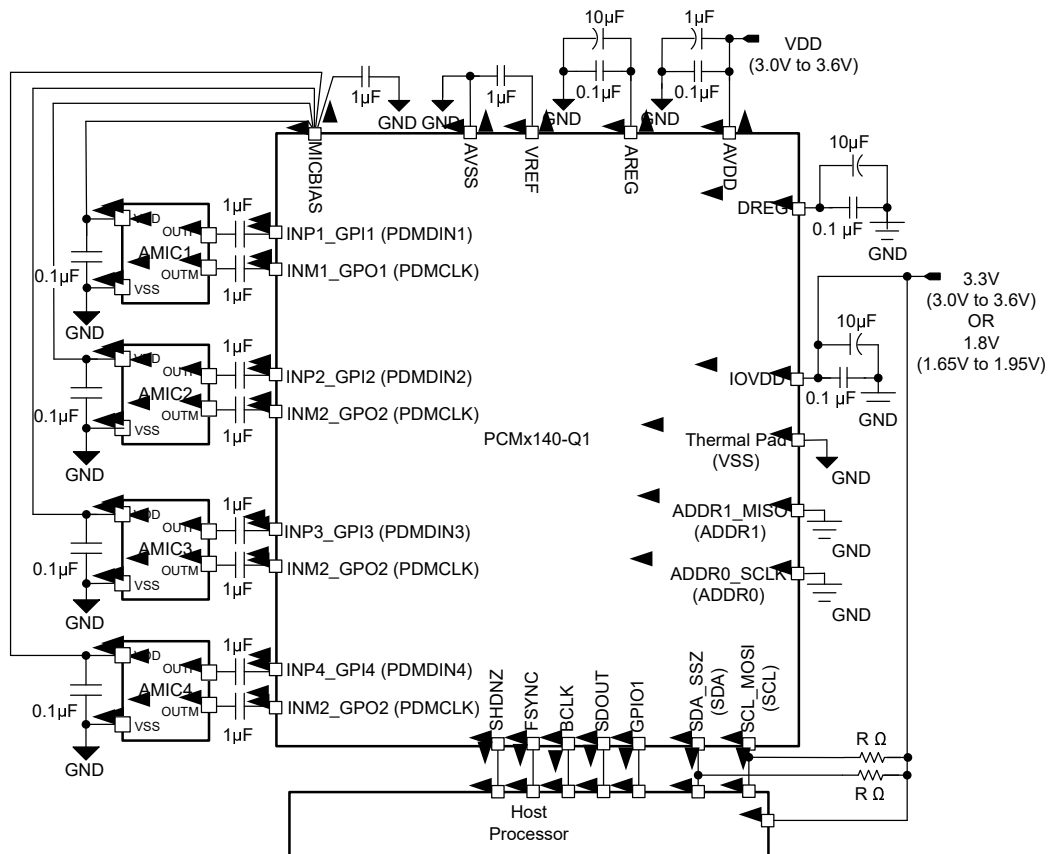

Figure 8-1. Four-Channel Analog Microphone Recording Diagram

8.2.1.1 Design Requirements

表 8-1 lists the design parameters for this application.

表 8-1. Design Parameters

| KEY PARAMETER | SPECIFICATION |
|---------------------------------|--|
| AVDD | 3.3 V |
| AVDD supply current consumption | > 23 mA (PLL on, four-channel recording, $f_s = 48$ kHz) |
| IOVDD | 1.8 V or 3.3 V |
| Maximum MICBIAS current | 10 mA (MICBIAS voltage is the same as AVDD) |

8.2.1.2 Detailed Design Procedure

This section describes the necessary steps to configure the PCM5140-Q1 for this specific application. The following steps provide a sequence of items that must be executed in the time between powering the device up and reading data from the device or transitioning from one mode to another mode of operation.

1. Apply power to the device:
 - a. Power-up the IOVDD and AVDD power supplies, keeping the SHDNZ pin voltage low
 - b. The device now goes into hardware shutdown mode (ultra-low-power mode < 1 μ A)
2. Transition from hardware shutdown mode to sleep mode (or software shutdown mode):
 - a. Release SHDNZ only when the IOVDD and AVDD power supplies settle to the steady-state operating voltage
 - b. Wait for at least 1 ms to allow the device to initialize the internal registers
 - c. The device now goes into sleep mode (low-power mode < 10 μ A)
3. Transition from sleep mode to active mode whenever required for the recording operation:
 - a. Wake up the device by writing to P0_R2 to disable sleep mode
 - b. Wait for at least 1 ms to allow the device to complete the internal wake-up sequence
 - c. Override default configuration registers or programmable coefficients value as required (this step is optional)
 - d. Enable all desired input channels by writing to P0_R115
 - e. Enable all desired audio serial interface output channels by writing to P0_R116
 - f. Power-up the ADC, MICBIAS, and PLL by writing to P0_R117
 - g. Apply FSYNC and BCLK with the desired output sample rates and the BCLK to FSYNC ratio
 This specific step can be done at any point in the sequence after step a.

See the [セクション 7.3.2](#) section for supported sample rates and the BCLK to FSYNC ratio.

- h. The device recording data are now sent to the host processor via the TDM audio serial data bus
4. Transition from active mode to sleep mode (again) as required in the system for low-power operation:
 - a. Enter sleep mode by writing to P0_R2 to enable sleep mode
 - b. Wait at least 6 ms (when FSYNC = 48 kHz) for the volume to ramp down and for all blocks to power down
 - c. Read P0_R119 to check the device shutdown and sleep mode status
 - d. If the device P0_R119_D7 status bit is 1'b1 then stop FSYNC and BCLK in the system
 - e. The device now goes into sleep mode (low-power mode < 10 μ A) and retains all register values
5. Transition from sleep mode to active mode (again) as required for the recording operation:
 - a. Wake up the device by writing to P0_R2 to disable sleep mode
 - b. Wait for at least 1 ms to allow the device to complete the internal wake-up sequence
 - c. Apply FSYNC and BCLK with the desired output sample rates and the BCLK to FSYNC ratio
 - d. The device recording data are now sent to the host processor via the TDM audio serial data bus
6. Repeat step 4 and step 5 as required for mode transitions
7. Assert the SHDNZ pin low to enter hardware shutdown mode (again) at any time
8. Follow step 2 onwards to exit hardware shutdown mode (again)

8.2.1.2.1 Example Device Register Configuration Script for EVM Setup

This section provides a typical EVM I²C register control script that shows how to set up the PCM5140-Q1 in a four-channel analog microphone recording mode with differential inputs.

```
# Key: w 98 XX YY ==> write to I2C address 0x98, to register 0xXX, data 0xYY
#           # ==> comment delimiter
#
# The following list gives an example sequence of items that must be executed in the time
# between powering the device up and reading data from the device. Note that there are
# other valid sequences depending on which features are used.
#
# See the PCM5140-Q1EVM user guide for jumper settings and audio connections.
#
# Differential 4-channel : INP1/INM1 - Ch1, INP2/INM2 - Ch2, INP3/INM3 - Ch3 and INP4/INM4 - Ch4
# FSYNC = 44.1 kHz (Output Data Sample Rate), BCLK = 11.2896 MHz (BCLK/FSYNC = 256)
#####
#
# Power up IOVDD and AVDD power supplies keeping SHDNZ pin voltage LOW
# wait for IOVDD and AVDD power supplies to settle to steady state operating voltage range.
# Release SHDNZ to HIGH.
# wait for 1ms.
#
# wake-up device by I2C write into P0_R2 using internal AREG
w 98 02 81
#
# Configure CH1_INSRC as analog Input by I2C write into P0_R60
w 98 3C 00
#
# Configure CH2_INSRC as analog Input by I2C write into P0_R65
w 98 41 00
#
# Configure CH3_INSRC as analog Input by I2C write into P0_R70
w 98 46 00
#
# Configure CH4_INSRC as analog Input by I2C write into P0_R75
w 98 4B 00
#
# Enable Input Ch-1 to Ch-4 by I2C write into P0_R115
w 98 73 F0
#
# Enable ASI Output Ch-1 to Ch-4 slots by I2C write into P0_R116
w 98 74 F0
#
# Power-up ADC, MICBIAS and PLL by I2C write into P0_R117
w 98 75 E0
#
# Apply FSYNC = 44.1 kHz and BCLK = 11.2896 MHz and
# Start recording data by host on ASI bus with TDM protocol 32-bits channel wordlength
```

8.2.1.3 Application Curves

Measurements are done on the EVM by feeding the device analog input signal using audio precision.

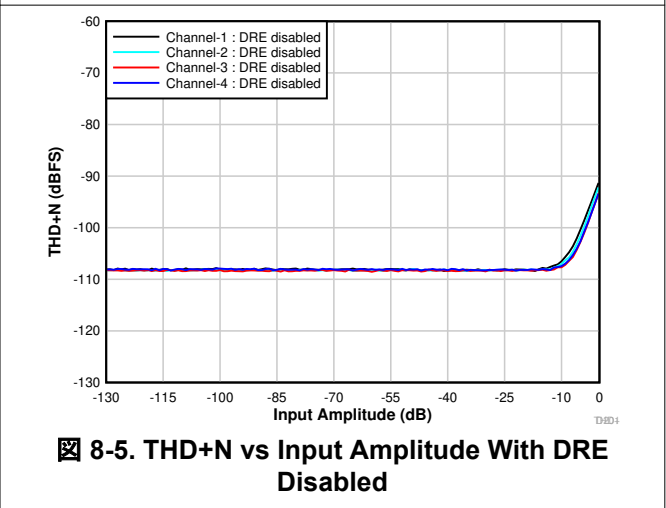
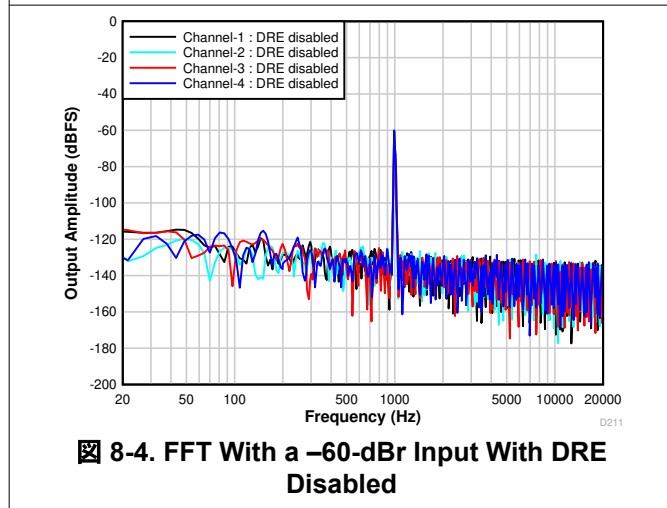
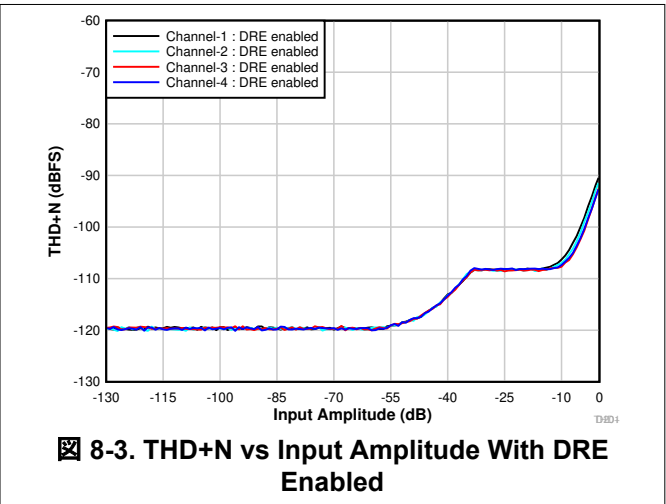
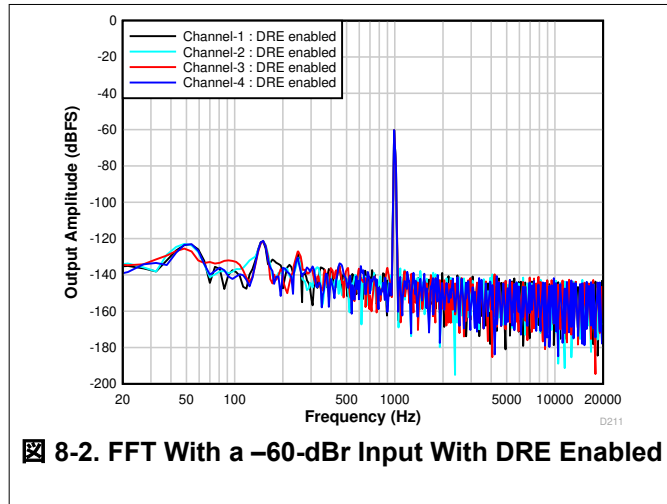

8.2.2 Eight-Channel Digital PDM Microphone Recording

Figure 8-1 shows a typical configuration of the PCM5140-Q1 for an application using eight digital PDM MEMS microphones with simultaneous recording operation using an I²C control interface and the TDM audio data target interface.

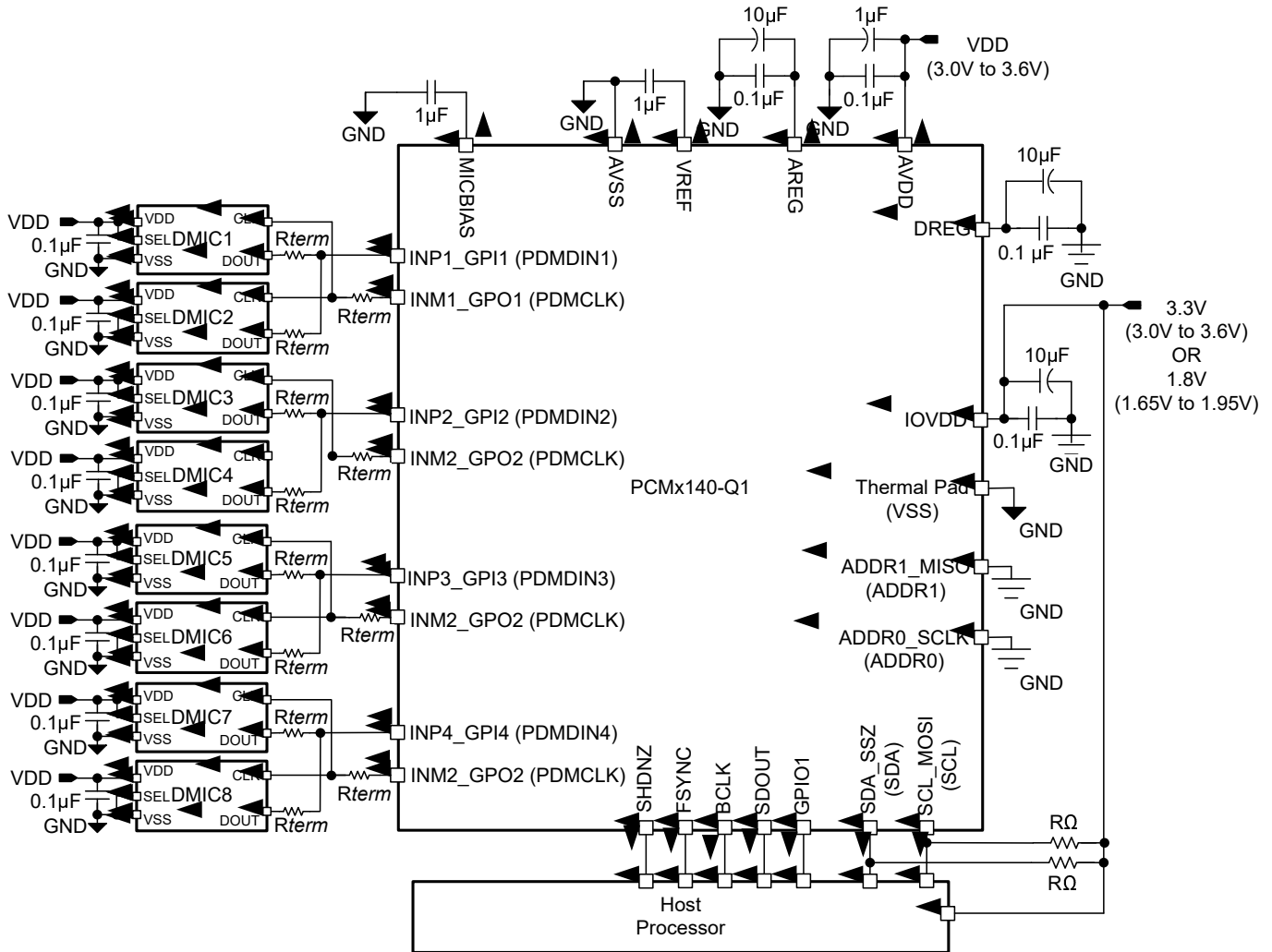

Figure 8-6. Eight-Channel Digital PDM Microphone Recording Diagram

8.2.2.1 Design Requirements

Table 8-2 lists the design parameters for this application.

Table 8-2. Design Parameters

| KEY PARAMETER | SPECIFICATION |
|---------------------------------|---|
| AVDD | 3.3 V |
| AVDD supply current consumption | 11.7 mA (PLL on, eight-channel recording, $f_s = 48$ kHz) |
| IOVDD | 1.8 V or 3.3 V |

8.2.2.2 Detailed Design Procedure

This section describes the necessary steps to configure the PCM5140-Q1 for this specific application. The following steps provide a sequence of items that must be executed in the time between powering the device up and reading data from the device or transitioning from one mode to another mode of operation.

1. Apply power to the device:
 - a. Power up the IOVDD and AVDD power supplies, keeping the SHDNZ pin voltage low
 - b. The device now goes into hardware shutdown mode (ultra-low-power mode < 1 μ A)
2. Transition from hardware shutdown mode to sleep mode (or software shutdown mode):
 - a. Release SHDNZ only when the IOVDD and AVDD power supplies settle to the steady-state operating voltage
 - b. Wait for at least 1 ms to allow the device to initialize the internal registers initialization
 - c. The device now goes into sleep mode (low-power mode < 10 μ A)
3. Transition from sleep mode to active mode whenever required for the recording operation:
 - a. Wake up the device by writing to P0_R2 to disable sleep mode
 - b. Wait for at least 1 ms to allow the device to complete the internal wake-up sequence
 - c. Override the default configuration registers or programmable coefficients value as required (this step is optional)
 - d. Configure channel 1 to channel 4 (CHx_INSRC) for the digital microphone as the input source for recording
 - e. Configure GPO1 to GPO4 (GPOx_CFG) as the PDMCLK output
 - f. Configure GPI1 to GPI4 (GPI1x_CFG) as PDMDIN1 to PDMDIN4, respectively
 - g. Enable all desired input channels by writing to P0_R115
 - h. Enable all desired audio serial interface output channels by writing to P0_R116
 - i. Power-up the ADC and PLL by writing to P0_R117
 - j. Apply FSYNC and BCLK with the desired output sample rates and the BCLK to FSYNC ratio

This specific step can be done at any point in the sequence after step a.

See the [セクション 7.3.2](#) section for supported sample rates and the BCLK to FSYNC ratio.

- k. The device recording data is now sent to the host processor using the TDM audio serial data bus
4. Transition from active mode to sleep mode (again) as required in the system for low-power operation:
 - a. Enter sleep mode by writing to P0_R2 to enable sleep mode
 - b. Wait at least 6 ms (when FSYNC = 48 kHz) for the volume to ramp down and for all blocks to power down
 - c. Read P0_R119 to check the device shutdown and sleep mode status
 - d. If the device P0_R119_D7 status bit is 1'b1 then stop FSYNC and BCLK in the system
 - e. The device now goes into sleep mode (low-power mode < 10 μ A) and retains all register values
5. Transition from sleep mode to active mode (again) as required for the recording operation:
 - a. Wake up the device by writing to P0_R2 to disable sleep mode
 - b. Wait at least 1 ms to allow the device to complete the internal wake-up sequence
 - c. Apply FSYNC and BCLK with the desired output sample rates and the BCLK to FSYNC ratio
 - d. The device recording data are now sent to the host processor using the TDM audio serial data bus
6. Repeat step 4 and step 5 as required for mode transitions
7. Assert the SHDNZ pin low to enter hardware shutdown mode (again) at any time
8. Follow step 2 onwards to exit hardware shutdown mode (again)

8.2.2.2.1 Example Device Register Configuration Script for EVM Setup

This section provides a typical EVM I²C register control script that shows how to set up the PCM5140-Q1 in an eight-channel digital PDM microphone recording mode.

```
# Key: w 98 XX YY ==> write to I2C address 0x98, to register 0xXX, data 0xYY
#           # ==> comment delimiter
#
# The following list gives an example sequence of items that must be executed in the time
# between powering the device up and reading data from the device. Note that there are
# other valid sequences depending on which features are used.
#
# See the PCM5140-Q1EVM user guide for jumper settings and audio connections.
#
# PDM 8-channel : PDMDIN1 - Ch1 and Ch2, PDMDIN2 - Ch3 and Ch4,
#                 PDMDIN3 - Ch5 and Ch6, PDMDIN4 - Ch7 and Ch8
# FSYNC = 44.1 kHz (Output Data Sample Rate), BCLK = 11.2896 MHz (BCLK/FSYNC = 256)
#####
#
# Power up IOVDD and AVDD power supplies keeping SHDNZ pin voltage LOW
# wait for IOVDD and AVDD power supplies to settle to steady state operating voltage range.
# Release SHDNZ to HIGH.
# wait for 1ms.
#
# Wake-up device by I2C write into P0_R2 using internal AREG
w 98 02 81
#
# Configure CH1_INSRC as Digital PDM Input by I2C write into P0_R60
w 98 3C 40
#
# Configure CH2_INSRC as Digital PDM Input by I2C write into P0_R65
w 98 41 40
#
# Configure CH3_INSRC as Digital PDM Input by I2C write into P0_R70
w 98 46 40
#
# Configure CH4_INSRC as Digital PDM Input by I2C write into P0_R75
w 98 4B 40
#
# Configure GPO1 as PDMCLK by I2C write into P0_R34
w 98 22 41
#
# Configure GPO2 as PDMCLK by I2C write into P0_R35
w 98 23 41
#
# Configure GPO3 as PDMCLK by I2C write into P0_R36
w 98 24 41
#
# Configure GPO4 as PDMCLK by I2C write into P0_R37
w 98 25 41
#
# Configure GPI1 and GPI2 as PDMDIN1 and PDMDIN2 by I2C write into P0_R43
w 98 2B 45
#
# Configure GPI3 and GPI4 as PDMDIN3 and PDMDIN4 by I2C write into P0_R44
w 98 2C 67
#
# Enable Input Ch-1 to Ch-8 by I2C write into P0_R115
w 98 73 FF
#
# Enable ASI Output Ch-1 to Ch-8 slots by I2C write into P0_R116
w 98 74 FF
#
# Power-up ADC and PLL by I2C write into P0_R117
w 98 75 60
#
# Apply FSYNC = 44.1 kHz and BCLK = 11.2896 MHz and
# Start recording data by host on ASI bus with TDM protocol 32-bits channel wordlength
```

8.3 What to Do and What Not to Do

8.3.1

In controller mode operation with I²S or LJ format, the device generates FSYNC half a cycle earlier than the normal protocol timing behavior expected. This timing behavior can still function for most of the system, however for further details and a suggested workaround for this weakness, see the [Configuring and Operating the TLV320ADCx140 as an Audio Bus target application report](#).

The automatic gain controller (AGC) feature has some limitation when using sampling rates lower than 44.1 kHz. For further details about this limitation, see the [Using the Automatic Gain Controller \(AGC\) in TLV320ADCx140 application report](#).

9 Power Supply Recommendations

The power-supply sequence between the IOVDD and AVDD rails can be applied in any order. However, keep the SHDNZ pin low until the IOVDD supply voltage settles to a stable and supported operating voltage range. After all supplies are stable, set the SHDNZ pin high to initialize the device.

For the supply power-up requirement, t_1 and t_2 must be at least 100 μ s. For the supply power-down requirement, t_3 and t_4 must be at least 10 ms. This timing (as shown in [Figure 9-1](#)) allows the device to ramp down the volume on the record data, power down the analog and digital blocks, and put the device into hardware shutdown mode. The device can also be immediately put into hardware shutdown mode from active mode if SHDNZ_CFG[1:0] is set to 2'b00 using the P0_R5_D[3:2] bits. In that case, t_3 and t_4 are required to be at least 100 μ s.

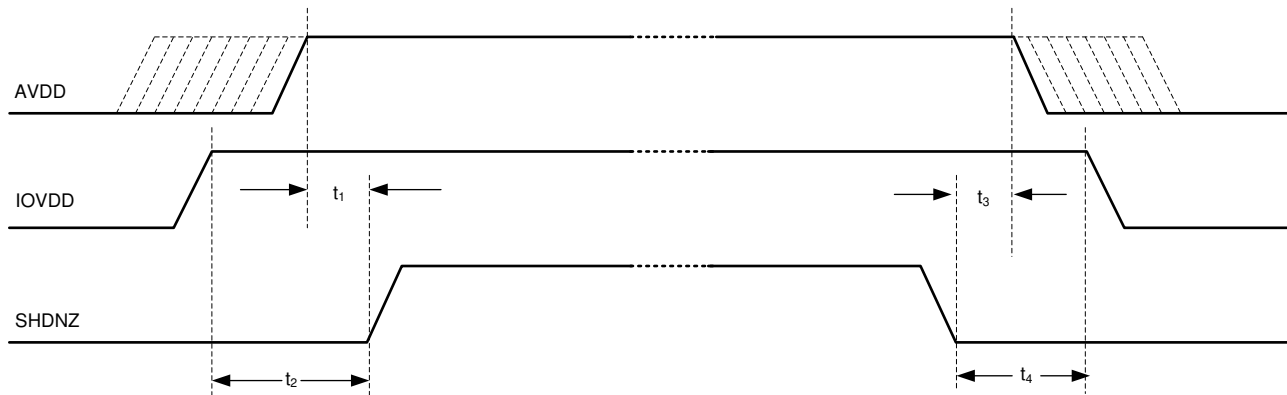

Figure 9-1. Power-Supply Sequencing Requirement Timing Diagram

Make sure that the supply ramp rate is slower than 1 V/ μ s and that the wait time between a power-down and a power-up event is at least 100 ms. For supply ramp rate slower than 0.1 V/ms, host device must apply a software reset as first transaction before doing any device configuration.

After releasing SHDNZ, or after a software reset, delay any additional I²C or SPI transactions to the device for at least 2 ms to allow the device to initialize the internal registers. See the [セクション 7.4](#) section for details on how the device operates in various modes after the device power supplies are settled to the recommended operating voltage levels.

The PCM5140-Q1 supports a single AVDD supply operation by integrating an on-chip digital regulator, DREG, and an analog regulator, AREG. However, if the AVDD voltage is less than 1.98 V in the system, then short the AREG and AVDD pins onboard and do not enable the internal AREG by keeping the AREG_SELECT bit to 1b'0 (default value) of P0_R2. If the AVDD supply used in the system is higher than 2.7 V, then the host device can set AREG_SELECT to 1'b1 while exiting sleep mode to allow the device internal regulator to generate the AREG supply.

10 Layout

10.1 Layout Guidelines

Each system design and printed circuit board (PCB) layout is unique. The layout must be carefully reviewed in the context of a specific PCB design. However, the following guidelines can optimize the device performance:

- Connect the thermal pad to ground. Use a via pattern to connect the device thermal pad, which is the area directly under the device, to the ground planes. This connection helps dissipate heat from the device.
- The decoupling capacitors for the power supplies must be placed close to the device pins.
- The supply decoupling capacitors must be used ceramic type with low ESR.

Input coupling capacitors must be film type for the best performance. See [Selecting Capacitors to Minimize Distortion in Audio Applications](#) for details on how input coupling capacitor type impacts THD+N performance.

- Route the analog differential audio signals differentially on the PCB for better noise immunity. Avoid crossing digital and analog signals to prevent undesirable crosstalk.
- The device internal voltage references must be filtered using external capacitors. Place the filter capacitors near the VREF pin for optimal performance.
- Directly tap the MICBIAS pin to avoid common impedance when routing the biasing or supply traces for multiple microphones to avoid coupling across microphones.
- Directly short the VREF and MICBIAS external capacitors ground terminal to the AVSS pin without using any vias for this connection trace.
- Place the MICBIAS capacitor (with low equivalent series resistance) close to the device with minimal trace impedance.
- Use ground planes to provide the lowest impedance for power and signal current between the device and the decoupling capacitors. Treat the area directly under the device as a central ground area for the device, and all device grounds must be connected directly to that area.

10.2 Layout Example

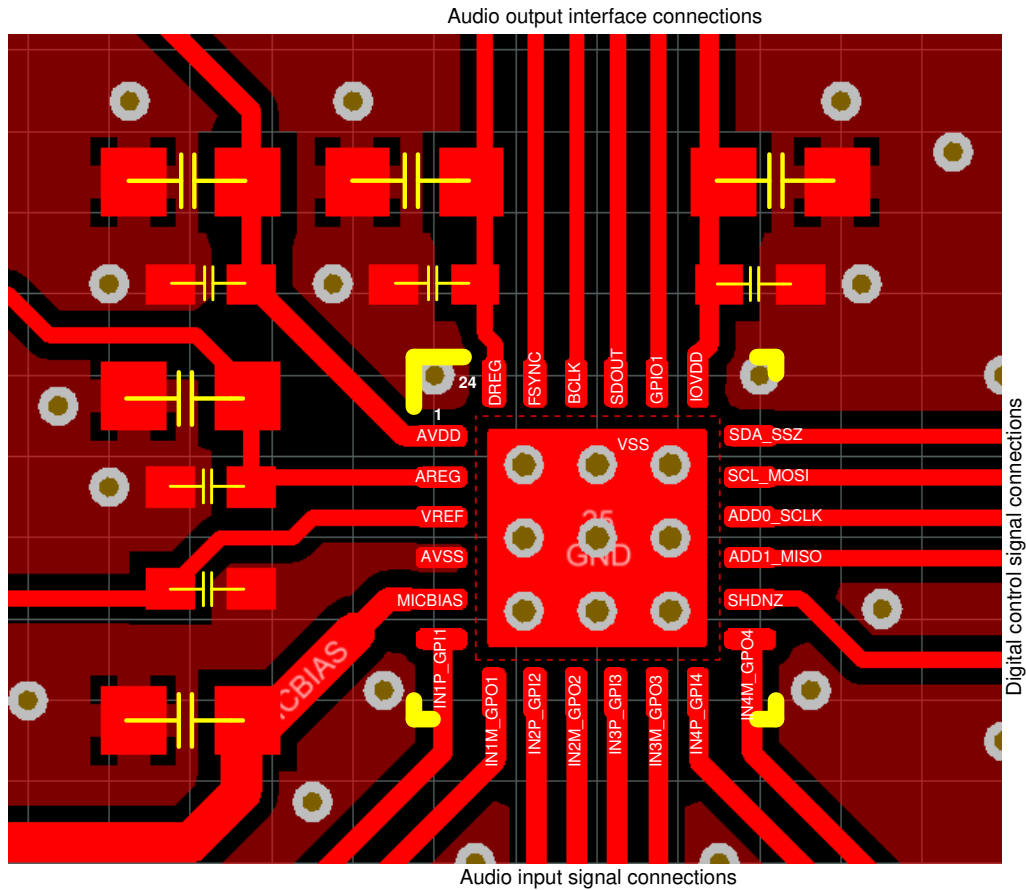

☒ 10-1. Layout Example

11 Device and Documentation Support

11.1 Documentation Support

11.1.1 Related Documentation

For related documentation see the following:

- Texas Instruments, [Multiple TLV320ADCx140 Devices With a Shared TDM and I²C Bus application report](#)
- Texas Instruments, [Configuring and Operating the TLV320ADCx140 as an Audio Bus Master application report](#)
- Texas Instruments, [TLV320ADCx140 Sampling Rates and Programmable Processing Blocks Supported application report](#)
- Texas Instruments, [TLV320ADCx140 Programmable Biquad Filter Configuration and Applications application report](#)
- Texas Instruments, [TLV320ADCx140 Power Consumption Matrix Across Various Usage Scenarios application report](#)
- Texas Instruments, [TLV320ADCx140 Integrated Analog Antialiasing Filter and Flexible Digital Filter application report](#)
- Texas Instruments, [Using the Automatic Gain Controller \(AGC\) in TLV320ADCx140 application report](#)
- Texas Instruments, [Using the Dynamic Range Enhancer \(DRE\) in TLV320ADC5140/6140 application report](#)
- Texas Instruments, [TLV320ADCx140 Evaluation module user's guide](#)
- Texas Instruments, [PurePath™ Console Graphical Development Suite for Audio System Design and Development](#)

11.2 ドキュメントの更新通知を受け取る方法

ドキュメントの更新についての通知を受け取るには、www.tij.co.jp のデバイス製品フォルダを開いてください。[通知] をクリックして登録すると、変更されたすべての製品情報に関するダイジェストを毎週受け取ることができます。変更の詳細については、改訂されたドキュメントに含まれている改訂履歴をご覧ください。

11.3 サポート・リソース

テキサス・インスツルメンツ E2E™ サポート・フォーラムは、エンジニアが検証済みの回答と設計に関するヒントをエキスパートから迅速かつ直接得ることができる場所です。既存の回答を検索したり、独自の質問をしたりすることで、設計に必要な支援を迅速に得ることができます。

リンクされているコンテンツは、各寄稿者により「現状のまま」提供されるものです。これらはテキサス・インスツルメンツの仕様を構成するものではなく、必ずしもテキサス・インスツルメンツの見解を反映したものではありません。テキサス・インスツルメンツの[使用条件](#)を参照してください。

11.4 Trademarks

Burr-Brown™, PurePath™, and テキサス・インスツルメンツ E2E™ are trademarks of Texas Instruments.

すべての商標は、それぞれの所有者に帰属します。

11.5 静電気放電に関する注意事項



この IC は、ESD によって破損する可能性があります。テキサス・インスツルメンツは、IC を取り扱う際には常に適切な注意を払うことを推奨します。正しい取り扱いおよび設置手順に従わない場合、デバイスを破損するおそれがあります。

ESD による破損は、わずかな性能低下からデバイスの完全な故障まで多岐にわたります。精密な IC の場合、パラメータがわずかに変化するだけで公表されている仕様から外れる可能性があるため、破損が発生しやすくなっています。

11.6 用語集

[テキサス・インスツルメンツ用語集](#) この用語集には、用語や略語の一覧および定義が記載されています。

12 Revision History

資料番号末尾の英字は改訂を表しています。その改訂履歴は英語版に準じています。

Changes from Revision * (December 2023) to Revision A (February 2024)

Page

- ドキュメントのステータスを「事前情報」から「量産データ」に変更..... [1](#)
-

13 Mechanical, Packaging, and Orderable Information

The following pages include mechanical, packaging, and orderable information. This information is the most current data available for the designated devices. This data is subject to change without notice and revision of this document. For browser-based versions of this data sheet, refer to the left-hand navigation.

PACKAGING INFORMATION

| Orderable Device | Status (1) | Package Type | Package Drawing | Pins | Package Qty | Eco Plan (2) | Lead finish/ Ball material (6) | MSL Peak Temp (3) | Op Temp (°C) | Device Marking (4/5) | Samples |
|------------------|---------------|--------------|-----------------|------|-------------|-----------------|--------------------------------------|----------------------|--------------|-------------------------|---------|
| PCM5140QRGERQ1 | ACTIVE | VQFN | RGE | 24 | 3000 | RoHS & Green | NIPDAU | Level-2-260C-1 YEAR | -40 to 125 | PCM5140 Q1 | Samples |

(1) The marketing status values are defined as follows:

ACTIVE: Product device recommended for new designs.

LIFEBUY: TI has announced that the device will be discontinued, and a lifetime-buy period is in effect.

NRND: Not recommended for new designs. Device is in production to support existing customers, but TI does not recommend using this part in a new design.

PREVIEW: Device has been announced but is not in production. Samples may or may not be available.

OBSOLETE: TI has discontinued the production of the device.

(2) **RoHS:** TI defines "RoHS" to mean semiconductor products that are compliant with the current EU RoHS requirements for all 10 RoHS substances, including the requirement that RoHS substance do not exceed 0.1% by weight in homogeneous materials. Where designed to be soldered at high temperatures, "RoHS" products are suitable for use in specified lead-free processes. TI may reference these types of products as "Pb-Free".

RoHS Exempt: TI defines "RoHS Exempt" to mean products that contain lead but are compliant with EU RoHS pursuant to a specific EU RoHS exemption.

Green: TI defines "Green" to mean the content of Chlorine (Cl) and Bromine (Br) based flame retardants meet JS709B low halogen requirements of <=1000ppm threshold. Antimony trioxide based flame retardants must also meet the <=1000ppm threshold requirement.

(3) MSL, Peak Temp. - The Moisture Sensitivity Level rating according to the JEDEC industry standard classifications, and peak solder temperature.

(4) There may be additional marking, which relates to the logo, the lot trace code information, or the environmental category on the device.

(5) Multiple Device Markings will be inside parentheses. Only one Device Marking contained in parentheses and separated by a "~" will appear on a device. If a line is indented then it is a continuation of the previous line and the two combined represent the entire Device Marking for that device.

(6) Lead finish/Ball material - Orderable Devices may have multiple material finish options. Finish options are separated by a vertical ruled line. Lead finish/Ball material values may wrap to two lines if the finish value exceeds the maximum column width.

Important Information and Disclaimer:The information provided on this page represents TI's knowledge and belief as of the date that it is provided. TI bases its knowledge and belief on information provided by third parties, and makes no representation or warranty as to the accuracy of such information. Efforts are underway to better integrate information from third parties. TI has taken and continues to take reasonable steps to provide representative and accurate information but may not have conducted destructive testing or chemical analysis on incoming materials and chemicals. TI and TI suppliers consider certain information to be proprietary, and thus CAS numbers and other limited information may not be available for release.

In no event shall TI's liability arising out of such information exceed the total purchase price of the TI part(s) at issue in this document sold by TI to Customer on an annual basis.

RGE 24

GENERIC PACKAGE VIEW

VQFN - 1 mm max height

PLASTIC QUAD FLATPACK - NO LEAD



Images above are just a representation of the package family, actual package may vary.
Refer to the product data sheet for package details.

4204104/H

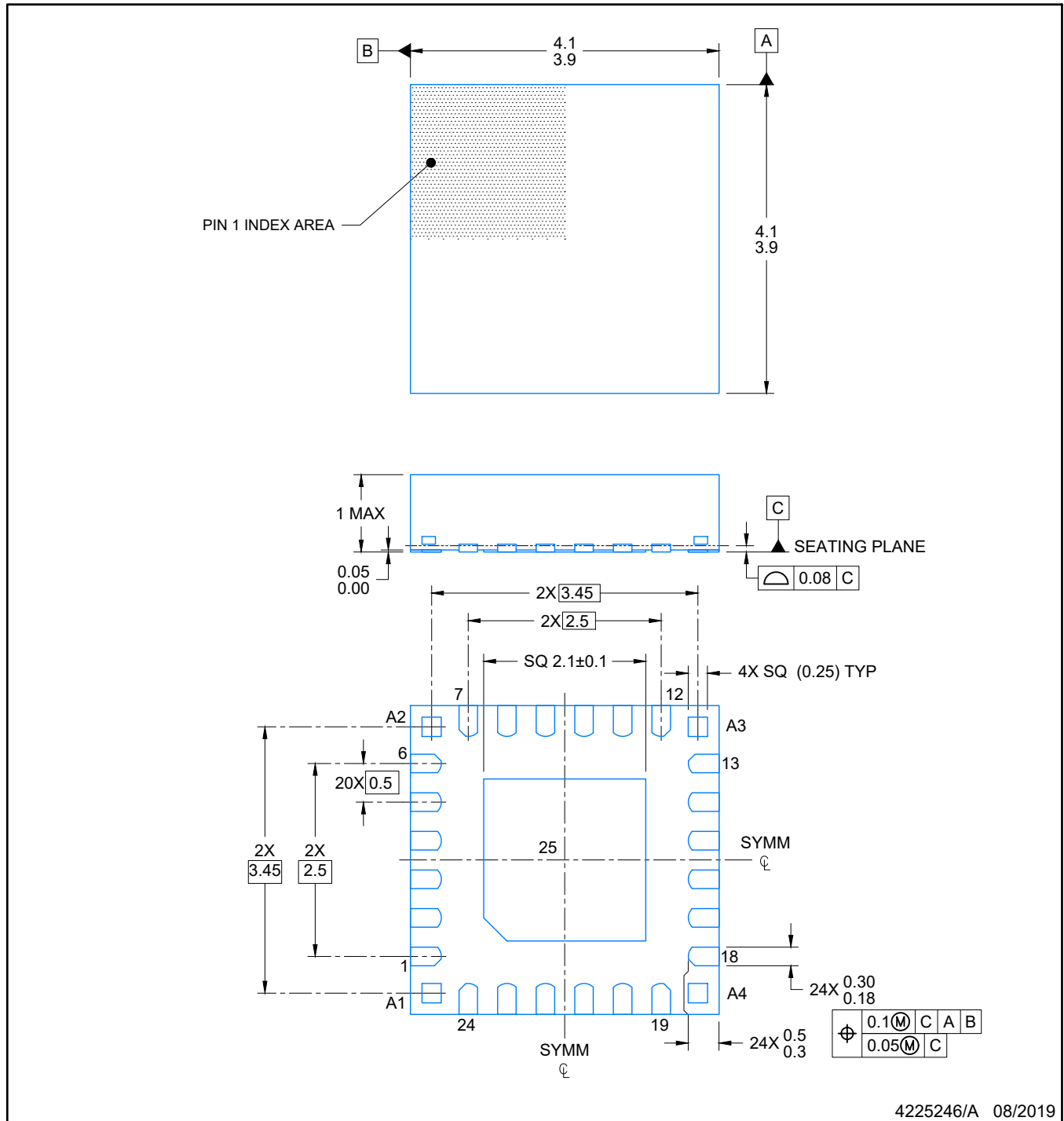

4225246/A 08/2019

NOTES:

1. All linear dimensions are in millimeters. Any dimensions in parenthesis are for reference only. Dimensioning and tolerancing per ASME Y14.5M.
2. This drawing is subject to change without notice.
3. The package thermal pad must be soldered to the printed circuit board for optimal thermal and mechanical performance.

EXAMPLE BOARD LAYOUT

RGE0024R

VQFN - 1 mm max height

PLASTIC QUAD FLATPACK-NO LEAD

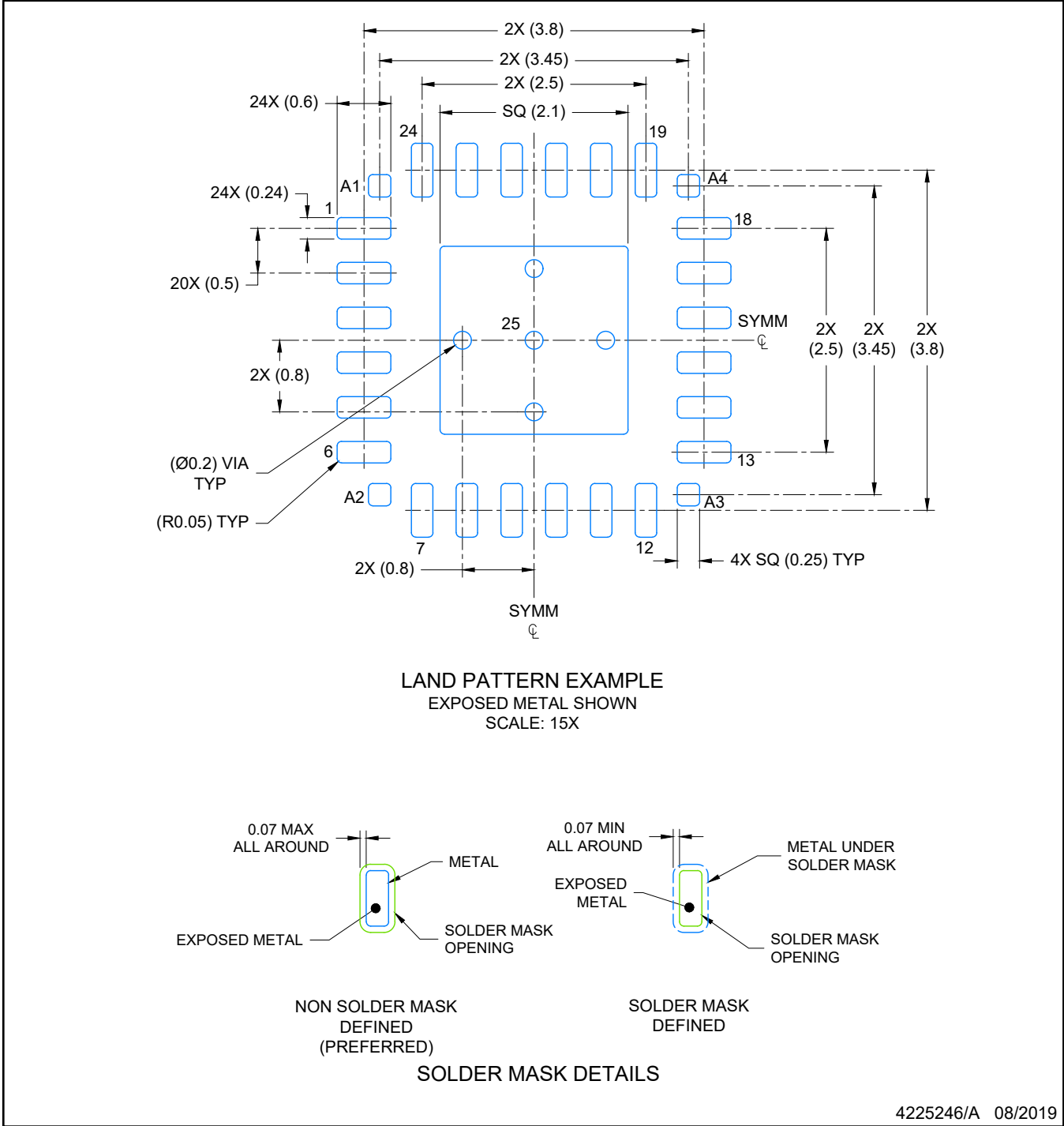

NOTES: (continued)

4. This package is designed to be soldered to a thermal pad on the board. For more information, see Texas Instruments literature number SLUA271 (www.ti.com/lit/slua271).
5. Vias are optional depending on application, refer to device data sheet. If any vias are implemented, refer to their locations shown on this view. It is recommended that vias under paste be filled, plugged or tented.

EXAMPLE STENCIL DESIGN

RGE0024R

VQFN - 1 mm max height

PLASTIC QUAD FLATPACK-NO LEAD

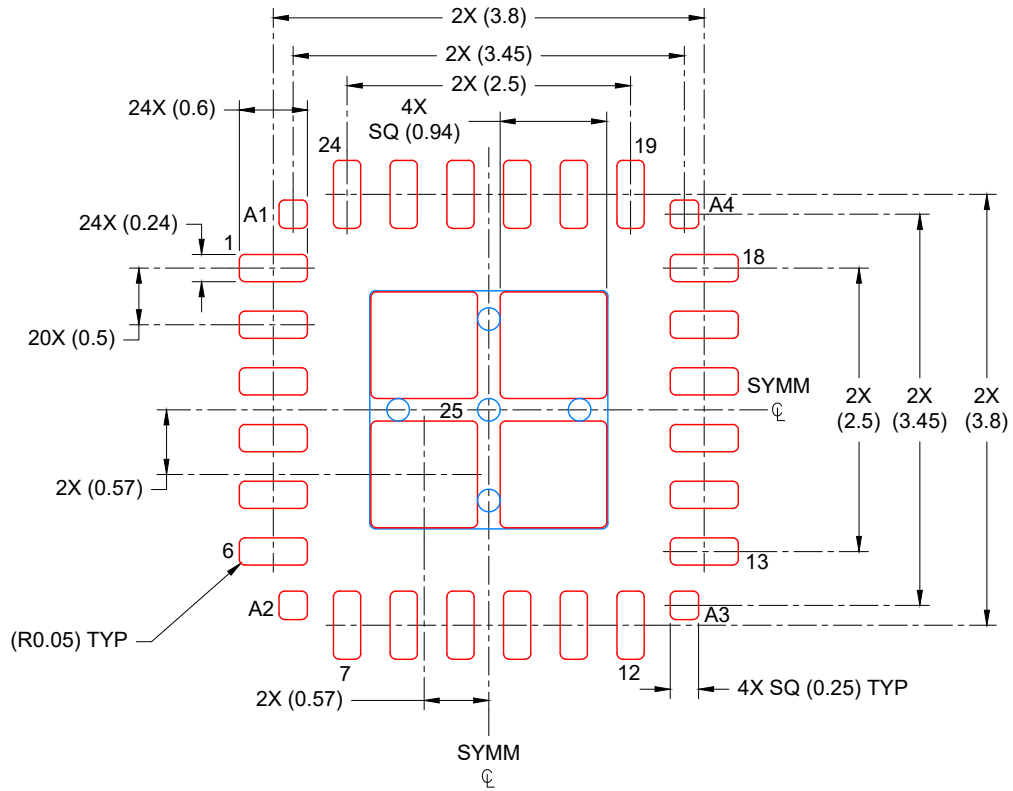

SOLDER PASTE EXAMPLE
BASED ON 0.125 mm THICK STENCIL

EXPOSED PAD
80% PRINTED COVERAGE BY AREA
SCALE: 15X

4225246/A 08/2019

NOTES: (continued)

6. Laser cutting apertures with trapezoidal walls and rounded corners may offer better paste release. IPC-7525 may have alternate design recommendations.

重要なお知らせと免責事項

テキサス・インスツルメンツは、技術データと信頼性データ(データシートを含みます)、設計リソース(リファレンス デザインを含みます)、アプリケーションや設計に関する各種アドバイス、Web ツール、安全性情報、その他のリソースを、欠陥が存在する可能性のある「現状のまま」提供しており、商品性および特定目的に対する適合性の黙示保証、第三者の知的財産権の非侵害保証を含むいかなる保証も、明示的または黙示的にかかわらず拒否します。

これらのリソースは、テキサス・インスツルメンツ製品を使用する設計の経験を積んだ開発者への提供を意図したものです。(1) お客様のアプリケーションに適したテキサス・インスツルメンツ製品の選定、(2) お客様のアプリケーションの設計、検証、試験、(3) お客様のアプリケーションに該当する各種規格や、その他のあらゆる安全性、セキュリティ、規制、または他の要件への確実な適合に関する責任を、お客様のみが単独で負うものとします。

上記の各種リソースは、予告なく変更される可能性があります。これらのリソースは、リソースで説明されているテキサス・インスツルメンツ製品を使用するアプリケーションの開発の目的でのみ、テキサス・インスツルメンツはその使用をお客様に許諾します。これらのリソースに関して、他の目的で複製することや掲載することは禁止されています。テキサス・インスツルメンツや第三者の知的財産権のライセンスが付与されている訳ではありません。お客様は、これらのリソースを自身で使用した結果発生するあらゆる申し立て、損害、費用、損失、責任について、テキサス・インスツルメンツおよびその代理人を完全に補償するものとし、テキサス・インスツルメンツは一切の責任を拒否します。

テキサス・インスツルメンツの製品は、[テキサス・インスツルメンツの販売条件](#)、または [ti.com](https://www.ti.com) やかかるテキサス・インスツルメンツ製品の関連資料などのいずれかを通じて提供する適用可能な条項の下で提供されています。テキサス・インスツルメンツがこれらのリソースを提供することは、適用されるテキサス・インスツルメンツの保証または他の保証の放棄の拡大や変更を意味するものではありません。

お客様がいかなる追加条項または代替条項を提案した場合でも、テキサス・インスツルメンツはそれらに異議を唱え、拒否します。

郵送先住所：Texas Instruments, Post Office Box 655303, Dallas, Texas 75265
Copyright © 2025, Texas Instruments Incorporated