

# OPA695 ディセーブル機能搭載、超広帯域、電流帰還オペアンプ

## 1 特長

- 広い帯域幅:
  - 1900MHz ( $G = +1V/V$ )
  - 600MHz ( $G = +8V/V$ )
- 大信号帯域幅 ( $2V_{PP}$ ): 540 MHz
- 出力電圧スイング:  $\pm 4.05 V$
- 非常に高いスルーレート: 5000V/ $\mu s$
- 入力電圧ノイズ: 2nV/ $\sqrt{Hz}$
- 低歪み ( $R_L = 100\Omega$ ,  $V_O = 2V_{PP}$ ):
  - 10MHz での HD2, HD3:  $-65dBc$ ,  $-92dBc$
- 大出力電流:  $\pm 140mA$
- 電源電圧範囲: 5V~12V
- 消費電流: 14mA
- シャットダウン電流: 160 $\mu A$

## 2 アプリケーション

- 超広帯域 ADC ドライバ
- 低コストの高精度 IF アンプ
- ブロードバンド ビデオ ラインドライバ
- 携帯型計測機器
- アクティブ フィルタ
- 任意波形の生成器
- 電流 DAC ドライバ

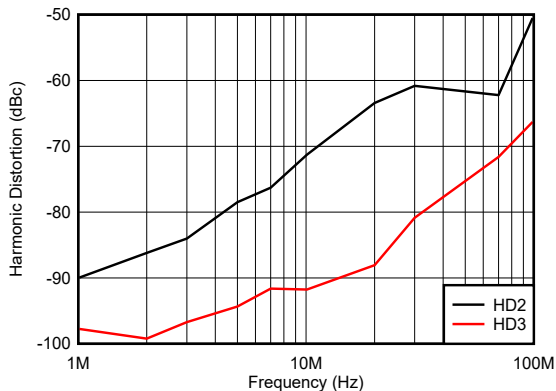

周波数に対する +8V/V ゲインでの高調波歪み

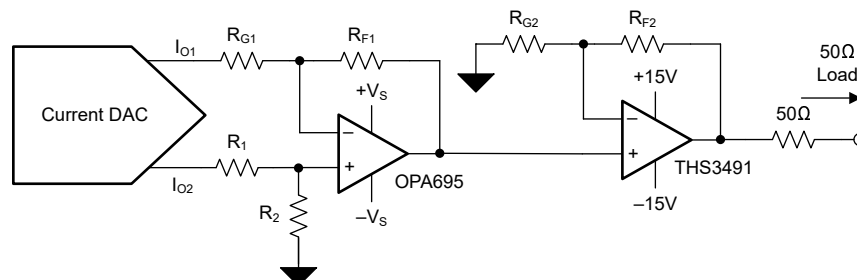

標準的な任意波形発生器の出力駆動回路

## 3 概要

OPA695 は、広い帯域幅の電流帰還オペアンプであり、5000V/ $\mu s$  の非常に優れたスルーレートと、低い入力電圧ノイズとの組み合わせにより、高速計測システムの間ゲイン段として使用される、高精度かつ低歪でダイナミックレンジの広いアンプを実現します。OPA695 は、高いゲインでの動作に最適化されており、電流 DAC 出力のインターフェイス、または高速デジタイザのゲイン段として、あるいはケーブル モデム上流ラインドライバにおいて低歪で大出力電力を供給するのに最適です。

OPA695 は、14mA (25°C) という低い消費電流を特長としています。オプションのディセーブル制御ピンを使用すると、システム消費電力をさらに低減できます。このピンをオープンのままにするか、またはこのピンを High に保持すると、通常動作になります。このピンを Low にすると、OPA695 の消費電流は 160 $\mu A$  未満に低下します。この省電力機能と、非常に優れた 5V 単一電源動作、超小型 SOT23-6 パッケージを備えた OPA695 は、ポータブルアプリケーションに最適です。

OPA695 は、 $-40^{\circ}C \sim +85^{\circ}C$  の広い温度範囲で動作します。

### パッケージ情報

部品番号	パッケージ (1)	パッケージ サイズ(2)
OPA695	D (SOIC, 8)	4.9mm × 6mm
	DBV (SOT-23, 6)	2.9mm × 2.8mm
	DGK (VSSOP, 8)	3mm × 4.9mm

- (1) 詳細については、[セクション 10](#) を参照してください。
- (2) パッケージ サイズ (長さ × 幅) は公称値であり、該当する場合はピンも含まれます。



## Table of Contents

<b>1 特長</b> .....	<b>1</b>	<b>6 Detailed Description</b> .....	<b>27</b>
<b>2 アプリケーション</b> .....	<b>1</b>	6.1 Overview.....	27
<b>3 概要</b> .....	<b>1</b>	6.2 Functional Block Diagram.....	27
<b>4 Pin Configuration and Functions</b> .....	<b>3</b>	6.3 Feature Description.....	27
<b>5 Specifications</b> .....	<b>4</b>	6.4 Device Functional Modes.....	29
5.1 Absolute Maximum Ratings.....	4	<b>7 Application and Implementation</b> .....	<b>30</b>
5.2 ESD Ratings.....	4	7.1 Application Information.....	30
5.3 Recommended Operating Conditions.....	4	7.2 Typical Application.....	39
5.4 Thermal Information.....	4	7.3 Power Supply Recommendations.....	41
5.5 Electrical Characteristics $V_S = \pm 5$ V, OPA695ID, OPA695IDBV.....	5	7.4 Layout.....	41
5.6 Electrical Characteristics $V_S = 5$ V, OPA695ID, OPA695IDBV.....	7	<b>8 Device and Documentation Support</b> .....	<b>43</b>
5.7 Electrical Characteristics $V_S = \pm 5$ V, OPA695IDGK....	9	8.1 Device Support.....	43
5.8 Electrical Characteristics $V_S = 5$ V, OPA695IDGK....	11	8.2 Documentation Support.....	43
5.9 Typical Characteristics: $V_S = \pm 5$ V, OPA695IDBV, OPA695ID.....	13	8.3 ドキュメントの更新通知を受け取る方法.....	43
5.10 Typical Characteristics: $V_S = 5$ V, OPA695IDBV, OPA695ID.....	18	8.4 サポート・リソース.....	43
5.11 Typical Characteristics: $V_S = \pm 5$ V, OPA695IDGK....	20	8.5 Trademarks.....	43
5.12 Typical Characteristics: $V_S = 5$ V, OPA695IDGK....	25	8.6 静電気放電に関する注意事項.....	43
		8.7 用語集.....	44
		<b>9 Revision History</b> .....	<b>44</b>
		<b>10 Mechanical, Packaging, and Orderable Information</b> .....	<b>48</b>

## 4 Pin Configuration and Functions

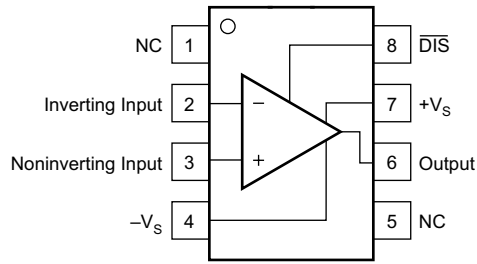

NC = No Connection

図 4-1. D Package, 8-Pin SOIC, and DGK Package, 8-Pin VSSOP (Top View)

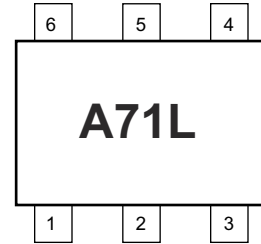
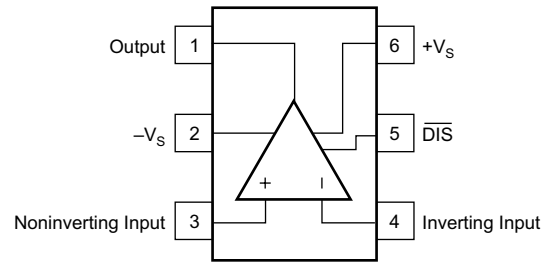

Pin Orientation/Package Marking

図 4-2. DBV Package, 6-Pin SOT-23 (Top View)

表 4-1. Pin Functions

NAME	PIN NO.		TYPE <sup>(1)</sup>	DESCRIPTION
	D (SOIC), DGK (VSSOP)	DBV (SOT-23)		
DIS	8	5	I	Not disable (enable)
Inverting input	2	4	I	Inverting input
NC	1, 5	—	—	Not connected
Noninverting input	3	3	I	Noninverting input
Output	6	1	O	Output
-Vs	4	2	P	Negative supply
+Vs	7	6	P	Positive supply

(1) I = input, O = output, P = power

## 5 Specifications

### 5.1 Absolute Maximum Ratings

over operating free-air temperature range (unless otherwise noted)<sup>(1)</sup>

		MIN	MAX	UNIT
$V_S$	Total supply voltage, $V_S = (V_{S+}) - (V_{S-})$		13	V
$V_{ID}$	Differential input voltage		$\pm 1.2$	V
$V_I$	Input common-mode voltage		$\pm V_S$	V
	Internal power dissipation	See <a href="#">Thermal Analysis</a>		
$I_{IN}$	Continuous input current		$\pm 10$	mA
$T_J$	Junction temperature		150	°C
$T_{stg}$	Storage temperature	-65	125	°C

- (1) Operation outside the *Absolute Maximum Ratings* may cause permanent device damage. *Absolute Maximum Ratings* do not imply functional operation of the device at these or any other conditions beyond those listed under *Recommended Operating Conditions*. If used outside the *Recommended Operating Conditions* but within the *Absolute Maximum Ratings*, the device may not be fully functional, and this may affect device reliability, functionality, performance, and shorten the device lifetime.

### 5.2 ESD Ratings

			VALUE	UNIT
$V_{(ESD)}$	Electrostatic discharge	Human body model (HBM), per ANSI/ESDA/JEDEC JS-001, all pins except Inverting Input <sup>(1)</sup>	$\pm 1500$	V
		Human body model (HBM), per ANSI/ESDA/JEDEC JS-001, Inverting Input <sup>(1)</sup>	$\pm 500$	
		Charged device model (CDM), per JEDEC specification JESD22-C101, all pins <sup>(2)</sup>	$\pm 1000$	

- (1) JEDEC document JEP155 states that 500-V HBM allows safe manufacturing with a standard ESD control process.

- (2) JEDEC document JEP157 states that 250-V CDM allows safe manufacturing with a standard ESD control process.

### 5.3 Recommended Operating Conditions

over operating free-air temperature range (unless otherwise noted)

		MIN	NOM	MAX	UNIT
$V_{S+} - V_{S-}$	Total supply voltage	5		12	V
$T_A$	Ambient operating air temperature	-40	25	85	°C

### 5.4 Thermal Information

THERMAL METRIC <sup>(1)</sup>		OPA695			UNIT
		D (SOIC)	DBV (SOT 23)	DGK (VSSOP)	
		8 PINS	6 PINS	6 PINS	
$R_{\theta JA}$	Junction-to-ambient thermal resistance	136	164	135	°C/W
$R_{\theta JC(top)}$	Junction-to-case (top) thermal resistance	78	80	81	°C/W
$R_{\theta JB}$	Junction-to-board thermal resistance	85	49	56	°C/W
$\Psi_{JT}$	Junction-to-top characterization parameter	24	28	8.5	°C/W
$\Upsilon_{JB}$	Junction-to-board characterization parameter	84	49	48	°C/W
$R_{\theta JC(bot)}$	Junction-to-case (bottom) thermal resistance	N/A	N/A	N/A	N/A

- (1) For more information about traditional and new thermal metrics, see the [Semiconductor and IC Package Thermal Metrics](#) application report.

## 5.5 Electrical Characteristics $V_S = \pm 5\text{ V}$ , OPA695ID, OPA695IDBV

at  $T_A = +25^\circ\text{C}$ ,  $G = +8\text{ V/V}$ ,  $R_F = 402\ \Omega$ , and  $R_L = 100\ \Omega$  to  $V_S/2$  (unless otherwise noted)

PARAMETER		TEST CONDITIONS		MIN	TYP	MAX	UNIT
<b>AC PERFORMANCE</b>							
SSBW	Small-signal bandwidth	$V_O = 0.5\text{ V}_{PP}$	$G = +1\text{ V/V}$ , $R_F = 523\ \Omega$	1900		MHz	
			$G = +2\text{ V/V}$ , $R_F = 511\ \Omega$	900			
			$G = +8\text{ V/V}$ , $R_F = 402\ \Omega$	600			
			$G = +16\text{ V/V}$ , $R_F = 249\ \Omega$	500			
	Bandwidth for 0.2-dB gain flatness	$V_O = 0.5\text{ V}_{PP}$ , $G = +2\text{ V/V}$ , $R_F = 511\ \Omega$	120			MHz	
	Peaking at a gain of +1V/V	$V_O = 0.5\text{ V}_{PP}$ , $R_F = 523\ \Omega$	3.7			dB	
LSBW	Large-signal bandwidth	$V_O = 4\text{ V}_{PP}$ , $G = +8\text{ V/V}$	510			MHz	
SR	Slew rate	$V_O = 4\text{-V step}$	$G = -8\text{ V/V}$	5000			V/ $\mu\text{s}$
			$G = +8\text{ V/V}$	5000			V/ $\mu\text{s}$
	Rise and fall time	$G = +8\text{ V/V}$	$V_O = 0.5\text{-V step}$	0.65		ns	
			$V_O = 4\text{-V step}$	0.7			
	Settling time	To 0.5%, $V_O = 2\text{-V step}$ , $G = +8\text{ V/V}$	10			ns	
HD2	2nd-order harmonic distortion	$f = 10\text{ MHz}$	$V_O = 2\text{ V}_{PP}$ , $R_L = 100\ \Omega$	-75		dBc	
			$V_O = 2\text{ V}_{PP}$ , $R_L = 500\ \Omega$	-78			
HD3	3rd-order harmonic distortion	$f = 10\text{ MHz}$	$V_O = 2\text{ V}_{PP}$ , $R_L = 100\ \Omega$	-92		dBc	
			$V_O = 2\text{ V}_{PP}$ , $R_L = 500\ \Omega$	-86			
$e_n$	Input voltage noise	$f > 1\text{ MHz}$	2			nV/ $\sqrt{\text{Hz}}$	
$i_{n+}$	Noninverting input current noise	$f > 1\text{ MHz}$	14			pA/ $\sqrt{\text{Hz}}$	
$i_{n-}$	Inverting input current noise	$f > 1\text{ MHz}$	22			pA/ $\sqrt{\text{Hz}}$	
<b>DC PERFORMANCE</b>							
$Z_{OL}$	Open-loop transimpedance gain			45	300	k $\Omega$	
		$T_A = -40^\circ\text{C to } +85^\circ\text{C}$		41			
$V_{OS}$	Input offset voltage	$V_{CM} = 0\text{ V}$			$\pm 0.3$	$\pm 3$	mV
			$T_A = -40^\circ\text{C to } +85^\circ\text{C}$		$\pm 4$		
	Average input offset voltage drift	$V_{CM} = 0\text{ V}$ , $T_A = -40^\circ\text{C to } +85^\circ\text{C}$		3	$\pm 15$	$\mu\text{V}/^\circ\text{C}$	
	Noninverting input bias current	$V_{CM} = 0\text{ V}$			13	$\pm 30$	$\mu\text{A}$
			$T_A = -40^\circ\text{C to } +85^\circ\text{C}$		$\pm 41$		
	Average noninverting input bias current drift	$V_{CM} = 0\text{ V}$ , $T_A = -40^\circ\text{C to } +85^\circ\text{C}$		60	180	nA/ $^\circ\text{C}$	
	Inverting input bias current	$V_{CM} = 0\text{ V}$			$\pm 5$	$\pm 60$	$\mu\text{A}$
			$T_A = -40^\circ\text{C to } +85^\circ\text{C}$		$\pm 70$		
	Average inverting input bias current drift	$V_{CM} = 0\text{ V}$ , $T_A = -40^\circ\text{C to } +85^\circ\text{C}$		$\pm 16$	$\pm 160$	nA/ $^\circ\text{C}$	
<b>INPUT CHARACTERISTICS</b>							
CMIR	Common-mode input range <sup>(1)</sup>			$\pm 3.1$	$\pm 3.4$	V	
		$T_A = -40^\circ\text{C to } +85^\circ\text{C}$		$\pm 3.0$			
CMRR	Common-mode rejection ratio	$V_{CM} = 0\text{ V}$			51	65	dB
			$T_A = -40^\circ\text{C to } +85^\circ\text{C}$		50		
	Noninverting input impedance	Open-loop		450    2		k $\Omega$    pF	
	Inverting input resistance	Open-loop		20		$\Omega$	

## 5.5 Electrical Characteristics $V_S = \pm 5\text{ V}$ , OPA695ID, OPA695IDBV (続き)

at  $T_A = +25^\circ\text{C}$ ,  $G = +8\text{ V/V}$ ,  $R_F = 402\ \Omega$ , and  $R_L = 100\ \Omega$  to  $V_S/2$  (unless otherwise noted)

PARAMETER		TEST CONDITIONS		MIN	TYP	MAX	UNIT
<b>OUTPUT CHARACTERISTICS</b>							
	Output voltage swing	No load		$\pm 3.95$	$\pm 4.05$		V
			$T_A = -40^\circ\text{C}$ to $+85^\circ\text{C}$	$\pm 3.85$			
		$R_L = 100\ \Omega$		$\pm 3.65$	$\pm 3.75$		
			$T_A = -40^\circ\text{C}$ to $+85^\circ\text{C}$	$\pm 3.55$			
$I_O$	Output current, sourcing	$V_O = 0\text{ V}$		90	140		mA
			$T_A = -40^\circ\text{C}$ to $+85^\circ\text{C}$	70			
	Output current, sinking	$V_O = 0\text{ V}$			-140	-90	mA
			$T_A = -40^\circ\text{C}$ to $+85^\circ\text{C}$			-70	
$Z_O$	Closed-loop output impedance	$G = +8\text{ V/V}$ , $f = 100\text{ kHz}$			0.02		$\Omega$
<b>POWER SUPPLY</b>							
$I_Q$	Quiescent current			11.7	14	15.6	mA
		$T_A = -40^\circ\text{C}$ to $+85^\circ\text{C}$		10		18	
-PSRR	Negative power-supply rejection ratio			51	72		dB
		$T_A = -40^\circ\text{C}$ to $+85^\circ\text{C}$		48			
<b>DISABLE (Disabled LOW)</b>							
	Power-down quiescent current	$V_{DIS} = 0\text{ V}$			160	200	$\mu\text{A}$
			$T_A = -40^\circ\text{C}$ to $+85^\circ\text{C}$			210	
	Disable time	$V_{IN} = \pm 0.25\text{ V}_{DC}$			4		$\mu\text{s}$
	Enable time	$V_{IN} = \pm 0.25\text{ V}_{DC}$			80		ns
	Off Isolation	$G = +8\text{ V/V}$ , $f = 10\text{ MHz}$			70		dB
	Output capacitance in disable				2.5		pF
	Enable voltage threshold				3	3.5	V
		$T_A = -40^\circ\text{C}$ to $+85^\circ\text{C}$				3.7	
	Disable voltage threshold			1.7	2.3		V
		$T_A = -40^\circ\text{C}$ to $+85^\circ\text{C}$		1.5			
	DIS control pin input bias current	$V_{DIS} = 0\text{ V}$			95	130	$\mu\text{A}$
			$T_A = -40^\circ\text{C}$ to $+85^\circ\text{C}$			145	

(1) Tested  $< 3\text{ dB}$  below minimum specified CMRR at  $\pm$  CMIR limits.

## 5.6 Electrical Characteristics $V_S = 5\text{ V}$ , OPA695ID, OPA695IDBV

at  $T_A = +25^\circ\text{C}$ ,  $G = +8\text{ V/V}$ ,  $R_F = 348\ \Omega$ , and  $R_L = 100\ \Omega$  to  $V_S/2$  (unless otherwise noted)

PARAMETER		TEST CONDITIONS		MIN	TYP	MAX	UNIT
<b>AC PERFORMANCE</b>							
SSBW	Small-signal bandwidth	$V_O = 0.5\ V_{PP}$	$G = +1\text{ V/V}$ , $R_F = 511\ \Omega$		1200		MHz
			$G = +2\text{ V/V}$ , $R_F = 487\ \Omega$		700		
			$G = +8\text{ V/V}$ , $R_F = 348\ \Omega$		500		
			$G = +16\text{ V/V}$ , $R_F = 162\ \Omega$		410		
	Bandwidth for 0.2-dB gain flatness	$V_O = 0.5\ V_{PP}$ , $G = +2\text{ V/V}$ , $R_F = 487\ \Omega$			110		MHz
	Peaking at a gain of +1 V/V	$V_O = 0.5\ V_{PP}$ , $R_F = 511\ \Omega$			2.2		dB
LSBW	Large-signal bandwidth	$V_O = 2\ V_{PP}$ , $G = +8\text{ V/V}$			430		MHz
SR	Slew rate	$V_O = 2\text{-V step}$ , $G = +8\text{ V/V}$			2500		V/ $\mu\text{s}$
	Rise and fall time	$G = +8\text{ V/V}$	$V_O = 0.5\text{-V step}$		0.7		ns
			$V_O = 2\text{-V step}$		0.8		
	Settling time to 0.5%	$V_O = 2\text{-V step}$ , $G = +8\text{ V/V}$			10		ns
HD2	2nd-order harmonic distortion	$f = 10\text{ MHz}$	$V_O = 2\ V_{PP}$ , $R_L = 100\ \Omega$		-69		dBc
			$V_O = 2\ V_{PP}$ , $R_L = 500\ \Omega$		-68		
HD3	3rd-order harmonic distortion	$f = 10\text{ MHz}$	$V_O = 2\ V_{PP}$ , $R_L = 100\ \Omega$		-62		dBc
			$V_O = 2\ V_{PP}$ , $R_L = 500\ \Omega$		-63		
$e_n$	Input voltage noise	$f > 1\text{ MHz}$			1.9		nV/ $\sqrt{\text{Hz}}$
$i_{n+}$	Noninverting input current noise	$f > 1\text{ MHz}$			14		pA/ $\sqrt{\text{Hz}}$
$i_{n-}$	Inverting input current noise	$f > 1\text{ MHz}$			22		pA/ $\sqrt{\text{Hz}}$
<b>DC PERFORMANCE</b>							
$Z_{OL}$	Open-loop transimpedance gain	$T_A = -40^\circ\text{C to } +85^\circ\text{C}$		40	250		k $\Omega$
				36			
$V_{OS}$	Input offset voltage	$V_{CM} = V_S/2$			$\pm 0.3$	$\pm 3$	mV
			$T_A = -40^\circ\text{C to } +85^\circ\text{C}$			$\pm 4$	
	Average input offset voltage drift	$V_{CM} = V_S/2$ , $T_A = -40^\circ\text{C to } +85^\circ\text{C}$			$\pm 4$	$\pm 15$	$\mu\text{V}/^\circ\text{C}$
	Noninverting input bias current	$V_{CM} = V_S/2$			15	$\pm 40$	$\mu\text{A}$
			$T_A = -40^\circ\text{C to } +85^\circ\text{C}$			$\pm 50$	
	Average noninverting input bias current drift	$V_{CM} = V_S/2$ , $T_A = -40^\circ\text{C to } +85^\circ\text{C}$			60	$\pm 170$	nA/ $^\circ\text{C}$
	Inverting input bias current	$V_{CM} = V_S/2$			$\pm 5$	$\pm 60$	$\mu\text{A}$
			$T_A = -40^\circ\text{C to } +85^\circ\text{C}$			$\pm 70$	
	Average inverting input bias current drift	$V_{CM} = V_S/2$ , $T_A = -40^\circ\text{C to } +85^\circ\text{C}$			$\pm 16$	$\pm 160$	nA/ $^\circ\text{C}$
<b>INPUT CHARACTERISTICS</b>							
CMIR	Common-mode input range (positive)	$T_A = -40^\circ\text{C to } +85^\circ\text{C}$		3.2	3.4		V
				3.1			
	Common-mode input range (negative)	$T_A = -40^\circ\text{C to } +85^\circ\text{C}$			1.6	1.8	
						1.9	
CMRR	Common-mode rejection ratio	$V_{CM} = V_S/2$		51	65		dB
			$T_A = -40^\circ\text{C to } +85^\circ\text{C}$		50		
	Noninverting input resistance				250    2		k $\Omega$    pF
	Inverting input resistance	Open-loop			21		$\Omega$

## 5.6 Electrical Characteristics $V_S = 5\text{ V}$ , OPA695ID, OPA695IDBV (続き)

at  $T_A = +25^\circ\text{C}$ ,  $G = +8\text{ V/V}$ ,  $R_F = 348\ \Omega$ , and  $R_L = 100\ \Omega$  to  $V_S/2$  (unless otherwise noted)

PARAMETER		TEST CONDITIONS		MIN	TYP	MAX	UNIT
<b>OUTPUT CHARACTERISTICS</b>							
$V_O$	Output voltage swing (most positive)	No load		3.95	4.05		V
			$T_A = -40^\circ\text{C}$ to $85^\circ\text{C}$	3.75			
$V_O$	Output voltage swing (least positive)	No load			0.9	1.05	V
			$T_A = -40^\circ\text{C}$ to $+85^\circ\text{C}$			1.25	
$I_O$	Output current, sourcing	$V_O = V_S/2$		70	100		mA
			$T_A = -40^\circ\text{C}$ to $+85^\circ\text{C}$	66			
$I_O$	Output current, sinking	$V_O = V_S/2$			-100	-70	mA
			$T_A = -40^\circ\text{C}$ to $+85^\circ\text{C}$			-60	
$Z_{OUT}$	Closed-loop output impedance	$G = +2\text{ V/V}$ , $f = 100\text{ kHz}$			0.02		$\Omega$
<b>POWER SUPPLY</b>							
$I_Q$	Quiescent current			10.9	13	14.4	mA
		$T_A = -40^\circ\text{C}$ to $+85^\circ\text{C}$		9.1		17.1	
-PSRR	Negative power-supply rejection ratio				69		dB
<b>DISABLE (Disabled LOW)</b>							
	Power-down quiescent current ( $+V_S$ )	$V_{DIS} = 0\text{ V}$			120	160	$\mu\text{A}$
			$T_A = -40^\circ\text{C}$ to $+85^\circ\text{C}$			180	
	Disable time	$V_{IN} = \pm 0.25\text{ V}_{DC}$			5		$\mu\text{s}$
	Enable time	$V_{IN} = \pm 0.25\text{ V}_{DC}$			80		ns
	Off isolation	$G = +8\text{ V/V}$ , $f = 10\text{ MHz}$			70		dB
	Output capacitance in disable				2.5		pF
	Enable voltage threshold				3.1	3.5	V
		$T_A = -40^\circ\text{C}$ to $+85^\circ\text{C}$				3.7	
	Disable voltage threshold			1.7	2.4		V
		$T_A = -40^\circ\text{C}$ to $+85^\circ\text{C}$		1.5			
	DIS control pin input bias current				95	130	$\mu\text{A}$
		$T_A = -40^\circ\text{C}$ to $+85^\circ\text{C}$				149	



## 5.7 Electrical Characteristics $V_S = \pm 5\text{ V}$ , OPA695IDGK

at  $T_A = +25^\circ\text{C}$ ,  $G = +8\text{ V/V}$ ,  $V_S = \pm 5\text{ V}$ ,  $R_F = 402\ \Omega$ , and  $R_L = 100\ \Omega$  to  $V_S/2$  (unless otherwise noted)

PARAMETER		TEST CONDITIONS		MIN	TYP	MAX	UNIT
<b>AC PERFORMANCE</b>							
SSBW	Small-signal bandwidth	$V_O = 0.5\ V_{PP}$	$G = +1\text{ V/V}$ , $R_F = 523\ \Omega$		1700		MHz
			$G = +2\text{ V/V}$ , $R_F = 511\ \Omega$		1400		
			$G = +8\text{ V/V}$ , $R_F = 402\ \Omega$		450		
			$G = +16\text{ V/V}$ , $R_F = 249\ \Omega$		350		
	Bandwidth for 0.2-dB gain flatness	$G = +2\text{ V/V}$ , $V_O = 0.5\ V_{PP}$ , $R_F = 511\ \Omega$			320		MHz
	Peaking at a gain of +1V/V	$R_F = 523\ \Omega$ , $V_O = 0.5\ V_{PP}$			4.6		dB
LSBW	Large-signal bandwidth	$G = +8\text{ V/V}$ , $V_O = 4\ V_{PP}$			450		MHz
SR	Slew rate	$V_O = 4\text{-V step}$	$G = -8\text{ V/V}$		4300		V/ $\mu\text{s}$
			$G = +8\text{ V/V}$		2900		
	Rise and fall time	$G = +8\text{ V/V}$	$V_O = 0.5\text{-V step}$		0.8		ns
			$V_O = 4\text{-V step}$		1		
	Settling time	$V_O = 2\text{-V step}$ , 0.02%			16		ns
			$V_O = 2\text{-V step}$ , 0.1%		10		
HD2	2nd-order harmonic distortion	$f = 10\text{ MHz}$	$V_O = 2\ V_{PP}$ , $R_L = 100\ \Omega$		-65		dBc
			$V_O = 2\ V_{PP}$ , $R_L = 500\ \Omega$		-78		
HD3	3rd-order harmonic distortion	$f = 10\text{ MHz}$	$V_O = 2\ V_{PP}$ , $R_L = 100\ \Omega$		-86		dBc
			$V_O = 2\ V_{PP}$ , $R_L = 500\ \Omega$		-86		
$e_n$	Input voltage noise	$f > 1\text{ MHz}$			1.8		nV/ $\sqrt{\text{Hz}}$
$i_{n+}$	Noninverting input current noise	$f > 1\text{ MHz}$			18		pA/ $\sqrt{\text{Hz}}$
$i_{n-}$	Inverting input current noise	$f > 1\text{ MHz}$			22		pA/ $\sqrt{\text{Hz}}$
<b>DC PERFORMANCE</b>							
$Z_{OL}$	Open-loop transimpedance gain	$V_O = 0\text{ V}$			45	85	k $\Omega$
			$T_A = -40^\circ\text{C}$ to $+85^\circ\text{C}$		41		
$V_{OS}$	Input offset voltage	$V_{CM} = 0\text{ V}$			$\pm 0.3$	$\pm 3$	mV
			$T_A = -40^\circ\text{C}$ to $+85^\circ\text{C}$			$\pm 4$	
	Average input offset voltage drift	$V_{CM} = 0\text{ V}$ , $T_A = -40^\circ\text{C}$ to $+85^\circ\text{C}$				$\pm 15$	$\mu\text{V}/^\circ\text{C}$
	Noninverting input bias current	$V_{CM} = 0\text{ V}$			13	$\pm 30$	$\mu\text{A}$
			$T_A = T_A = -40^\circ\text{C}$ to $+85^\circ\text{C}$			$\pm 41$	
	Average noninverting input bias current drift	$V_{CM} = 0\text{ V}$ , $T_A = T_A = -40^\circ\text{C}$ to $+85^\circ\text{C}$				+150	nA/ $^\circ\text{C}$
	Inverting input bias current	$V_{CM} = 0\text{ V}$			$\pm 20$	$\pm 60$	$\mu\text{A}$
			$T_A = T_A = -40^\circ\text{C}$ to $+85^\circ\text{C}$			$\pm 70$	
	Average inverting input bias current drift	$V_{CM} = 0\text{ V}$ , $T_A = T_A = -40^\circ\text{C}$ to $+85^\circ\text{C}$				$\pm 160$	nA/ $^\circ\text{C}$
<b>INPUT CHARACTERISTICS</b>							
CMIR	Common-mode input range <sup>(1)</sup>				$\pm 3.1$	$\pm 3.3$	V
			$T_A = -40^\circ\text{C}$ to $+85^\circ\text{C}$		$\pm 3$		
CMRR	Common-mode rejection ratio	$V_{CM} = 0\text{ V}$			51	56	dB
			$T_A = -40^\circ\text{C}$ to $+85^\circ\text{C}$		50		
	Noninverting input impedance				280    1.2		k $\Omega$    pF
$R_i$	Inverting input resistance	Open-loop			29		$\Omega$

## 5.7 Electrical Characteristics $V_S = \pm 5\text{ V}$ , OPA695IDGK (続き)

at  $T_A = +25^\circ\text{C}$ ,  $G = +8\text{ V/V}$ ,  $V_S = \pm 5\text{ V}$ ,  $R_F = 402\ \Omega$ , and  $R_L = 100\ \Omega$  to  $V_S/2$  (unless otherwise noted)

PARAMETER		TEST CONDITIONS		MIN	TYP	MAX	UNIT
<b>OUTPUT CHARACTERISTICS</b>							
$V_O$	Output voltage swing	No load		$\pm 4$	$\pm 4.2$		V
			$T_A = -40^\circ\text{C}$ to $+85^\circ\text{C}$	$\pm 3.9$			
		$R_L = 100\ \Omega$		$\pm 3.7$	$\pm 3.9$		V
			$T_A = -40^\circ\text{C}$ to $+85^\circ\text{C}$	$\pm 3.6$			
$I_O$	Output current, sourcing	$V_O = 0\text{ V}$		90	120		mA
			$T_A = -40^\circ\text{C}$ to $+85^\circ\text{C}$	70			
	Output current, sinking	$V_O = 0\text{ V}$			-120	-90	mA
			$T_A = -40^\circ\text{C}$ to $+85^\circ\text{C}$			-70	
$Z_{OUT}$	Closed-loop output impedance	$G = +8\text{ V/V}$ , $f = 100\text{ kHz}$			0.04		$\Omega$
<b>POWER SUPPLY</b>							
$I_Q$	Quiescent current			12.6	12.9	13.3	mA
		$T_A = -40^\circ\text{C}$ to $+85^\circ\text{C}$		11		14.1	
-PSRR	Negative power-supply rejection ratio			51	55		dB
		$T_A = -40^\circ\text{C}$ to $+85^\circ\text{C}$		48			
<b>DISABLE (Disabled LOW)</b>							
	Power-down quiescent current ( $+V_S$ )	$V_{DIS} = 0\text{ V}$			100	170	$\mu\text{A}$
			$T_A = -40^\circ\text{C}$ to $+85^\circ\text{C}$			192	
	Disable time	$V_{IN} = \pm 0.25\text{ V}_{DC}$			1		$\mu\text{s}$
	Enable time	$V_{IN} = \pm 0.25\text{ V}_{DC}$			25		ns
	Off Isolation	$G = +8\text{ V/V}$ , $f = 10\text{ MHz}$			70		dB
	Output capacitance in disable				4		pF
	Turn-on glitch	$G = +2\text{ V/V}$ , $R_L = 150\ \Omega$ , $V_{IN} = 0\text{ V}$			$\pm 100$		mV
	Turn-off glitch	$G = +2\text{ V/V}$ , $R_L = 150\ \Omega$ , $V_{IN} = 0\text{ V}$			$\pm 20$		mV
	Enable voltage threshold				3.3	3.5	V
		$T_A = -40^\circ\text{C}$ to $+85^\circ\text{C}$				3.7	
	Disable voltage threshold			1.7	1.8		V
		$T_A = -40^\circ\text{C}$ to $+85^\circ\text{C}$		1.5			
	$\overline{DIS}$ control pin input bias current				75	130	$\mu\text{A}$
		$T_A = -40^\circ\text{C}$ to $+85^\circ\text{C}$				145	

(1) Tested < 3 dB below minimum specified CMRR at  $\pm$  CMIR limits.

### 5.8 Electrical Characteristics $V_S = 5\text{ V}$ , OPA695IDGK

at  $T_A = +25^\circ\text{C}$ ,  $G = +8\text{ V/V}$ ,  $V_S = 5\text{ V}$ ,  $R_F = 348\ \Omega$ , and  $R_L = 100\ \Omega$  to  $V_S/2$  (unless otherwise noted)

PARAMETER		TEST CONDITIONS		MIN	TYP	MAX	UNIT
<b>AC PERFORMANCE</b>							
SSBW	Small-signal bandwidth	$V_O = 0.5\ V_{PP}$	$G = +1\text{ V/V}$ , $R_F = 511\ \Omega$	1400		MHz	
			$G = +2\text{ V/V}$ , $R_F = 487\ \Omega$	960			
			$G = +8\text{ V/V}$ , $R_F = 348\ \Omega$	395			
			$G = +16\text{ V/V}$ , $R_F = 162\ \Omega$	235			
	Bandwidth for 0.2-dB gain flatness	$G = +2$ , $V_O = 0.5\ V_{PP}$ , $R_F = 487\ \Omega$		230		MHz	
	Peaking at a gain of +1 V/V	$R_F = 511\ \Omega$ , $V_O = 0.5\ V_{PP}$		1		2	dB
LSBW	Large-signal bandwidth	$G = +8\text{ V/V}$ , $V_O = 2\ V_{PP}$		310			MHz
SR	Slew rate	$G = +8\text{ V/V}$ , $V_O = 2\text{-V step}$		1700			V/ $\mu\text{s}$
	Rise and fall time (10% to 90%)	$G = +8\text{ V/V}$	$V_O = 0.5\text{-V step}$	1		ns	
			$V_O = 2\text{-V step}$	1			
	Settling time	To 0.02%, $V_O = 2\text{-V step}$		16		ns	
		To 0.1%, $V_O = 2\text{-V step}$		10		ns	
HD2	2nd-order harmonic distortion	$f = 10\text{ MHz}$	$V_O = 2\ V_{PP}$ , $R_L = 100\ \Omega$	-62		-58	dBc
			$V_O = 2\ V_{PP}$ , $R_L = 500\ \Omega$	-70		-66	
HD3	3rd-order harmonic distortion	$f = 10\text{ MHz}$	$V_O = 2\ V_{PP}$ , $R_L = 100\ \Omega$	-66		-64	dBc
			$V_O = 2\ V_{PP}$ , $R_L = 500\ \Omega$	-65		-63	
$e_n$	Input voltage noise	$f > 1\text{ MHz}$		1.8		2	nV/ $\sqrt{\text{Hz}}$
$i_{n+}$	Noninverting input current noise	$f > 1\text{ MHz}$		18		19	pA/ $\sqrt{\text{Hz}}$
$i_{n-}$	Inverting input current noise	$f > 1\text{ MHz}$		22		24	pA/ $\sqrt{\text{Hz}}$
<b>DC PERFORMANCE</b>							
$Z_{OL}$	Open-loop transimpedance gain	$V_O = V_S/2$		40		70	k $\Omega$
			$T_A = -40^\circ\text{C to } +85^\circ\text{C}$	36			
	Input offset voltage	$V_{CM} = V_S/2$			$\pm 0.3$	$\pm 3$	mV
			$T_A = -40^\circ\text{C to } +85^\circ\text{C}$			$\pm 4$	
	Average input offset voltage drift	$V_{CM} = V_S/2$ , $T_A = -40^\circ\text{C to } +85^\circ\text{C}$				$\pm 15$	$\mu\text{V}/^\circ\text{C}$
	Noninverting input bias current	$V_{CM} = V_S/2$			$\pm 5$	$\pm 40$	$\mu\text{A}$
			$T_A = -40^\circ\text{C to } +85^\circ\text{C}$			$\pm 50$	
	Average noninverting input bias current drift	$V_{CM} = V_S/2$ , $T_A = -40^\circ\text{C to } +85^\circ\text{C}$				$\pm 170$	nA/ $^\circ\text{C}$
	Inverting input bias current	$V_{CM} = V_S/2$			$\pm 5$	$\pm 60$	$\mu\text{A}$
			$T_A = -40^\circ\text{C to } +85^\circ\text{C}$			$\pm 70$	
	Average inverting input bias current drift	$V_{CM} = V_S/2$ , $T_A = -40^\circ\text{C to } +85^\circ\text{C}$				$\pm 160$	nA/ $^\circ\text{C}$
<b>INPUT CHARACTERISTICS</b>							
CMIR	Common-mode input range (positive) <sup>(1)</sup>			3.2		3.3	V
		$T_A = -40^\circ\text{C to } +85^\circ\text{C}$		3.1			
	Common-mode input range (negative) <sup>(1)</sup>				1.7	1.8	
		$T_A = -40^\circ\text{C to } +85^\circ\text{C}$				1.9	
CMRR	Common-mode rejection ratio	$V_{CM} = V_S/2$		51		54	dB
			$T_A = -40^\circ\text{C to } +85^\circ\text{C}$	50			
	Noninverting input resistance			280    1.2		k $\Omega$    pF	
	Inverting input resistance	Open-loop		32		$\Omega$	

## 5.8 Electrical Characteristics $V_S = 5\text{ V}$ , OPA695IDGK (続き)

at  $T_A = +25^\circ\text{C}$ ,  $G = +8\text{ V/V}$ ,  $V_S = 5\text{ V}$ ,  $R_F = 348\ \Omega$ , and  $R_L = 100\ \Omega$  to  $V_S/2$  (unless otherwise noted)

PARAMETER		TEST CONDITIONS		MIN	TYP	MAX	UNIT
<b>OUTPUT CHARACTERISTICS</b>							
$V_O$	Output voltage swing (most positive)	No load		4.0	4.2		V
			$T_A = -40^\circ\text{C}$ to $+85^\circ\text{C}$	3.8			
	$R_L = 100\ \Omega$			3.9	4		V
			$T_A = -40^\circ\text{C}$ to $+85^\circ\text{C}$	3.7			
Output voltage swing (least positive)	No load				0.8	1	V
			$T_A = -40^\circ\text{C}$ to $+85^\circ\text{C}$				
	$R_L = 100\ \Omega$				1	1.1	V
			$T_A = -40^\circ\text{C}$ to $+85^\circ\text{C}$				
$I_O$	Output current, sourcing	$V_O = V_S/2$		70	90		mA
			$T_A = -40^\circ\text{C}$ to $+85^\circ\text{C}$	66			
	Output current, sinking	$V_O = V_S/2$			-90	-70	mA
			$T_A = -40^\circ\text{C}$ to $+85^\circ\text{C}$				
$Z_{OUT}$	Closed-loop output impedance	$G = +2\text{ V/V}$ , $f = 100\text{ kHz}$			0.05		$\Omega$
<b>POWER SUPPLY</b>							
$I_Q$	Quiescent current			10.9	11.4	12	mA
		$T_A = -40^\circ\text{C}$ to $+85^\circ\text{C}$		9.1		12.9	
-PSRR	Negative power-supply rejection ratio				56		dB
<b>DISABLE (Disabled LOW)</b>							
	Power-down quiescent current	$V_{DIS} = 0\text{ V}$			95	160	$\mu\text{A}$
			$T_A = -40^\circ\text{C}$ to $+85^\circ\text{C}$				
	Disable time	$V_{IN} = \pm 0.25\text{ V}_{DC}$			1		$\mu\text{s}$
	Enable time	$V_{IN} = \pm 0.25\text{ V}_{DC}$			25		ns
	Off isolation	$G = +8\text{ V/V}$ , $f = 10\text{ MHz}$			70		dB
	Output capacitance in disable				4		pF
	Turn-on glitch	$G = +2\text{ V/V}$ , $R_L = 150\ \Omega$ , $V_{IN} = 0\text{ V}$			$\pm 100$		mV
	Turn-off glitch	$G = +2\text{ V/V}$ , $R_L = 150\ \Omega$ , $V_{IN} = 0\text{ V}$			$\pm 20$		mV
	Enable voltage				3.3	3.5	V
		$T_A = -40^\circ\text{C}$ to $+85^\circ\text{C}$					
	Disable voltage threshold			1.7	1.8		V
		$T_A = -40^\circ\text{C}$ to $+85^\circ\text{C}$		1.5			
	$\overline{DIS}$ control pin input bias current				75	130	$\mu\text{A}$
		$T_A = -40^\circ\text{C}$ to $+85^\circ\text{C}$					

(1) Tested < 3 dB below minimum specified CMRR at  $\pm$  CMIR limits.

### 5.9 Typical Characteristics: $V_S = \pm 5\text{ V}$ , OPA695IDBV, OPA695ID

at  $T_A = +25^\circ\text{C}$ ,  $G = +8\text{ V/V}$ ,  $R_F = 402\ \Omega$ , and  $R_L = 100\ \Omega$  (unless otherwise noted)

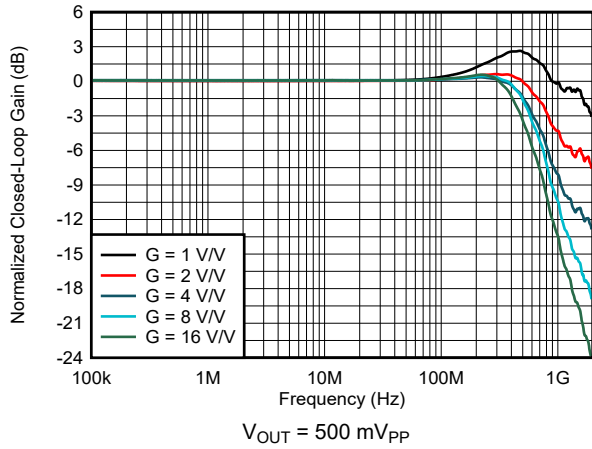

Figure 5-1. Noninverting Small-Signal Frequency Response

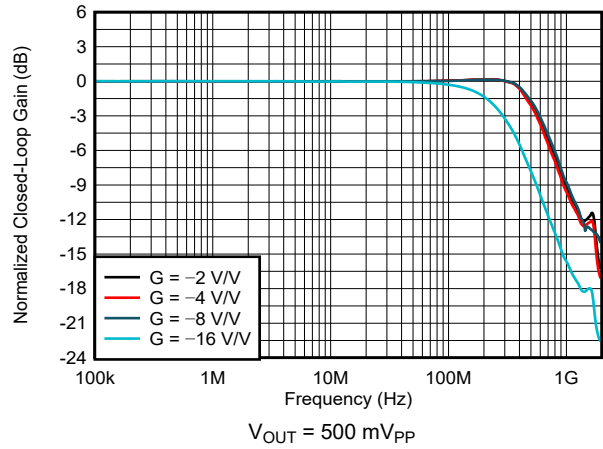

Figure 5-2. Inverting Small-Signal Frequency Response

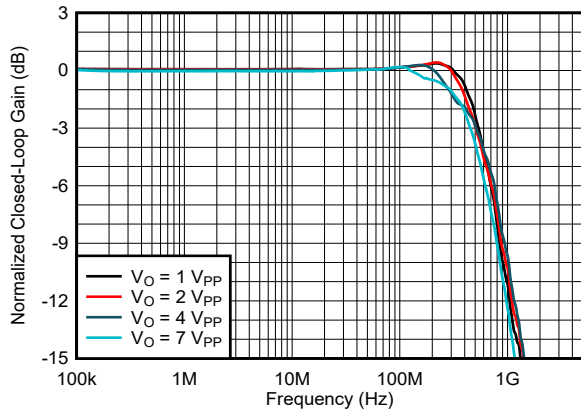

Figure 5-3. Noninverting Large-Signal Frequency Response

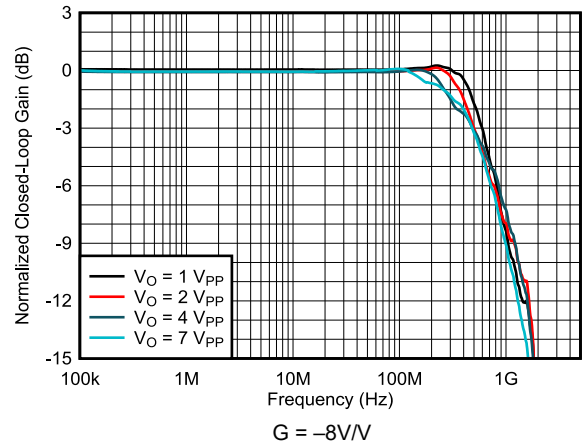

Figure 5-4. Inverting Large-Signal Frequency Response

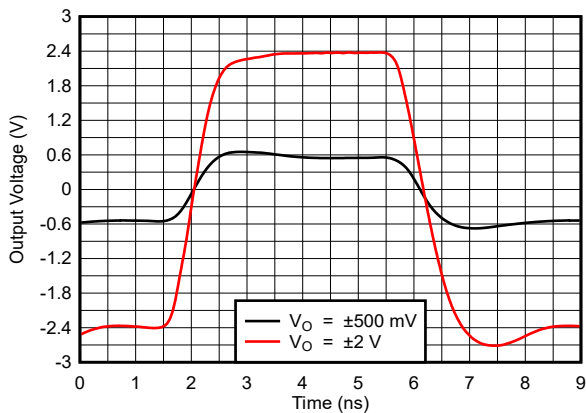

Figure 5-5. Noninverting Large and Small-Signal Frequency Response

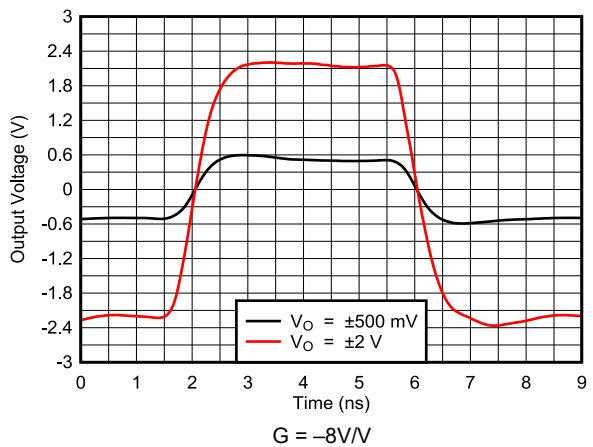

Figure 5-6. Inverting Large and Small-Signal Frequency Response

### 5.9 Typical Characteristics: $V_S = \pm 5\text{ V}$ , OPA695IDBV, OPA695ID (continued)

at  $T_A = +25^\circ\text{C}$ ,  $G = +8\text{ V/V}$ ,  $R_F = 402\ \Omega$ , and  $R_L = 100\ \Omega$  (unless otherwise noted)

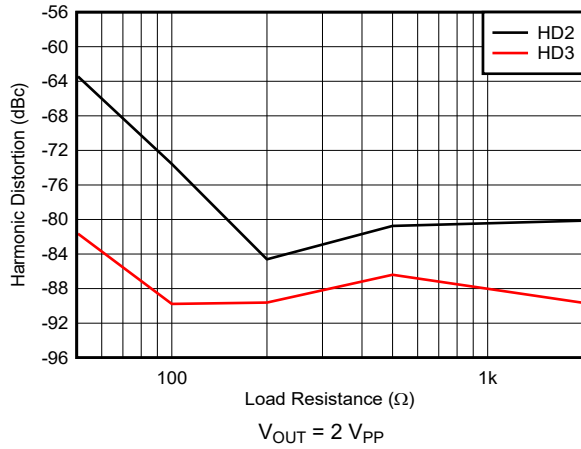

Figure 5-7. 10-MHz Harmonic Distortion vs Load Resistance

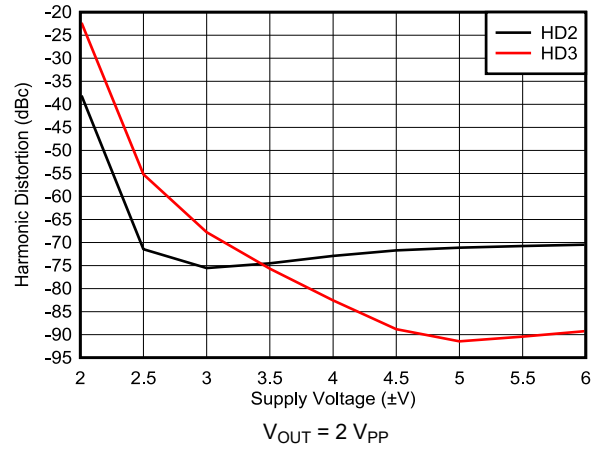

Figure 5-8. 10-MHz Harmonic Distortion vs Supply Voltage

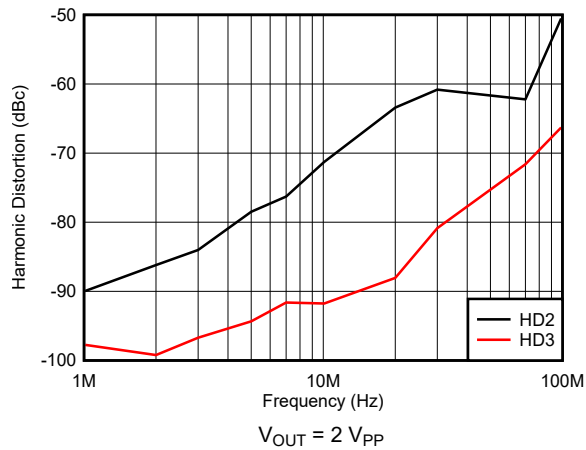

Figure 5-9. Harmonic Distortion vs Frequency

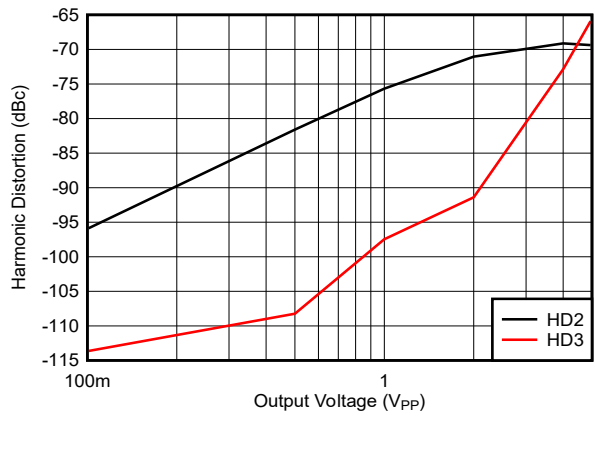

Figure 5-10. 10-MHz Harmonic Distortion vs Output Voltage

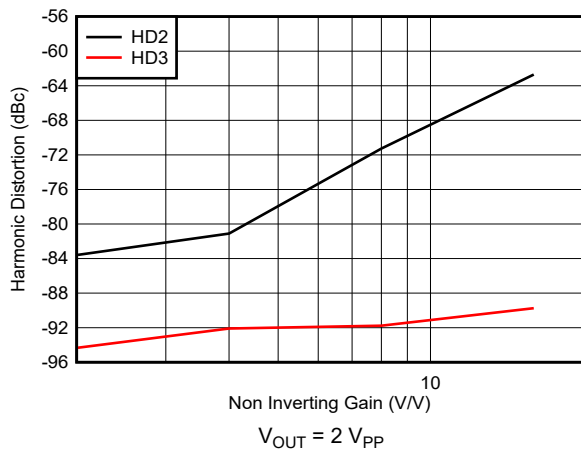

Figure 5-11. 10-MHz Harmonic Distortion vs Noninverting Gain

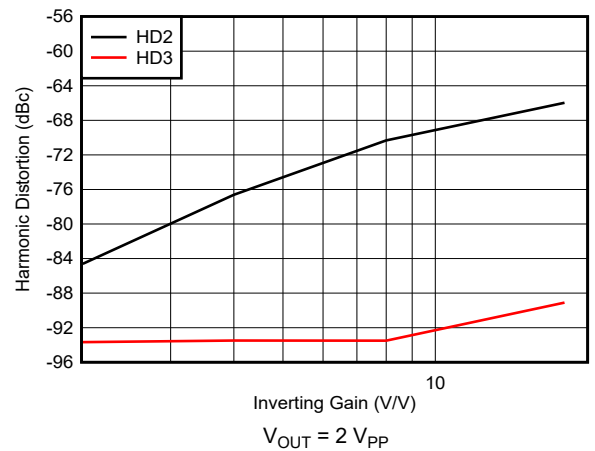

Figure 5-12. 10-MHz Harmonic Distortion vs Inverting Gain

### 5.9 Typical Characteristics: $V_S = \pm 5\text{ V}$ , OPA695IDBV, OPA695ID (continued)

at  $T_A = +25^\circ\text{C}$ ,  $G = +8\text{ V/V}$ ,  $R_F = 402\ \Omega$ , and  $R_L = 100\ \Omega$  (unless otherwise noted)

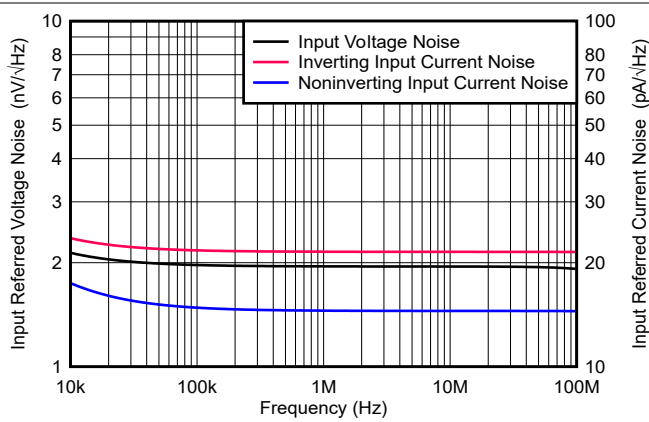

Figure 5-13. Input Voltage and Current Noise Density

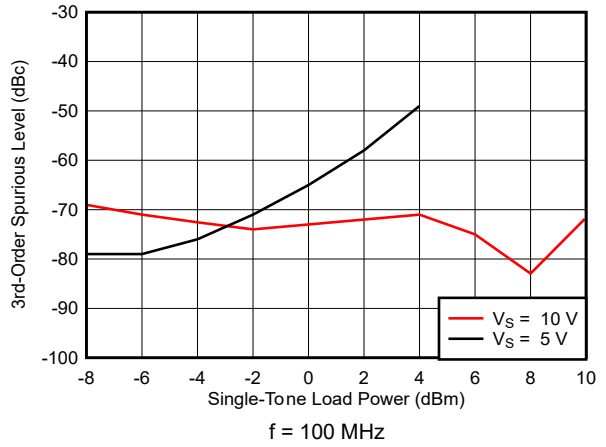

Figure 5-14. Two-Tone 3rd-Order Intermodulation Distortion vs Frequency

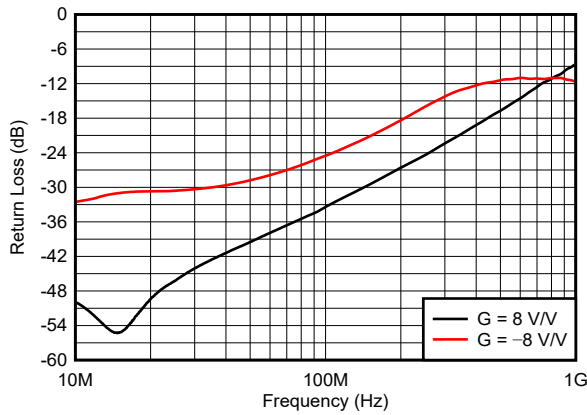

Figure 5-15. Input Return Loss vs Frequency ( $S_{11}$ )

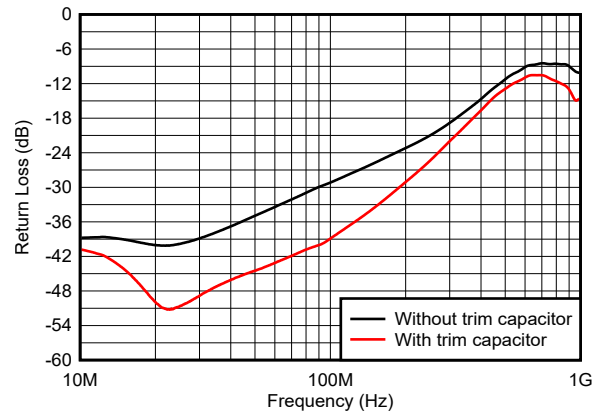

Figure 5-16. Output Return Loss vs Frequency ( $S_{22}$ )

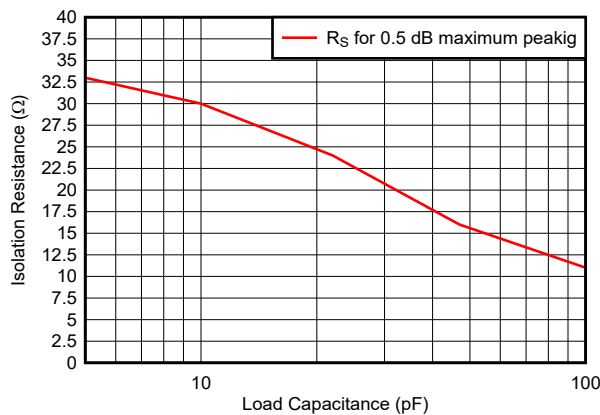

Figure 5-17.  $R_S$  vs Capacitive Load

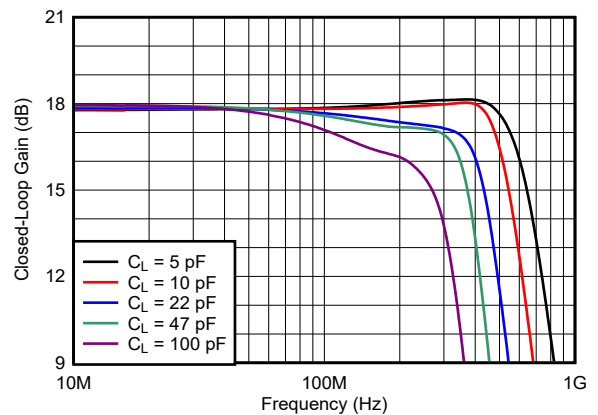

Figure 5-18. Small-Signal Frequency Response vs Capacitive Load

### 5.9 Typical Characteristics: $V_S = \pm 5\text{ V}$ , OPA695IDBV, OPA695ID (continued)

at  $T_A = +25^\circ\text{C}$ ,  $G = +8\text{ V/V}$ ,  $R_F = 402\ \Omega$ , and  $R_L = 100\ \Omega$  (unless otherwise noted)



图 5-19. CMRR and PSRR vs Frequency



图 5-20. Open-Loop Transimpedance Gain and Phase

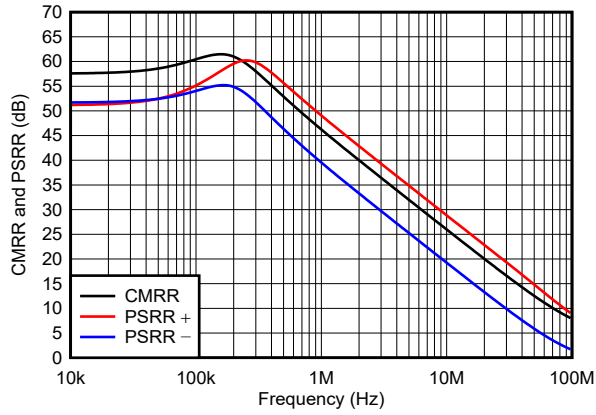

图 5-21. Output Voltage and Current Limitations

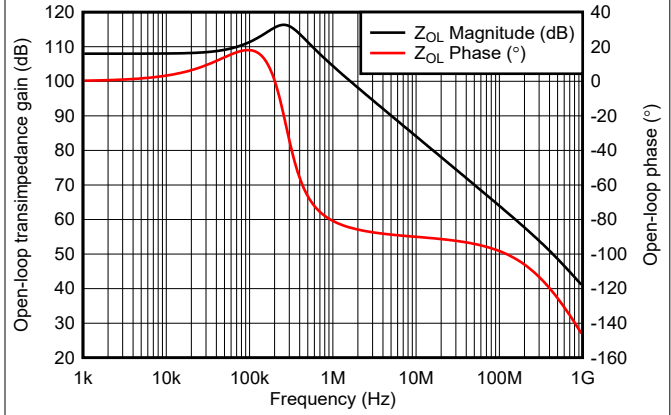

图 5-22. Supply and Output Current vs Temperature

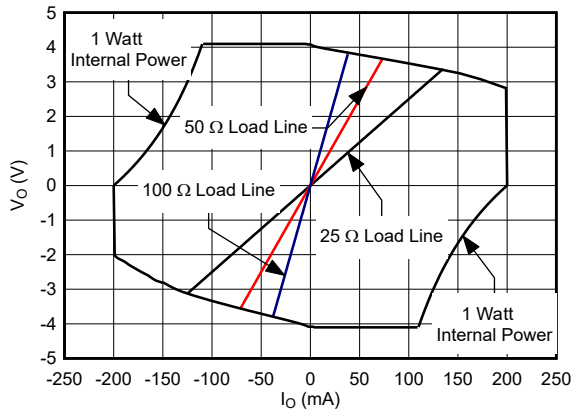

图 5-23. Noninverting Overdrive Recovery

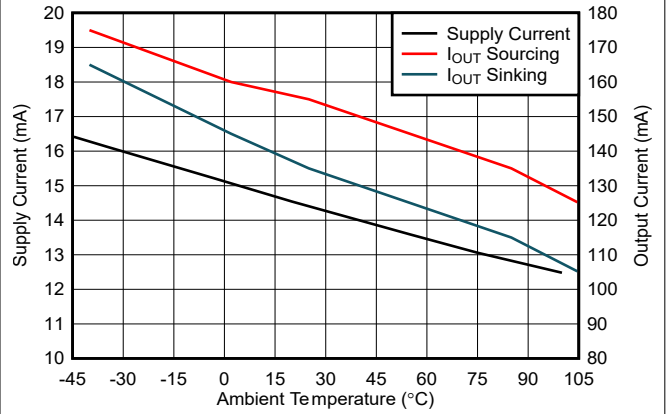

图 5-24. Inverting Overdrive Recovery

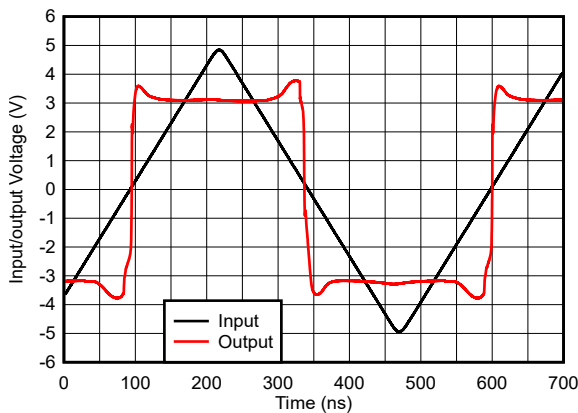

### 5.9 Typical Characteristics: $V_S = \pm 5\text{ V}$ , OPA695IDBV, OPA695ID (continued)

at  $T_A = +25^\circ\text{C}$ ,  $G = +8\text{ V/V}$ ,  $R_F = 402\ \Omega$ , and  $R_L = 100\ \Omega$  (unless otherwise noted)

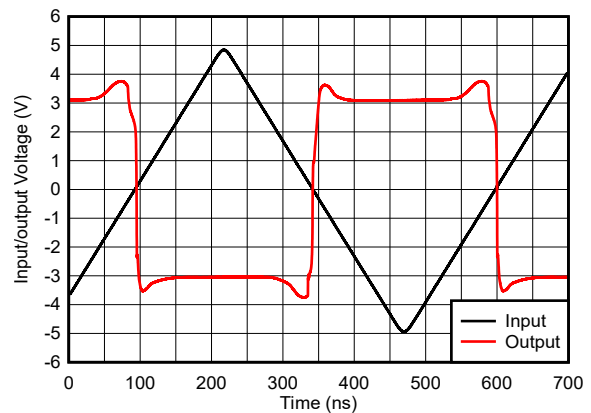
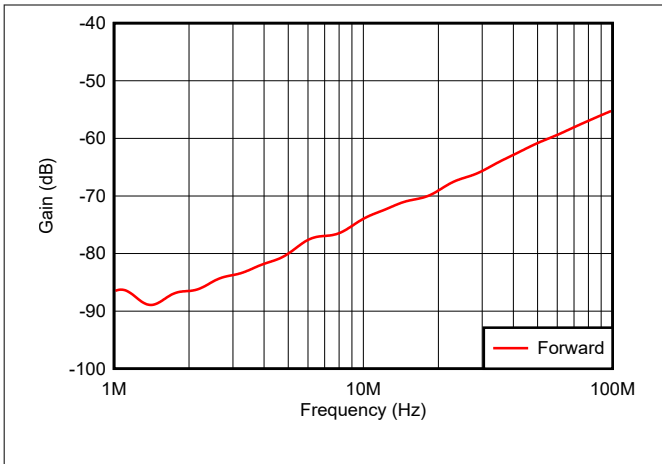

5-25. Disabled Feedthrough vs Frequency

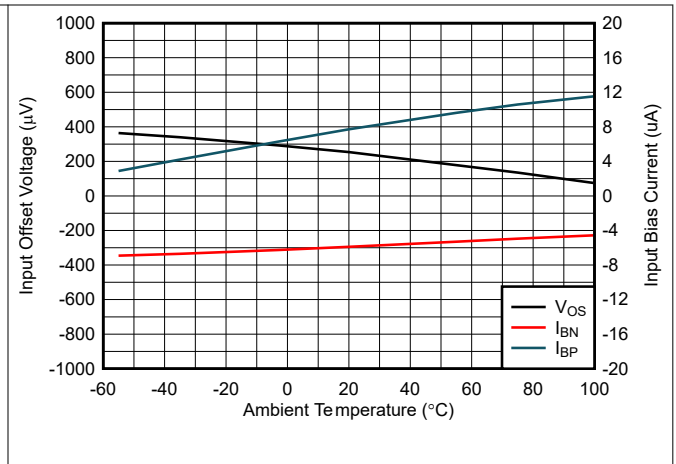

5-26. Typical DC Drift Over Temperature

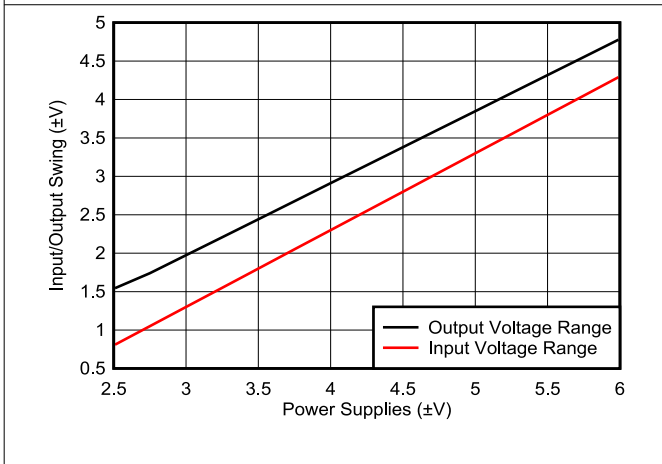

5-27. Common-Mode Input and Output Swing vs Supply Voltage

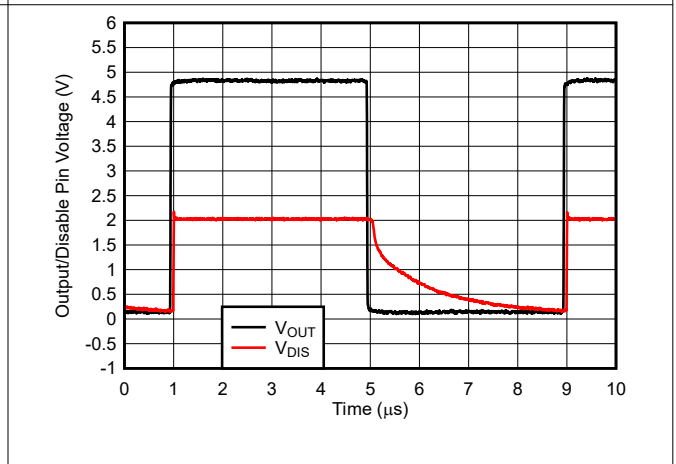

5-28. Large-Signal Disable and Enable Response

### 5.10 Typical Characteristics: $V_S = 5\text{ V}$ , OPA695IDBV, OPA695ID

at  $G = +8\text{ V/V}$ ,  $R_F = 348\ \Omega$ , and  $R_L = 100\ \Omega$  (unless otherwise noted)

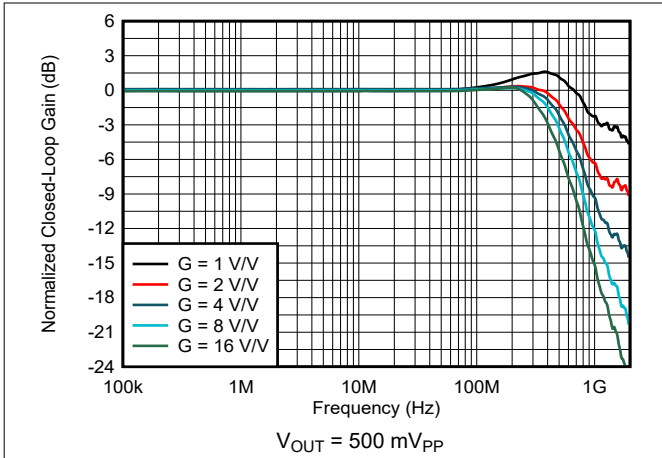

5-29. Noninverting Small-Signal Frequency Response

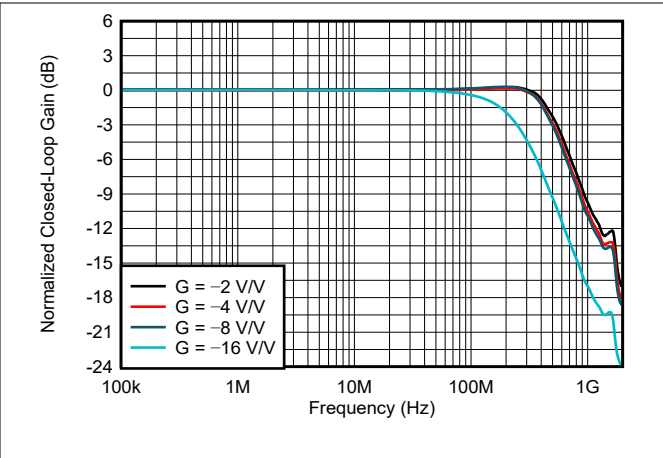

5-30. Inverting Small-Signal Frequency Response

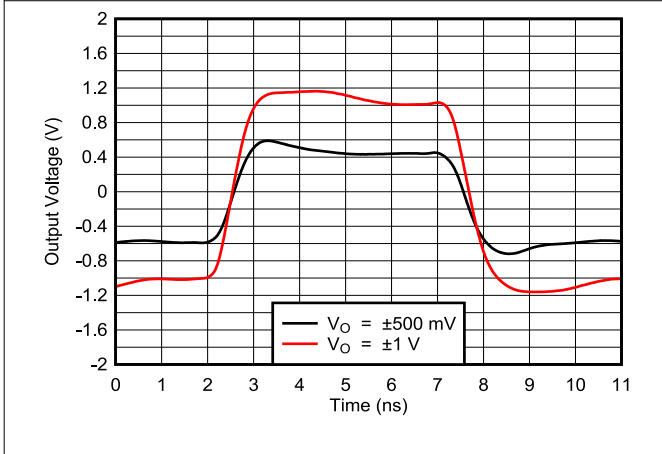

5-31. Noninverting Pulse Response

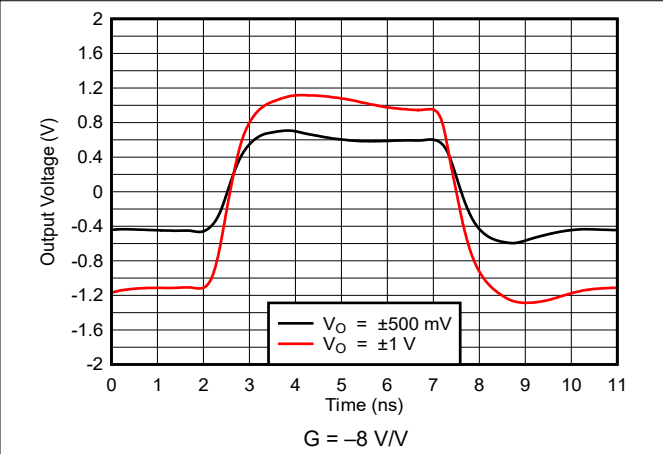

5-32. Inverting Pulse Response

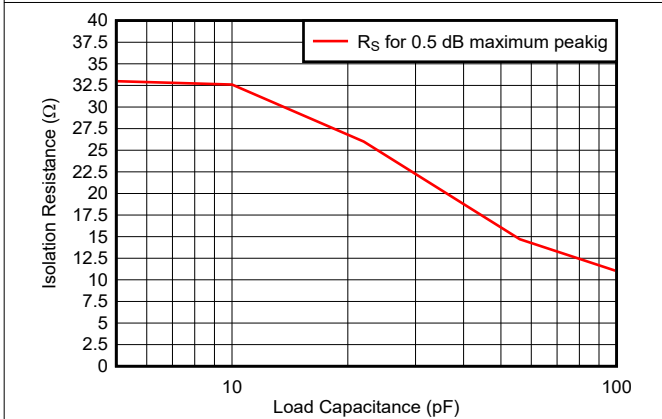

5-33.  $R_S$  vs Capacitive Load

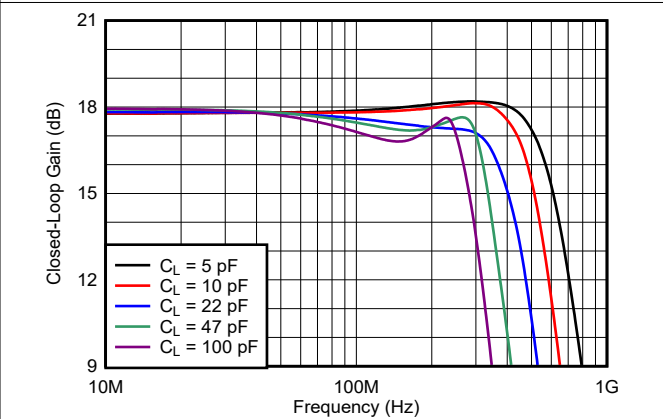

5-34. Small-Signal Frequency Response vs Capacitive Load

### 5.10 Typical Characteristics: $V_S = 5\text{ V}$ , OPA695IDBV, OPA695ID (continued)

at  $G = +8\text{ V/V}$ ,  $R_F = 348\ \Omega$ , and  $R_L = 100\ \Omega$  (unless otherwise noted)

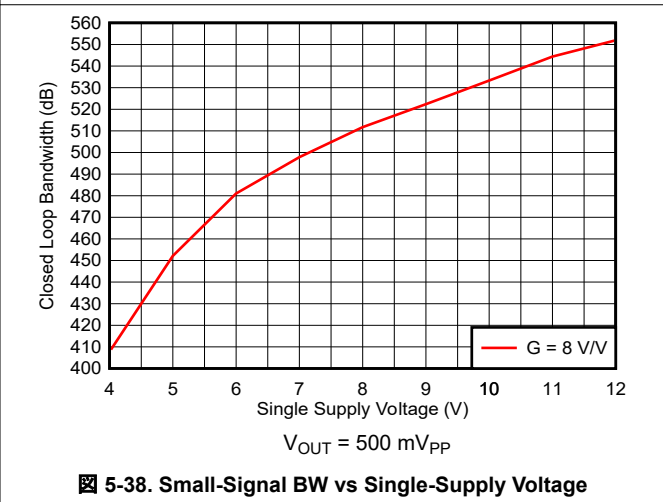
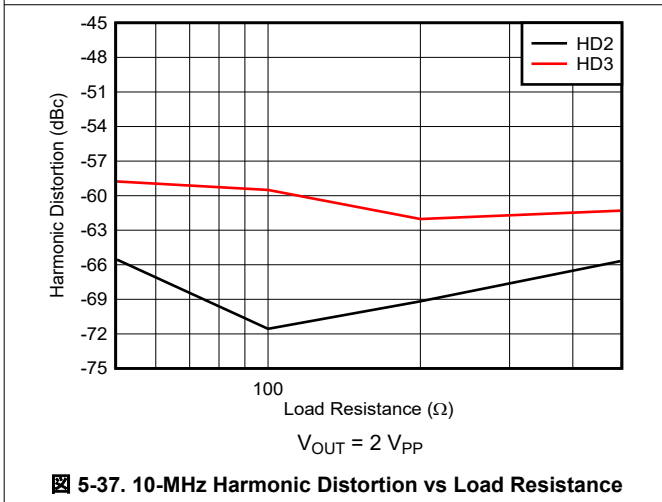
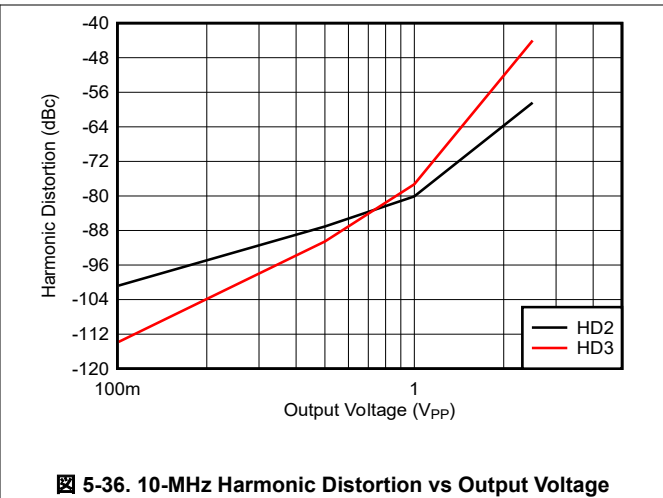
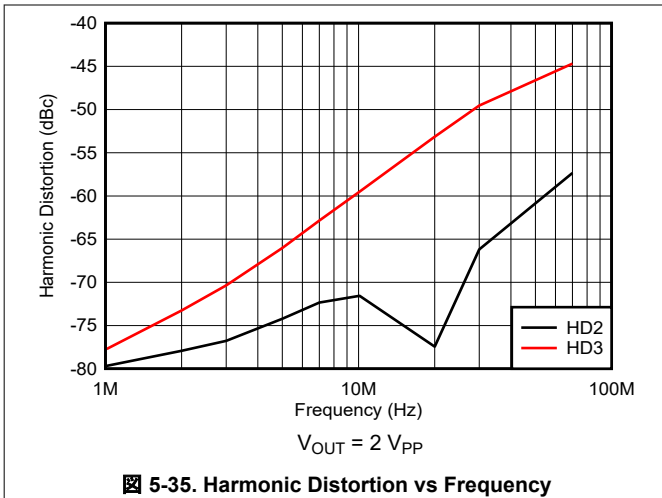

### 5.11 Typical Characteristics: $V_S = \pm 5\text{ V}$ , OPA695IDGK

at  $G = +8\text{ V/V}$ ,  $R_F = 402\ \Omega$ , and  $R_L = 100\ \Omega$  (unless otherwise noted)

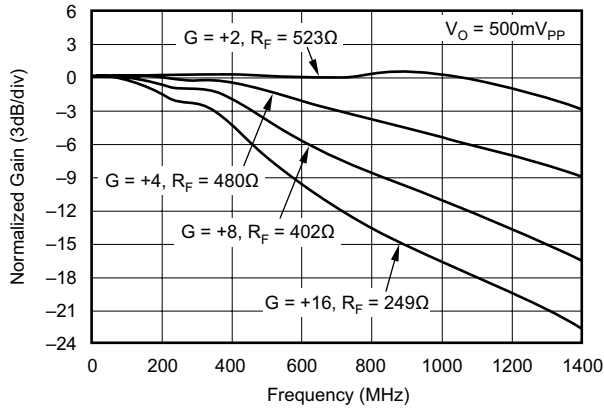

5-39. Noninverting Small-Signal Frequency Response

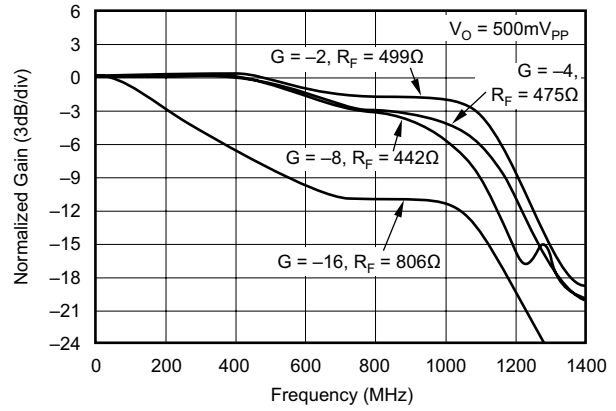

5-40. Inverting Small-Signal Frequency Response

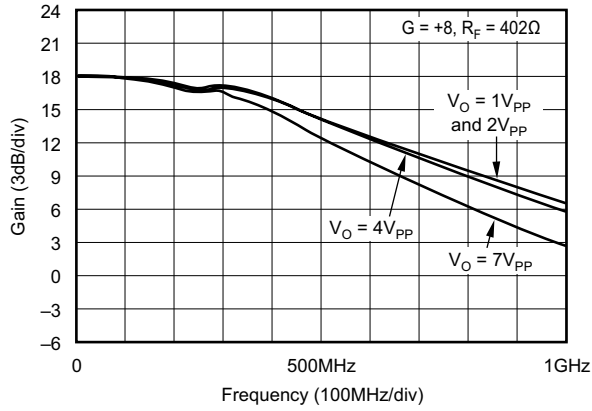

5-41. Noninverting Large-Signal Frequency Response

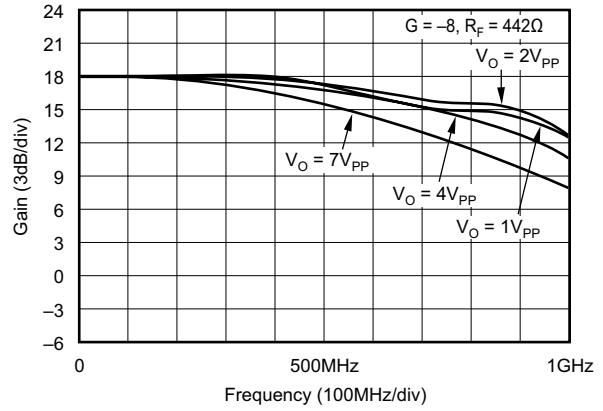

5-42. Inverting Large-Signal Frequency Response

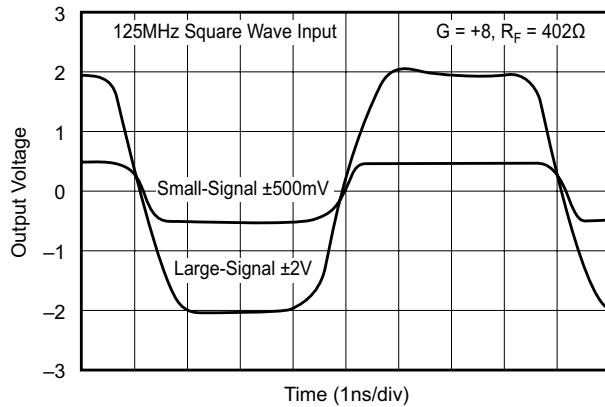

5-43. Noninverting Large- and Small-Signal Frequency Responses

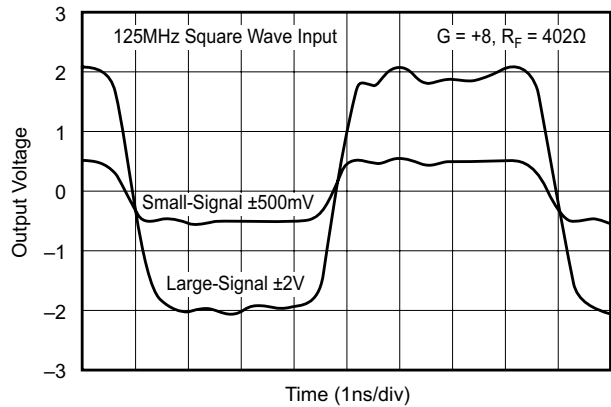

5-44. Inverting Large- and Small-Signal Frequency Responses

### 5.11 Typical Characteristics: $V_S = \pm 5\text{ V}$ , OPA695IDGK (continued)

at  $G = +8\text{ V/V}$ ,  $R_F = 402\ \Omega$ , and  $R_L = 100\ \Omega$  (unless otherwise noted)

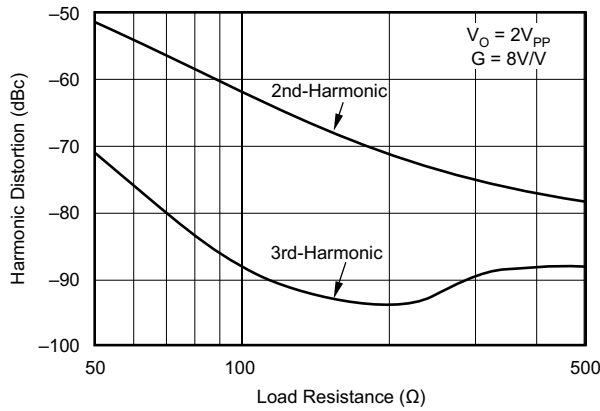

5-45. 10-MHz Harmonic Distortion vs Load Resistance

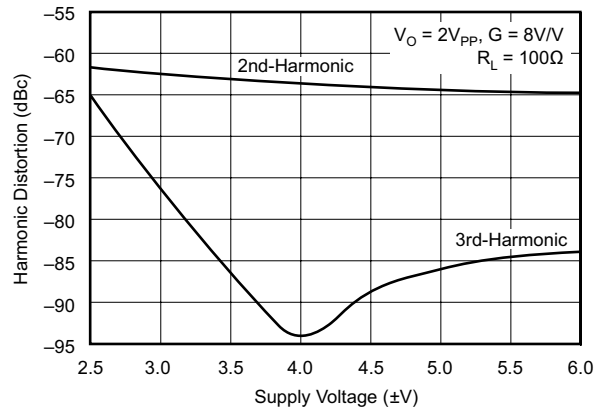

5-46. 10-MHz Harmonic Distortion vs Supply Voltage

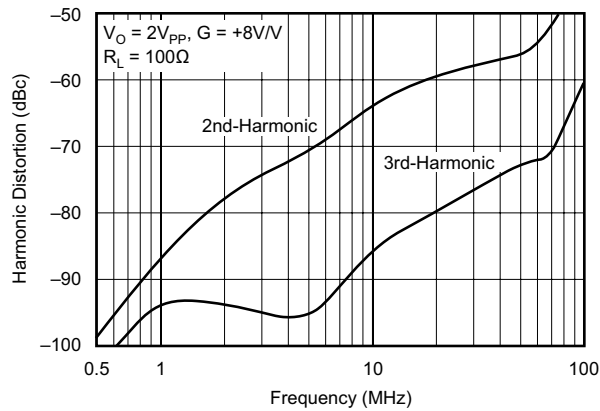

5-47. Harmonic Distortion vs Frequency

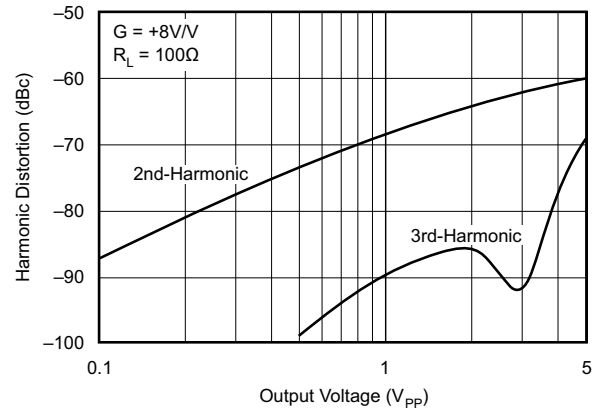

5-48. 10-MHz Harmonic Distortion vs Output Voltage

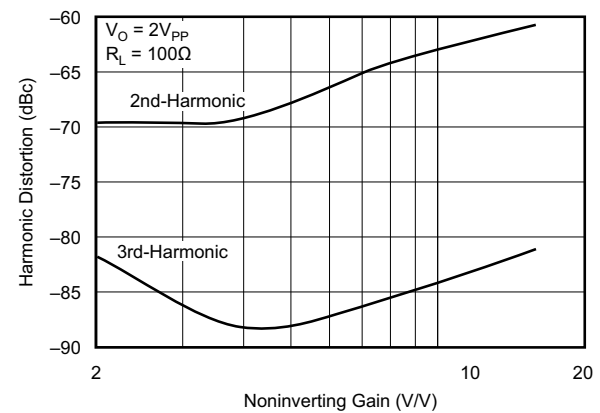

5-49. 10-MHz Harmonic Distortion vs Noninverting Gain

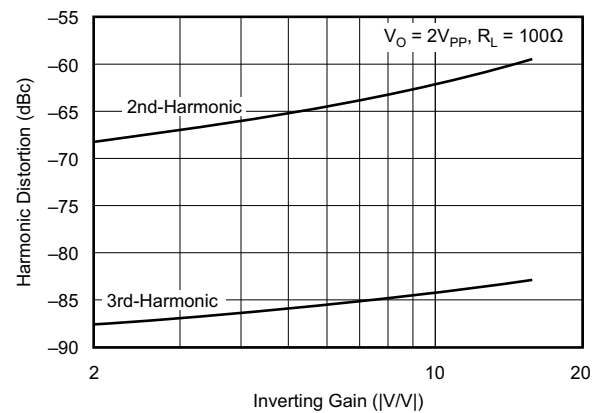

5-50. 10-MHz Harmonic Distortion vs Inverting Gain

### 5.11 Typical Characteristics: $V_S = \pm 5\text{ V}$ , OPA695IDGK (continued)

at  $G = +8\text{ V/V}$ ,  $R_F = 402\ \Omega$ , and  $R_L = 100\ \Omega$  (unless otherwise noted)



图 5-51. Input Voltage and Current Noise Density



图 5-52. Two-Tone 3rd-Order Intermodulation Intercept

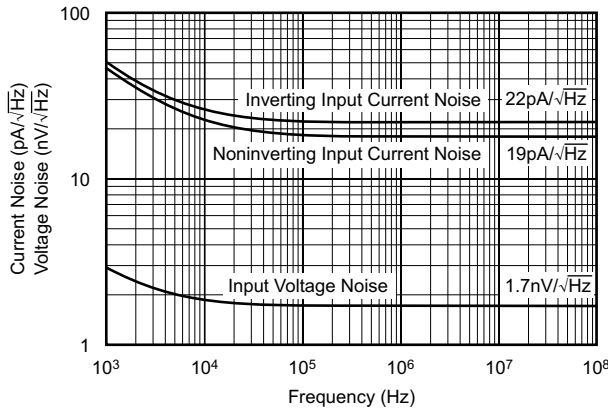

图 5-53. Input Return Loss vs Frequency ( $S_{11}$ )

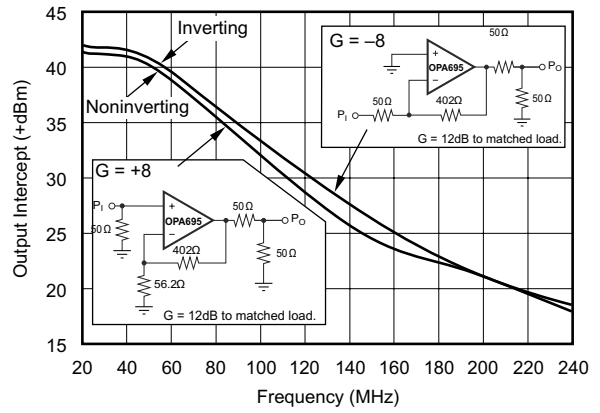

图 5-54. Output Return Loss vs Frequency ( $S_{22}$ )

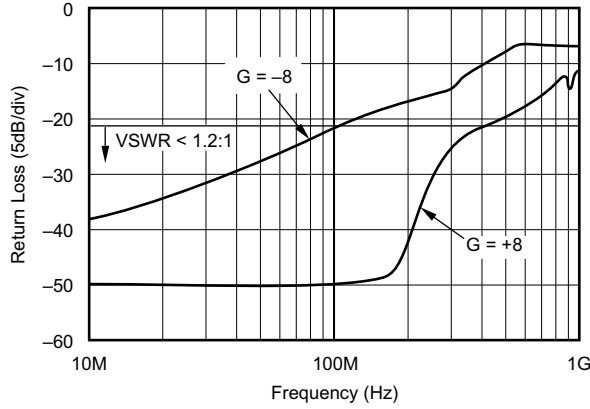

图 5-55.  $R_S$  vs Capacitive Load

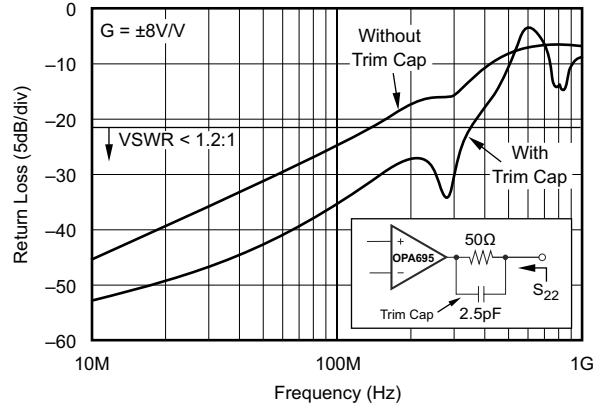

图 5-56. Small-Signal Frequency Response vs Capacitive Load

### 5.11 Typical Characteristics: $V_S = \pm 5\text{ V}$ , OPA695IDGK (continued)

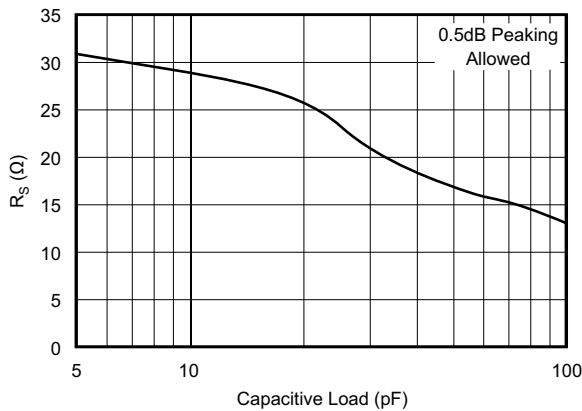
at  $G = +8\text{ V/V}$ ,  $R_F = 402\ \Omega$ , and  $R_L = 100\ \Omega$  (unless otherwise noted)

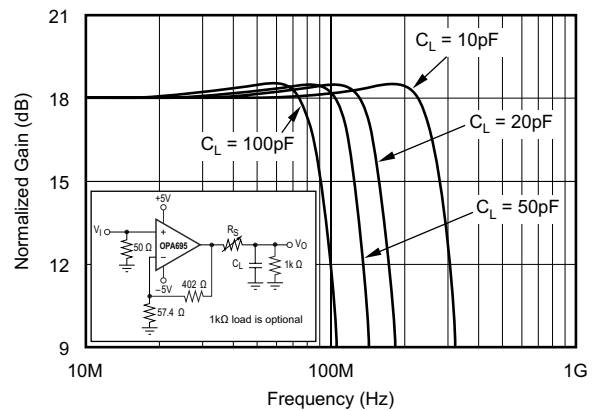
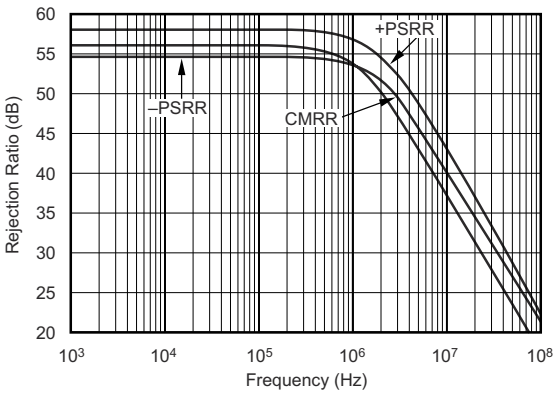

Figure 5-57. CMRR and PSRR vs Frequency

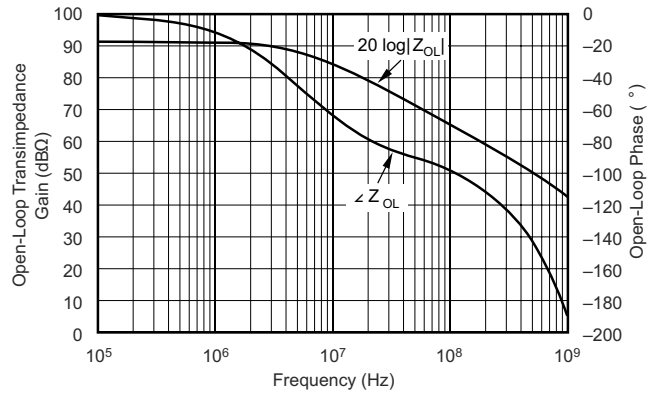

Figure 5-58. Open-Loop Transimpedance Gain and Phase

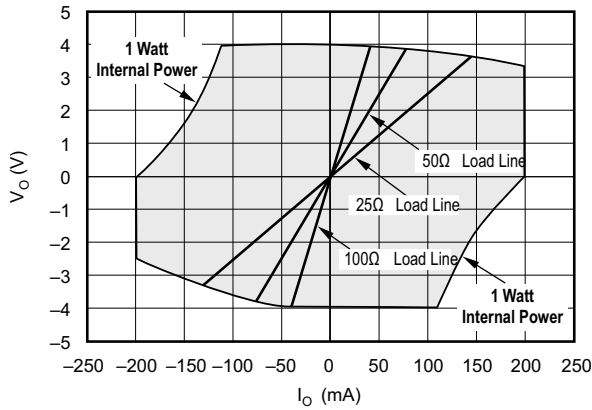

Figure 5-59. Output Voltage and Current Limitations

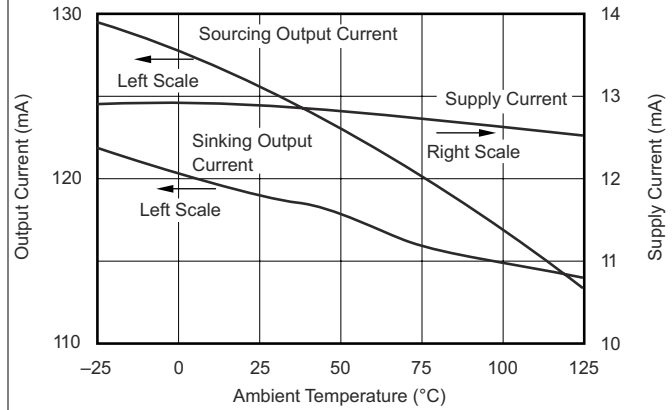

Figure 5-60. Supply and Output Current vs Temperature

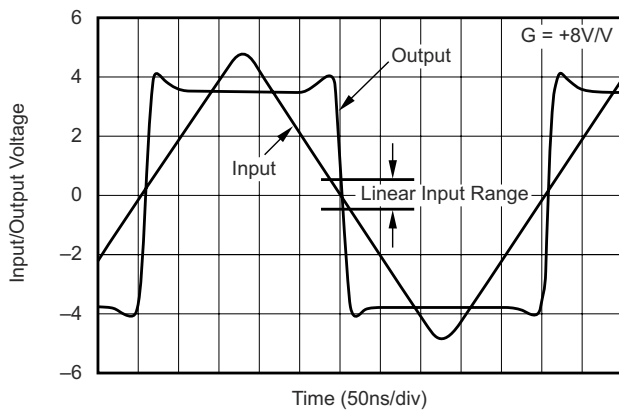

Figure 5-61. Noninverting Overdrive Recovery

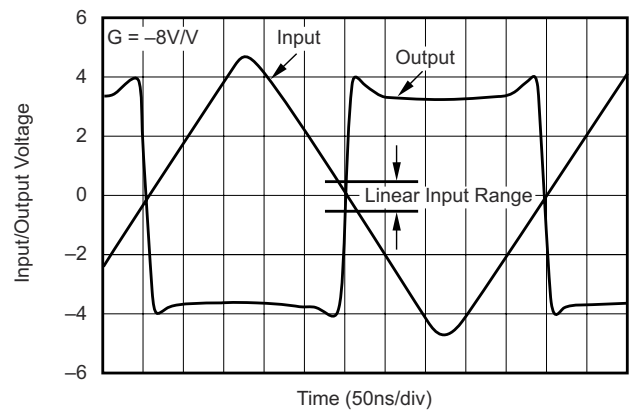

Figure 5-62. Inverting Overdrive Recovery

### 5.11 Typical Characteristics: $V_S = \pm 5\text{ V}$ , OPA695IDGK (continued)

at  $G = +8\text{ V/V}$ ,  $R_F = 402\ \Omega$ , and  $R_L = 100\ \Omega$  (unless otherwise noted)

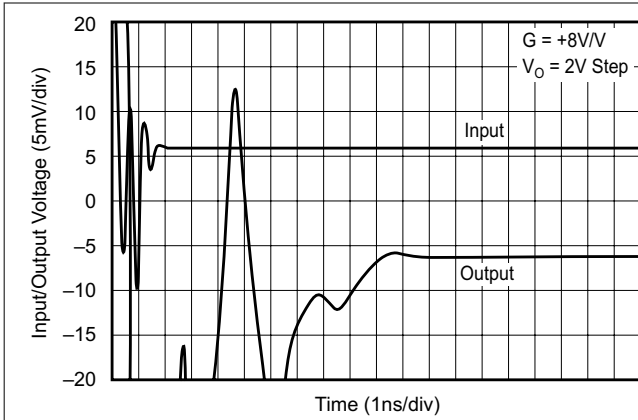

Figure 5-63. Settling Time

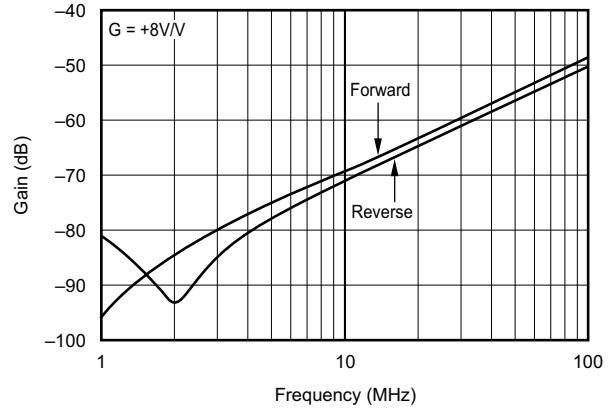

Figure 5-64. Disabled Feedthrough vs Frequency

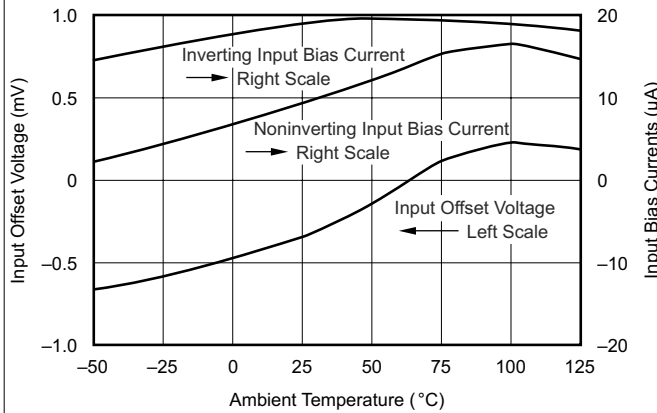

Figure 5-65. Typical DC Drift Over Temperature

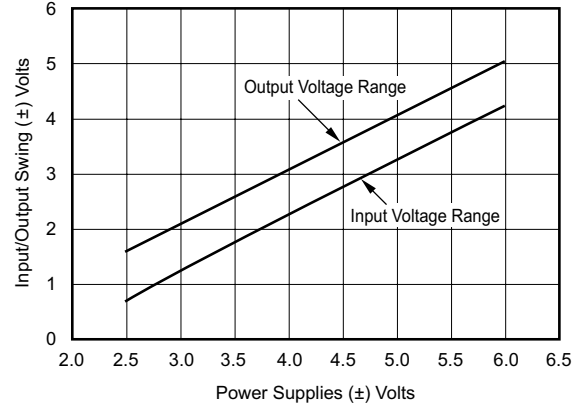

Figure 5-66. Common-Mode Input and Output Swing vs Supply Voltage

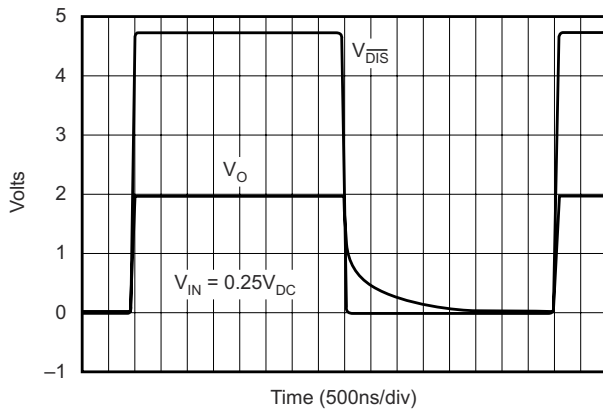

Figure 5-67. Large-Signal Disable and Enable Responses

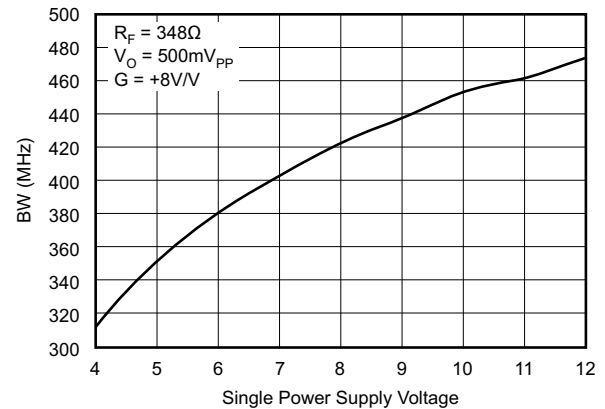

Figure 5-68. Small-Signal BW vs Single-Supply Voltage



### 5.12 Typical Characteristics: $V_S = 5\text{ V}$ , OPA695IDGK

at  $G = +8\text{ V/V}$ ,  $R_F = 348\ \Omega$ , and  $R_L = 100\ \Omega$  (unless otherwise noted)

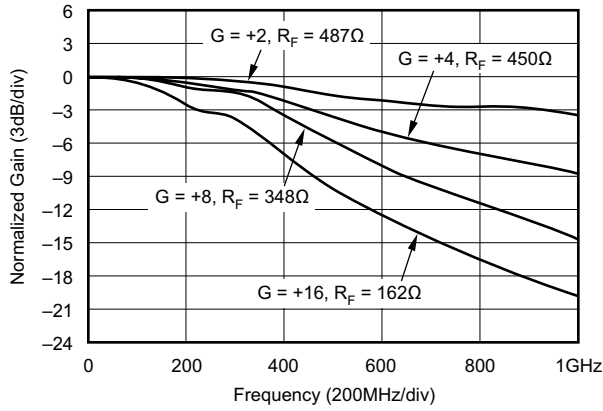

Figure 5-69. Noninverting Small-Signal Frequency Response

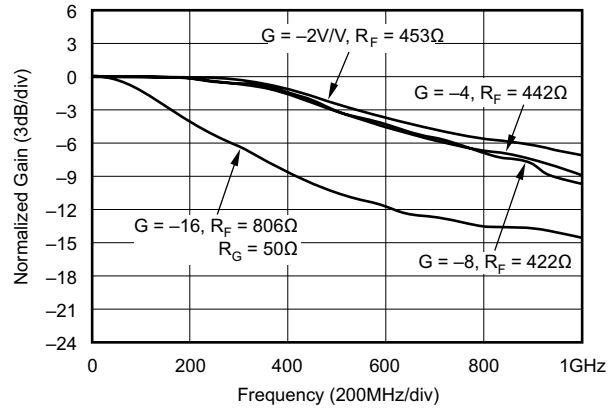

Figure 5-70. Inverting Small-Signal Frequency Response

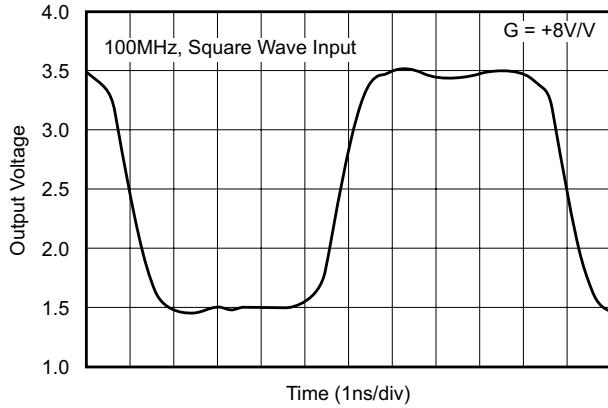

Figure 5-71. Noninverting Pulse Response

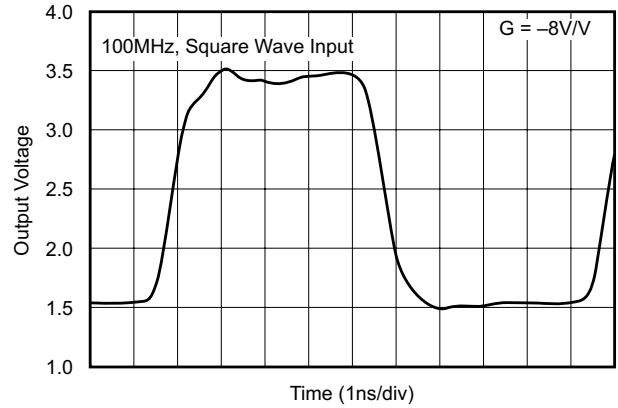

Figure 5-72. Inverting Pulse Response

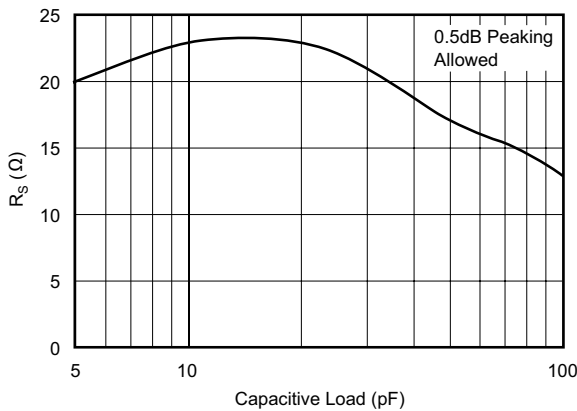

Figure 5-73.  $R_S$  vs Capacitive Load

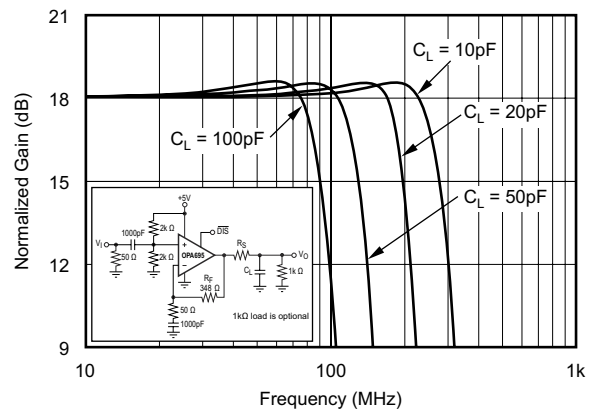
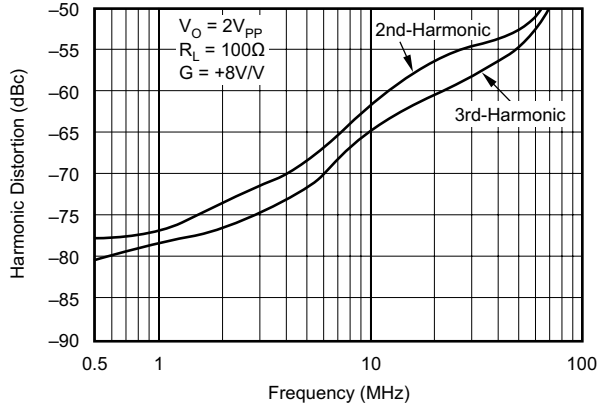

Figure 5-74. Small-Signal Frequency Response vs Capacitive Load

**5.12 Typical Characteristics:  $V_S = 5\text{ V}$ , OPA695IDGK (continued)**

at  $G = +8\text{ V/V}$ ,  $R_F = 348\ \Omega$ , and  $R_L = 100\ \Omega$  (unless otherwise noted)



**5-75. Harmonic Distortion vs Frequency**

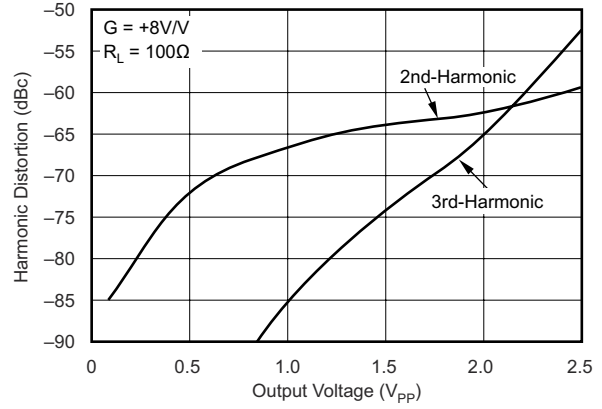

**5-76. 10-MHz Harmonic Distortion vs Output Voltage**

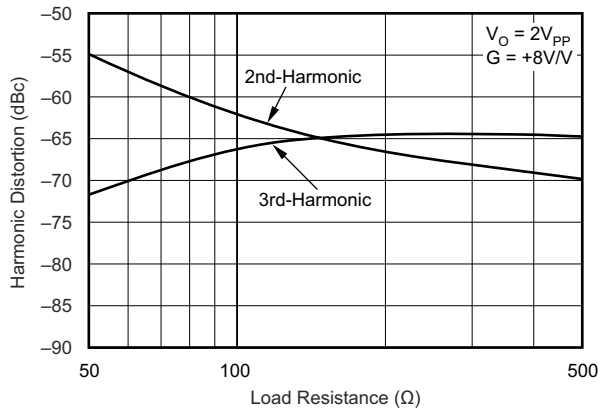

**5-77. 10-MHz Harmonic Distortion vs Load Resistance**

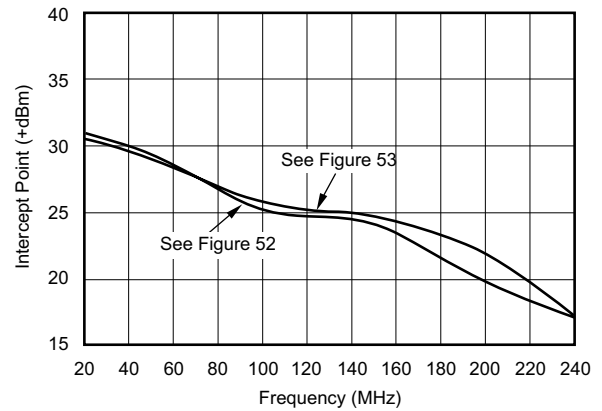

**5-78. Two-Tone, 3rd-Order Intermodulation Intercept**

## 6 Detailed Description

### 6.1 Overview

The OPA695 is a high-speed current-feedback amplifier (CFA) designed to operate over a wide supply range of  $\pm 2.5$  V (5 V) to  $\pm 6$  V (12 V) for applications requiring low distortion along with wide-bandwidth and high slew-rate. Common applications for current-feedback operational amplifiers include gain blocks in high-speed data-acquisition systems, coaxial cable drivers, analog-to-digital converter (ADC) drivers, and digital-to-analog converters (DAC) drivers. The OPA695 features a power-down pin that puts the amplifier in low-power standby mode and lowers the quiescent current from 14 mA to 160  $\mu$ A.

### 6.2 Functional Block Diagram

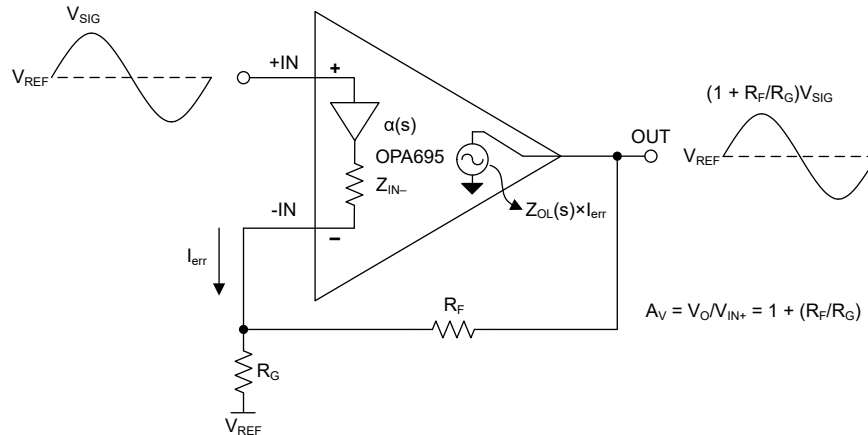

### 6.3 Feature Description

#### 6.3.1 Wideband Current-Feedback Operation

The OPA695 provides a new level of performance in wideband current-feedback operational amplifiers. The nearly constant ac performance over a wide gain range, along with 5000-V/ $\mu$ s slew rate and ultra-low distortion makes this device an excellent choice for high-speed data acquisition gain stages. While optimized at a gain of +8 V/V (12 dB to a matched 50- $\Omega$  load) to give 600-MHz bandwidth, applications from gains of 1 V/V to 40 V/V can be supported. At gains above 20 V/V, the signal bandwidth starts to decrease, but still exceeds 180 MHz up to a gain of 40 V/V (26 dB to a matched 50- $\Omega$  load). Single +5-V supply operation is also supported with similar bandwidths but reduced output power capability.

Figure 6-1 shows the dc-coupled, gain of +8 V/V, dual-power supply circuit used as the basis of the  $\pm 5$ -V specifications and typical characteristic curves. The total effective load is  $100 \Omega \parallel 458 \Omega = 82 \Omega$ . The disable control line ( $\overline{\text{DIS}}$ ) is typically left open for normal amplifier operation. Assert the disable line low to shut off the OPA695. Figure 6-2 shows the dc-coupled, gain of  $-8$  V/V, dual-power supply circuit used as the basis of the inverting typical characteristic curves. Inverting operation offers several performance benefits. There is no common-mode signal across the input stage; therefore, the distortion performance is slightly improved. In addition to the usual power-supply decoupling capacitors to ground, a 0.01- $\mu$ F capacitor is included between the two power-supply pins. In practical PCB layouts, this optional added capacitor typically improves the 2nd-harmonic distortion performance by 3 dB to 6 dB for bipolar-supply operation.



図 6-1. DC-Coupled,  $G = +8$  V/V, Bipolar Supply Specifications and Test Circuit



図 6-2. DC-Coupled,  $G = -8$  V/V, Bipolar Supply Specifications and Test Circuit

### 6.3.2 Input and ESD Protection

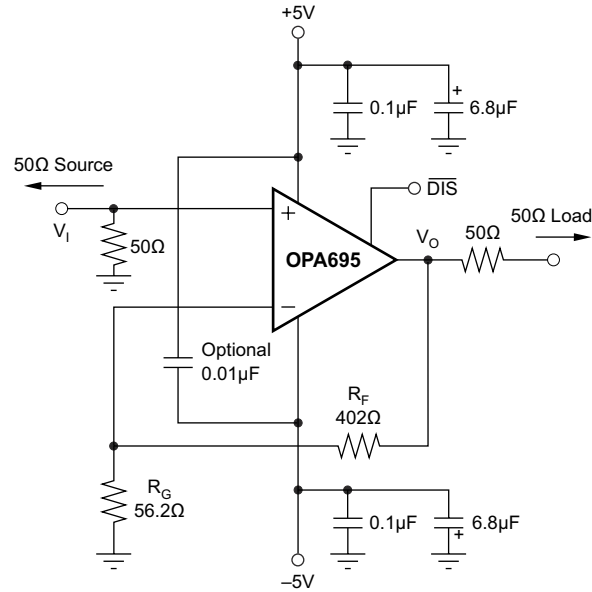
The OPA695 is built using a very high-speed, complementary bipolar process. The internal junction breakdown voltages are relatively low for these small geometry devices. These breakdowns are reflected in the [Absolute Maximum Ratings](#), where an absolute maximum  $\pm 6.5\text{-V}$  supply is reported. All device pins have limited ESD protection using internal diodes to the power supplies, as shown in [Figure 6-3](#).

These diodes also provide moderate protection to input overdrive voltages above the supplies. The protection diodes can typically support 10-mA continuous current. Where higher currents are possible (for example, in systems with  $\pm 15\text{-V}$  supply parts driving into the OPA695), add current-limiting series resistors into the two inputs. Keep these resistor values as low as possible because high values degrade both noise performance and frequency response.

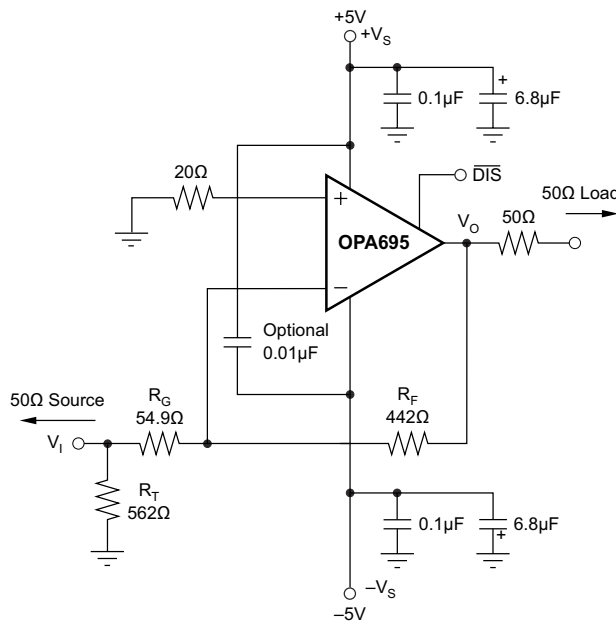
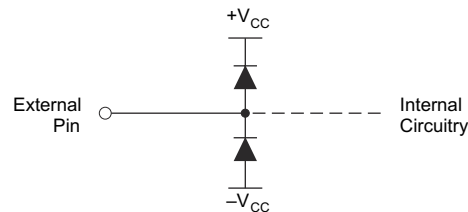

**Figure 6-3. Internal ESD Protection**

### 6.4 Device Functional Modes

The OPA695 has two functional modes: enabled and disabled. While operating on a bipolar supply of  $V_S = \pm 5\text{V}$  the first functional mode is accessed by applying a logic 1 ( $> 3.5\text{ V}$ ) to the  $\overline{\text{DIS}}$  pin. In this mode, the amplifier is fully enabled and draws a supply current of 14mA.

The second functional mode is the disabled state. The disabled state is accessed by applying a logic 0 ( $< 1.7\text{V}$ ) to the  $\overline{\text{DIS}}$  pin. In this mode, the amplifier is fully disabled and draws a current of only  $160\mu\text{A}$ . When disabled, the output and input nodes go to a high-impedance state. When the OPA695 operates in a gain of  $+1\text{V/V}$ , a very high impedance at the output and exceptional signal isolation occur. When operating at a gain greater than  $+1\text{V/V}$ , the total feedback network resistance appears as an impedance at the output, but the circuit still shows very high forward and reverse isolation. If configured as an inverting amplifier, the input and output are connected through the feedback network resistance, giving relatively poor input-to-output isolation.

## 7 Application and Implementation

### 注

以下のアプリケーション情報は、TI の製品仕様に含まれるものではなく、TI ではその正確性または完全性を保証いたしません。個々の目的に対する製品の適合性については、お客様の責任で判断していただくこととなります。お客様は自身の設計実装を検証しテストすることで、システムの機能を確認する必要があります。

### 7.1 Application Information

#### 7.1.1 Operating Suggestions

##### 7.1.1.1 Setting Resistor Values to Optimize Bandwidth

A current-feedback operational amplifier such as the OPA695 can hold an almost constant bandwidth over signal gain settings with the proper adjustment of the external resistor values. [セクション 5.9](#) shows this feature. The small-signal bandwidth decreases only slightly with increasing gain. These curves also show that the feedback resistor has been changed for each gain setting. The absolute values of  $R_F$  on the inverting side of the circuit for a current-feedback operational amplifier can be treated as frequency response compensation elements, whereas the ratios of  $R_F$  and  $R_G$  set the signal gain. [図 7-1](#) shows the analysis circuit for the OPA695 small-signal frequency response.

The key elements of this current feedback operational amplifier model are:

- $\alpha \Rightarrow$  Buffer gain from the noninverting input to the inverting input.
- $R_I \Rightarrow$  Buffer output impedance
- $i_{ERR} \Rightarrow$  Feedback error current signal
- $Z(s) \Rightarrow$  Frequency-dependent, open-loop transimpedance gain from  $i_{ERR}$  to  $V_O$

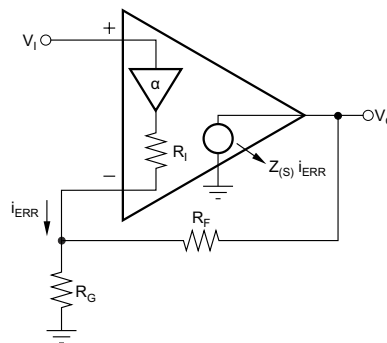

**図 7-1. Current-Feedback Transfer Function Analysis Circuit**

A current-feedback operational amplifier senses an error current in the inverting node (as opposed to a differential input error voltage for a voltage-feedback operational amplifier) and passes this on to the output through an internal frequency-dependent transimpedance gain. [セクション 5.9](#) show this open-loop transimpedance response. This is analogous to the open-loop voltage gain curve for a voltage-feedback operational amplifier. Refer to the training videos shown in [TI Precision Labs](#) for further understanding on the CFA operating theory

The values for  $R_F$  versus gain shown in [図 7-2](#) are approximately equal to the values used to generate the typical characteristics and give a good starting point for designs where bandwidth optimization is desired.



図 7-2. Recommended Feedback Resistor vs Noise Gain

### 7.1.1.2 Output Current and Voltage

The OPA695 provides output voltage and current capabilities consistent with driving doubly-terminated 50-Ω lines. For a 100-Ω load at a gain of +8 V/V (see 図 6-1), the total load is the parallel combination of the 100-Ω load and the 456-Ω total feedback network impedance. This 82-Ω load requires no more than 45 mA of output current to support the ±3.7-V minimum output voltage swing specified for 100-Ω loads. This value is much less than the minimum ±100-mA specifications.

For the specifications described previously, consider voltage and current limits separately. In many applications, the voltage times the current (or V-I product) is more relevant to circuit operation; see also 図 5-21. The X and Y axes of this graph show the zero-voltage output current limit and the zero-current output voltage limit, respectively. The four quadrants provide a more detailed view of the OPA695 output drive capabilities. Superimposing resistor load lines onto the plot shows the available output voltage and current for specific loads.

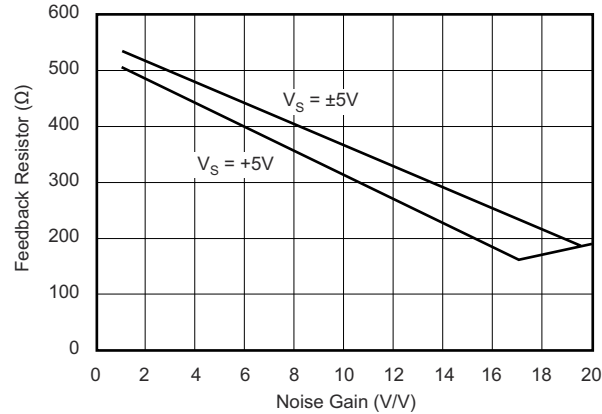
To maintain maximum output-stage linearity, no output short-circuit protection is provided. No short-circuit protection is not normally a problem, as most applications include a series-matching resistor at the output that limits the internal power dissipation if the output side of this resistor is shorted to ground.

However, shorting the output pin directly to the adjacent positive power supply pin, in most cases, destroys the amplifier. If additional short-circuit protection is required, consider a small series resistor in the power-supply leads. Under heavy output loads, this series resistor reduces the available output voltage swing. A 5-Ω series resistor in each power-supply lead limits the internal power dissipation to less than 1 W for an output short circuit, while decreasing the available output voltage swing only 0.25 V for up to 50-mA desired load currents. Always place the 0.1-μF power supply decoupling capacitors directly on the supply pins after these supply current-limiting resistors.

### 7.1.1.3 Driving Capacitive Loads

One of the most demanding, and yet very common, load conditions for an operational amplifier is capacitive loading. Often, the capacitive load is the input of an ADC, including additional external capacitance that can be recommended to improve ADC linearity. A high-speed, high-open-loop-gain amplifier like the OPA695 can be susceptible to decreased stability and closed-loop response peaking when a capacitive load is placed directly on the output pin. When the open-loop output resistance of the amplifier is considered, this capacitive load introduces an additional pole in the signal path that can decrease the phase margin. Several external solutions to this problem have been suggested. When the primary considerations are frequency response flatness, pulse response fidelity, and distortion, the simplest and most effective solution is to isolate the capacitive load ( $C_L$ ) from the feedback loop by inserting a series isolation resistor ( $R_{ISO}$ ) between the amplifier output and the capacitive load. [Figure 7-3](#) shows this configuration. This configuration does not eliminate the pole from the loop response, but shifts the pole and adds a zero at a higher frequency. The additional zero acts to cancel the phase lag from the capacitive load pole, thus increasing the phase margin and improving stability.

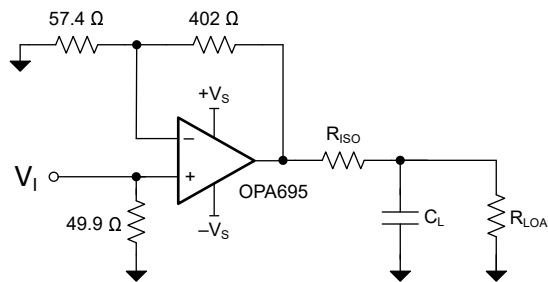

**Figure 7-3. Driving a Large Capacitive Load Using an Output Series Isolation Resistor**

The *Typical Characteristics* show the recommended  $R_S$  versus capacitive load and the resulting frequency response at the load. Parasitic capacitive loads greater than 2 pF can begin to degrade the performance of the OPA695. Long PCB traces, unmatched cables, and connections to multiple devices can exceed this value. Always consider this effect carefully and add the recommended series resistor as close as possible to the OPA695 output pin (see [セクション 7.4.1](#)).

### 7.1.1.4 Distortion Performance

The OPA695 provides good distortion performance into a 100-Ω load on  $\pm 5$ -V supplies. Compared to other devices, the OPA695 holds lower distortion at higher frequencies ( $> 20$  MHz). Generally, until the fundamental signal reaches very high frequency or power levels, the 2nd-harmonic dominates the distortion with a negligible 3rd-harmonic component. Focusing on the 2nd-harmonic, increasing the load impedance directly improves distortion; the total load includes the feedback network. In the noninverting configuration (see [Figure 6-1](#)), this feedback network load is the sum of  $R_F + R_G$ , while in the inverting configuration, the feedback network load is only  $R_F$ . Also, providing an additional supply decoupling capacitor (0.01  $\mu$ F) between the supply pins (for bipolar operation) improves the 2nd-order distortion.



### 7.1.1.5 Noise Performance

The OPA695 offers an excellent balance between voltage and current noise terms to achieve low output noise. The inverting current noise (22 pA/√Hz) is lower than most other current-feedback operational amplifiers, while the input voltage noise (1.8 nV/√Hz) is lower than any unity-gain stable, wideband, voltage-feedback operational amplifier. This low-input voltage noise was achieved at the price of a higher noninverting input current noise (18 pA/√Hz). As long as the ac source impedance looking out of the noninverting node is less than 50 Ω, this current noise does not contribute significantly to the total output noise. The operational amplifier input voltage noise and the two input current noise terms combine to give low output noise under a wide variety of operating conditions. [Figure 7-4](#) shows the operational amplifier noise analysis model with all the noise terms included. In this model, all noise terms are taken to be noise voltage or current density terms in either nV/√Hz or pA/√Hz.

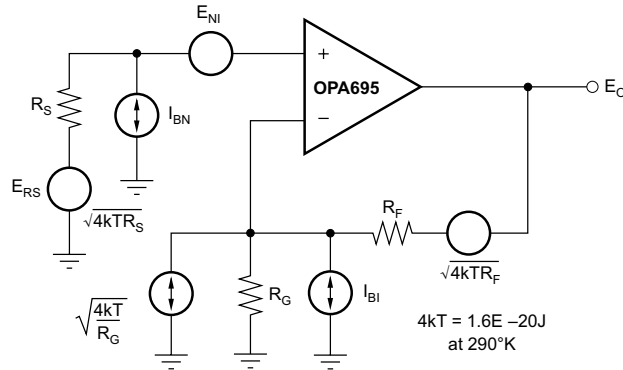

**Figure 7-4. Operational Amplifier Noise Figure Analysis Model**

The total output spot-noise voltage can be computed as the square root of the sum of all squared output noise voltage contributors. [Equation 1](#) shows the general form for the output noise voltage using the terms shown in [Figure 7-8](#).

$$E_O = \sqrt{\left(E_{NI}^2 + (I_{BN}R_S)^2 + 4kTR_S\right) G_N^2 + (I_{BI}R_F)^2 + 4kTR_F G_N} \quad (1)$$

Dividing this expression by the noise gain ( $NG = (1 + R_F/R_G)$ ) gives the equivalent input referred spot-noise voltage at the noninverting input, as shown in [Equation 2](#):

$$E_N = \sqrt{E_{NI}^2 + (I_{BN}R_S)^2 + 4kTR_S + \left(\frac{I_{BI}R_F}{NG}\right)^2 + \frac{4kTR_F}{NG}} \quad (2)$$

Evaluating these two equations for the OPA695 circuit and component values shown in [Figure 6-1](#) gives a total output spot-noise voltage of 18.7 nV/√Hz and a total equivalent input spot-noise voltage of 2.3 nV/√Hz. This total input referred spot-noise voltage is higher than the 1.8-nV/√Hz specification for the operational amplifier voltage noise alone. This reflects the noise added to the output by the inverting current noise times the feedback resistor. If the feedback resistor is reduced in high-gain configurations (as suggested previously), the total input referred voltage noise given by [Equation 2](#) just approaches the 1.8 nV/√Hz of the operational amplifier. For example, going to a gain of +20 (using  $R_F = 200 \Omega$ ) gives a total input referred noise of 2.0 nV/√Hz.

For a more complete discussion of operational amplifier noise calculation, see the [Noise Analysis for High Speed Op Amps application note](#), available through [www.ti.com](http://www.ti.com).

### 7.1.1.6 Thermal Analysis

The OPA695 does not require an additional heat sink for most applications. The maximum desired junction temperature sets the maximum allowed internal power dissipation as described in this section. Do not exceed the maximum junction temperature of 150°C.

Operating junction temperature ( $T_J$ ) is given by  $T_A + P_D \times \theta_{JA}$ . The total internal power dissipation ( $P_D$ ) is the sum of quiescent power ( $P_{DQ}$ ) and additional power dissipated in the output stage ( $P_{DL}$ ) to deliver load power. Quiescent power is simply the specified no-load supply current times the total supply voltage across the device.  $P_{DL}$  depends on the required output signal and load. However, for a grounded resistive load,  $P_{DL}$  is at a maximum when the output is fixed at a voltage equal to one-half of either supply voltage (for equal bipolar supplies). Under this condition,  $P_{DL} = V_S^2 / (4 \times R_L)$ , where  $R_L$  includes feedback network loading.

Note that the power in the output stage and not into the load determines internal power dissipation.

As an absolute worst-case example, compute the maximum  $T_J$  using an OPA695IDBV (SOT23-6 package) in the circuit of [Figure 6-1](#) operating at the maximum specified ambient temperature of +85°C and driving a grounded 100-Ω load.

$$P_D = 10 \text{ V} \times 14.1 \text{ mA} + 52 / (4 \times (100 \text{ } \Omega \parallel 458 \text{ } \Omega)) = 217 \text{ mW} \quad (3)$$

$$\text{Maximum } T_J = +85^\circ\text{C} + (0.22 \text{ W} \times 150^\circ\text{C/W}) = 118^\circ\text{C} \quad (4)$$

This maximum operating junction temperature is much less than most system level targets. Most applications are lower as an absolute worst-case output stage power was assumed in this calculation.

### 7.1.2 LO Buffer Amplifier

The OPA695 can also be used to buffer the local oscillator (LO) from the mixer. Operating at a voltage gain of +2 V/V, the OPA695 provides excellent load isolation for the LO, with a net gain of 0 dB to the mixer. Applications through a 1.4-GHz LO can be considered, but best operation is for an LO < 1.0 GHz at a gain of +2 V/V. Gain can also be provided by the OPA695 to drive higher power levels into the mixer. [Figure 7-5](#) shows one option for the OPA695 as an LO buffer. The OPA695 can drive multiple output loads; therefore, two identical LO signals can be delivered to the mixers in a diversity receiver by tapping the output off through two series 50-Ω output resistors. This circuit is set up for a voltage gain of +2 V/V to the output pin for a gain of +1 V/V (0 dB) to the mixers, but can be easily adjusted to deliver higher gains.

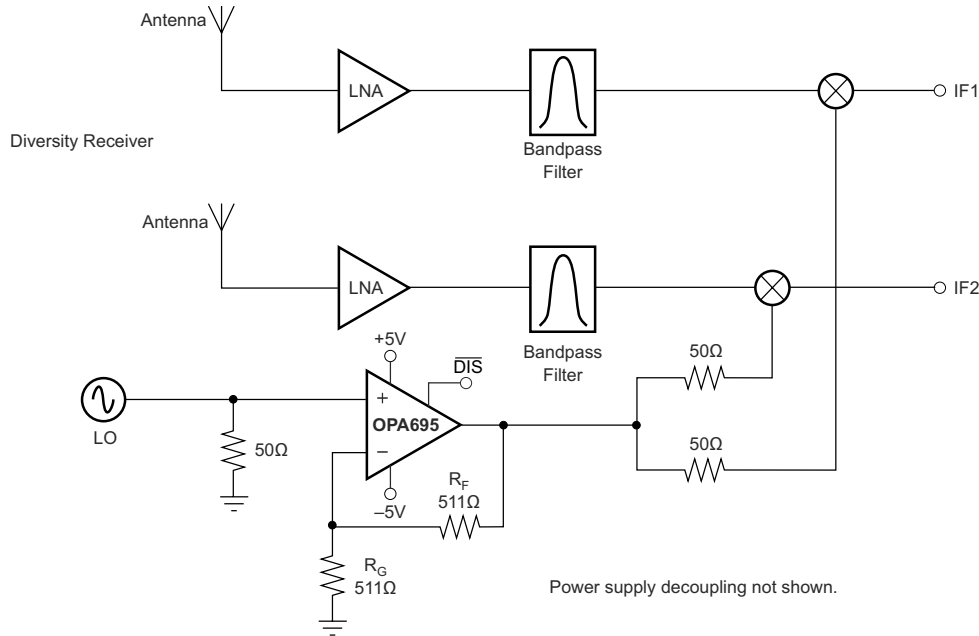

7-5. Dual Output LO Buffer

### 7.1.3 Wideband Cable Driving Applications

The high slew rate and bandwidth of the OPA695 can be used to meet the most demanding cable driving applications.

#### 7.1.3.1 Cable Modem Return Path Driver

The standard cable modem upstream driver is typically required to drive high power over a 5-MHz to 65-MHz bandwidth while delivering  $< -50$ -dBc distortion. Highly-integrated solutions (including programmable gain stages) often fall short of this target as a result of high losses from the amplifier output to the line. The higher gain-operating capability of the OPA695 and the very high slew rate provide a low-cost device for delivering this signal with the required spurious-free dynamic range. 7-6 shows one example of using the OPA695 as an upstream driver for a cable modem return path. In this case, the input impedance of the driver is set to  $75\ \Omega$  by the gain resistor ( $R_G$ ). The required input level from the adjustable gain stage is significantly reduced by the 15.5-dB gain provided by the OPA695. In this example, the physical  $75\text{-}\Omega$  output matching resistor, along with the 3-dB loss in the diplexer, attenuate the output swing by 9 dB on the line. In this example, a single +12-V supply is used to achieve the lowest harmonic distortion for the  $6\text{-}V_{PP}$  output pin voltage through 65 MHz. Measured performance for this example gives a 600-MHz small-signal bandwidth and  $< -54$ -dBc distortion through 65 MHz for a  $6\text{-}V_{PP}$  output pin voltage swing.

An alternative to this circuit that gives even lower distortion is a differential driver using two OPA695 devices driving into an output transformer. The differential driver can be used to either double the available line power or improve distortion by cutting the required output swing in half for each stage. The channel disable required by the MCNS specification must be implemented by using the PGA disable feature. The MCNS disable specification requires that an output impedance match be maintained with the signal channel shut off. The disable feature of the OPA695 is intended principally for power savings and puts the output and inverting input pins into a high-impedance mode, but does not maintain the required output-impedance matching. Turning off the signal at the input of 7-6, while keeping the OPA695 active, maintains the impedance matching while putting very little noise on the line. The line noise in disable for the circuit of 7-6 (with the PGA source turned off, but still presenting a  $75\text{-}\Omega$  source impedance) is a very low  $4\text{ nV}/\sqrt{\text{Hz}}$  ( $-157\text{ dBm}/\text{Hz}$ ) as a result of the low input noise of the OPA695.



图 7-6. Cable Modem Upstream Driver

### 7.1.3.2 Arbitrary Waveform Driver

The OPA695 can be used as the output stage for moderate output power arbitrary waveform driver applications. Driving out through a series 50- $\Omega$  matching resistor into a 50- $\Omega$  matched load allows up to a 4.0- $V_{PP}$  swing at the matched load (15 dBm) when operating the OPA695 on a  $\pm 5$ -V power supply. This level of power is available for gains of either  $\pm 8$  V/V with a flat response through 100 MHz. When interfacing directly from a complementary current output DAC, consider the circuit of 图 7-7, modified for the peak output currents of the particular DAC being considered. Where purely ac-coupled output signals are required from a complementary current output DAC, consider a push-pull output stage using the circuit of 图 7-7. The resistor values here have been calculated for a 20-mA peak output current DAC, which produces up to a 5- $V_{PP}$  swing at the matched load (18 dBm). This approach gives higher power at the load, with lower 2nd-harmonic distortion.

For a 20-mA peak output current DAC, the midscale current of 10 mA gives a 2-V dc output common-mode operating voltage, due to the 200- $\Omega$  resistor to ground at the outputs. The total ac impedance at each output is 50  $\Omega$ , giving a  $\pm 0.5$ -V swing around this 2-V common-mode voltage for the DAC. These resistors also act as a current divider, sending 75% of the DAC output current through the feedback resistor (464  $\Omega$ ). The blocking capacitor references the OPA695 output voltage to ground, and turns the unipolar DAC output current into a bipolar swing of  $0.75 \times 20 \text{ mA} \times 464 \Omega = 7 V_{PP}$  at each amplifier output. Each output is exactly 180° out-of-phase from the other, producing double 7  $V_{PP}$  into the matching resistors. To limit the peak output current and improve distortion, the circuit of 图 7-7 is set up with a 1.4:1 step-down transformer. This reflects the 50- $\Omega$  load to be 100  $\Omega$  at the primary side of the transformer. For the maximum 14- $V_{PP}$  swing across the outputs of the two amplifiers, the matching resistors drop this to 7  $V_{PP}$  at the input of the transformer, then down to 5- $V_{PP}$  maximum at the 50- $\Omega$  load at the output of the transformer. This step-down approach reduces the peak output current to  $14 V_P / (200 \Omega) = 70 \text{ mA}$ .

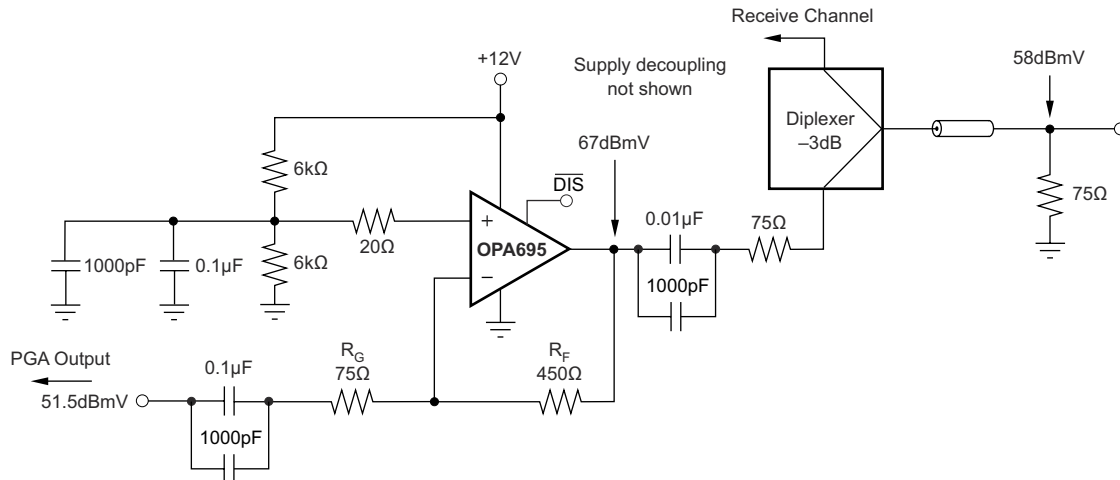

图 7-7. High Power, Wideband AC-Coupled Arbitrary Waveform Driver

### 7.1.4 Differential I/O Applications

The OPA695 offers very low 3rd-order distortion terms with a dominant 2nd-order distortion for the single amplifier operation. For the lowest distortion, particularly where differential outputs are needed, operating two OPA695 devices in a differential I/O design suppresses these even-order terms, delivering extremely low harmonic distortion through high frequencies and powers. Differential outputs are often preferred for high-performance ADCs, twisted-pair driving, and mixer interfaces. Two basic approaches to differential I/Os are the noninverting or inverting configurations. Because the output is differential, the signal polarity is somewhat meaningless; the noninverting and inverting terminology applies here to where the input is brought into the two OPA695s. Each approach has advantages and disadvantages. 图 7-8 shows a basic starting point for noninverting differential I/O applications.

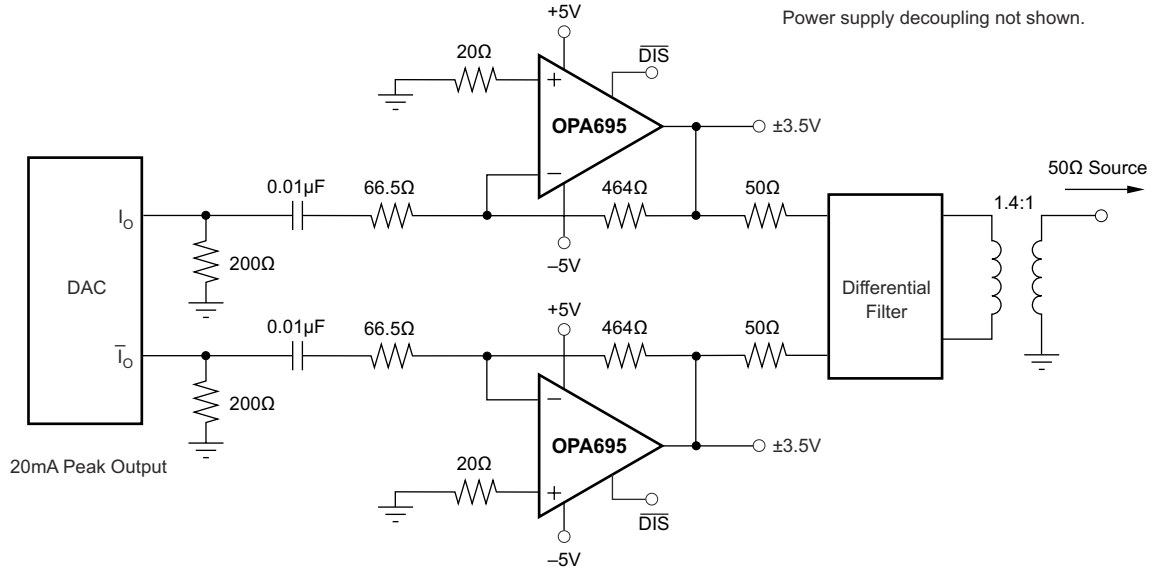

图 7-8. Noninverting Input Differential I/O Amplifier

This approach allows for a source termination impedance independent of the signal gain. For instance, simple differential filters can be included in the signal path directly to the noninverting inputs without interacting with the gain setting. The differential signal gain for the circuit of [Figure 7-8](#) is:

$$A_D = 1 + 2 \times R_F / R_G \quad (5)$$

Because the OPA695 is a current-feedback amplifier, bandwidth is principally controlled with the feedback resistor value: [Figure 7-8](#) shows a typical value of 500  $\Omega$ . However, the differential gain can be adjusted with considerable freedom using just the  $R_G$  resistor.  $R_G$  can be a reactive network providing an isolated shaping to the differential frequency response. AC-coupled applications often include a blocking capacitor in series with  $R_G$ . This blocking capacitor reduces the gain to +1 V/V at low frequency, rising to the  $A_D$  expression shown previously at higher frequencies.

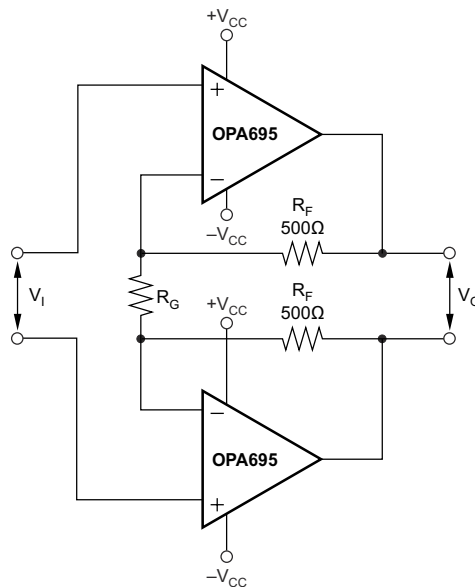
[Figure 7-9](#) shows a differential I/O stage configured as an inverting amplifier. In this case, the gain resistors ( $R_G$ ) become part of the input resistance for the source. This configuration provides a better noise performance than the noninverting configuration, but limits the flexibility in setting the input impedance separately from the gain.

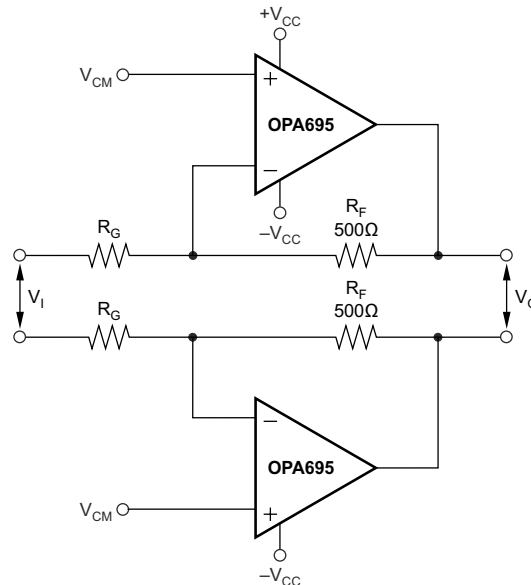

**Figure 7-9. Inverting Input Differential I/O Amplifier**

The two noninverting inputs provide an easy common-mode control input, particularly if the source is ac-coupled through either blocking caps or a transformer. In either case, the common-mode input voltages on the two noninverting inputs again have a gain of +1 V/V to the output pins, giving easy common-mode control for single-supply operation. In this configuration, the OPA695 constrains the feedback to the 500- $\Omega$  region for best frequency response. With  $R_F$  fixed, the input resistors can be adjusted to the desired gain, but also change the input impedance. The high-frequency common-mode gain for this circuit from input to output is the same as for the signal gain. Again, if the source includes an undesired common-mode signal, the signal can be rejected at the input using blocking caps (for low-frequency and dc common-mode) or a transformer coupling. The differential signal gain in the circuit of [Figure 7-9](#) is:

$$A_D = R_F / R_G \quad (6)$$

Using this configuration suppresses the 2nd-harmonics, leaving only 3rd-harmonic terms as the limit to output SFDR. The higher slew rate of the inverting configuration also extends the full-power bandwidth and the range of low intermodulation distortion over the performance bandwidth available from the circuit of [Figure 7-8](#).

## 7.2 Typical Application

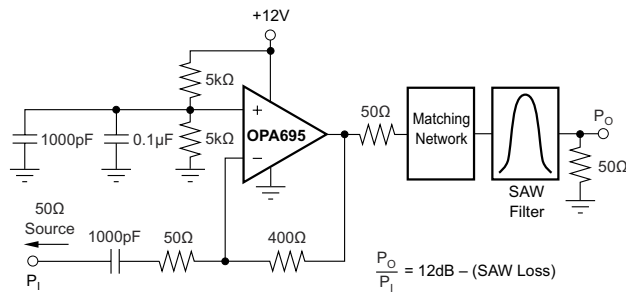

**7-10. IF Amplifier Driving SAW Filter**

## 7.2.1 Design Requirements

### 7.2.1.1 Saw Filter Buffer

One common requirement in an IF strip is to buffer the output of a mixer with enough gain to recover the insertion loss of a narrow-band SAW filter. [Figure 7-10](#) shows one possible configuration driving a SAW filter. [Figure 7-11](#) shows the intercept at the 50- $\Omega$  load. Operating in the inverting mode at a voltage gain of  $-8$  V/V, this circuit provides a 50- $\Omega$  input match using the gain set resistor, has the feedback optimized for maximum bandwidth (700 MHz in this case), and drives through a 50- $\Omega$  output resistor into the matching network at the input of the SAW filter. If the SAW filter gives a 12-dB insertion loss, a net gain of 0 dB to the 50- $\Omega$  load at the output of the SAW (which can be the input impedance of the next IF amplifier or mixer) is delivered in the pass band of the SAW filter. Using the OPA695 in this application isolates the first mixer from the impedance of the SAW filter and provides very low two-tone, 3rd-order spurious levels in the SAW filter bandwidth. Inverting operation gives the broadest bandwidth up to a gain of  $-12$  V/V (15.6 dB). Noninverting operation gives higher bandwidth at gain settings higher than this, but also gives a slight reduction in intercept and noise figure performance.

### 7.2.2 Detailed Design Procedure

The design procedure begins with calculating the required signal gain and signal swing. After the gain and swing requirements are determined the appropriate amplifier is selected along with the required supply voltage. As a result of the input impedance of 50  $\Omega$ , the gain and the input impedance require a feedback resistor value of 400  $\Omega$ .

In this application, the supply voltage is 12 V and single ended. To provide the proper dc operating point, apply a midsupply voltage to the noninverting input by using a resistive voltage divider composed of two 1% precision 5-k $\Omega$  resistors along with two ceramic bypass capacitors. These components provide an accurate and low ac impedance reference voltage for the noninverting input. The inverting input requires only an ac-coupling capacitor to isolate the 6-V operating voltage from the signal source. In this example, a ceramic 1000-pF capacitor is used.

The circuit in [Figure 7-10](#) shows an output resistor value of 50  $\Omega$ . Adjust this resistor to accommodate the SAW input impedance. Additional L/C components can be required as well; consult the SAW manufacturer's design guidelines for more details.

### 7.2.3 Application Curve

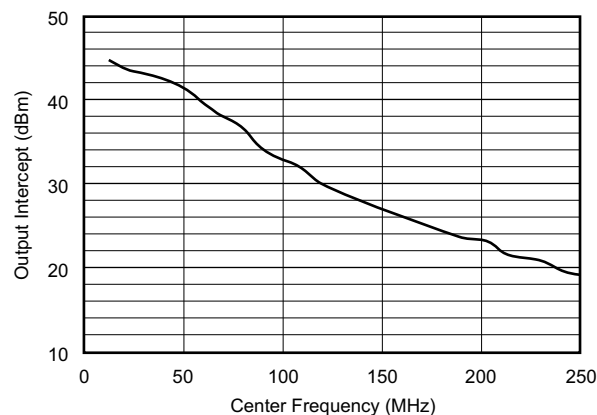

**Figure 7-11. 2-Tone, 3rd-Order Intermodulation Intercept**



## 7.3 Power Supply Recommendations

High-speed amplifiers require low inductance power supply traces and low ESR bypass capacitors. When possible, use both power and ground planes in the printed circuit board design, and the power plane must be adjacent to the ground plane in the board stack-up. Center the power-supply voltage on the desired amplifier output voltage, so for ground-referenced output signals, split supplies are required. Use a power-supply voltage from 5 V to 12 V.

## 7.4 Layout

### 7.4.1 Layout Guidelines

Achieving optimized performance with a high-frequency amplifier like the OPA695 requires careful attention to board layout parasitics and external component types. Recommendations to optimize performance include:

- **Minimize parasitic capacitance to any ac ground for all of the signal I/O pins.** Parasitic capacitance on the output and inverting input pins can cause instability; on the noninverting input, parasitic capacitance can react with the source impedance to cause unintentional band-limiting. To reduce unwanted capacitance, a open a window around the signal I/O pins in all of the ground and power planes around those pins. Otherwise, ground and power planes must be unbroken elsewhere on the board.
- **Minimize the distance (< 0.25") from the power supply pins to high frequency 0.1- $\mu$ F decoupling capacitors.** At the device pins, the ground and power plane layout must not be in close proximity to the signal I/O pins. Avoid narrow power and ground traces to minimize inductance between the pins and the decoupling capacitors. Always decouple the power-supply connections with these capacitors. An optional supply-decoupling capacitor across the two power supplies (for bipolar operation) improves 2nd-harmonic distortion performance. Larger (2.2  $\mu$ F to 6.8  $\mu$ F) decoupling capacitors, effective at a lower frequency, must also be used on the main supply pins. These decoupling capacitors can be placed somewhat farther from the device, and can be shared among several devices in the same area of the PCB.
- **Careful selection and placement of external components preserves the high-frequency performance of the OPA695.** Use low-reactance-type resistors. Surface-mount resistors work best and allow a tighter overall layout. Metal-film and carbon composition, axially-leaded resistors can also provide good high-frequency performance. Keep the leads and PCB trace length as short as possible. Never use wirewound-type resistors in a high frequency application. The output pin and inverting input pin are the most sensitive to parasitic capacitance; therefore, always position the feedback and series output resistor, if any, as close as possible to the output pin. Place other network components, such as noninverting input termination resistors, close to the package. Where double-side component mounting is allowed, place the feedback resistor directly under the package on the other side of the board between the output and inverting input pins. The frequency response is primarily determined by the feedback resistor value. Increasing the value reduces the bandwidth, while decreasing the value gives a more peaked frequency response. The 402- $\Omega$  feedback resistor (used in the typical performance specifications at a gain of +8 on  $\pm$ 5-V supplies) is a good starting point for design. Note that a 523- $\Omega$  feedback resistor, rather than a direct short, is required for the unity gain follower application. A current-feedback operational amplifier requires a feedback resistor, even in the unity gain follower configuration, to control stability.
- **Connections to other wideband devices on the board can be made with short direct traces or through onboard transmission lines.** For short connections, consider the trace and the input to the next device as a lumped capacitive load. Relatively wide traces (50 mils to 100 mils) must be used, preferably with ground and power planes opened up around them. Estimate the total capacitive load and set the series isolation resistance from the isolation resistance versus capacitive load characteristics. If a long trace is required, and the 6-dB signal loss intrinsic to a doubly-terminated transmission line is acceptable, implement a matched impedance transmission line using microstrip or stripline techniques (consult an ECL design handbook for microstrip and stripline layout techniques). A 50- $\Omega$  environment is usually not necessary on board. In fact, a higher impedance environment improves distortion, as shown in the distortion versus load plots. With a characteristic board trace impedance defined (based on board material and trace dimensions), use a matching series resistor into the trace from the output of the OPA695. Also use terminating shunt resistor at the input of the destination device. Remember that the terminating impedance is the parallel combination of the shunt resistor and the input impedance of the destination device; set this total effective impedance to

match the trace impedance. The high output voltage and current capability of the OPA695 allows multiple destination devices to be handled as separate transmission lines, each with series and shunt terminations. If the 6-dB attenuation of a doubly-terminated transmission line is unacceptable, a long trace can be series-terminated at the source end only. Treat the trace as a capacitive load in this case, and set the series isolation resistance from the isolation resistance versus capacitive load characteristics. This setting does not preserve signal integrity as well as a doubly-terminated line. If the input impedance of the destination device is low, some signal attenuation occurs due to the voltage divider formed by the series output into the terminating impedance.

- **Socketing a high-speed part like the OPA695 is not recommended.** The additional lead length and pin-to-pin capacitance introduced by the socket can create a troublesome parasitic network, which makes achieving a smooth, stable frequency response almost impossible. Best results are obtained by soldering the OPA695 directly onto the board.

#### 7.4.2 Layout Example

As detailed in [セクション 7.4.1](#) and illustrated in [図 7-12](#), place the input termination resistor, output resistor, and bypass capacitors close to the amplifier. Power and ground planes can be placed under the amplifier, but must be removed under the input and output pins as shown in [図 7-12](#).



図 7-12. SBOS293 Layout

## 8 Device and Documentation Support

### 8.1 Device Support

#### 8.1.1 Design-In Tools

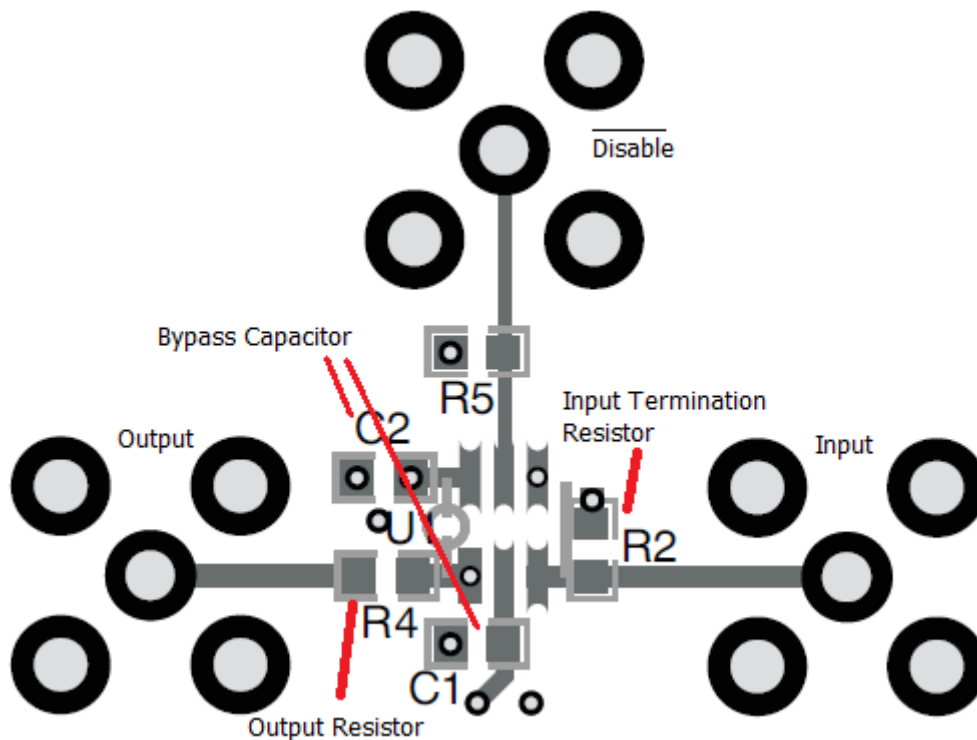
##### 8.1.1.1 Demonstration Fixtures

Two printed circuit boards (PCBs) are available to assist in the initial evaluation of circuit performance using the OPA695 in the two package options. Both of these are offered free of charge as unpopulated PCBs, delivered with a user's guide. 表 8-1 shows the summary information for these fixtures.

表 8-1. Demonstration Boards

PRODUCT	PACKAGE	ORDERING NUMBER	USER'S GUIDE LITERATURE NUMBER
OPA695ID	VSSOP-8	DEM-OPA-SO-1B	<a href="#">SBOU026</a>
OPA691IDBV	SOT23-6	DEM-OPA-SOT-1B	<a href="#">SBOU027</a>

The demonstration fixtures can be requested at the Texas Instruments web site ([www.ti.com](http://www.ti.com)) through the [OPA695 product folder](#).

### 8.2 Documentation Support

#### 8.2.1 Related Documentation

For related documentation, see the following:

- Texas Instruments, [Absolute Maximum Ratings for Soldering](#)
- Texas Instruments, [Current Feedback Op Amp Applications Circuit Guide, Application Note OA--07](#)
- Texas Instruments, [Frequent Faux Pas in Applying Wideband Current Feedback Amplifiers, Application Note OA-15](#)
- Texas Instruments, [Noise Analysis for Comlinear Amplifiers, Application Note OA-12](#)
- Texas Instruments, [Semiconductor and IC Package Thermal Metrics](#)

### 8.3 ドキュメントの更新通知を受け取る方法

ドキュメントの更新についての通知を受け取るには、[www.tij.co.jp](http://www.tij.co.jp) のデバイス製品フォルダを開いてください。[通知] をクリックして登録すると、変更されたすべての製品情報に関するダイジェストを毎週受け取ることができます。変更の詳細については、改訂されたドキュメントに含まれている改訂履歴をご覧ください。

### 8.4 サポート・リソース

テキサス・インスツルメンツ E2E™ サポート・フォーラムは、エンジニアが検証済みの回答と設計に関するヒントをエキスパートから迅速かつ直接得ることができる場所です。既存の回答を検索したり、独自の質問をしたりすることで、設計に必要な支援を迅速に得ることができます。

リンクされているコンテンツは、各寄稿者により「現状のまま」提供されるものです。これらはテキサス・インスツルメンツの仕様を構成するものではなく、必ずしもテキサス・インスツルメンツの見解を反映したものではありません。テキサス・インスツルメンツの[使用条件](#)を参照してください。

### 8.5 Trademarks

テキサス・インスツルメンツ E2E™ is a trademark of Texas Instruments.

すべての商標は、それぞれの所有者に帰属します。

### 8.6 静電気放電に関する注意事項



この IC は、ESD によって破損する可能性があります。テキサス・インスツルメンツは、IC を取り扱う際には常に適切な注意を払うことを推奨します。正しい取り扱いおよび設置手順に従わない場合、デバイスを破損するおそれがあります。

ESD による破損は、わずかな性能低下からデバイスの完全な故障まで多岐にわたります。精密な IC の場合、パラメータがわずかに変化するだけで公表されている仕様から外れる可能性があるため、破損が発生しやすくなっています。

## 8.7 用語集

テキサス・インスツルメンツ用語集

この用語集には、用語や略語の一覧および定義が記載されています。

## 9 Revision History

資料番号末尾の英字は改訂を表しています。その改訂履歴は英語版に準じています。

Changes from Revision H (April 2015) to Revision I (October 2024)	Page
ドキュメント全体にわたって表、図、相互参照の採番方法を更新.....	1
Changed the supply voltage specification from $\pm 6.5$ V to 13 V in <i>Absolute Maximum Ratings</i> .....	4
Updated the footnote in <i>Absolute Maximum Ratings</i> to add clarification .....	4
Added continuous input current specification to <i>Absolute Maximum Ratings</i> .....	4
Deleted machine model (MM) specification from <i>ESD Ratings</i> .....	4
Updated thermal specifications for D and DBV package in <i>Thermal Information</i> .....	4
Deleted $T_A = 0^\circ\text{C}$ to $+70^\circ\text{C}$ specifications from across all <i>Electrical Characteristics Table</i> .....	5
Deleted the minimum, maximum, and over temperature specifications in the <i>Electrical Characteristics: AC Performance</i> sections.....	5
Changed SSBW at $G = +1$ V/V from 1700 MHz to 1900 MHz in <i>Electrical Characteristics: <math>V_S = \pm 5</math> V, OPA695D, OPA695DBV Table</i> .....	5
Changed SSBW at $G = +2$ V/V from 1400 MHz to 900 MHz in <i>Electrical Characteristics: <math>V_S = \pm 5</math> V, OPA695D, OPA695DBV Table</i> .....	5
Changed typical SSBW at $G = +8$ V/V from 450 MHz to 600 MHz in <i>Electrical Characteristics: <math>V_S = \pm 5</math> V, OPA695D, OPA695DBV Table</i> .....	5
Changed SSBW at $G = +16$ V/V from 350 MHz to 500 MHz in <i>Electrical Characteristics: <math>V_S = \pm 5</math> V, OPA695D, OPA695DBV Table</i> .....	5
Changed Bandwidth for 0.2-dB gain flatness from 320 MHz to 120 MHz in <i>Electrical Characteristics: <math>V_S = \pm 5</math> V, OPA695D, OPA695DBV Table</i> .....	5
Changed typical Peaking at a gain of +1V/V from 4.6 dB to 3.7 dB in <i>Electrical Characteristics: <math>V_S = \pm 5</math> V, OPA695D, OPA695DBV Table</i> .....	5
Changed LSBW at $G = 8$ V/V from 450 MHz to 510 MHz in <i>Electrical Characteristics: <math>V_S = \pm 5</math> V, OPA695D, OPA695DBV Table</i> .....	5
Changed typical Slew rate at $G = -8$ V/V from 4300 V/ $\mu\text{s}$ to 5000 V/ $\mu\text{s}$ in <i>Electrical Characteristics: <math>V_S = \pm 5</math> V, OPA695D, OPA695DBV Table</i> .....	5
Changed typical Slew rate at $G = +8$ V/V from 4300 V/ $\mu\text{s}$ to 5000 V/ $\mu\text{s}$ in <i>Electrical Characteristics: <math>V_S = \pm 5</math> V, OPA695D, OPA695DBV Table</i> .....	5
Changed Rise and fall time at $V_O = 0.5$ -V Step from 0.8 ns to 0.65 ns in <i>Electrical Characteristics: <math>V_S = \pm 5</math> V, OPA695D, OPA695DBV Table</i> .....	5
Changed Rise and fall time at $V_O = 4$ -V Step from 1 ns to 0.7 ns in <i>Electrical Characteristics: <math>V_S = \pm 5</math> V, OPA695D, OPA695DBV Table</i> .....	5
Changed Settling time to 0.5% of 10 ns from Settling time to 0.1% of 10 ns in <i>Electrical Characteristics: <math>V_S = \pm 5</math> V, OPA695D, OPA695DBV Table</i> .....	5
Deleted settling time to 0.02% and 0.1% from <i>Electrical Characteristics Table</i> .....	5
Changed typical 2nd-order Harmonic Distortion at $R_L = 100 \Omega$ from $-65$ dBc to $-75$ dBc in <i>Electrical Characteristics: <math>V_S = \pm 5</math> V, OPA695D, OPA695DBV Table</i> .....	5
Changed typical 3rd-order Harmonic Distortion at $R_L = 100 \Omega$ from $-86$ dBc to $-92$ dBc in <i>Electrical Characteristics: <math>V_S = \pm 5</math> V, OPA695D, OPA695DBV Table</i> .....	5
Changed typical Input voltage noise from 1.8 nV/ $\sqrt{\text{Hz}}$ to 2 nV/ $\sqrt{\text{Hz}}$ in <i>Electrical Characteristics: <math>V_S = \pm 5</math> V, OPA695D, OPA695DBV Table</i> .....	5
Changed typical noninverting input current noise from 18 pA/ $\sqrt{\text{Hz}}$ to 14 pA/ $\sqrt{\text{Hz}}$ in <i>Electrical Characteristics: <math>V_S = \pm 5</math> V, OPA695D, OPA695DBV Table</i> .....	5
Deleted differential gain and differential phase specifications from across all <i>Electrical Characteristics</i> .....	5
Changed typical Open-loop transimpedance gain from 85 k $\Omega$ to 300 k $\Omega$ in <i>Electrical Characteristics: <math>V_S = \pm 5</math> V, OPA695D, OPA695DBV Table</i> .....	5

• Changed typical Inverting input bias current from $\pm 20 \mu\text{A}$ to $\pm 5 \mu\text{A}$ in <i>Electrical Characteristics: <math>V_S = \pm 5 \text{ V}</math>, OPA695D, OPA695DBV Table</i> .....	5
• Added typical specification for Average inverting input bias current drift in <i>Electrical Characteristics: <math>V_S = \pm 5 \text{ V}</math>, OPA695D, OPA695DBV Table</i> .....	5
• Changed typical Common-mode input range from $\pm 3.3 \text{ V}$ to $\pm 3.4 \text{ V}$ in <i>Electrical Characteristics: <math>V_S = \pm 5 \text{ V}</math>, OPA695D, OPA695DBV Table</i> .....	5
• Changed typical Common-mode rejection ratio from 56 dB to 65 dB in <i>Electrical Characteristics: <math>V_S = \pm 5 \text{ V}</math>, OPA695D, OPA695DBV Table</i> .....	5
• Changed Noninverting input impedance from $280 \parallel 1.2 \text{ (k}\Omega \parallel \text{pF)}$ to $450 \parallel 2 \text{ (k}\Omega \parallel \text{pF)}$ in <i>Electrical Characteristics: <math>V_S = \pm 5 \text{ V}</math>, OPA695D, OPA695DBV Table</i> .....	5
• Changed Inverting input resistance from $29 \Omega$ to $20 \Omega$ in <i>Electrical Characteristics: <math>V_S = \pm 5 \text{ V}</math>, OPA695D, OPA695DBV Table</i> .....	5
• Changed minimum Output voltage swing at no load from $\pm 4 \text{ V}$ to $\pm 3.95 \text{ V}$ in <i>Electrical Characteristics: <math>V_S = \pm 5 \text{ V}</math>, OPA695D, OPA695DBV Table</i> .....	5
• Changed typical Output voltage swing at no load from $\pm 4.2 \text{ V}$ to $\pm 4.05 \text{ V}$ in <i>Electrical Characteristics: <math>V_S = \pm 5 \text{ V}</math>, OPA695D, OPA695DBV Table</i> .....	5
• Changed minimum Output voltage swing at no load, $T_A = -40^\circ\text{C}$ to $+85^\circ\text{C}$ from $\pm 3.9 \text{ V}$ to $\pm 3.85 \text{ V}$ in <i>Electrical Characteristics: <math>V_S = \pm 5 \text{ V}</math>, OPA695D, OPA695DBV Table</i> .....	5
• Changed minimum Output voltage swing at $R_L = 100 \Omega$ from $\pm 3.7 \text{ V}$ to $\pm 3.65 \text{ V}$ in <i>Electrical Characteristics: <math>V_S = \pm 5 \text{ V}</math>, OPA695D, OPA695DBV Table</i> .....	5
• Changed typical Output voltage swing at $R_L = 100 \Omega$ from $\pm 3.9 \text{ V}$ to $\pm 3.75 \text{ V}$ in <i>Electrical Characteristics: <math>V_S = \pm 5 \text{ V}</math>, OPA695D, OPA695DBV Table</i> .....	5
• Changed minimum Output voltage swing at $R_L = 100 \Omega$ , $T_A = -40^\circ\text{C}$ to $+85^\circ\text{C}$ from $\pm 3.6 \text{ V}$ to $\pm 3.55 \text{ V}$ in <i>Electrical Characteristics: <math>V_S = \pm 5 \text{ V}</math>, OPA695D, OPA695DBV Table</i> .....	5
• Changed typical Output current sourcing from 120 mA to 140 mA in <i>Electrical Characteristics: <math>V_S = \pm 5 \text{ V}</math>, OPA695D, OPA695DBV Table</i> .....	5
• Changed typical Output current sourcing from $-120 \text{ mA}$ to $-140 \text{ mA}$ in <i>Electrical Characteristics: <math>V_S = \pm 5 \text{ V}</math>, OPA695D, OPA695DBV Table</i> .....	5
• Changed Closed-Loop output impedance from $0.04 \Omega$ to $0.02 \Omega$ in <i>Electrical Characteristics: <math>V_S = \pm 5 \text{ V}</math>, OPA695D, OPA695DBV Table</i> .....	5
• Changed typical Quiescent current from 12.9 mA to 14 mA in <i>Electrical Characteristics: <math>V_S = \pm 5 \text{ V}</math>, OPA695D, OPA695DBV Table</i> .....	5
• Changed minimum and maximum Quiescent current from 12.6 mA and 13.3 mA to 11.7 mA and 15.6 mA in <i>Electrical Characteristics: <math>V_S = \pm 5 \text{ V}</math>, OPA695D, OPA695DBV Table</i> .....	5
• Changed minimum and maximum Quiescent current, $T_A = -40^\circ\text{C}$ to $+85^\circ\text{C}$ from 11 mA and 14.1 mA to 10 mA and 18 mA in <i>Electrical Characteristics: <math>V_S = \pm 5 \text{ V}</math>, OPA695D, OPA695DBV Table</i> .....	5
• Changed typical negative power-supply rejection ratio from 55 dB to 72 dB in <i>Electrical Characteristics: <math>V_S = \pm 5 \text{ V}</math>, OPA695D, OPA695DBV Table</i> .....	5
• Changed minimum Power-down quiescent current from $-170 \mu\text{A}$ to $200 \mu\text{A}$ in <i>Electrical Characteristics: <math>V_S = \pm 5 \text{ V}</math>, OPA695D, OPA695DBV Table</i> .....	5
• Changed typical Power-down quiescent current from $-100 \mu\text{A}$ to $160 \mu\text{A}$ in <i>Electrical Characteristics: <math>V_S = \pm 5 \text{ V}</math>, OPA695D, OPA695DBV Table</i> .....	5
• Changed minimum Power-down quiescent current, $T_A = -40^\circ\text{C}$ to $+85^\circ\text{C}$ from $-192 \mu\text{A}$ to $210 \mu\text{A}$ in <i>Electrical Characteristics: <math>V_S = \pm 5 \text{ V}</math>, OPA695D, OPA695DBV Table</i> .....	5
• Changed Disable time from $1 \mu\text{s}$ to $4 \mu\text{s}$ in <i>Electrical Characteristics: <math>V_S = \pm 5 \text{ V}</math>, OPA695D, OPA695DBV Table</i> .....	5
• Changed Enable time from 25 ns to 80 ns in <i>Electrical Characteristics: <math>V_S = \pm 5 \text{ V}</math>, OPA695D, OPA695DBV Table</i> .....	5
• Changed Output capacitance in disable from 4 pF to 2.5 pF in <i>Electrical Characteristics: <math>V_S = \pm 5 \text{ V}</math>, OPA695D, OPA695DBV Table</i> .....	5
• Changed typical Enable voltage threshold from 3.3 V to 3 V in <i>Electrical Characteristics: <math>V_S = \pm 5 \text{ V}</math>, OPA695D, OPA695DBV Table</i> .....	5

• Changed typical Disable voltage threshold from 1.8 V to 2.3 V in <i>Electrical Characteristics: <math>V_S = \pm 5 V</math>, OPA695D, OPA695DBV Table</i> .....	5
• Changed typical Disable Control pin input bias current from 75 $\mu A$ to 95 $\mu A$ in <i>Electrical Characteristics: <math>V_S = \pm 5 V</math>, OPA695D, OPA695DBV Table</i> .....	5
• Updated test level related and current polarity footnote across the <i>Electrical Characteristics</i> .....	5
• Changed SSBW at $G = 1 V/V$ from 1400 MHz to 1200 MHz in <i>Electrical Characteristics: <math>V_S = 5 V</math>, OPA695D, OPA695DBV</i> .....	7
• Changed SSBW at $G = 2 V/V$ from 960 MHz to 700 MHz in <i>Electrical Characteristics: <math>V_S = 5 V</math>, OPA695D, OPA695DBV</i> .....	7
• Changed typical SSBW at $G = 8 V/V$ from 395 MHz to 500 MHz in <i>Electrical Characteristics: <math>V_S = 5 V</math>, OPA695D, OPA695DBV</i> .....	7
• Changed typical SSBW at $G = 16 V/V$ from 235 MHz to 410 MHz in <i>Electrical Characteristics: <math>V_S = 5 V</math>, OPA695D, OPA695DBV</i> .....	7
• Changed Bandwidth for 0.2-dB gain flatness from 230 MHz to 110 MHz in <i>Electrical Characteristics: <math>V_S = 5 V</math>, OPA695D, OPA695DBV</i> .....	7
• Changed typical Peaking at a gain of $+1V/V$ from 1 dB to 2.2 dB in <i>Electrical Characteristics: <math>V_S = 5 V</math>, OPA695D, OPA695DBV</i> .....	7
• Changed LSBW at $G = 8 V/V$ from 310 MHz to 430 MHz in <i>Electrical Characteristics: <math>V_S = 5 V</math>, OPA695D, OPA695DBV</i> .....	7
• Changed typical Slew rate at $G = +8 V/V$ from 1700 V/ $\mu s$ to 2500 V/ $\mu s$ in <i>Electrical Characteristics: <math>V_S = 5 V</math>, OPA695D, OPA695DBV</i> .....	7
• Changed Rise and fall time at $V_O = 0.5\text{-V}$ step from 1 ns to 0.7 ns in <i>Electrical Characteristics: <math>V_S = 5 V</math>, OPA695D, OPA695DBV</i> .....	7
• Changed Rise and fall time at $V_O = 2\text{-V}$ step from 1 ns to 0.8 ns in <i>Electrical Characteristics: <math>V_S = 5 V</math>, OPA695D, OPA695DBV</i> .....	7
• Changed Settling time to 0.5% of 10 ns from Settling time to 0.1% of 10 ns in <i>Electrical Characteristics: <math>V_S = 5 V</math>, OPA695D, OPA695DBV</i> .....	7
• Changed typical 2nd-order harmonic distortion at $R_L = 100 \Omega$ to $-69$ dBc from $-62$ dBc in <i>Electrical Characteristics: <math>V_S = 5 V</math>, OPA695D, OPA695DBV</i> .....	7
• Changed typical 2nd-order harmonic distortion at $R_L = 500 \Omega$ to $-68$ dBc from $-70$ dBc in <i>Electrical Characteristics: <math>V_S = 5 V</math>, OPA695D, OPA695DBV</i> .....	7
• Changed typical 3rd-order harmonic distortion at $R_L = 100 \Omega$ to $-62$ dBc from $-66$ dBc in <i>Electrical Characteristics: <math>V_S = 5 V</math>, OPA695D, OPA695DBV</i> .....	7
• Changed typical 3rd-order harmonic distortion at $R_L = 500 \Omega$ to $-63$ dBc from $-65$ dBc in <i>Electrical Characteristics: <math>V_S = 5 V</math>, OPA695D, OPA695DBV</i> .....	7
• Changed typical Input voltage noise from 1.8 nV/ $\sqrt{Hz}$ to 1.9 nV/ $\sqrt{Hz}$ in <i>Electrical Characteristics: <math>V_S = 5 V</math>, OPA695D, OPA695DBV</i> .....	7
• Changed typical Noninverting input current noise from 18 pA/ $\sqrt{Hz}$ to 14 pA/ $\sqrt{Hz}$ in <i>Electrical Characteristics: <math>V_S = 5 V</math>, OPA695D, OPA695DBV</i> .....	7
• Changed typical Open-loop transimpedance gain from 70 k $\Omega$ to 250 k $\Omega$ in <i>Electrical Characteristics: <math>V_S = 5 V</math>, OPA695D, OPA695DBV</i> .....	7
• Changed typical Noninverting input bias current from $\pm 5 \mu A$ to $+15 \mu A$ in <i>Electrical Characteristics: <math>V_S = 5 V</math>, OPA695D, OPA695DBV</i> .....	7
• Changed typical Common-mode input range (positive) from 3.3 V to 3.4 V in <i>Electrical Characteristics: <math>V_S = 5 V</math>, OPA695D, OPA695DBV</i> .....	7
• Changed typical Common-mode input range (negative) from 1.7 V to 1.6 V in <i>Electrical Characteristics: <math>V_S = 5 V</math>, OPA695D, OPA695DBV</i> .....	7
• Changed typical Common-mode rejection ratio from 54 dB to 65 dB in <i>Electrical Characteristics: <math>V_S = 5 V</math>, OPA695D, OPA695DBV</i> .....	7
• Changed Noninverting input impedance from 280 $\parallel$ 1.2 (k $\Omega$ $\parallel$ pF) to 250 $\parallel$ 2 (k $\Omega$ $\parallel$ pF) in <i>Electrical Characteristics: <math>V_S = 5 V</math>, OPA695D, OPA695DBV</i> .....	7
• Changed Inverting input resistance from 32 $\Omega$ to 21 $\Omega$ in <i>Electrical Characteristics: <math>V_S = 5 V</math>, OPA695D, OPA695DBV</i> .....	7

- Changed typical Output voltage (positive) at no load from 4.2 V to 4.05 V in *Electrical Characteristics:  $V_S = 5$  V, OPA695D, OPA695DBV* ..... 7
- Changed minimum Output voltage swing (positive) at no load from 4 V to 3.95 V in *Electrical Characteristics:  $V_S = 5$  V, OPA695D, OPA695DBV* ..... 7
- Changed minimum Output voltage swing (positive) at no load,  $T_A = -40^\circ\text{C}$  to  $+85^\circ\text{C}$  from 3.8 V to 3.75 V in *Electrical Characteristics:  $V_S = 5$  V, OPA695D, OPA695DBV* ..... 7
- Changed maximum Output voltage swing (negative) at no load from 1 V to 1.05 V in *Electrical Characteristics:  $V_S = 5$  V, OPA695D, OPA695DBV* ..... 7
- Changed typical Output voltage swing (negative) at no load from 0.8 V to 0.9 V in *Electrical Characteristics:  $V_S = 5$  V, OPA695D, OPA695DBV* ..... 7
- Changed maximum Output voltage swing (negative) at no load,  $T_A = -40^\circ\text{C}$  to  $+85^\circ\text{C}$  from 1.2 V to 1.25 V in *Electrical Characteristics:  $V_S = 5$  V, OPA695D, OPA695DBV* ..... 7
- Changed typical Output current sourcing from 90 mA to 100 mA in *Electrical Characteristics:  $V_S = 5$  V, OPA695D, OPA695DBV* ..... 7
- Changed minimum Output current sinking,  $T_A = -40^\circ\text{C}$  to  $+85^\circ\text{C}$  from -66 mA to -60 mA in *Electrical Characteristics:  $V_S = 5$  V, OPA695D, OPA695DBV* ..... 7
- Changed Closed-loop output impedance from 0.05  $\Omega$  to 0.02  $\Omega$  in *Electrical Characteristics:  $V_S = 5$  V, OPA695D, OPA695DBV* ..... 7
- Changed maximum Quiescent current from 12 mA to 14.4 mA in *Electrical Characteristics:  $V_S = 5$  V, OPA695D, OPA695DBV* ..... 7
- Changed maximum Quiescent current,  $T_A = -40^\circ\text{C}$  to  $+85^\circ\text{C}$  from 12.9 mA to 17.1 mA in *Electrical Characteristics:  $V_S = 5$  V, OPA695D, OPA695DBV* ..... 7
- Changed typical Negative power-supply rejection ratio from 51 dB to 69 dB in *Electrical Characteristics:  $V_S = 5$  V, OPA695D, OPA695DBV Table*..... 7
- Changed typical Power-down quiescent current from -95  $\mu\text{A}$  to 120  $\mu\text{A}$  in *Electrical Characteristics:  $V_S = 5$  V, OPA695D, OPA695DBV Table*..... 7
- Changed Disable time from 1  $\mu\text{s}$  to 5  $\mu\text{s}$  in *Electrical Characteristics:  $V_S = 5$  V, OPA695D, OPA695DBV* ..... 7
- Changed Enable time from 25 ns to 80 ns in *Electrical Characteristics:  $V_S = 5$  V, OPA695D, OPA695DBV* .... 7
- Changed typical Enable voltage threshold from 3.3 V to 3.1 V in *Electrical Characteristics:  $V_S = 5$  V, OPA695D, OPA695DBV* ..... 7
- Changed typical Disable voltage threshold from 1.8 V to 2.4 V in *Electrical Characteristics:  $V_S = 5$  V, OPA695D, OPA695DBV* ..... 7
- Changed typical Disable Control pin input bias current from 75  $\mu\text{A}$  to 95  $\mu\text{A}$  in *Electrical Characteristics:  $V_S = 5$  V, OPA695D, OPA695DBV Table*..... 7
- Deleted Composite Video dG/d $\phi$  plot from *Typical Characteristics:  $V_S = \pm 5$  V, OPA695IDGK* ..... 20
- Deleted the differential operation plots from *Typical Characteristics:  $V_S = \pm 5$  V, OPA695IDGK* and differential small signal parameter measurement information section..... 20
- Deleted *RF Specifications and Applications, Input Return Loss (S11), Output Return Loss (S22), Forward Gain (S21), Reverse Isolation and Limits to Dynamic Range* from *Feature Description* ..... 27
- Deleted *SAW Filter Buffer and RGB Video Line Driver* sections from *Application Information* ..... 30

**Changes from Revision G (April 2009) to Revision H (April 2015) Page**

- 「ESD 定格」表、「機能説明」セクション、「デバイスの機能モード」セクション、「アプリケーションと実装」セクション、「電源に関する推奨事項」セクション、「レイアウト」セクション、「デバイスおよびドキュメントのサポート」セクション、「メカニカル、パッケージ、および注文情報」セクションを追加 ..... 1

**Changes from Revision F (July 2006) to Revision G (April 2009) Page**

- 「パッケージ注文情報」表および「電気的特性」表の熱抵抗仕様に DGK (MSOP-8) パッケージを追加 ..... 1

---

**Changes from Revision E (March 2006) to Revision F (July 2006)**

**Page**

- Changed Storage Temperature Range from  $-40^{\circ}\text{C}$  to  $+125^{\circ}\text{C}$  to  $-65^{\circ}\text{C}$  to  $+125^{\circ}\text{C}$ .....4
- 

**10 Mechanical, Packaging, and Orderable Information**

The following pages include mechanical, packaging, and orderable information. This information is the most current data available for the designated devices. This data is subject to change without notice and revision of this document. For browser-based versions of this data sheet, refer to the left-hand navigation.



## 重要なお知らせと免責事項

テキサス・インスツルメンツは、技術データと信頼性データ (データシートを含みます)、設計リソース (リファレンス デザインを含みます)、アプリケーションや設計に関する各種アドバイス、Web ツール、安全性情報、その他のリソースを、欠陥が存在する可能性のある「現状のまま」提供しており、商品性および特定目的に対する適合性の黙示保証、第三者の知的財産権の非侵害保証を含むいかなる保証も、明示的または黙示的にかかわらず拒否します。

これらのリソースは、テキサス・インスツルメンツ製品を使用する設計の経験を積んだ開発者への提供を意図したものです。(1) お客様のアプリケーションに適した テキサス・インスツルメンツ製品の選定、(2) お客様のアプリケーションの設計、検証、試験、(3) お客様のアプリケーションに該当する各種規格や、その他のあらゆる安全性、セキュリティ、規制、または他の要件への確実な適合に関する責任を、お客様のみが単独で負うものとします。

上記の各種リソースは、予告なく変更される可能性があります。これらのリソースは、リソースで説明されている テキサス・インスツルメンツ製品を使用するアプリケーションの開発の目的でのみ、テキサス・インスツルメンツはその使用をお客様に許諾します。これらのリソースに関して、他の目的で複製することや掲載することは禁止されています。テキサス・インスツルメンツや第三者の知的財産権のライセンスが付与されている訳ではありません。お客様は、これらのリソースを自身で使用した結果発生するあらゆる申し立て、損害、費用、損失、責任について、テキサス・インスツルメンツおよびその代理人を完全に補償するものとし、テキサス・インスツルメンツは一切の責任を拒否します。

テキサス・インスツルメンツの製品は、[テキサス・インスツルメンツの販売条件](#)、または [ti.com](https://www.ti.com) やかかる テキサス・インスツルメンツ製品の関連資料などのいずれかを通じて提供する適用可能な条項の下で提供されています。テキサス・インスツルメンツがこれらのリソースを提供することは、適用されるテキサス・インスツルメンツの保証または他の保証の放棄の拡大や変更を意味するものではありません。

お客様がいかなる追加条項または代替条項を提案した場合でも、テキサス・インスツルメンツはそれらに異議を唱え、拒否します。

郵送先住所: Texas Instruments, Post Office Box 655303, Dallas, Texas 75265

Copyright © 2024, Texas Instruments Incorporated

**PACKAGING INFORMATION**

Orderable Device	Status (1)	Package Type	Package Drawing	Pins	Package Qty	Eco Plan (2)	Lead finish/ Ball material (6)	MSL Peak Temp (3)	Op Temp (°C)	Device Marking (4/5)	Samples
OPA695ID	OBSOLETE	SOIC	D	8		TBD	Call TI	Call TI	-40 to 85	OPA 695	
OPA695IDBVR	ACTIVE	SOT-23	DBV	6	3000	RoHS & Green	SN	Level-1-260C-UNLIM	-40 to 85	A71L	Samples
OPA695IDBVT	OBSOLETE	SOT-23	DBV	6		TBD	Call TI	Call TI	-40 to 85	A71L	
OPA695IDGKR	ACTIVE	VSSOP	DGK	8	2500	RoHS & Green	NIPDAUAG	Level-2-260C-1 YEAR	-40 to 85	695	Samples
OPA695IDGKT	ACTIVE	VSSOP	DGK	8	250	RoHS & Green	NIPDAUAG	Level-2-260C-1 YEAR	-40 to 85	695	Samples
OPA695IDR	ACTIVE	SOIC	D	8	2500	RoHS & Green	NIPDAU	Level-2-260C-1 YEAR	-40 to 85	OPA 695	Samples

(1) The marketing status values are defined as follows:

**ACTIVE:** Product device recommended for new designs.

**LIFEBUY:** TI has announced that the device will be discontinued, and a lifetime-buy period is in effect.

**NRND:** Not recommended for new designs. Device is in production to support existing customers, but TI does not recommend using this part in a new design.

**PREVIEW:** Device has been announced but is not in production. Samples may or may not be available.

**OBSOLETE:** TI has discontinued the production of the device.

(2) **RoHS:** TI defines "RoHS" to mean semiconductor products that are compliant with the current EU RoHS requirements for all 10 RoHS substances, including the requirement that RoHS substance do not exceed 0.1% by weight in homogeneous materials. Where designed to be soldered at high temperatures, "RoHS" products are suitable for use in specified lead-free processes. TI may reference these types of products as "Pb-Free".

**RoHS Exempt:** TI defines "RoHS Exempt" to mean products that contain lead but are compliant with EU RoHS pursuant to a specific EU RoHS exemption.

**Green:** TI defines "Green" to mean the content of Chlorine (Cl) and Bromine (Br) based flame retardants meet JS709B low halogen requirements of <=1000ppm threshold. Antimony trioxide based flame retardants must also meet the <=1000ppm threshold requirement.

(3) MSL, Peak Temp. - The Moisture Sensitivity Level rating according to the JEDEC industry standard classifications, and peak solder temperature.

(4) There may be additional marking, which relates to the logo, the lot trace code information, or the environmental category on the device.

(5) Multiple Device Markings will be inside parentheses. Only one Device Marking contained in parentheses and separated by a "~" will appear on a device. If a line is indented then it is a continuation of the previous line and the two combined represent the entire Device Marking for that device.

(6) Lead finish/Ball material - Orderable Devices may have multiple material finish options. Finish options are separated by a vertical ruled line. Lead finish/Ball material values may wrap to two lines if the finish value exceeds the maximum column width.

**Important Information and Disclaimer:** The information provided on this page represents TI's knowledge and belief as of the date that it is provided. TI bases its knowledge and belief on information provided by third parties, and makes no representation or warranty as to the accuracy of such information. Efforts are underway to better integrate information from third parties. TI has taken and continues to take reasonable steps to provide representative and accurate information but may not have conducted destructive testing or chemical analysis on incoming materials and chemicals. TI and TI suppliers consider certain information to be proprietary, and thus CAS numbers and other limited information may not be available for release.

In no event shall TI's liability arising out of such information exceed the total purchase price of the TI part(s) at issue in this document sold by TI to Customer on an annual basis.

**TAPE AND REEL INFORMATION**

**QUADRANT ASSIGNMENTS FOR PIN 1 ORIENTATION IN TAPE**

\*All dimensions are nominal

Device	Package Type	Package Drawing	Pins	SPQ	Reel Diameter (mm)	Reel Width W1 (mm)	A0 (mm)	B0 (mm)	K0 (mm)	P1 (mm)	W (mm)	Pin1 Quadrant
OPA695IDBVR	SOT-23	DBV	6	3000	180.0	8.4	3.2	3.2	1.4	4.0	8.0	Q3
OPA695IDGKR	VSSOP	DGK	8	2500	330.0	12.4	5.3	3.4	1.4	8.0	12.0	Q1
OPA695IDGKT	VSSOP	DGK	8	250	180.0	12.4	5.3	3.4	1.4	8.0	12.0	Q1
OPA695IDR	SOIC	D	8	2500	330.0	12.4	6.4	5.2	2.1	8.0	12.0	Q1
OPA695IDR	SOIC	D	8	2500	330.0	12.4	6.4	5.2	2.1	8.0	12.0	Q1

## TAPE AND REEL BOX DIMENSIONS



\*All dimensions are nominal

Device	Package Type	Package Drawing	Pins	SPQ	Length (mm)	Width (mm)	Height (mm)
OPA695IDBVR	SOT-23	DBV	6	3000	210.0	185.0	35.0
OPA695IDGKR	VSSOP	DGK	8	2500	356.0	356.0	35.0
OPA695IDGKT	VSSOP	DGK	8	250	210.0	185.0	35.0
OPA695IDR	SOIC	D	8	2500	353.0	353.0	32.0
OPA695IDR	SOIC	D	8	2500	356.0	356.0	35.0



D0008A

# PACKAGE OUTLINE

SOIC - 1.75 mm max height

SMALL OUTLINE INTEGRATED CIRCUIT



4214825/C 02/2019

NOTES:

- Linear dimensions are in inches [millimeters]. Dimensions in parenthesis are for reference only. Controlling dimensions are in inches. Dimensioning and tolerancing per ASME Y14.5M.
- This drawing is subject to change without notice.
- This dimension does not include mold flash, protrusions, or gate burrs. Mold flash, protrusions, or gate burrs shall not exceed .006 [0.15] per side.
- This dimension does not include interlead flash.
- Reference JEDEC registration MS-012, variation AA.

# EXAMPLE BOARD LAYOUT

D0008A

SOIC - 1.75 mm max height

SMALL OUTLINE INTEGRATED CIRCUIT



LAND PATTERN EXAMPLE  
 EXPOSED METAL SHOWN  
 SCALE:8X



SOLDER MASK DETAILS

4214825/C 02/2019

NOTES: (continued)

- 6. Publication IPC-7351 may have alternate designs.
- 7. Solder mask tolerances between and around signal pads can vary based on board fabrication site.

# EXAMPLE STENCIL DESIGN

D0008A

SOIC - 1.75 mm max height

SMALL OUTLINE INTEGRATED CIRCUIT



SOLDER PASTE EXAMPLE  
BASED ON .005 INCH [0.125 MM] THICK STENCIL  
SCALE:8X

4214825/C 02/2019

NOTES: (continued)

8. Laser cutting apertures with trapezoidal walls and rounded corners may offer better paste release. IPC-7525 may have alternate design recommendations.
9. Board assembly site may have different recommendations for stencil design.



# DBV0006A



## PACKAGE OUTLINE

SOT-23 - 1.45 mm max height

SMALL OUTLINE TRANSISTOR



4214840/G 08/2024

### NOTES:

1. All linear dimensions are in millimeters. Any dimensions in parenthesis are for reference only. Dimensioning and tolerancing per ASME Y14.5M.
2. This drawing is subject to change without notice.
3. Body dimensions do not include mold flash or protrusion. Mold flash and protrusion shall not exceed 0.25 per side.
4. Leads 1,2,3 may be wider than leads 4,5,6 for package orientation.
5. Reference JEDEC MO-178.

# EXAMPLE BOARD LAYOUT

DBV0006A

SOT-23 - 1.45 mm max height

SMALL OUTLINE TRANSISTOR



LAND PATTERN EXAMPLE  
EXPOSED METAL SHOWN  
SCALE:15X



SOLDER MASK DETAILS

4214840/G 08/2024

NOTES: (continued)

- 6. Publication IPC-7351 may have alternate designs.
- 7. Solder mask tolerances between and around signal pads can vary based on board fabrication site.

# EXAMPLE STENCIL DESIGN

DBV0006A

SOT-23 - 1.45 mm max height

SMALL OUTLINE TRANSISTOR



SOLDER PASTE EXAMPLE  
BASED ON 0.125 mm THICK STENCIL  
SCALE:15X

4214840/G 08/2024

NOTES: (continued)

8. Laser cutting apertures with trapezoidal walls and rounded corners may offer better paste release. IPC-7525 may have alternate design recommendations.
9. Board assembly site may have different recommendations for stencil design.

# DGK0008A



# PACKAGE OUTLINE

VSSOP - 1.1 mm max height

SMALL OUTLINE PACKAGE



4214862/A 04/2023

**NOTES:**

PowerPAD is a trademark of Texas Instruments.

1. All linear dimensions are in millimeters. Any dimensions in parenthesis are for reference only. Dimensioning and tolerancing per ASME Y14.5M.
2. This drawing is subject to change without notice.
3. This dimension does not include mold flash, protrusions, or gate burrs. Mold flash, protrusions, or gate burrs shall not exceed 0.15 mm per side.
4. This dimension does not include interlead flash. Interlead flash shall not exceed 0.25 mm per side.
5. Reference JEDEC registration MO-187.

# EXAMPLE BOARD LAYOUT

DGK0008A

™ VSSOP - 1.1 mm max height

SMALL OUTLINE PACKAGE



LAND PATTERN EXAMPLE  
EXPOSED METAL SHOWN  
SCALE: 15X



SOLDER MASK DETAILS

4214862/A 04/2023

NOTES: (continued)

6. Publication IPC-7351 may have alternate designs.
7. Solder mask tolerances between and around signal pads can vary based on board fabrication site.
8. Vias are optional depending on application, refer to device data sheet. If any vias are implemented, refer to their locations shown on this view. It is recommended that vias under paste be filled, plugged or tented.
9. Size of metal pad may vary due to creepage requirement.

# EXAMPLE STENCIL DESIGN

DGK0008A

<sup>TM</sup> VSSOP - 1.1 mm max height

SMALL OUTLINE PACKAGE



SOLDER PASTE EXAMPLE  
SCALE: 15X

4214862/A 04/2023

NOTES: (continued)

11. Laser cutting apertures with trapezoidal walls and rounded corners may offer better paste release. IPC-7525 may have alternate design recommendations.
12. Board assembly site may have different recommendations for stencil design.

## 重要なお知らせと免責事項

TI は、技術データと信頼性データ（データシートを含みます）、設計リソース（リファレンス・デザインを含みます）、アプリケーションや設計に関する各種アドバイス、Web ツール、安全性情報、その他のリソースを、欠陥が存在する可能性のある「現状のまま」提供しており、商品性および特定目的に対する適合性の黙示保証、第三者の知的財産権の非侵害保証を含むいかなる保証も、明示的または黙示的にかかわらず拒否します。

これらのリソースは、TI 製品を使用する設計の経験を積んだ開発者への提供を意図したものです。(1) お客様のアプリケーションに適した TI 製品の選定、(2) お客様のアプリケーションの設計、検証、試験、(3) お客様のアプリケーションに該当する各種規格や、その他のあらゆる安全性、セキュリティ、規制、または他の要件への確実な適合に関する責任を、お客様のみが単独で負うものとします。

上記の各種リソースは、予告なく変更される可能性があります。これらのリソースは、リソースで説明されている TI 製品を使用するアプリケーションの開発の目的でのみ、TI はその使用をお客様に許諾します。これらのリソースに関して、他の目的で複製することや掲載することは禁止されています。TI や第三者の知的財産権のライセンスが付与されている訳ではありません。お客様は、これらのリソースを自身で使用した結果発生するあらゆる申し立て、損害、費用、損失、責任について、TI およびその代理人を完全に補償するものとし、TI は一切の責任を拒否します。

TI の製品は、[TI の販売条件](#)、または [ti.com](#) やかかる TI 製品の関連資料などのいずれかを通じて提供する適用可能な条項の下で提供されています。TI がこれらのリソースを提供することは、適用される TI の保証または他の保証の放棄の拡大や変更を意味するものではありません。

お客様がいかなる追加条項または代替条項を提案した場合でも、TI はそれらに異議を唱え、拒否します。

郵送先住所：Texas Instruments, Post Office Box 655303, Dallas, Texas 75265  
Copyright © 2024, Texas Instruments Incorporated