

OPA4H014-SEP 宇宙用強化プラスチック封止、11MHz、高精度、低ノイズ、RRO、JFET オペアンプ

1 特長

- 耐放射線特性
 - 単一イベント・ラッチアップ (SEL) 耐性: $43\text{MeV}\cdot\text{cm}^2/\text{mg}$
 - 30krad(Si) まで ELDRS フリー
 - すべてのウェハー・ロットについて、30krad(Si) までの吸収線量 (TID) RLAT (Radiation Lot Acceptance Test)
- 宇宙向けに強化されたプラスチック
 - Au ボンド・ワイヤと NiPdAu リード仕上げ
 - モールド・コンパウンドの改良による低いガス放出
 - 単一の製造、アセンブリ、テスト施設
 - 長い製品ライフ・サイクル
 - 長期にわたる製品変更通知
 - 製品のトレーサビリティ
- 非常に小さいオフセット・ドリフト: $1\mu\text{V}/^\circ\text{C}$ 以下
- 非常に小さいオフセット: $120\mu\text{V}$
- 低い入力バイアス電流: 10pA 以下
- 低いノイズ: $5.1\text{nV}/\sqrt{\text{Hz}}$
- スルーレート: $20\text{V}/\mu\text{s}$
- 低消費電流: 2mA 以下
- 入力電圧範囲に V^- 電源を含む
- 広い電源電圧範囲: $4.5\text{V}\sim 18\text{V}$

2 アプリケーション

- 衛星の健全性監視と遠隔測定
- 科学的探査ペイロード
- 姿勢と軌道の制御システム (AOCS)
- 衛星用電源システム (EPS)
- 通信ペイロード
- レーダー画像処理ペイロード

3 概要

OPA4H014-SEP は、優れたドリフト特性と小さい入力バイアス電流を特長とする低消費電力 JFET 入力オペアンプです。 V^- を含む入力範囲とレール・ツー・レールの出力を利用して、設計者は単一電源の高精度 A/D コンバータ (ADC) および D/A コンバータ (DAC) に接続できるだけでなく、JFET アンプの低ノイズ特性を活用できます。

OPA4H014-SEP は、11MHz のユニティ・ゲイン帯域幅と $20\text{V}/\mu\text{s}$ のスルーレートを実現するとともに、わずか 1.8mA (標準値) の静止電流しか消費しません。このデバイスは $4.5\text{V}\sim 18\text{V}$ の単一電源、または $\pm 2.25\text{V}\sim \pm 9\text{V}$ のデュアル電源で動作します。

このオペアンプは、最大 $43\text{MeV}\cdot\text{cm}^2/\text{mg}$ (SET) の放射線耐性を持つプラスチック 14 ピン TSSOP パッケージに封止されており、30krad(Si) まで ELDRS フリーです。

パッケージ情報

| 部品番号 | パッケージ ⁽¹⁾ | 本体サイズ (公称) |
|--------------|----------------------|-----------------|
| OPA4H014-SEP | TSSOP (14) | 5.00mm × 4.40mm |

- (1) 提供されているすべてのパッケージについては、データシートの末尾にあるパッケージ・オプションについての付録を参照してください。

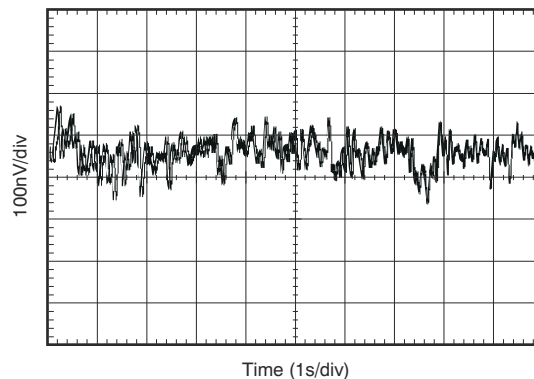

0.1Hz~10Hz のノイズ



Table of Contents

| | | | |
|--|----|--|----|
| 1 特長 | 1 | 7.4 Device Functional Modes..... | 14 |
| 2 アプリケーション | 1 | 8 Application and Implementation | 15 |
| 3 概要 | 1 | 8.1 Application Information..... | 15 |
| 4 Revision History | 2 | 8.2 Typical Application..... | 21 |
| 5 Pin Configuration and Functions | 3 | 8.3 Power Supply Recommendations..... | 22 |
| 6 Specifications | 4 | 8.4 Layout..... | 22 |
| 6.1 Absolute Maximum Ratings..... | 4 | 9 Device and Documentation Support | 24 |
| 6.2 ESD Ratings..... | 4 | 9.1 Device Support..... | 24 |
| 6.3 Recommended Operating Conditions..... | 4 | 9.2 Documentation Support..... | 24 |
| 6.4 Thermal Information..... | 4 | 9.3 Receiving Notification of Documentation Updates.... | 24 |
| 6.5 Electrical Characteristics..... | 5 | 9.4 サポート・リソース..... | 25 |
| 6.6 Typical Characteristics..... | 7 | 9.5 Trademarks..... | 25 |
| 7 Detailed Description | 13 | 9.6 Electrostatic Discharge Caution..... | 25 |
| 7.1 Overview..... | 13 | 9.7 Glossary..... | 25 |
| 7.2 Functional Block Diagram..... | 13 | 10 Mechanical, Packaging, and Orderable Information | 25 |
| 7.3 Feature Description..... | 14 | | |

4 Revision History

資料番号末尾の英字は改訂を表しています。その改訂履歴は英語版に準じています。

| Changes from Revision * (November 2021) to Revision A (April 2022) | Page |
|--|------|
| • デバイスを事前情報 (プレビュー) から量産データ (アクティブ) に変更..... | 1 |

5 Pin Configuration and Functions



图 5-1. PW (14-Pin TSSOP) Package, Top View

表 5-1. Pin Functions

| PIN | | TYPE | DESCRIPTION |
|-------|-----|--------|---------------------------------|
| NAME | NO. | | |
| +IN A | 3 | Input | Noninverting input, channel A |
| -IN A | 2 | Input | Inverting input, channel A |
| +IN B | 5 | Input | Noninverting input, channel B |
| -IN B | 6 | Input | Inverting input, channel B |
| +IN C | 10 | Input | Noninverting input, channel C |
| -IN C | 9 | Input | Inverting input, channel C |
| +IN D | 12 | Input | Noninverting input, channel D |
| -IN D | 13 | Input | Inverting input, channel D |
| OUT A | 1 | Output | Output, channel A |
| OUT B | 7 | Output | Output, channel B |
| OUT C | 8 | Output | Output, channel C |
| OUT D | 14 | Output | Output, channel D |
| V+ | 4 | Power | Positive (highest) power supply |
| V- | 11 | Power | Negative (lowest) power supply |

6 Specifications

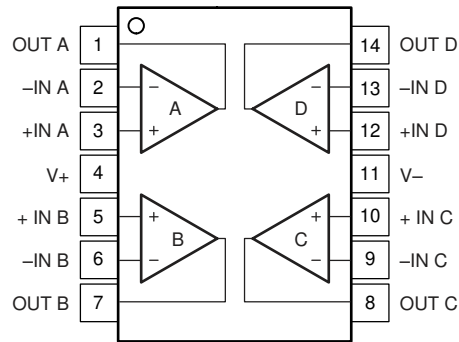
6.1 Absolute Maximum Ratings

over operating free-air temperature range (unless otherwise noted)⁽¹⁾

| | | | MIN | MAX | UNIT |
|------------------|-------------------------------------|---------------|------------|------------|------|
| V _S | Supply voltage, (V+) – (V–) | Dual supply | | ±10 | V |
| | | Single supply | | 20 | |
| | Signal input pins ⁽²⁾ | Voltage | (V–) – 0.5 | (V+) + 0.5 | V |
| | | Current | | ±10 | mA |
| | Output short-circuit ⁽³⁾ | | Continuous | Continuous | |
| T _A | Operating temperature | | –55 | 150 | °C |
| T _J | Junction temperature | | | 150 | °C |
| T _{stg} | Storage temperature | | –65 | 150 | °C |

- (1) Operation outside the Absolute Maximum Ratings may cause permanent device damage. Absolute Maximum Ratings do not imply functional operation of the device at these or any other conditions beyond those listed under Recommended Operating Conditions. If used outside the Recommended Operating Conditions but within the Absolute Maximum Ratings, the device may not be fully functional, and this may affect device reliability, functionality, performance, and shorten the device lifetime.
- (2) Input pins are diode-clamped to the power-supply rails. Input signals that can swing more than 0.5 V beyond the supply rails must be current limited to 10 mA or less.
- (3) Short-circuit to V_S / 2 (ground in symmetrical dual-supply setups), one amplifier per package.

6.2 ESD Ratings

| | | | VALUE | UNIT |
|--------------------|-------------------------|---|-------|------|
| V _(ESD) | Electrostatic discharge | Human-body model (HBM), per ANSI/ESDA/JEDEC JS-001 ⁽¹⁾ | ±2000 | V |
| | | Charged-device model (CDM), per ANSI/ESDA/JEDEC JS-002 ⁽²⁾ | ±500 | |

- (1) JEDEC document JEP155 states that 500-V HBM allows safe manufacturing with a standard ESD control process.
- (2) JEDEC document JEP157 states that 250-V CDM allows safe manufacturing with a standard ESD control process.

6.3 Recommended Operating Conditions

over operating free-air temperature range (unless otherwise noted)

| | | | MIN | NOM | MAX | UNIT |
|----------------|-----------------------------|---------------|-------|-----|-----|------|
| V _S | Supply voltage, (V+) – (V–) | Dual supply | ±2.25 | | ±9 | V |
| | | Single supply | 4.5 | | 18 | |
| T _A | Ambient temperature | | –55 | 25 | 125 | °C |

6.4 Thermal Information

| THERMAL METRIC ⁽¹⁾ | | OPA4H014-SEP | UNIT |
|-------------------------------|--|--------------|------|
| | | PW (TSSOP) | |
| | | 8 PINS | |
| R _{θJA} | Junction-to-ambient thermal resistance | 135 | °C/W |
| R _{θJC(top)} | Junction-to-case (top) thermal resistance | 45 | °C/W |
| R _{θJB} | Junction-to-board thermal resistance | 66 | °C/W |
| Ψ _{JT} | Junction-to-top characterization parameter | 19 | °C/W |
| Ψ _{JB} | Junction-to-board characterization parameter | 60 | °C/W |
| R _{θJC(bot)} | Junction-to-case (bottom) thermal resistance | N/A | °C/W |

- (1) For more information about traditional and new thermal metrics, see the [Semiconductor and IC Package Thermal Metrics](#) application report.

6.5 Electrical Characteristics

at $T_A = 25^\circ\text{C}$, $R_L = 2\text{ k}\Omega$ connected to midsupply, $V_S = \pm 2.25\text{ V}$ to $\pm 9\text{ V}$, and $V_{CM} = V_{OUT} = \text{midsupply}$ (unless otherwise noted)

| PARAMETER | | TEST CONDITIONS | MIN | TYP | MAX | UNIT |
|---------------------------|-------------------------------------|--|----------------------|------------------------|--------------|------------------------------|
| OFFSET VOLTAGE | | | | | | |
| V_{OS} | Input offset voltage | $V_S = \pm 9\text{ V}$, $T_A = -55^\circ\text{C}$ to $+125^\circ\text{C}$ | | ± 30 | ± 120 | μV |
| | | $T_A = -55^\circ\text{C}$ to $+125^\circ\text{C}$ | | | ± 220 | |
| dV_{OS}/dT | Drift | $V_S = \pm 9\text{ V}$, $T_A = -55^\circ\text{C}$ to $+125^\circ\text{C}$ | | ± 0.35 | ± 1 | $\mu\text{V}/^\circ\text{C}$ |
| PSRR | Power-supply rejection ratio | $T_A = -55^\circ\text{C}$ to $+125^\circ\text{C}$ | | ± 0.1 | ± 0.5 | $\mu\text{V}/\text{V}$ |
| | Channel separation | $f = \text{dc}$ | | 0.02 | | $\mu\text{V}/\text{V}$ |
| | | $f = 100\text{ kHz}$ | | 10 | | |
| INPUT BIAS CURRENT | | | | | | |
| I_B | Input bias current | | | ± 0.5 | ± 10 | pA |
| | | $T_A = -55^\circ\text{C}$ to $+125^\circ\text{C}$ | | | | ± 3 |
| I_{OS} | Input offset current | | | ± 0.5 | ± 10 | pA |
| | | $T_A = -55^\circ\text{C}$ to $+125^\circ\text{C}$ | | | | ± 1 |
| NOISE | | | | | | |
| | Input voltage noise | $f = 0.1\text{ Hz}$ to 10 Hz | | 250 | | nV_{PP} |
| | | $f = 0.1\text{ Hz}$ to 10 Hz | | 42 | | nV_{RMS} |
| e_n | Input voltage noise density | $f = 10\text{ Hz}$ | | 8 | | $\text{nV}/\sqrt{\text{Hz}}$ |
| | | $f = 100\text{ Hz}$ | | 5.8 | | |
| | | $f = 1\text{ kHz}$ | | 5.1 | | |
| I_n | Input current noise density | $f = 1\text{ kHz}$ | | 0.8 | | $\text{fA}/\sqrt{\text{Hz}}$ |
| INPUT VOLTAGE | | | | | | |
| V_{CM} | Common-mode voltage | $T_A = -55^\circ\text{C}$ to $+125^\circ\text{C}$ | $(V-) - 0.1$ | | $(V+) - 3.5$ | V |
| CMRR | Common-mode rejection ratio | $V_S = \pm 9\text{ V}$, $V_{CM} = (V-) - 0.1\text{ V}$ to $(V+) - 3.5\text{ V}$ | 126 | 140 | | dB |
| | | $V_S = \pm 9\text{ V}$, $V_{CM} = (V-) - 0.1\text{ V}$ to $(V+) - 3.5\text{ V}$, $T_A = -55^\circ\text{C}$ to $+125^\circ\text{C}$ | 120 | | | |
| INPUT IMPEDANCE | | | | | | |
| | Differential | | | $10^{13} \parallel 10$ | | $\Omega \parallel \text{pF}$ |
| | Common-mode | $V_{CM} = (V-) - 0.1\text{ V}$ to $(V+) - 3.5\text{ V}$ | | $10^{13} \parallel 7$ | | |
| OPEN-LOOP GAIN | | | | | | |
| A_{OL} | Open-loop voltage gain | $V_O = (V-) + 0.35\text{ V}$ to $(V+) - 0.35\text{ V}$, $R_L = 10\text{ k}\Omega$ | 120 | 126 | | dB |
| | | $V_O = (V-) + 0.35\text{ V}$ to $(V+) - 0.35\text{ V}$ | 114 | 126 | | |
| | | $V_O = (V-) + 0.35\text{ V}$ to $(V+) - 0.35\text{ V}$, $T_A = -55^\circ\text{C}$ to $+125^\circ\text{C}$ | 108 | | | |
| FREQUENCY RESPONSE | | | | | | |
| BW | Gain bandwidth product | | | 11 | | MHz |
| SR | Slew rate | | | 20 | | $\text{V}/\mu\text{s}$ |
| | Settling time | 12 bits | 10-V step, gain = +1 | 0.88 | | μs |
| | | 16 bits | 10-V step, gain = +1 | 1.6 | | |
| THD+N | Total harmonic distortion and noise | $f = 1\text{ kHz}$, gain = +1, $V_O = 3.5\text{ V}_{RMS}$ | | 0.00005% | | |
| | Overload recovery time | | | 600 | | ns |

6.5 Electrical Characteristics (continued)

at $T_A = 25^\circ\text{C}$, $R_L = 2\text{ k}\Omega$ connected to midsupply, $V_S = \pm 2.25\text{ V}$ to $\pm 9\text{ V}$, and $V_{CM} = V_{OUT} = \text{midsupply}$ (unless otherwise noted)

| PARAMETER | | TEST CONDITIONS | MIN | TYP | MAX | UNIT |
|---------------------|-----------------------------------|---|---|-----|---------------|----------|
| OUTPUT | | | | | | |
| | Output swing from rail | $R_L = 10\text{ k}\Omega$, $A_{OL} \geq 108\text{ dB}$ | $(V-) + 0.2$ | | $(V+) - 0.2$ | V |
| | | $A_{OL} \geq 108\text{ dB}$ | $(V-) + 0.35$ | | $(V+) - 0.35$ | |
| I_{SC} | Short-circuit current | Source | | 36 | | mA |
| | | Sink | | -30 | | |
| C_{LOAD} | Capacitive load drive | | See 6-17 and 6-18 | | | |
| Z_O | Open-loop output impedance | $f = 1\text{ MHz}$, $I_O = 0\text{ mA}$ | | 16 | | Ω |
| POWER SUPPLY | | | | | | |
| I_Q | Quiescent current (per amplifier) | $I_O = 0\text{ mA}$ | | 1.8 | 2 | mA |
| | | $T_A = -55^\circ\text{C}$ to $+125^\circ\text{C}$ | | | 2.7 | |

6.6 Typical Characteristics

at $T_A = 25^\circ\text{C}$, $V_S = \pm 9\text{ V}$, $R_L = 2\text{ k}\Omega$ connected to midsupply, and $V_{CM} = V_{OUT} = \text{midsupply}$ (unless otherwise noted)

表 6-1. Table of Graphs

| DESCRIPTION | FIGURE |
|--|---|
| Offset Voltage Production Distribution | 图 6-1 |
| Offset Voltage Drift Distribution | 图 6-2 |
| Offset Voltage vs Common-Mode Voltage (Maximum Supply) | 图 6-3 |
| I_B vs Common-Mode Voltage | 图 6-4 |
| Output Voltage Swing vs Output Current | 图 6-5 |
| CMRR and PSRR vs Frequency (RTI) | 图 6-6 |
| Common-Mode Rejection Ratio vs Temperature | 图 6-7 |
| 0.1-Hz to 10-Hz Noise | 图 6-8 |
| Input Voltage Noise Density vs Frequency | 图 6-9 |
| THD+N Ratio vs Frequency (80-kHz AP Bandwidth) | 图 6-10 |
| Quiescent Current vs Temperature | 图 6-11 |
| Quiescent Current vs Supply Voltage | 图 6-12 |
| Gain and Phase vs Frequency | 图 6-13 |
| Closed-Loop Gain vs Frequency | 图 6-14 |
| Open-Loop Gain vs Temperature | 图 6-15 |
| Open-Loop Output Impedance vs Frequency | 图 6-16 |
| Small-Signal Overshoot vs Capacitive Load ($G = 1$) | 图 6-17 |
| Small-Signal Overshoot vs Capacitive Load ($G = -1$) | 图 6-18 |
| No Phase Reversal | 图 6-19 |
| Maximum Output Voltage vs Frequency | 图 6-20 |
| Positive Overload Recovery | 图 6-21 |
| Negative Overload Recovery | 图 6-22 |
| Large-Signal Positive and Negative Settling Time | 图 6-23 , 图 6-24 |
| Small-Signal Step Response ($G = 1$) | 图 6-25 |
| Small-Signal Step Response ($G = -1$) | 图 6-26 |
| Large-Signal Step Response ($G = 1$) | 图 6-27 |
| Large-Signal Step Response ($G = -1$) | 图 6-28 |
| Short-Circuit Current vs Temperature | 图 6-29 |
| Channel Separation vs Frequency | 图 6-30 |

6.6 Typical Characteristics (continued)

at $T_A = 25^\circ\text{C}$, $V_S = \pm 9\text{ V}$, $R_L = 2\text{ k}\Omega$ connected to midsupply, and $V_{CM} = V_{OUT} = \text{midsupply}$ (unless otherwise noted)

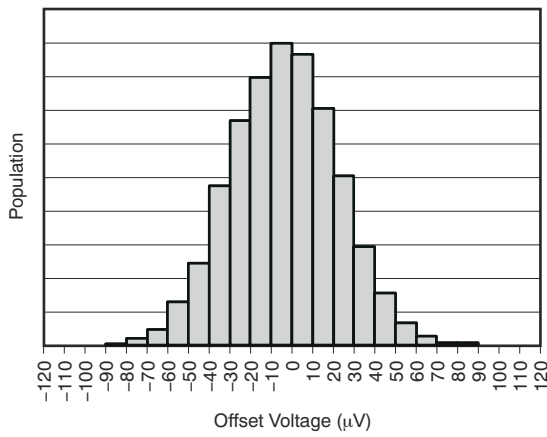

Fig 6-1. Offset Voltage Production Distribution

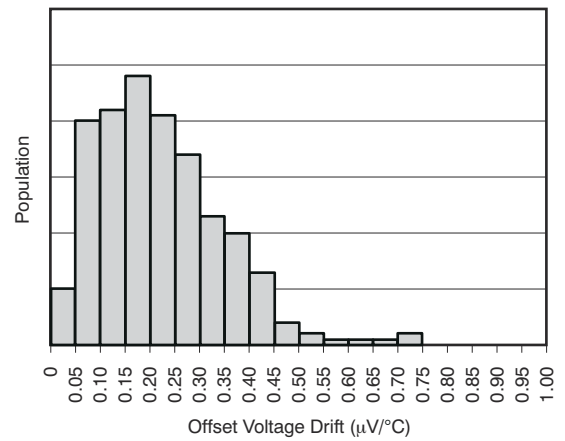

Fig 6-2. Offset Voltage Drift Distribution

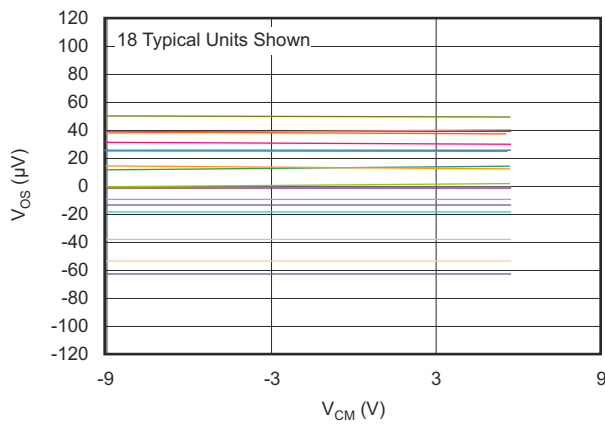

Fig 6-3. Offset Voltage vs Common-Mode Voltage

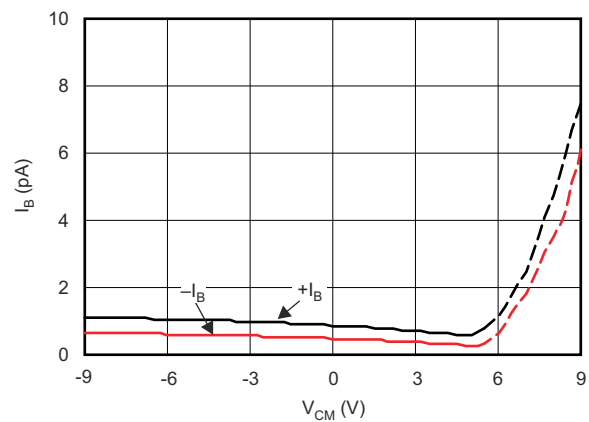

Fig 6-4. Bias Current vs Common-Mode Voltage

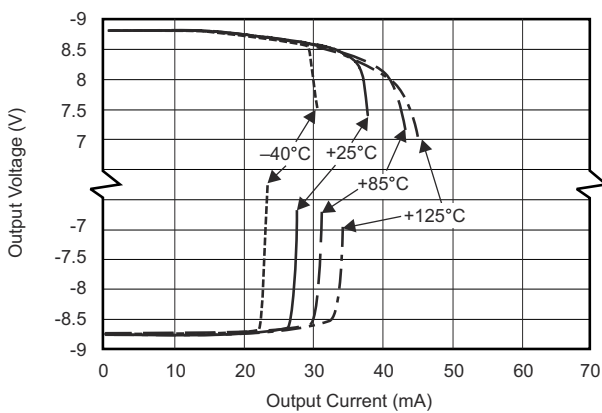

Fig 6-5. Output Voltage Swing vs Output Current (Maximum Supply)

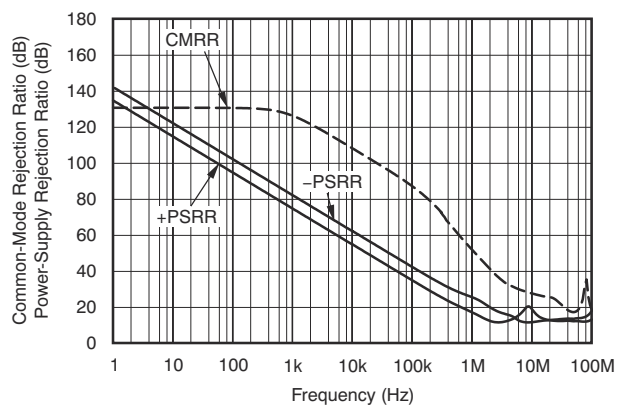
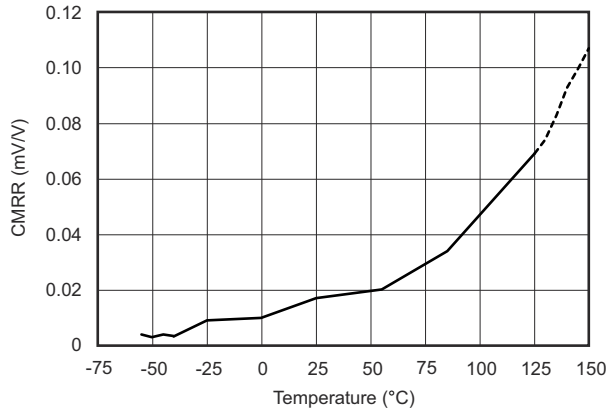

Fig 6-6. CMRR and PSRR vs Frequency (Referred to Input)

6.6 Typical Characteristics (continued)

at $T_A = 25^\circ\text{C}$, $V_S = \pm 9\text{ V}$, $R_L = 2\text{ k}\Omega$ connected to midsupply, and $V_{CM} = V_{OUT} = \text{midsupply}$ (unless otherwise noted)



6-7. Common-Mode Rejection Ratio vs Temperature

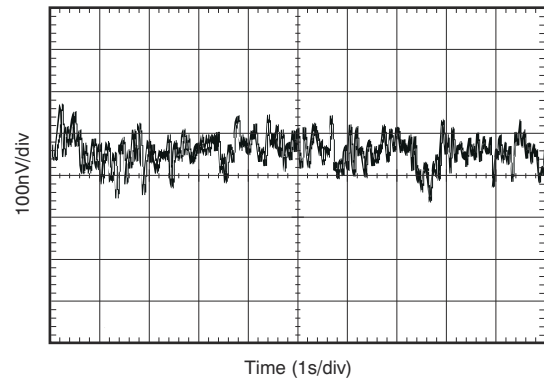

6-8. 0.1-Hz to 10-Hz Noise

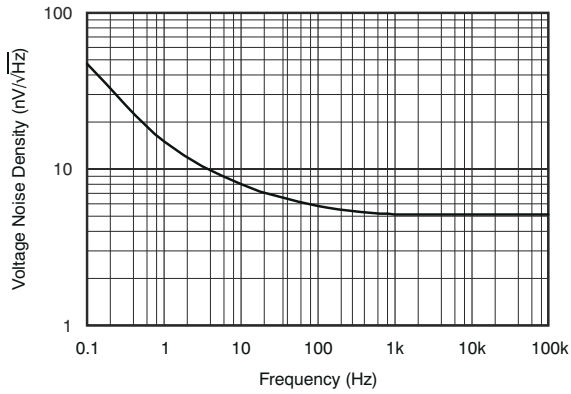

6-9. Input Voltage Noise Density vs Frequency

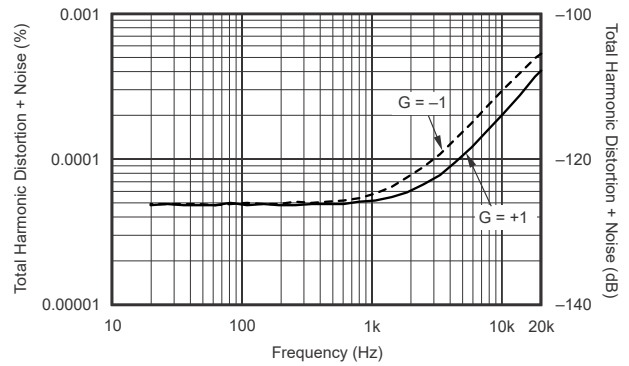

$V_{OUT} = 3 V_{RMS}$, $BW = 80\text{ kHz}$, $R_L = 2\text{ k}\Omega$

6-10. THD+N Ratio vs Frequency

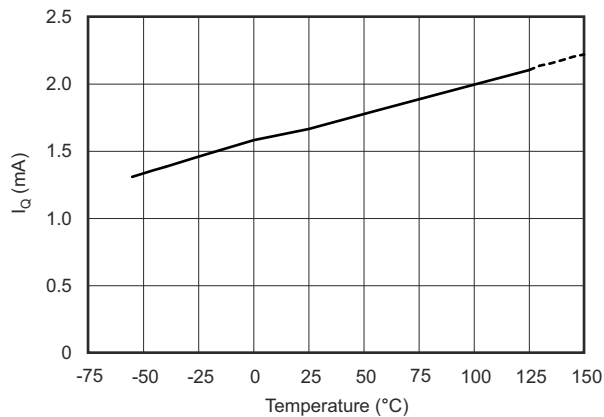

6-11. Quiescent Current vs Temperature

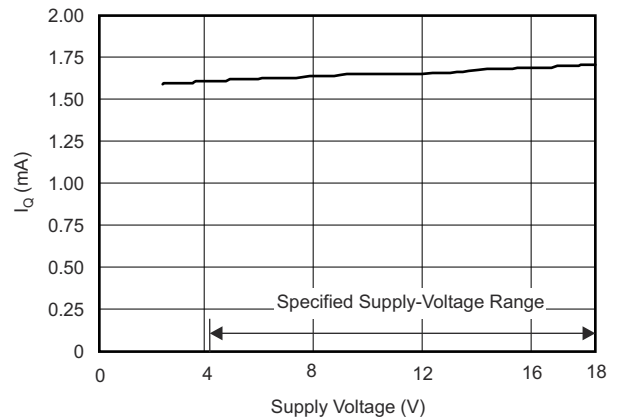

6-12. Quiescent Current vs Supply Voltage

6.6 Typical Characteristics (continued)

at $T_A = 25^\circ\text{C}$, $V_S = \pm 9\text{ V}$, $R_L = 2\text{ k}\Omega$ connected to midsupply, and $V_{CM} = V_{OUT} = \text{midsupply}$ (unless otherwise noted)

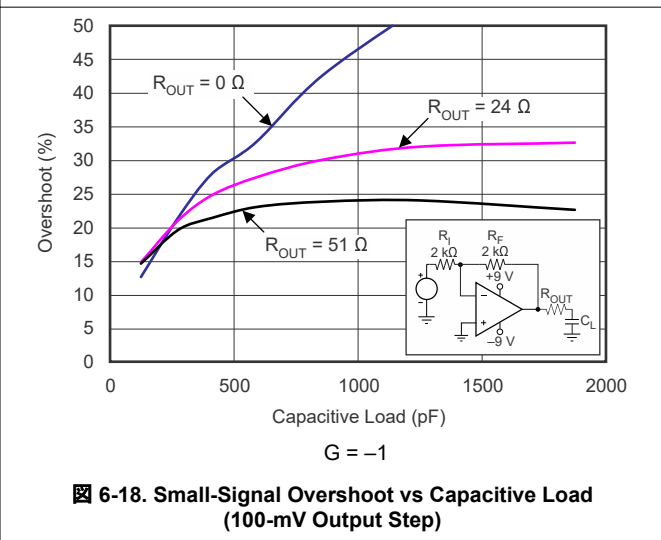
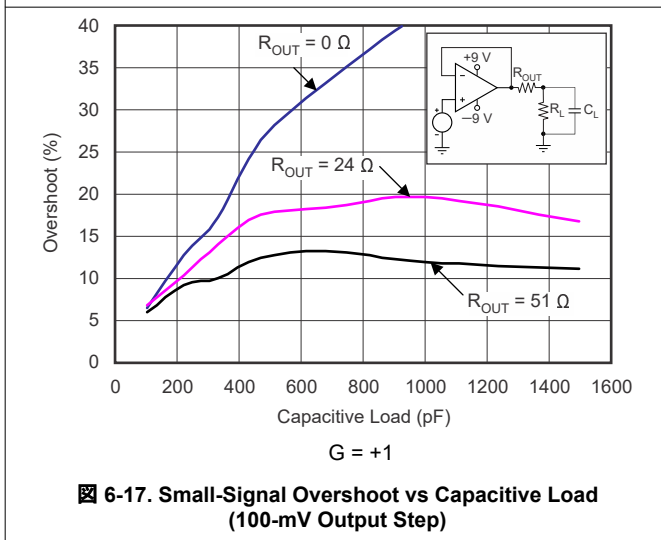
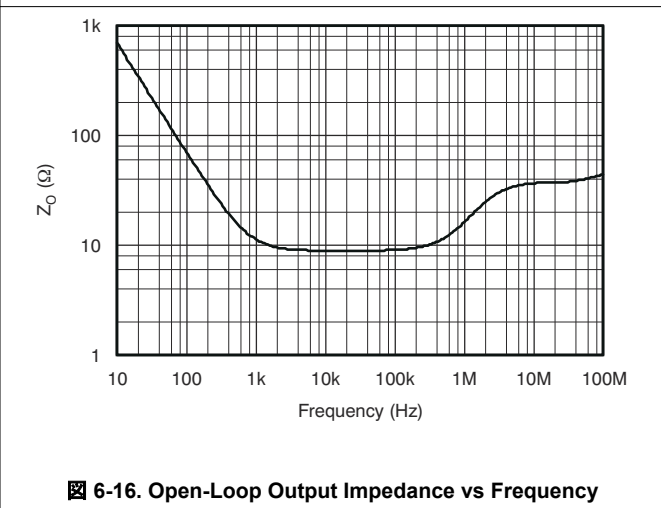
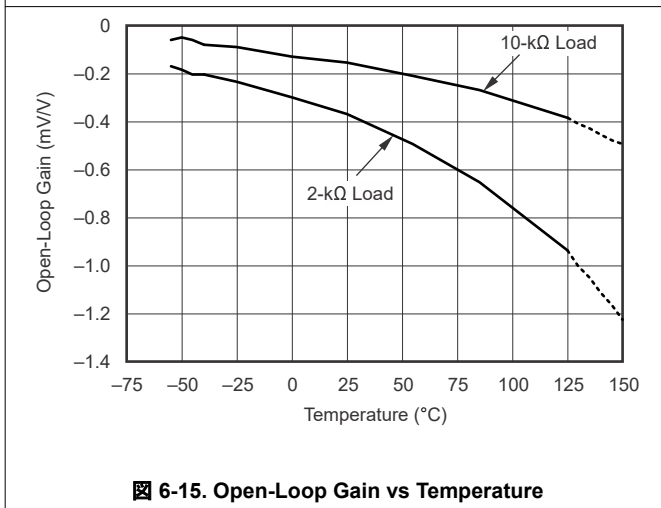
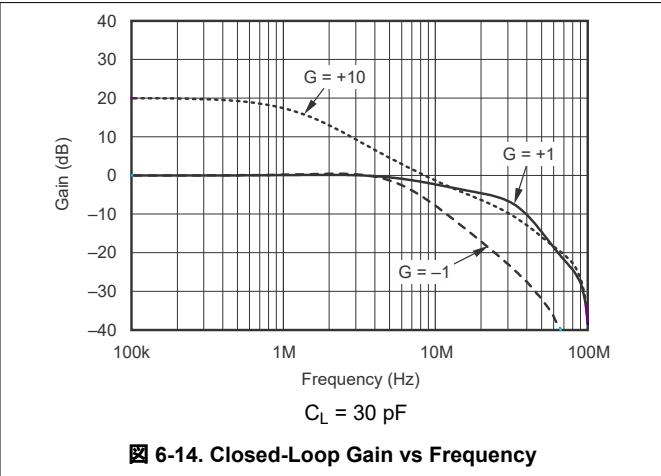
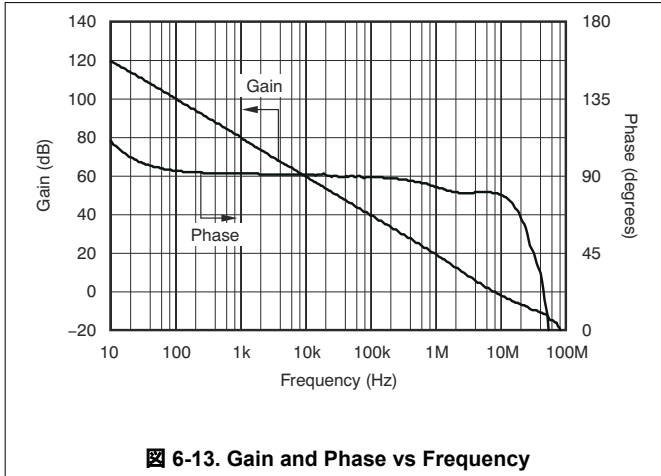

6.6 Typical Characteristics (continued)

at $T_A = 25^\circ\text{C}$, $V_S = \pm 9\text{ V}$, $R_L = 2\text{ k}\Omega$ connected to midsupply, and $V_{CM} = V_{OUT} = \text{midsupply}$ (unless otherwise noted)

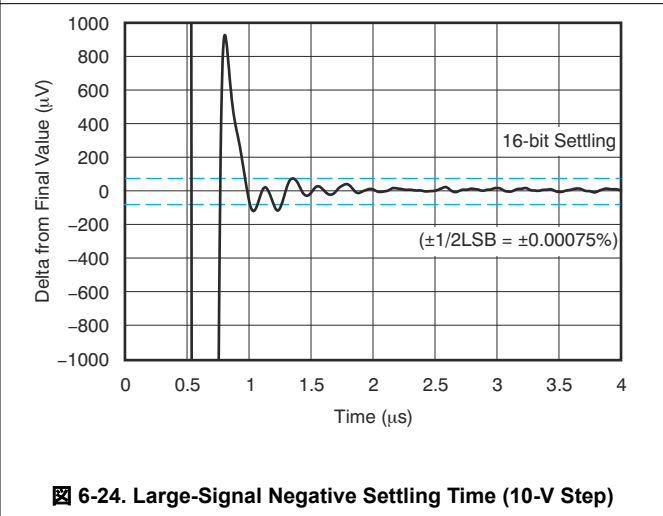
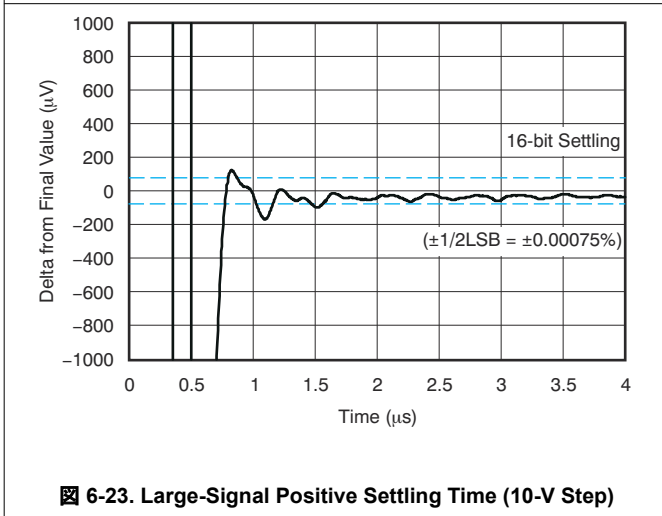
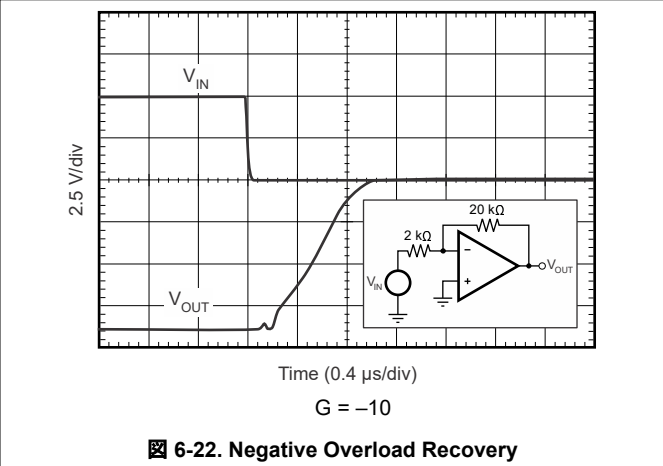
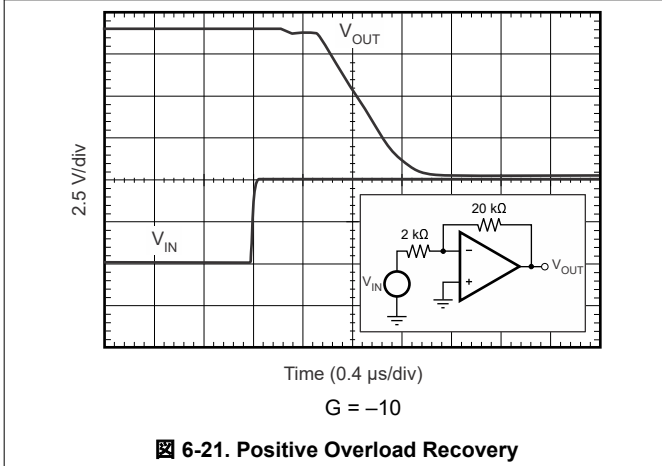
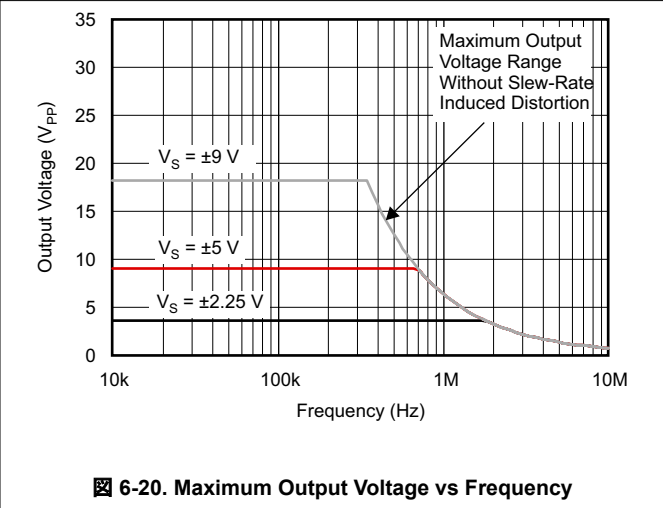
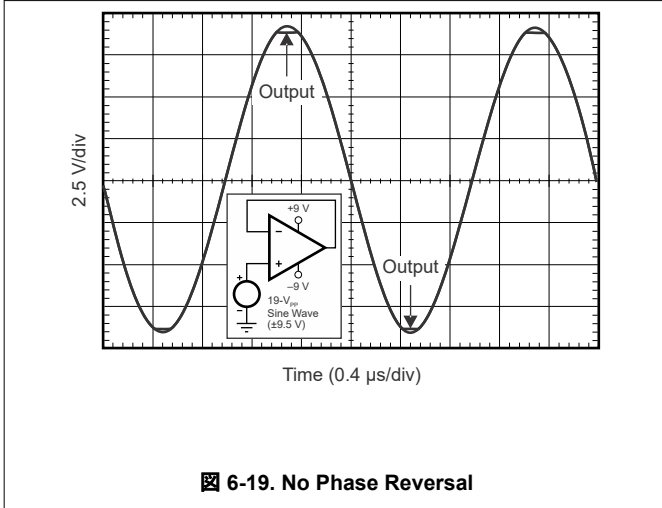

6.6 Typical Characteristics (continued)

at $T_A = 25^\circ\text{C}$, $V_S = \pm 9\text{ V}$, $R_L = 2\text{ k}\Omega$ connected to midsupply, and $V_{CM} = V_{OUT} = \text{midsupply}$ (unless otherwise noted)

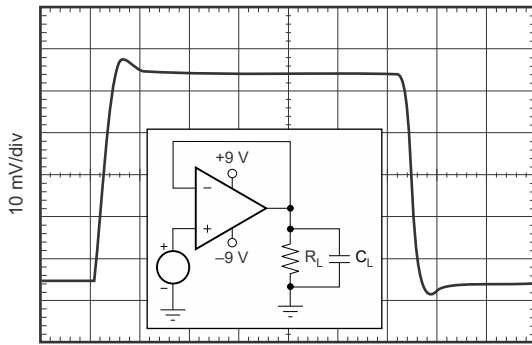

Time (100 ns/div)
 $G = +1$, $C_L = 100\text{ pF}$

6-25. Small-Signal Step Response (100 mV)

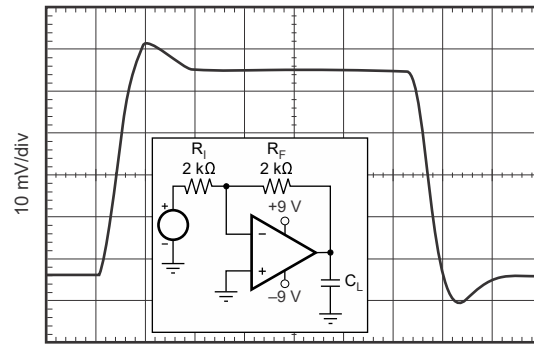

Time (100 ns/div)
 $G = -1$, $C_L = 100\text{ pF}$

6-26. Small-Signal Step Response (100 mV)

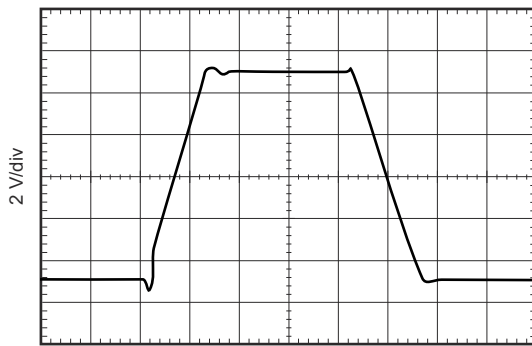

Time (400 ns/div)

6-27. Large-Signal Step Response

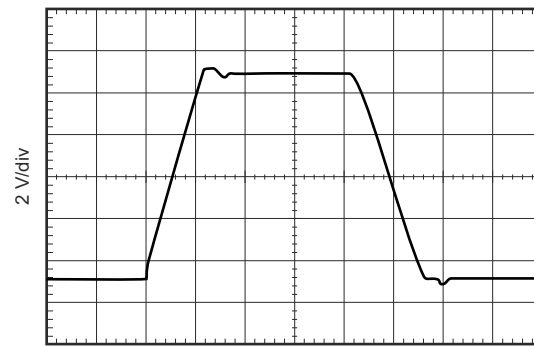

Time (400 ns/div)

6-28. Large-Signal Step Response

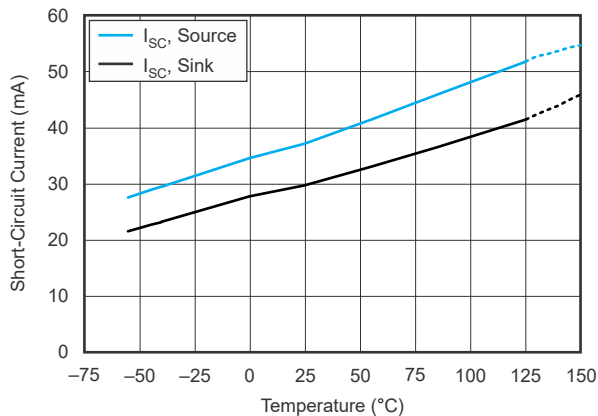

Short-circuiting may cause thermal shutdown;
see *Application Information* section

6-29. Short Circuit Current vs Temperature

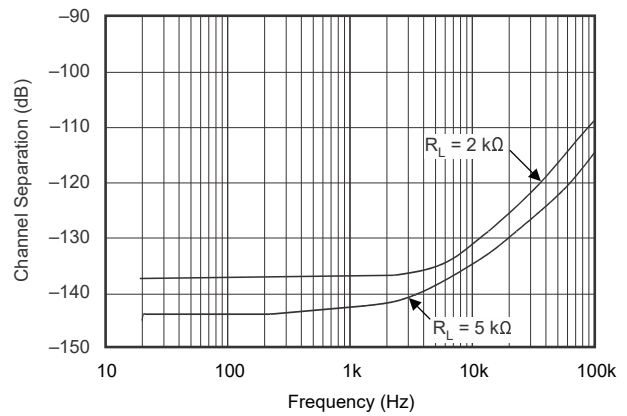

$V_{OUT} = 3 V_{RMS}$
 $G = +1$

6-30. Channel Separation vs Frequency

7 Detailed Description

7.1 Overview

The OPA4H014-SEP low-power, JFET-input operational amplifier features superior drift performance and low input bias current. Additional features include capacitive load stability, an output current limit, phase-reversal protection, and thermal protection. The rail-to-rail output swing and input range that includes V^- allows for the low-noise characteristics of JFET amplifiers while also interfacing to modern, single-supply, precision ADCs and DACs.

[セクション 7.2](#) shows the simplified diagram of the OPA4H014-SEP.

7.2 Functional Block Diagram

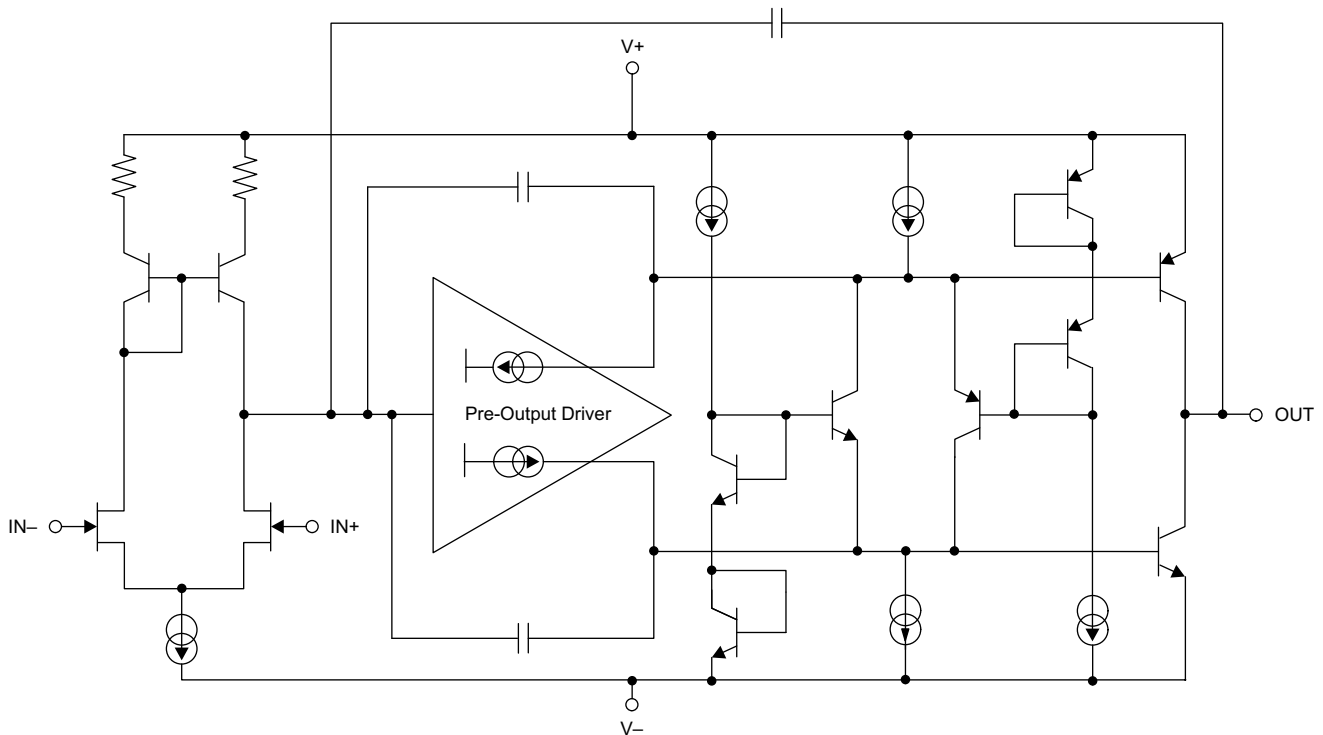

7.3 Feature Description

7.3.1 Capacitive Load and Stability

The dynamic characteristics of the OPA4H014-SEP are optimized for commonly encountered gains, loads, and operating conditions. The combination of low closed-loop gain and high capacitive loads decreases the phase margin of the amplifier and can lead to gain peaking or oscillations. As a result, heavier capacitive loads must be isolated from the output. The simplest way to achieve this isolation is to add a small resistor (R_{OUT} equal to 50 Ω , for example) in series with the output.

7.3.2 Output Current Limit

The output current of the OPA4H014-SEP is limited by internal circuitry to 36 mA (sourcing) and –30 mA (sinking), to protect the device if the output is accidentally shorted. This short-circuit current depends on temperature.

7.3.3 Phase-Reversal Protection

The OPA4H014-SEP family has internal phase-reversal protection. Many FET- and bipolar-input op amps exhibit a phase reversal when the input is driven beyond its linear common-mode range. This condition is most often encountered in noninverting circuits when the input is driven beyond the specified common-mode voltage range, causing the output to reverse into the opposite rail. The input circuitry of the OPA4H014-SEP prevents phase reversal with excessive common-mode voltage; instead, the output limits into the appropriate rail.

7.3.4 Thermal Protection

Although the output current of the OPA4H014-SEP is limited by internal protection circuitry, accidental shorting of one or more output channels of a device can result in excessive heating. For instance, when an output is shorted to midsupply, the typical short-circuit current of 36 mA leads to an internal power dissipation of over 300 mW at a supply of ± 9 V.

To prevent excessive heating leading to device damage, the OPA4H014-SEP series has an internal thermal shutdown circuit that shuts down the device if the die temperature exceeds approximately 180°C. When this thermal shutdown circuit activates, a built-in hysteresis of 15°C makes sure that the die temperature must drop to approximately 165°C before the device switches on again.

7.4 Device Functional Modes

The OPA4H014-SEP has a single functional mode and is operational when the power-supply voltage is greater than 4.5 V (± 2.25 V). The maximum power supply voltage for the OPA4H014-SEP is 18 V (± 9 V).

8 Application and Implementation

注

Information in the following applications sections is not part of the TI component specification, and TI does not warrant its accuracy or completeness. TI's customers are responsible for determining suitability of components for their purposes, as well as validating and testing their design implementation to confirm system functionality.

8.1 Application Information

The OPA4H014-SEP is a unity-gain stable, operational amplifier with very low noise, input bias current, and input offset voltage. Applications with noisy or high-impedance power supplies require decoupling capacitors placed close to the device pins. In most cases, 0.1- μ F capacitors are adequate. Designers can easily use the rail-to-rail output swing and input range that includes V₋ to take advantage of the low-noise characteristics of JFET amplifiers while also interfacing to modern, single-supply, precision data converters.

8.1.1 Noise Performance

The OPA4H014-SEP contributes both a voltage noise component and a current noise component. The voltage noise is commonly modeled as a time-varying component of the offset voltage. The current noise is modeled as the time-varying component of the input bias current and reacts with the source resistance to create a voltage component of noise. Therefore, the lowest noise op amp for a given application depends on the source impedance. For low source impedance, current noise is negligible, and voltage noise generally dominates. The OPA4H014-SEP has both low voltage noise and extremely low current noise because of the FET input of the op amp. As a result, the current noise contribution of the OPA4H014-SEP is negligible for any practical source impedance, which makes it the better choice for applications with high source impedance.

式 1 shows the calculation of the total circuit noise:

$$E_0^2 = e_n^2 + (i_n R_S)^2 + 4kTR_S \quad (1)$$

where

- e_n = voltage noise
- i_n = current noise
- R_S = source impedance
- k = Boltzmann's constant = 1.38×10^{-23} J/K
- T = temperature in kelvins (K)

For more details on calculating noise, see [セクション 8.1.1.1](#).

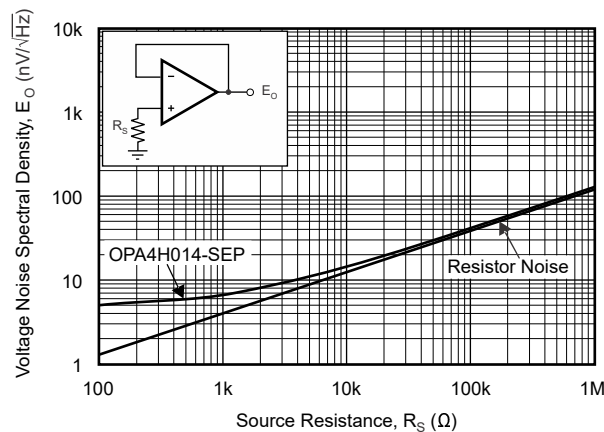

8-1. Noise Performance of the OPA4H014-SEP in Unity-Gain Buffer Configuration

8.1.1.1 Basic Noise Calculations

Low-noise circuit design requires careful analysis of all noise sources. External noise sources can dominate in many cases; consider the effect of source resistance on overall op amp noise performance. Total noise of the circuit is the root-sum-square combination of all noise components.

The resistive portion of the source impedance produces thermal noise proportional to the square root of the resistance. The source impedance is usually fixed; consequently, select an op amp and feedback resistors that minimize the respective contributions to the total noise.

☒ 8-2 illustrates both noninverting (A) and inverting (B) op amp circuit configurations with gain. In circuit configurations with gain, the feedback network resistors also contribute noise. In general, the current noise of the op amp reacts with the feedback resistors to create additional noise components. However, the extremely low current noise of the OPA4H014-SEP means that its current noise contribution can be neglected.

Choose feedback resistor values that make these noise sources negligible. Low impedance feedback resistors load the output of the amplifier. The equations for total noise are shown for both configurations.

A) Noise in Noninverting Gain Configuration

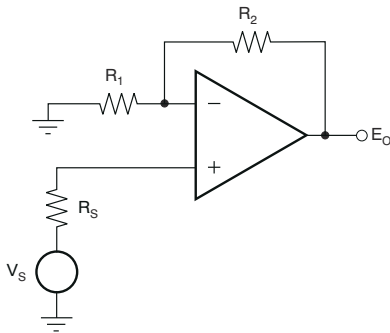

Noise at the output:

$$E_o^2 = \left(1 + \frac{R_2}{R_1}\right)^2 e_n^2 + \left(\frac{R_2}{R_1}\right)^2 e_1^2 + e_2^2 + \left(1 + \frac{R_2}{R_1}\right)^2 e_s^2$$

Where $e_s = \sqrt{4kTR_s}$ = thermal noise of R_s

$e_1 = \sqrt{4kTR_1}$ = thermal noise of R_1

$e_2 = \sqrt{4kTR_2}$ = thermal noise of R_2

B) Noise in Inverting Gain Configuration

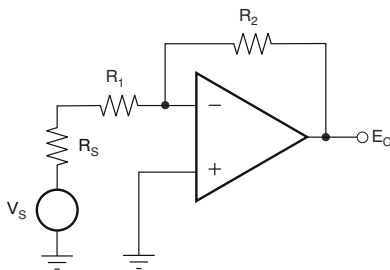

Noise at the output:

$$E_o^2 = \left(1 + \frac{R_2}{R_1 + R_s}\right)^2 e_n^2 + \left(\frac{R_2}{R_1 + R_s}\right)^2 e_1^2 + e_2^2 + \left(\frac{R_2}{R_1 + R_s}\right)^2 e_s^2$$

Where $e_s = \sqrt{4kTR_s}$ = thermal noise of R_s

$e_1 = \sqrt{4kTR_1}$ = thermal noise of R_1

$e_2 = \sqrt{4kTR_2}$ = thermal noise of R_2

Note: For the OPA4H014-SEP operational amplifier at 1 kHz, $e_n = 5.1 \text{ nV}/\sqrt{\text{Hz}}$.

☒ 8-2. Noise Calculation in Gain Configurations

8.1.2 Electrical Overstress

Designers often ask questions about the capability of an operational amplifier to withstand electrical overstress. These questions tend to focus on the device inputs, but may involve the supply voltage pins or even the output pin. Each of these different pin functions have electrical stress limits determined by the voltage breakdown characteristics of the particular semiconductor fabrication process and specific circuits connected to the pin. Additionally, internal electrostatic discharge (ESD) protection is built into these circuits to protect them from accidental ESD events both before and during product assembly.

A good understanding of this basic ESD circuitry and the relevance to an electrical overstress event is extremely helpful. [Figure 8-3](#) shows an illustration of the ESD circuits contained in the OPA4H014-SEP (indicated by the larger boxed area). The ESD protection circuitry involves several current-steering diodes connected from the input and output pins and routed back to the internal power-supply lines, where the diodes meet at an absorption device internal to the operational amplifier. This protection circuitry is intended to remain inactive during normal circuit operation.

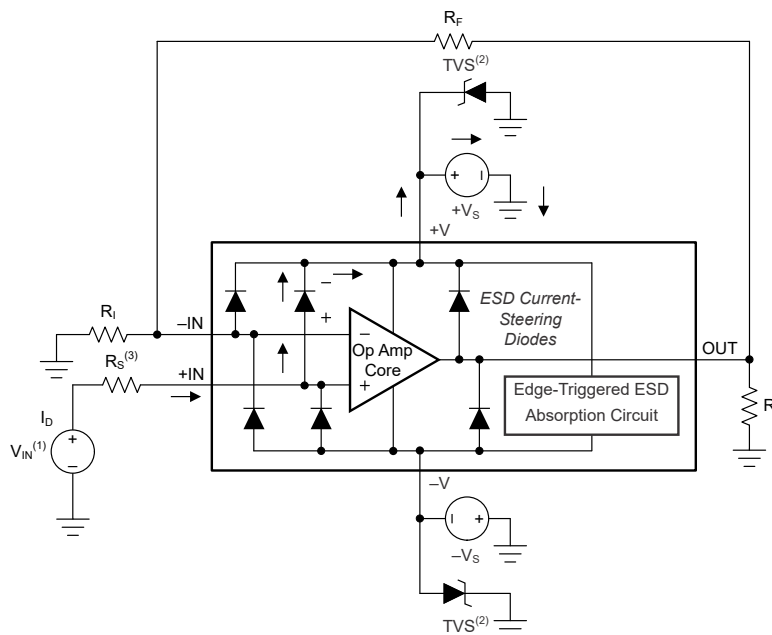

- (1) $V_{IN} = +V_S + 500 \text{ mV}$.
- (2) TVS: $+V_{S(max)} > V_{TVSBR (Min)} > +V_S$
- (3) Suggested value approximately $1 \text{ k}\Omega$.

Figure 8-3. Equivalent Internal ESD Circuitry Relative to a Typical Circuit Application

An ESD event produces a short-duration, high-voltage pulse that is transformed into a short-duration, high-current pulse while discharging through a semiconductor device. The ESD protection circuits are designed to provide a current path around the operational amplifier core to prevent damage. The energy absorbed by the protection circuitry is then dissipated as heat.

When an ESD voltage develops across two or more of the amplifier device pins, current flows through one or more of the steering diodes. Depending on the path that the current takes, the absorption device may activate. The absorption device has a trigger, or threshold voltage, that is greater than the normal operating voltage of the OPA4H014-SEP but less than the device breakdown voltage level. When this threshold is exceeded, the absorption device quickly activates and clamps the voltage across the supply rails to a safe level.

[Figure 8-3](#) shows that when the operational amplifier connects into a circuit, the ESD protection components are intended to remain inactive and not become involved in the application circuit operation. However, circumstances may arise where an applied voltage exceeds the operating voltage range of a given pin. If this condition occurs, there is a risk that some of the internal ESD protection circuits may be biased on, and conduct current. Any such current flow occurs through steering diode paths and rarely involves the absorption device.

✎ 8-3 shows a specific example where the input voltage (V_{IN}) exceeds the positive supply voltage ($+V_S$) by 500 mV or more. Much of what happens in the circuit depends on the supply characteristics. If $+V_S$ can sink the current, one of the upper input steering diodes conducts and directs current to $+V_S$. Excessively high current levels can flow with increasingly higher V_{IN} . As a result, the data sheet specifications recommend that applications limit the input current to 10 mA.

If the supply is not capable of sinking the current, V_{IN} may begin sourcing current to the operational amplifier, and then take over as the source of positive supply voltage. The danger in this case is that the voltage can rise to levels that exceed the operational amplifier absolute maximum ratings.

Another common question involves what happens to the amplifier if an input signal is applied to the input while the power supplies $+V_S$ or $-V_S$ are at 0 V. Again, the answer depends on the supply characteristic while at 0 V, or at a level below the input signal amplitude. If the supplies appear as high impedance, then the operational amplifier supply current may be supplied by the input source through the current steering diodes. This state is not a normal bias condition; the amplifier most likely will not operate normally. If the supplies are low impedance, then the current through the steering diodes can become quite high. The current level depends on the ability of the input source to deliver current, and any resistance in the input path.

If there is an uncertainty about the ability of the supply to absorb this current, external Zener diodes may be added to the supply pins, as shown in ✎ 8-3. The Zener voltage must be selected such that the diode does not turn on during normal operation. However, the Zener voltage must be low enough so that the Zener diode conducts if the supply pin begins to rise above the safe operating supply voltage level.

8.1.3 EMI Rejection

The electromagnetic interference (EMI) rejection ratio, or EMIRR, describes the EMI immunity of operational amplifiers. An adverse effect that is common to many op amps is a change in the offset voltage as a result of RF signal rectification. An op amp that is more efficient at rejecting this change in offset as a result of EMI has a higher EMIRR and is quantified by a decibel value. Measuring EMIRR can be performed in many ways, but this section provides the EMIRR IN+, which specifically describes the EMIRR performance when the RF signal is applied to the noninverting input pin of the op amp. In general, only the noninverting input is tested for EMIRR for the following three reasons:

- Op amp input pins are known to be the most sensitive to EMI, and typically rectify RF signals better than the supply or output pins.
- The noninverting and inverting op amp inputs have symmetrical physical layouts and exhibit nearly matching EMIRR performance
- EMIRR is easier to measure on noninverting pins than on other pins because the noninverting input terminal can be isolated on a PCB. This isolation allows the RF signal to be applied directly to the noninverting input pin with no complex interactions from other components or connecting PCB traces.

The EMIRR IN+ of the OPA4H014-SEP is plotted versus frequency as shown in ✎ 8-4. If available, any dual and quad op-amp device versions have nearly similar EMIRR IN+ performance. The OPA4H014-SEP unity-gain bandwidth is 11 MHz. EMIRR performance less than this frequency denotes interfering signals that fall within the op-amp bandwidth.



图 8-4. OPA4H014-SEP EMIRR

For more information, see the [EMI Rejection Ratio of Operational Amplifiers application report](#), available for download from www.ti.com.

表 8-1 lists the EMIRR IN+ values for the OPA4H014-SEP at particular frequencies commonly encountered in real-world applications. Applications listed in 表 8-1 may be centered on or operated near the particular frequency shown. This information may be of special interest to designers working with these types of applications, or working in other fields likely to encounter RF interference from broad sources, such as the industrial, scientific, and medical (ISM) radio band.

表 8-1. OPA4H014-SEP EMIRR IN+ for Frequencies of Interest

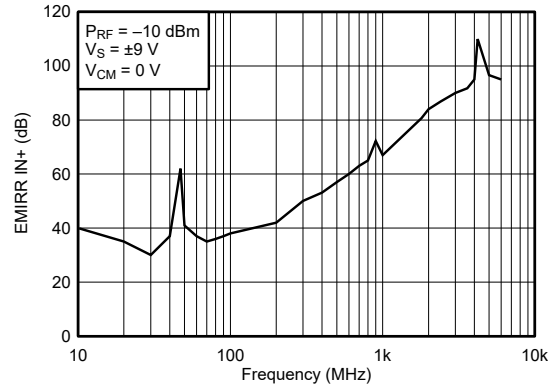
| FREQUENCY | APPLICATION OR ALLOCATION | EMIRR IN+ |
|-----------|--|-----------|
| 400 MHz | Mobile radio, mobile satellite, space operation, weather, radar, ultra-high frequency (UHF) applications | 53.1 dB |
| 900 MHz | Global system for mobile communications (GSM) applications, radio communication, navigation, GPS (to 1.6 GHz), GSM, aeronautical mobile, UHF applications | 72.2 dB |
| 1.8 GHz | GSM applications, mobile personal communications, broadband, satellite, L-band (1 GHz to 2 GHz) | 80.7 dB |
| 2.4 GHz | 802.11b, 802.11g, 802.11n, Bluetooth®, mobile personal communications, industrial, scientific and medical (ISM) radio band, amateur radio and satellite, S-band (2 GHz to 4 GHz) | 86.8 dB |
| 3.6 GHz | Radiolocation, aero communication and navigation, satellite, mobile, S-band | 91.7 dB |
| 5 GHz | 802.11a, 802.11n, aero communication and navigation, mobile communication, space and satellite operation, C-band (4 GHz to 8 GHz) | 96.6 dB |

8.1.4 EMIRR +IN Test Configuration

图 8-5 shows the circuit configuration for testing the EMIRR IN+. An RF source is connected to the op-amp noninverting input pin using a transmission line. The op amp is configured in a unity gain buffer topology with the output connected to a low-pass filter (LPF) and a digital multimeter (DMM). A large impedance mismatch at the op amp input causes a voltage reflection; however, this effect is characterized and accounted for when determining the EMIRR IN+. The resulting dc offset voltage is sampled and measured by the multimeter. The LPF isolates the multimeter from residual RF signals that may interfere with multimeter accuracy.

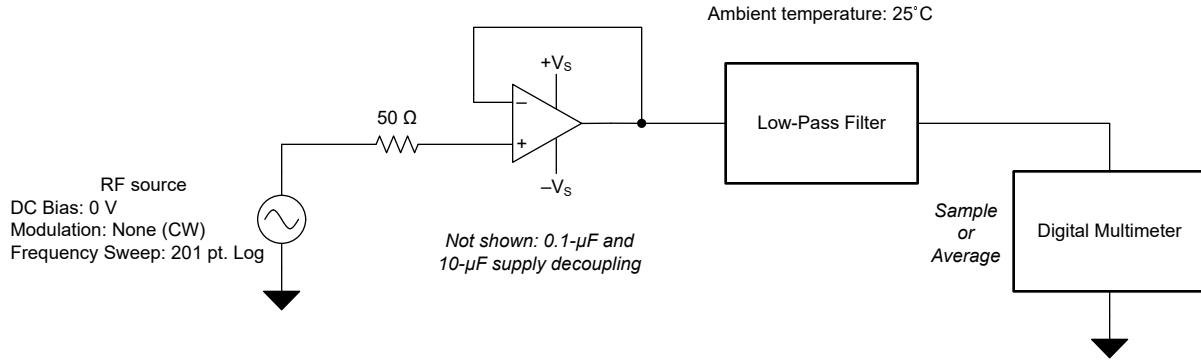

8-5. EMIRR +IN Test Configuration

8.2 Typical Application

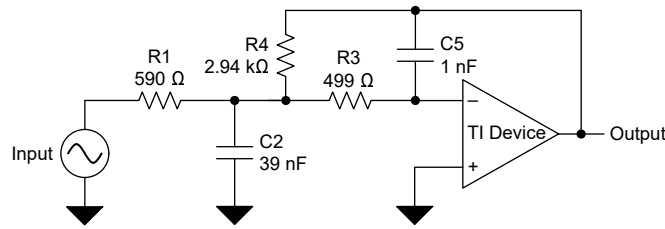

8-6. 25-kHz Low-Pass Filter

8.2.1 Design Requirements

Low-pass filters are commonly employed in signal processing applications to reduce noise and prevent aliasing. The OPA4H014-SEP is an excellent choice to construct high-speed, high-precision active filters. 8-6 shows a second-order, low-pass filter commonly encountered in signal processing applications.

Use the following parameters for this design example:

- Gain = 5 V/V (inverting gain)
- Low-pass cutoff frequency = 25 kHz
- Second-order Chebyshev filter response with 3-dB gain peaking in the pass band

8.2.2 Detailed Design Procedure

8-6 shows the infinite-gain multiple-feedback circuit for a low-pass network function. Use 2 to calculate the voltage transfer function.

$$\frac{\text{Output}}{\text{Input}}(s) = \frac{-1/R_1 R_3 C_2 C_5}{s^2 + (s/C_2)(1/R_1 + 1/R_3 + 1/R_4) + 1/R_3 R_4 C_2 C_5} \quad (2)$$

This circuit produces a signal inversion. For this circuit, the gain at dc and the low-pass cutoff frequency are calculated by 3:

$$\text{Gain} = \frac{R_4}{R_1}$$

$$f_C = \frac{1}{2\pi} \sqrt{1/R_3 R_4 C_2 C_5} \quad (3)$$

Software tools are readily available to simplify filter design. The [Filter Design Tool](#) is a simple, powerful, and easy-to-use active filter design program. The Filter Design Tool helps create optimized filter designs using a selection of TI operational amplifiers and passive components from TI's vendor partners.

Available as a web-based tool from the [Design tools and simulation](#) web page, the Filter Design Tool helps to design, optimize, and simulate complete multistage active filter solutions within minutes.

8.2.3 Application Curve



图 8-7. OPA4H014-SEP Second-Order, 25-kHz, Chebyshev, Low-Pass Filter

8.3 Power Supply Recommendations

The OPA4H014-SEP op amp is used with single or dual supplies from an operating range of $V_S = 4.5\text{ V} (\pm 2.25\text{ V})$ to $V_S = 18\text{ V} (\pm 9\text{ V})$. This device does not require symmetrical supplies, but only a minimum supply voltage of $4.5\text{ V} (\pm 2.25\text{ V})$. For V_S less than $\pm 3.5\text{ V}$, the common-mode input range does not include midsupply.

注意

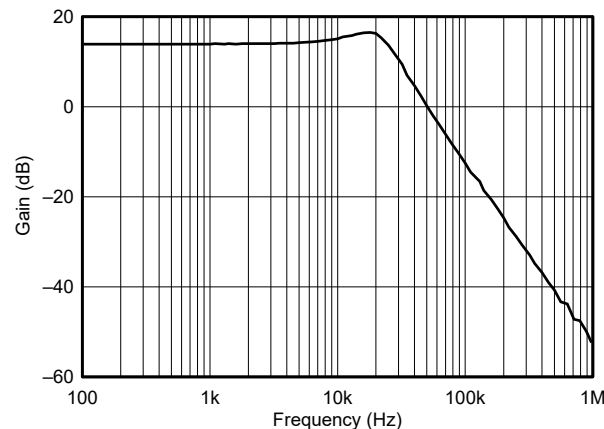
Supply voltages higher than 20 V can permanently damage the device; see [セクション 6.1](#).

Place 0.1- μF bypass capacitors close to the power-supply pins to reduce errors coupling in from noisy or high-impedance power supplies. For more detailed information on bypass capacitor placement, see [セクション 8.4](#).

Key parameters are specified over the operating temperature range, $T_A = -55^\circ\text{C}$ to $+125^\circ\text{C}$.

8.4 Layout

8.4.1 Layout Guidelines

For best operational performance of the device, use good PCB layout practices, including:

- Noise can propagate into analog circuitry through the power pins of the circuit as a whole and the op amp. Use bypass capacitors to reduce the coupled noise by providing low-impedance power sources local to the analog circuitry.
 - Connect low-ESR, 0.1- μF ceramic bypass capacitors between each supply pin and ground, placed as close as possible to the device. A single bypass capacitor from $V+$ to ground is applicable for single-supply applications.
- Separate grounding for analog and digital portions of circuitry is one of the simplest and most-effective methods of noise suppression. One or more layers on multilayer PCBs are usually devoted to ground planes. A ground plane helps distribute heat and reduces EMI noise pickup. Make sure to physically separate digital and analog grounds paying attention to the flow of the ground current.
- To reduce parasitic coupling, run the input traces as far away from the supply or output traces as possible. If these traces cannot be kept separate, crossing the sensitive trace perpendicular is much better as opposed to in parallel with the noisy trace.
- Place the external components as close to the device as possible. As illustrated in [图 8-8](#), keep RF and RG close to the inverting input to minimize parasitic capacitance.
- Keep the length of input traces as short as possible. Always remember that the input traces are the most sensitive part of the circuit.
- Consider a driven, low-impedance guard ring around the critical traces. A guard ring can significantly reduce leakage currents from nearby traces that are at different potentials.
- For best performance, clean the PCB following board assembly.

- Any precision integrated circuit may experience performance shifts due to moisture ingress into the plastic package. Following any aqueous PCB cleaning process, bake the PCB assembly to remove moisture introduced into the device packaging during the cleaning process. A low temperature, post cleaning bake at 85°C for 30 minutes is sufficient for most circumstances.

8.4.2 Layout Example

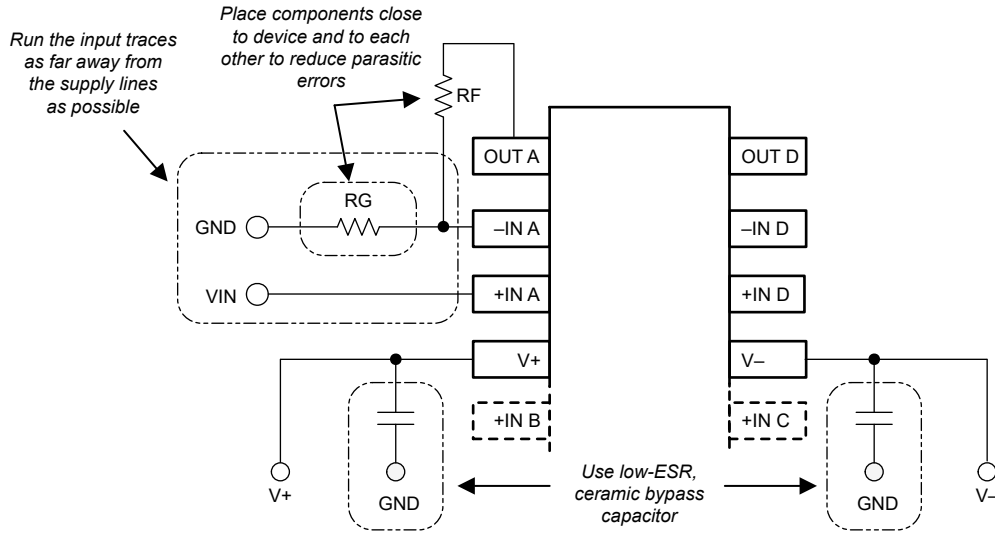

8-8. Operational Amplifier Board Layout for Noninverting Configuration

9 Device and Documentation Support

9.1 Device Support

9.1.1 Development Support

9.1.1.1 PSpice® for TI

PSpice® for TI は、アナログ回路の性能評価に役立つ設計およびシミュレーション環境です。レイアウトと製造に移る前に、サブシステムの設計とプロトタイプ・ソリューションを作成することで、開発コストを削減し、市場投入までの期間を短縮できます。

9.1.1.2 TINA-TI™ Simulation Software (Free Download)

TINA-TI™ simulation software is a simple, powerful, and easy-to-use circuit simulation program based on a SPICE engine. TINA-TI simulation software is a free, fully-functional version of the TINA™ software, preloaded with a library of macromodels, in addition to a range of both passive and active models. TINA-TI simulation software provides all the conventional dc, transient, and frequency domain analysis of SPICE, as well as additional design capabilities.

Available as a [free download](#) from the [Design tools and simulation](#) web page, TINA-TI simulation software offers extensive post-processing capability that allows users to format results in a variety of ways. Virtual instruments offer the ability to select input waveforms and probe circuit nodes, voltages, and waveforms, creating a dynamic quick-start tool.

注

These files require that either the TINA software or TINA-TI software be installed. Download the free TINA-TI simulation software from the [TINA-TI™ software folder](#).

9.1.1.3 Filter Design Tool

The [Filter Design Tool](#) is a simple, powerful, and easy-to-use active filter design program. The Filter Design Tool helps create optimized filter designs using a selection of TI operational amplifiers and passive components from TI's vendor partners.

Available as a web-based tool from the [Design tools and simulation](#) web page, The Filter Design Tool helps to design, optimize, and simulate complete multistage active filter solutions within minutes.

9.2 Documentation Support

9.2.1 Related Documentation

For related documentation see the following:

- Texas Instruments, [Compensate Transimpedance Amplifiers Intuitively](#) application report
- Texas Instruments, [Operational amplifier gain stability, Part 3: AC gain-error analysis](#)
- Texas Instruments, [Operational amplifier gain stability, Part 2: DC gain-error analysis](#)
- Texas Instruments, [Using infinite-gain, MFB filter topology in fully differential active filters](#)
- Texas Instruments, [Op Amp Performance Analysis](#) application bulletin
- Texas Instruments, [Single-Supply Operation of Operational Amplifiers](#) application bulletin
- Texas Instruments, [Shelf-Life Evaluation of Lead-Free Component Finishes](#) application report
- Texas Instruments, [Feedback Plots Define Op Amp AC Performance](#) application bulletin
- Texas Instruments, [EMI Rejection Ratio of Operational Amplifiers Application Report](#) application report

9.3 Receiving Notification of Documentation Updates

To receive notification of documentation updates, navigate to the device product folder on [ti.com](#). Click on [Subscribe to updates](#) to register and receive a weekly digest of any product information that has changed. For change details, review the revision history included in any revised document.

9.4 サポート・リソース

TI E2E™ サポート・フォーラムは、エンジニアが検証済みの回答と設計に関するヒントをエキスパートから迅速かつ直接得ることができる場所です。既存の回答を検索したり、独自の質問をしたりすることで、設計に必要な支援を迅速に得ることができます。

リンクされているコンテンツは、該当する貢献者により、現状のまま提供されるものです。これらは TI の仕様を構成するものではなく、必ずしも TI の見解を反映したものではありません。TI の [使用条件](#)を参照してください。

9.5 Trademarks

TINA-TI™ and TI E2E™ are trademarks of Texas Instruments.

TINA™ is a trademark of DesignSoft, Inc.

Bluetooth® is a registered trademark of Bluetooth SIG, Inc.

PSpice® is a registered trademark of Cadence Design Systems, Inc.

すべての商標は、それぞれの所有者に帰属します。

9.6 Electrostatic Discharge Caution



This integrated circuit can be damaged by ESD. Texas Instruments recommends that all integrated circuits be handled with appropriate precautions. Failure to observe proper handling and installation procedures can cause damage.

ESD damage can range from subtle performance degradation to complete device failure. Precision integrated circuits may be more susceptible to damage because very small parametric changes could cause the device not to meet its published specifications.

9.7 Glossary

[TI Glossary](#) This glossary lists and explains terms, acronyms, and definitions.

10 Mechanical, Packaging, and Orderable Information

The following pages include mechanical, packaging, and orderable information. This information is the most current data available for the designated devices. This data is subject to change without notice and revision of this document. For browser-based versions of this data sheet, refer to the left-hand navigation.

PACKAGING INFORMATION

| Orderable Device | Status (1) | Package Type | Package Drawing | Pins | Package Qty | Eco Plan (2) | Lead finish/ Ball material (6) | MSL Peak Temp (3) | Op Temp (°C) | Device Marking (4/5) | Samples |
|------------------|---------------|--------------|-----------------|------|-------------|-----------------|--------------------------------------|----------------------|--------------|-------------------------|-------------------------|
| OPA4H014PWSEP | ACTIVE | TSSOP | PW | 14 | 90 | RoHS & Green | NIPDAU | Level-2-260C-1 YEAR | -55 to 125 | O4H01A | Samples |
| OPA4H014PWTSEP | ACTIVE | TSSOP | PW | 14 | 250 | RoHS & Green | NIPDAU | Level-2-260C-1 YEAR | -55 to 125 | O4H01A | Samples |

(1) The marketing status values are defined as follows:

ACTIVE: Product device recommended for new designs.

LIFEBUY: TI has announced that the device will be discontinued, and a lifetime-buy period is in effect.

NRND: Not recommended for new designs. Device is in production to support existing customers, but TI does not recommend using this part in a new design.

PREVIEW: Device has been announced but is not in production. Samples may or may not be available.

OBSOLETE: TI has discontinued the production of the device.

(2) **RoHS:** TI defines "RoHS" to mean semiconductor products that are compliant with the current EU RoHS requirements for all 10 RoHS substances, including the requirement that RoHS substance do not exceed 0.1% by weight in homogeneous materials. Where designed to be soldered at high temperatures, "RoHS" products are suitable for use in specified lead-free processes. TI may reference these types of products as "Pb-Free".

RoHS Exempt: TI defines "RoHS Exempt" to mean products that contain lead but are compliant with EU RoHS pursuant to a specific EU RoHS exemption.

Green: TI defines "Green" to mean the content of Chlorine (Cl) and Bromine (Br) based flame retardants meet JS709B low halogen requirements of <=1000ppm threshold. Antimony trioxide based flame retardants must also meet the <=1000ppm threshold requirement.

(3) MSL, Peak Temp. - The Moisture Sensitivity Level rating according to the JEDEC industry standard classifications, and peak solder temperature.

(4) There may be additional marking, which relates to the logo, the lot trace code information, or the environmental category on the device.

(5) Multiple Device Markings will be inside parentheses. Only one Device Marking contained in parentheses and separated by a "~" will appear on a device. If a line is indented then it is a continuation of the previous line and the two combined represent the entire Device Marking for that device.

(6) Lead finish/Ball material - Orderable Devices may have multiple material finish options. Finish options are separated by a vertical ruled line. Lead finish/Ball material values may wrap to two lines if the finish value exceeds the maximum column width.

Important Information and Disclaimer:The information provided on this page represents TI's knowledge and belief as of the date that it is provided. TI bases its knowledge and belief on information provided by third parties, and makes no representation or warranty as to the accuracy of such information. Efforts are underway to better integrate information from third parties. TI has taken and continues to take reasonable steps to provide representative and accurate information but may not have conducted destructive testing or chemical analysis on incoming materials and chemicals. TI and TI suppliers consider certain information to be proprietary, and thus CAS numbers and other limited information may not be available for release.

In no event shall TI's liability arising out of such information exceed the total purchase price of the TI part(s) at issue in this document sold by TI to Customer on an annual basis.

TAPE AND REEL INFORMATION

QUADRANT ASSIGNMENTS FOR PIN 1 ORIENTATION IN TAPE



*All dimensions are nominal

| Device | Package Type | Package Drawing | Pins | SPQ | Reel Diameter (mm) | Reel Width W1 (mm) | A0 (mm) | B0 (mm) | K0 (mm) | P1 (mm) | W (mm) | Pin1 Quadrant |
|----------------|--------------|-----------------|------|-----|--------------------|--------------------|---------|---------|---------|---------|--------|---------------|
| OPA4H014PWTSEP | TSSOP | PW | 14 | 250 | 180.0 | 12.4 | 6.9 | 5.6 | 1.6 | 8.0 | 12.0 | Q1 |

TAPE AND REEL BOX DIMENSIONS

*All dimensions are nominal

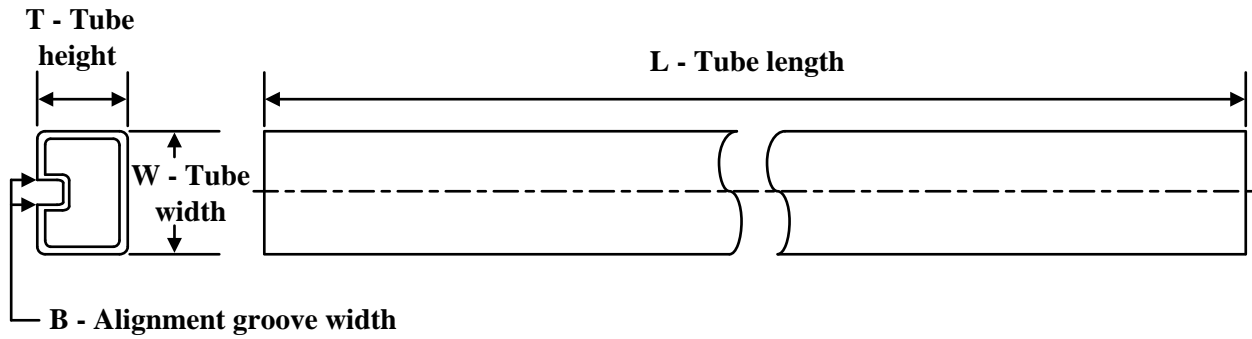
| Device | Package Type | Package Drawing | Pins | SPQ | Length (mm) | Width (mm) | Height (mm) |
|----------------|--------------|-----------------|------|-----|-------------|------------|-------------|
| OPA4H014PWTSEP | TSSOP | PW | 14 | 250 | 210.0 | 185.0 | 35.0 |

TUBE

*All dimensions are nominal

| Device | Package Name | Package Type | Pins | SPQ | L (mm) | W (mm) | T (μm) | B (mm) |
|---------------|--------------|--------------|------|-----|--------|--------|--------|--------|
| OPA4H014PWSEP | PW | TSSOP | 14 | 90 | 530 | 10.2 | 3600 | 3.5 |

PW0014A



PACKAGE OUTLINE
TSSOP - 1.2 mm max height

SMALL OUTLINE PACKAGE



4220202/B 12/2023

NOTES:

1. All linear dimensions are in millimeters. Any dimensions in parenthesis are for reference only. Dimensioning and tolerancing per ASME Y14.5M.
2. This drawing is subject to change without notice.
3. This dimension does not include mold flash, protrusions, or gate burrs. Mold flash, protrusions, or gate burrs shall not exceed 0.15 mm per side.
4. This dimension does not include interlead flash. Interlead flash shall not exceed 0.25 mm per side.
5. Reference JEDEC registration MO-153.

EXAMPLE BOARD LAYOUT

PW0014A

TSSOP - 1.2 mm max height

SMALL OUTLINE PACKAGE



LAND PATTERN EXAMPLE
EXPOSED METAL SHOWN
SCALE: 10X



4220202/B 12/2023

NOTES: (continued)

- 6. Publication IPC-7351 may have alternate designs.
- 7. Solder mask tolerances between and around signal pads can vary based on board fabrication site.

EXAMPLE STENCIL DESIGN

PW0014A

TSSOP - 1.2 mm max height

SMALL OUTLINE PACKAGE



SOLDER PASTE EXAMPLE
BASED ON 0.125 mm THICK STENCIL
SCALE: 10X

4220202/B 12/2023

NOTES: (continued)

8. Laser cutting apertures with trapezoidal walls and rounded corners may offer better paste release. IPC-7525 may have alternate design recommendations.
9. Board assembly site may have different recommendations for stencil design.

重要なお知らせと免責事項

TI は、技術データと信頼性データ（データシートを含みます）、設計リソース（リファレンス・デザインを含みます）、アプリケーションや設計に関する各種アドバイス、Web ツール、安全性情報、その他のリソースを、欠陥が存在する可能性のある「現状のまま」提供しており、商品性および特定目的に対する適合性の黙示保証、第三者の知的財産権の非侵害保証を含むいかなる保証も、明示的または黙示的にかかわらず拒否します。

これらのリソースは、TI 製品を使用する設計の経験を積んだ開発者への提供を意図したものです。(1) お客様のアプリケーションに適した TI 製品の選定、(2) お客様のアプリケーションの設計、検証、試験、(3) お客様のアプリケーションに該当する各種規格や、その他のあらゆる安全性、セキュリティ、規制、または他の要件への確実な適合に関する責任を、お客様のみが単独で負うものとします。

上記の各種リソースは、予告なく変更される可能性があります。これらのリソースは、リソースで説明されている TI 製品を使用するアプリケーションの開発の目的でのみ、TI はその使用をお客様に許諾します。これらのリソースに関して、他の目的で複製することや掲載することは禁止されています。TI や第三者の知的財産権のライセンスが付与されている訳ではありません。お客様は、これらのリソースを自身で使用した結果発生するあらゆる申し立て、損害、費用、損失、責任について、TI およびその代理人を完全に補償するものとし、TI は一切の責任を拒否します。

TI の製品は、[TI の販売条件](#)、または [ti.com](#) やかかる TI 製品の関連資料などのいずれかを通じて提供する適用可能な条項の下で提供されています。TI がこれらのリソースを提供することは、適用される TI の保証または他の保証の放棄の拡大や変更を意味するものではありません。

お客様がいかなる追加条項または代替条項を提案した場合でも、TI はそれらに異議を唱え、拒否します。

郵送先住所：Texas Instruments, Post Office Box 655303, Dallas, Texas 75265
Copyright © 2024, Texas Instruments Incorporated