

# OPAx388-Q1 車載用、高精度、ゼロドリフト、ゼロクロスオーバー、 真のレール・ツー・レール入出力のオペアンプ

## 1 特長

- 車載アプリケーション用に AEC-Q100 認定取得済み:
  - 温度グレード 1:  $-40^{\circ}\text{C} \sim +125^{\circ}\text{C}$ ,  $T_A$
- 機能安全に対応
  - 機能安全システムの設計に役立つ資料を利用可能 (OPA388-Q1)
  - 機能安全システムの設計に役立つ資料を利用可能 (OPA2388-Q1: VSSOP)
- ゼロドリフト:  $\pm 0.005\mu\text{V}/^{\circ}\text{C}$
- ゼロクロスオーバー: 140dB の CMRR、真の RRIO
- 低いノイズ: 1kHz 時に  $7.0\text{nV}/\sqrt{\text{Hz}}$
- 1/f ノイズなし:  $140\text{nV}_{\text{PP}}$  (0.1Hz~10Hz)
- 高速セトリング:  $2\mu\text{s}$  (1V ステップ、0.01% まで)
- ゲイン帯域幅: 10MHz
- 単一電源: 2.5V~5.5V
- デュアル電源:  $\pm 1.25\text{V} \sim \pm 2.75\text{V}$
- 真のレール・ツー・レール入力
- EMI および RFI フィルタ入力
- 業界標準パッケージ VSSOP-8、SOT-23-5

## 2 アプリケーション

- HEV/EV のインバータおよびモータ制御
- バッテリー管理システム (BMS)
- DC/DC コンバータ
- オンボード・チャージャ (OBC) とワイヤレス・チャージャ

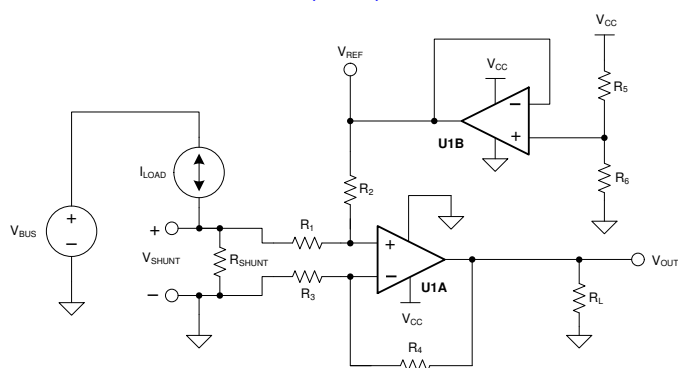

OPA388-Q1 による双方向電流シャント・モニタ

## 3 概要

OPA388-Q1 と OPA2388-Q1 (OPAx388-Q1) は、レール・ツー・レール入力および出力動作に対応した車載用、低ノイズ、高速セトリング、ゼロドリフトの高精度オペアンプです。OPAx388-Q1 は非常に優れた AC 性能を備え、全温度範囲でわずか  $0.25\mu\text{V}$  のオフセットと  $0.005\mu\text{V}/^{\circ}\text{C}$  の温度ドリフトを達成しているため、高分解能 A/D コンバータ (ADC) を高精度で駆動するのに最適です。ゼロクロスオーバー・テクノロジーは、すべてのオフセットの変化を同相範囲全体で最小限に抑えます。OPAx388-Q1 は低ドリフトと超低 1/f ノイズを兼ね備えているため、信号の整合性を損なうことなく障害条件を監視および検出できます。

これらのデバイスは、 $-40^{\circ}\text{C} \sim +125^{\circ}\text{C}$  の産業用温度範囲について仕様が規定されています。

### 製品情報

部品番号	パッケージ <sup>(1)</sup>	本体サイズ (公称)
OPA388-Q1	SOT-23 (5)	2.90mm × 1.60mm
OPA2388-Q1	SOIC (8) - プレビュー	4.90mm × 3.90mm
	VSSOP (8)	3.00mm × 3.00mm

- (1) 提供されているすべてのパッケージについては、データシートの末尾にあるパッケージ・オプションについての付録を参照してください。

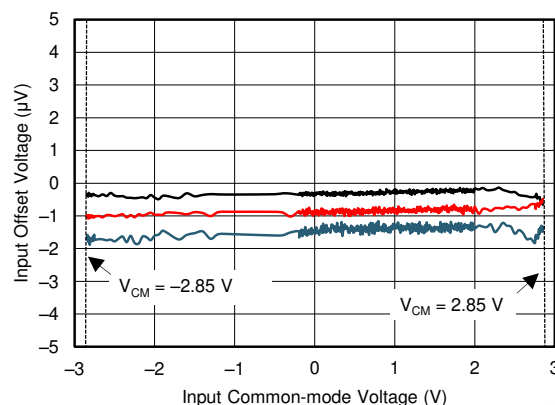

OPA388-Q1 の全コモンモード範囲にわたる非常に小さいオフセット



## Table of Contents

<b>1 特長</b> .....	<b>1</b>	<b>8 Application and Implementation</b> .....	<b>19</b>
<b>2 アプリケーション</b> .....	<b>1</b>	8.1 Application Information.....	19
<b>3 概要</b> .....	<b>1</b>	8.2 <b>Typical Application</b> .....	19
<b>4 Revision History</b> .....	<b>2</b>	<b>9 Power Supply Recommendations</b> .....	<b>22</b>
<b>5 Pin Configuration and Functions</b> .....	<b>3</b>	<b>10 Layout</b> .....	<b>22</b>
<b>6 Specifications</b> .....	<b>4</b>	10.1 Layout Guidelines.....	22
6.1 Absolute Maximum Ratings.....	4	10.2 Layout Example.....	22
6.2 ESD Ratings.....	4	<b>11 Device and Documentation Support</b> .....	<b>23</b>
6.3 Recommended Operating Conditions.....	4	11.1 Device Support.....	23
6.4 Thermal Information: OPA388-Q1.....	5	11.2 Documentation Support.....	23
6.5 Thermal Information: OPA2388-Q1.....	5	11.3 Receiving Notification of Documentation Updates..	23
6.6 Electrical Characteristics.....	6	11.4 サポート・リソース.....	23
6.7 Typical Characteristics.....	8	11.5 Trademarks.....	23
<b>7 Detailed Description</b> .....	<b>16</b>	11.6 Electrostatic Discharge Caution.....	24
7.1 Overview.....	16	11.7 Glossary.....	24
7.2 Functional Block Diagram.....	16	<b>12 Mechanical, Packaging, and Orderable</b>	
7.3 Feature Description.....	17	<b>Information</b> .....	<b>24</b>
7.4 Device Functional Modes.....	18		

## 4 Revision History

資料番号末尾の英字は改訂を表しています。その改訂履歴は英語版に準じています。

<b>Changes from Revision * (August 2020) to Revision A (November 2021)</b>	<b>Page</b>
• OPA2388-Q1 の量産データ (アクティブ) デバイスと関連する内容を追加.....	<b>1</b>

## 5 Pin Configuration and Functions

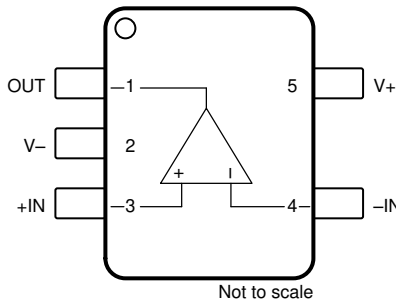

✎ 5-1. OPA388-Q1 DBV (5-Pin SOT-23) Package, Top View

### Pin Functions: OPA388-Q1

PIN		TYPE	DESCRIPTION
NAME	NO.		
-IN	4	Input	Inverting input
+IN	3	Input	Noninverting input
NC	—	—	No internal connection (can be left floating)
OUT	1	Output	Output
V-	2	Power	Negative (lowest) power supply
V+	5	Power	Positive (highest) power supply

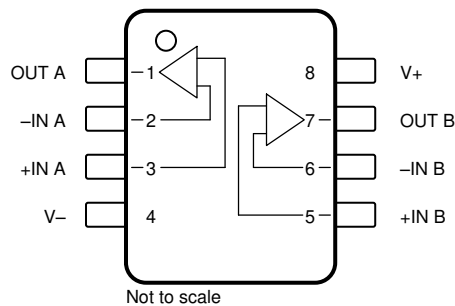

✎ 5-2. OPA2388-Q1 D (8-Pin SOIC, Preview) and DGK (8-Pin VSSOP) Packages, Top View

### Pin Functions: OPA2388-Q1

PIN		TYPE	DESCRIPTION
NAME	NO.		
-IN A	2	Input	Inverting input, channel A
-IN B	6	Input	Inverting input, channel B
+IN A	3	Input	Noninverting input, channel A
+IN B	5	Input	Noninverting input, channel B
OUT A	1	Output	Output, channel A
OUT B	7	Output	Output, channel B
V-	4	Power	Negative (lowest) power supply
V+	8	Power	Positive (highest) power supply

## 6 Specifications

### 6.1 Absolute Maximum Ratings

over operating free-air temperature range (unless otherwise noted)<sup>(1)</sup>

			MIN	MAX	UNIT
V <sub>S</sub>	Supply voltage, V <sub>S</sub> = (V+) – (V–)	Single-supply		6	V
		Dual-supply		±3	
	Signal input pins voltage	Common-mode	(V–) – 0.5	(V+) + 0.5	V
		Differential		(V+) – (V–) + 0.2	
	Signal input pins current			±10	mA
	Output short circuit <sup>(2)</sup>		Continuous	Continuous	
T <sub>A</sub>	Operating temperature		–55	150	°C
T <sub>J</sub>	Junction temperature			150	°C
T <sub>stg</sub>	Storage temperature		–65	150	°C

- (1) Stresses beyond those listed under *Absolute Maximum Ratings* may cause permanent damage to the device. These are stress ratings only, which do not imply functional operation of the device at these or any other conditions beyond those indicated under *Recommended Operating Conditions*. Exposure to absolute-maximum-rated conditions for extended periods may affect device reliability.
- (2) Short-circuit to ground, one amplifier per package.

### 6.2 ESD Ratings

			VALUE	UNIT
V <sub>(ESD)</sub>	Electrostatic discharge	Human-body model (HBM), per AEC Q100-002 <sup>(1)</sup> HBM ESD classification level 2	±2000	V
		Charged-device model (CDM), per AEC Q100-011 CDM ESD classification level C5	±750	

- (1) AEC Q100-002 indicates that HBM stressing shall be in accordance with the ANSI/ESDA/JEDEC JS-001 specification

### 6.3 Recommended Operating Conditions

over operating free-air temperature range (unless otherwise noted)

			MIN	NOM	MAX	UNIT
V <sub>S</sub>	Supply voltage, V <sub>S</sub> = (V+) – (V–)	Single-supply	2.5		5.5	V
		Dual-supply	±1.25		±2.75	
T <sub>A</sub>	Specified temperature		–40		125	°C

## 6.4 Thermal Information: OPA388-Q1

THERMAL METRIC <sup>(1)</sup>		OPA388-Q1	UNIT
		DBV (SOT-23)	
		5 PINS	
$R_{\theta JA}$	Junction-to-ambient thermal resistance	145.7	°C/W
$R_{\theta JC(top)}$	Junction-to-case (top) thermal resistance	94.8	°C/W
$R_{\theta JB}$	Junction-to-board thermal resistance	43.4	°C/W
$\Psi_{JT}$	Junction-to-top characterization parameter	24.7	°C/W
$\Psi_{JB}$	Junction-to-board characterization parameter	43.1	°C/W
$R_{\theta JC(bot)}$	Junction-to-case (bottom) thermal resistance	N/A	°C/W

(1) For more information about traditional and new thermal metrics, see the [Semiconductor and IC Package Thermal Metrics](#) application report.

## 6.5 Thermal Information: OPA2388-Q1

THERMAL METRIC <sup>(1)</sup>		OPA2388-Q1	UNIT
		DGK (VSSOP)	
		8 PINS	
$R_{\theta JA}$	Junction-to-ambient thermal resistance	165	°C/W
$R_{\theta JC(top)}$	Junction-to-case (top) thermal resistance	53	°C/W
$R_{\theta JB}$	Junction-to-board thermal resistance	87	°C/W
$\Psi_{JT}$	Junction-to-top characterization parameter	4.9	°C/W
$\Psi_{JB}$	Junction-to-board characterization parameter	85	°C/W
$R_{\theta JC(bot)}$	Junction-to-case (bottom) thermal resistance	N/A	°C/W

(1) For more information about traditional and new thermal metrics, see the [Semiconductor and IC Package Thermal Metrics](#) application report.

## 6.6 Electrical Characteristics

at  $T_A = 25^\circ\text{C}$ ,  $V_{CM} = V_{OUT} = V_S / 2$ ,  $V_S = \pm 1.25\text{ V to } \pm 2.75\text{ V}$  (2.5 V to 5.5 V), and  $R_{LOAD} = 10\text{ k}\Omega$  connected to  $V_S / 2$  (unless otherwise noted)

PARAMETER		TEST CONDITIONS		MIN	TYP	MAX	UNIT
<b>OFFSET VOLTAGE</b>							
$V_{OS}$	Input offset voltage	OPA388-Q1			$\pm 0.25$	$\pm 5$	$\mu\text{V}$
		OPA2388-Q1			$\pm 1.5$	$\pm 5$	
		$T_A = -40^\circ\text{C to } +125^\circ\text{C}$				$\pm 7.5$	
$dV_{OS}/dT$	Input offset voltage drift	$T_A = -40^\circ\text{C to } +125^\circ\text{C}$			$\pm 0.005$	$\pm 0.05$	$\mu\text{V}/^\circ\text{C}$
PSRR	Power-supply rejection ratio	$T_A = -40^\circ\text{C to } +125^\circ\text{C}$			$\pm 0.1$	$\pm 1$	$\mu\text{V/V}$
<b>INPUT BIAS CURRENT</b>							
$I_B$	Input bias current	$R_{IN} = 100\text{ k}\Omega$			$\pm 30$	$\pm 350$	$\text{pA}$
			$T_A = 0^\circ\text{C to } +85^\circ\text{C}$			$\pm 400$	
			$T_A = -40^\circ\text{C to } +125^\circ\text{C}$			$\pm 700$	
$I_{OS}$	Input offset current	$R_{IN} = 100\text{ k}\Omega$				$\pm 700$	$\text{pA}$
			$T_A = 0^\circ\text{C to } +85^\circ\text{C}$			$\pm 800$	
			$T_A = -40^\circ\text{C to } +125^\circ\text{C}$			$\pm 800$	
<b>NOISE</b>							
$E_N$	Input voltage noise	$f = 0.1\text{ Hz to } 10\text{ Hz}$			0.14		$\mu\text{V}_{PP}$
$e_N$	Input voltage noise density	$f = 10\text{ Hz}$			7		$\text{nV}/\sqrt{\text{Hz}}$
		$f = 100\text{ Hz}$			7		
		$f = 1\text{ kHz}$			7		
		$f = 10\text{ kHz}$			7		
$I_N$	Input current noise density	$f = 1\text{ kHz}$			100		$\text{fA}/\sqrt{\text{Hz}}$
<b>INPUT VOLTAGE</b>							
$V_{CM}$	Common-mode voltage range			$(V-) - 0.1$		$(V+) + 0.1$	V
CMRR	Common-mode rejection ratio	$(V-) - 0.1\text{ V} < V_{CM} < (V+) + 0.1\text{ V}$		$V_S = \pm 1.25\text{ V}$	124	138	dB
				$V_S = \pm 2.75\text{ V}$	124	140	
		$(V-) < V_{CM} < (V+) + 0.1\text{ V}$ , $T_A = -40^\circ\text{C to } +125^\circ\text{C}$		$V_S = \pm 1.25\text{ V}$	114	134	
		$(V-) - 0.05\text{ V} < V_{CM} < (V+) + 0.1\text{ V}$ , $T_A = -40^\circ\text{C to } +125^\circ\text{C}$		$V_S = \pm 2.75\text{ V}$	124	140	
<b>INPUT IMPEDANCE</b>							
$Z_{id}$	Differential input impedance				$100 \parallel 2$		$\text{M}\Omega \parallel \text{pF}$
$Z_{ic}$	Common-mode input impedance				$60 \parallel 4.5$		$\text{T}\Omega \parallel \text{pF}$
<b>OPEN-LOOP GAIN</b>							
$A_{OL}$	Open-loop voltage gain	$(V-) + 0.15\text{ V} < V_O < (V+) - 0.15\text{ V}$			126	148	dB
				$T_A = -40^\circ\text{C to } +125^\circ\text{C}$	120	126	
		$(V-) + 0.25\text{ V} < V_O < (V+) - 0.25\text{ V}$ , $R_{LOAD} = 2\text{ k}\Omega$			126	148	
		$(V-) + 0.30\text{ V} < V_O < (V+) - 0.30\text{ V}$ , $R_{LOAD} = 2\text{ k}\Omega$		$T_A = -40^\circ\text{C to } +125^\circ\text{C}$	120	148	

## 6.6 Electrical Characteristics (continued)

at  $T_A = 25^\circ\text{C}$ ,  $V_{CM} = V_{OUT} = V_S / 2$ ,  $V_S = \pm 1.25\text{ V to } \pm 2.75\text{ V}$  (2.5 V to 5.5 V), and  $R_{LOAD} = 10\text{ k}\Omega$  connected to  $V_S / 2$  (unless otherwise noted)

PARAMETER		TEST CONDITIONS		MIN	TYP	MAX	UNIT
<b>FREQUENCY RESPONSE</b>							
GBW	Unity-gain bandwidth				10		MHz
SR	Slew rate	$G = 1$ , 4-V step			5		V/ $\mu\text{s}$
THD+N	Total harmonic distortion + noise	$G = 1$ , $f = 1\text{ kHz}$ , $V_O = 1\text{ V}_{RMS}$			0.0005%		
$t_S$	Settling time	$V_S = \pm 2.5\text{ V}$ , $G = 1$ , 1-V step	To 0.1%		0.75		$\mu\text{s}$
			To 0.01%		2		
$t_{OR}$	Overload recovery time	$V_{IN} \times G = V_S$			10		$\mu\text{s}$
<b>OUTPUT</b>							
$V_O$	Voltage output swing from rail	Positive rail	No load		1	15	mV
			$R_{LOAD} = 2\text{ k}\Omega$		5	20	
		Negative rail	No load		20	50	
			$R_{LOAD} = 2\text{ k}\Omega$		5	15	
			$T_A = -40^\circ\text{C to } +125^\circ\text{C}$ , both rails, $R_{LOAD} = 10\text{ k}\Omega$		10	20	
$T_A = -40^\circ\text{C to } +125^\circ\text{C}$ , both rails, $R_{LOAD} = 10\text{ k}\Omega$		40	60				
				10	25		
$I_{SC}$	Short-circuit current	$V_S = 5.5\text{ V}$			$\pm 60$		mA
		$V_S = 2.5\text{ V}$			$\pm 30$		
$C_{LOAD}$	Capacitive load drive				See <a href="#">6-25</a>		
$Z_O$	Open-loop output impedance	$f = 1\text{ MHz}$ , $I_O = 0\text{ A}$ , see <a href="#">6-24</a>			100		$\Omega$
<b>POWER SUPPLY</b>							
$I_Q$	Quiescent current per amplifier	$V_S = \pm 1.25\text{ V}$ ( $V_S = 2.5\text{ V}$ ), $I_O = 0\text{ A}$			1.7	2.4	mA
			$T_A = -40^\circ\text{C to } +125^\circ\text{C}$		1.7	2.4	
		$V_S = \pm 2.75\text{ V}$ ( $V_S = 5.5\text{ V}$ ), $I_O = 0\text{ A}$			1.9	2.6	
			$T_A = -40^\circ\text{C to } +125^\circ\text{C}$		1.9	2.6	

## 6.7 Typical Characteristics

at  $T_A = 25^\circ\text{C}$ ,  $V_S = \pm 2.5\text{ V}$ ,  $V_{CM} = V_S / 2$ ,  $R_{LOAD} = 10\text{ k}\Omega$  connected to  $V_S / 2$ , and  $C_L = 100\text{ pF}$  (unless otherwise noted)

**表 6-1. Table of Graphs**

DESCRIPTION	FIGURE
Offset Voltage Production Distribution	<a href="#">6-1</a>
Offset Voltage Drift Distribution From $-40^\circ\text{C}$ to $+125^\circ\text{C}$	<a href="#">6-2</a>
Offset Voltage vs Temperature	<a href="#">6-3</a>
Offset Voltage vs Common-Mode Voltage	<a href="#">6-4</a>
Offset Voltage vs Power Supply	<a href="#">6-5</a>
Offset Voltage Long Term Drift	<a href="#">6-6</a>
Open-Loop Gain and Phase vs Frequency	<a href="#">6-7</a>
Closed-Loop Gain and Phase vs Frequency	<a href="#">6-8</a>
Input Bias Current vs Common-Mode Voltage	<a href="#">6-9</a>
Input Bias Current vs Temperature	<a href="#">6-10</a>
Output Voltage Swing vs Output Current (Maximum Supply)	<a href="#">6-11</a>
CMRR and PSRR vs Frequency	<a href="#">6-12</a>
CMRR vs Temperature	<a href="#">6-13</a>
PSRR vs Temperature	<a href="#">6-14</a>
0.1-Hz to 10-Hz Noise	<a href="#">6-15</a>
Input Voltage Noise Spectral Density vs Frequency	<a href="#">6-16</a>
THD+N Ratio vs Frequency	<a href="#">6-17</a>
THD+N vs Output Amplitude	<a href="#">6-18</a>
Spectral Content	<a href="#">6-19</a> , <a href="#">6-20</a>
Quiescent Current vs Supply Voltage	<a href="#">6-21</a>
Quiescent Current vs Temperature	<a href="#">6-22</a>
Open-Loop Gain vs Temperature	<a href="#">6-23</a>
Open-Loop Output Impedance vs Frequency	<a href="#">6-24</a>
Small-Signal Overshoot vs Capacitive Load (10-mV Step)	<a href="#">6-25</a>
No Phase Reversal	<a href="#">6-26</a>
Positive Overload Recovery	<a href="#">6-27</a>
Negative Overload Recovery	<a href="#">6-28</a>
Small-Signal Step Response (10-mV Step)	<a href="#">6-29</a> , <a href="#">6-30</a>
Large-Signal Step Response (4-V Step)	<a href="#">6-31</a> , <a href="#">6-32</a>
Settling Time	<a href="#">6-33</a> , <a href="#">6-34</a>
Short-Circuit Current vs Temperature	<a href="#">6-35</a>
Maximum Output Voltage vs Frequency	<a href="#">6-36</a>
EMIRR vs Frequency	<a href="#">6-37</a>



## 6.7 Typical Characteristics (continued)

at  $T_A = 25^\circ\text{C}$ ,  $V_S = \pm 2.5\text{ V}$ ,  $V_{CM} = V_S / 2$ ,  $R_{LOAD} = 10\text{ k}\Omega$  connected to  $V_S / 2$ , and  $C_L = 100\text{ pF}$  (unless otherwise noted)

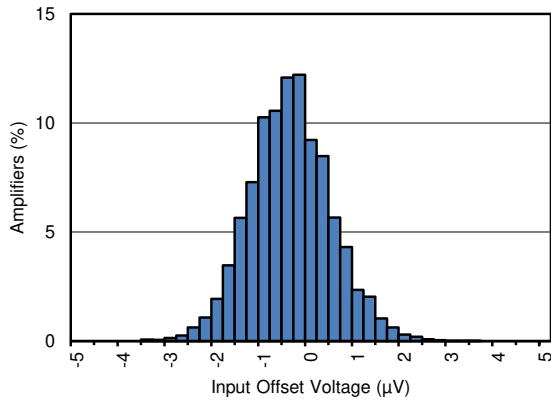

FIG 6-1. Offset Voltage Production Distribution

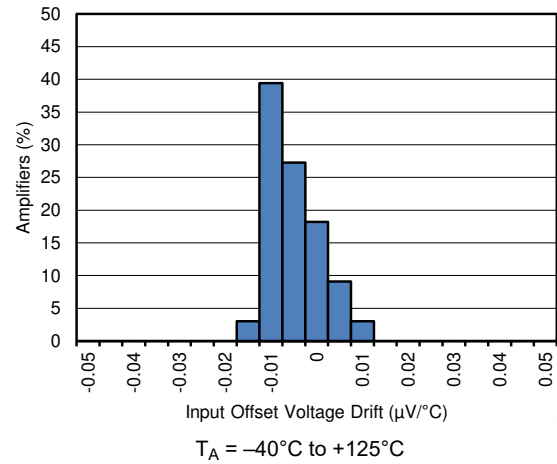

FIG 6-2. Offset Voltage Drift Distribution

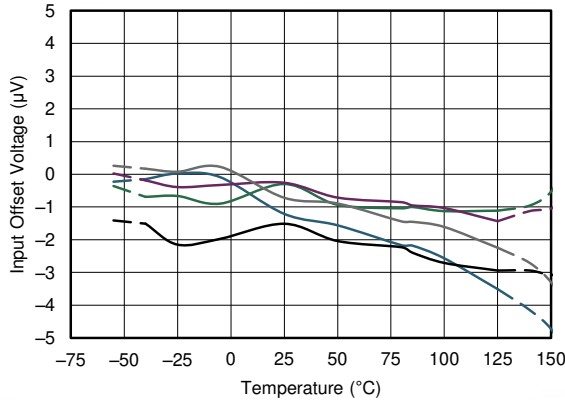

FIG 6-3. Offset Voltage vs Temperature

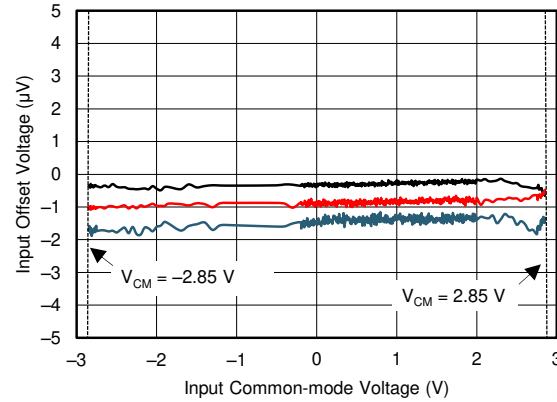

FIG 6-4. Offset Voltage vs Common-Mode Voltage

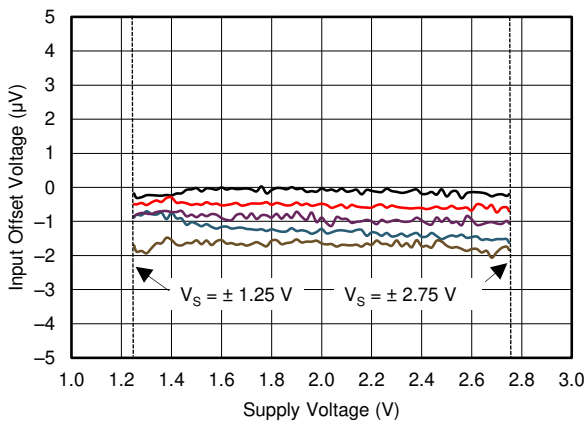

FIG 6-5. Offset Voltage vs Supply Voltage

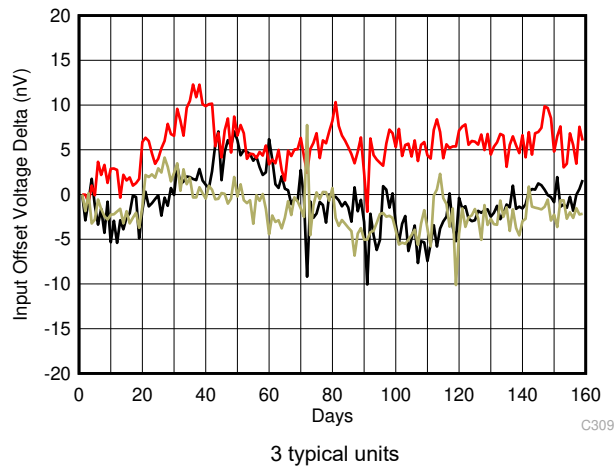

FIG 6-6. Offset Voltage Long Term Drift

## 6.7 Typical Characteristics (continued)

at  $T_A = 25^\circ\text{C}$ ,  $V_S = \pm 2.5\text{ V}$ ,  $V_{CM} = V_S / 2$ ,  $R_{LOAD} = 10\text{ k}\Omega$  connected to  $V_S / 2$ , and  $C_L = 100\text{ pF}$  (unless otherwise noted)

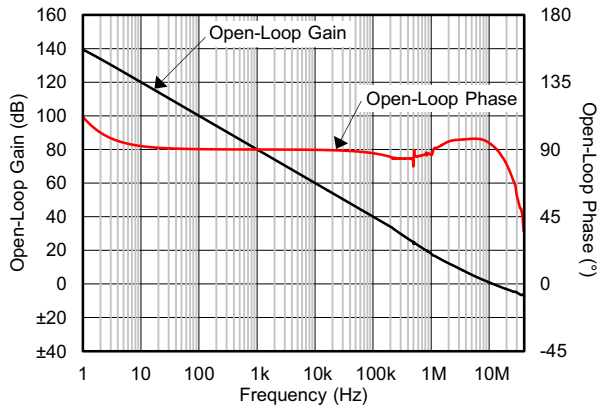

Figure 6-7. Open-Loop Gain and Phase vs Frequency

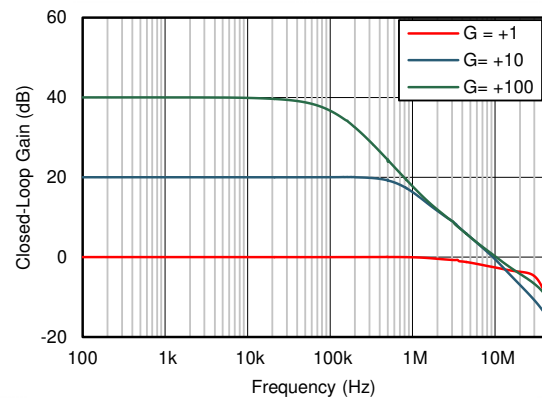

Figure 6-8. Closed-Loop Gain and Phase vs Frequency

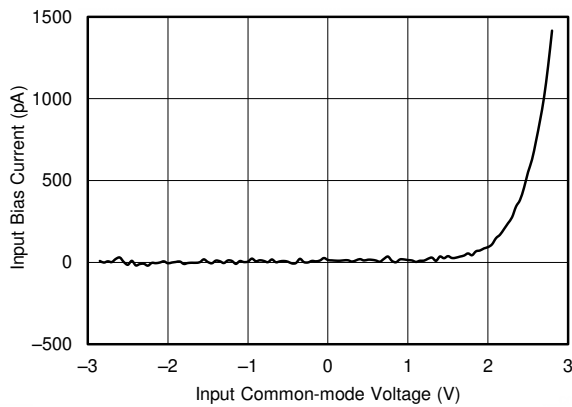

Figure 6-9. Input Bias Current vs Common-Mode Voltage

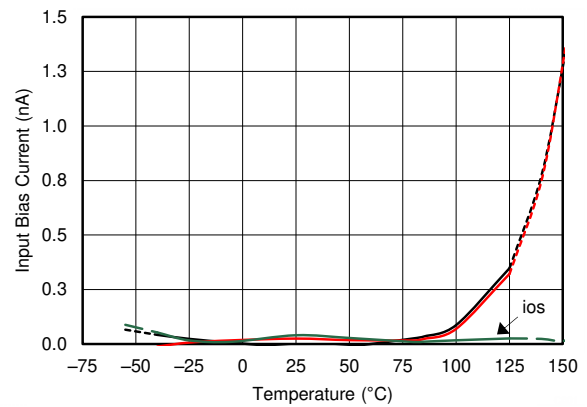

Figure 6-10. Input Bias Current vs Temperature

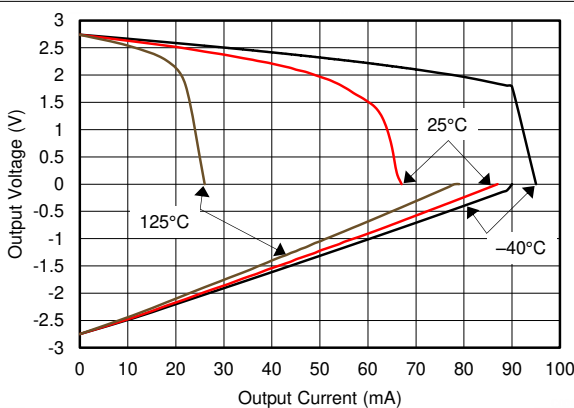

Figure 6-11. Output Voltage Swing vs Output Current (Maximum Supply)

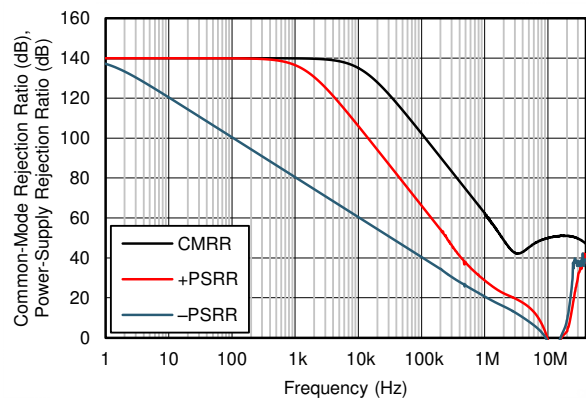
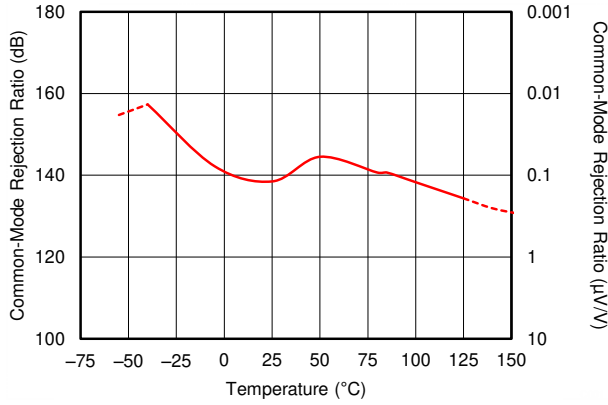

Figure 6-12. CMRR and PSRR vs Frequency

### 6.7 Typical Characteristics (continued)

at  $T_A = 25^\circ\text{C}$ ,  $V_S = \pm 2.5\text{ V}$ ,  $V_{CM} = V_S / 2$ ,  $R_{LOAD} = 10\text{ k}\Omega$  connected to  $V_S / 2$ , and  $C_L = 100\text{ pF}$  (unless otherwise noted)



6-13. CMRR vs Temperature

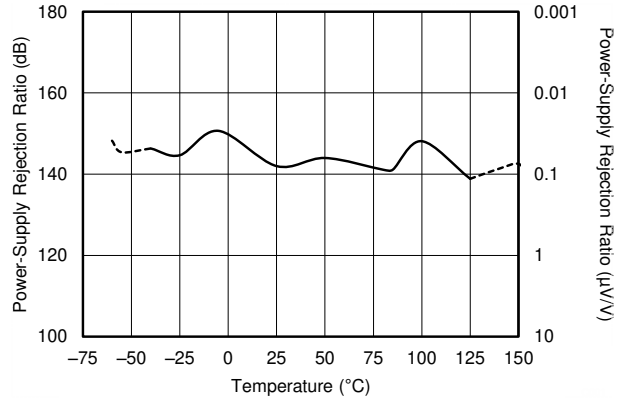

6-14. PSRR vs Temperature

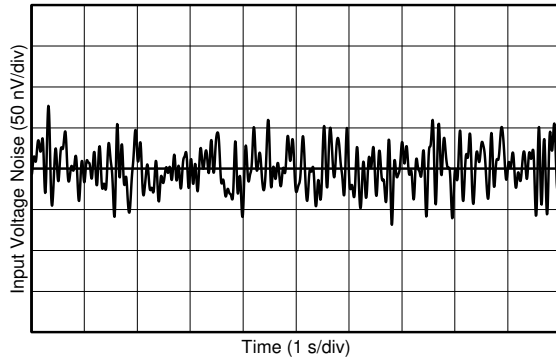

6-15. 0.1-Hz to 10-Hz Noise

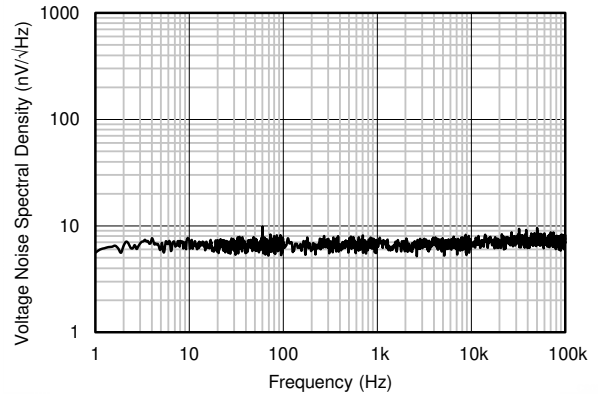

6-16. Input Voltage Noise Spectral Density vs Frequency

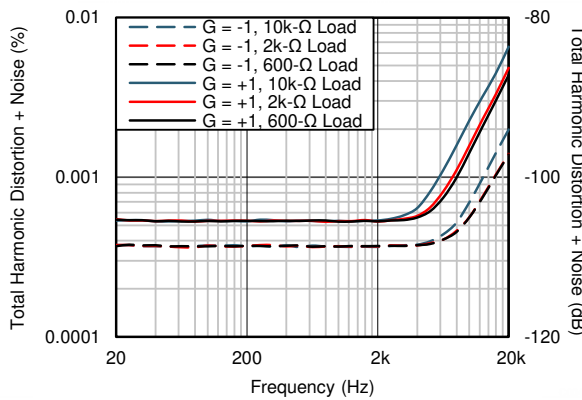

6-17. THD+N Ratio vs Frequency

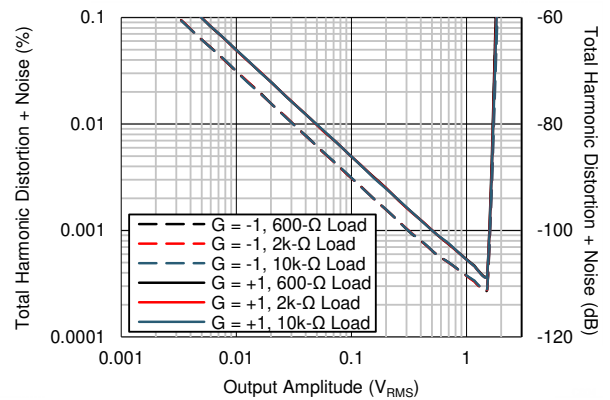

6-18. THD+N vs Output Amplitude

## 6.7 Typical Characteristics (continued)

at  $T_A = 25^\circ\text{C}$ ,  $V_S = \pm 2.5\text{ V}$ ,  $V_{CM} = V_S / 2$ ,  $R_{LOAD} = 10\text{ k}\Omega$  connected to  $V_S / 2$ , and  $C_L = 100\text{ pF}$  (unless otherwise noted)

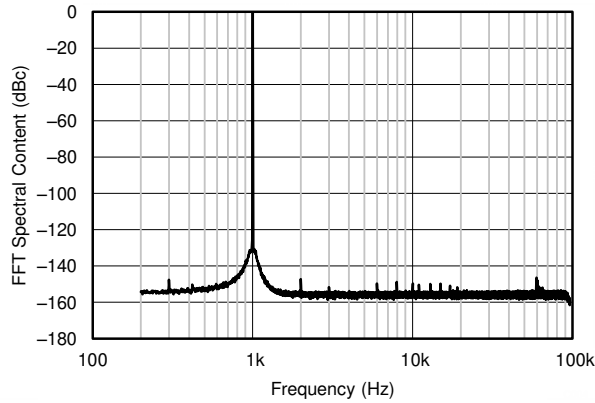

G = +1, f = 1 kHz,  $V_O = 4.5\text{ V}_{PP}$ ,  $R_L = 10\text{ k}\Omega$ , BW = 90 kHz

6-19. Spectral Content (With 10-kΩ Load)

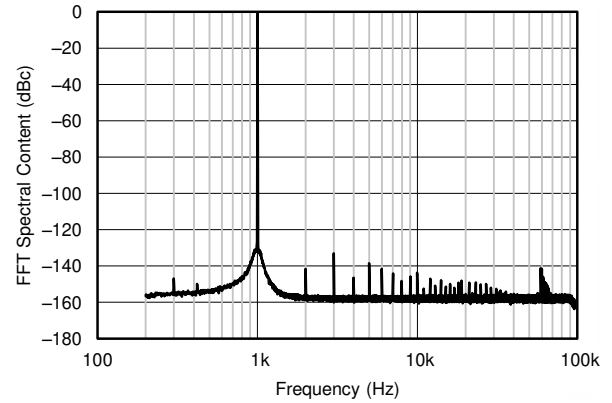

G = +1, f = 1 kHz,  $V_O = 4.5\text{ V}_{PP}$ ,  $R_L = 2\text{ k}\Omega$ , BW = 90 kHz

6-20. Spectral Content (With 2-kΩ Load)

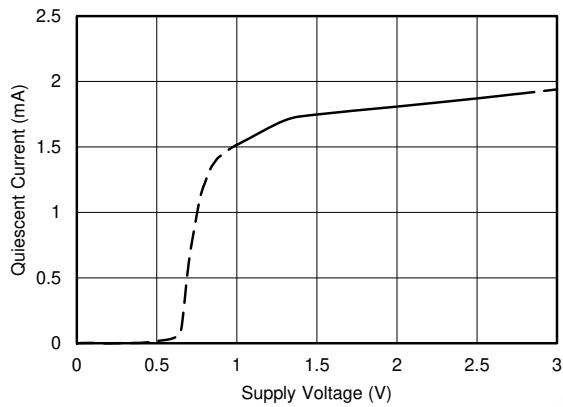

6-21. Quiescent Current vs Supply Voltage

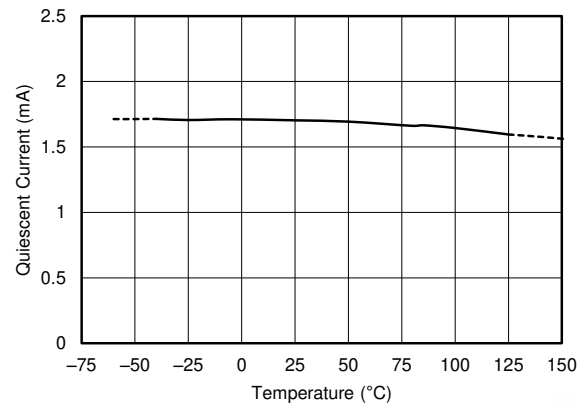

6-22. Quiescent Current vs Temperature

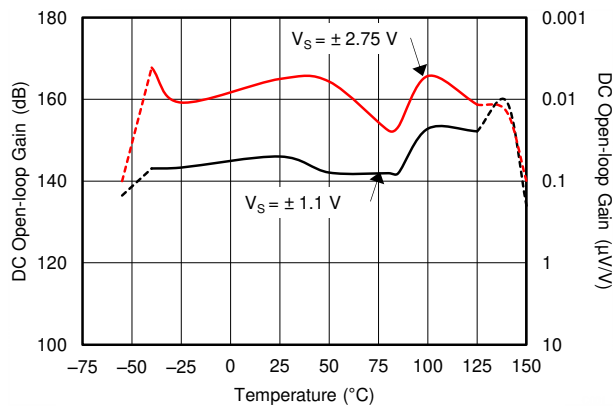

6-23. Open-Loop Gain vs Temperature

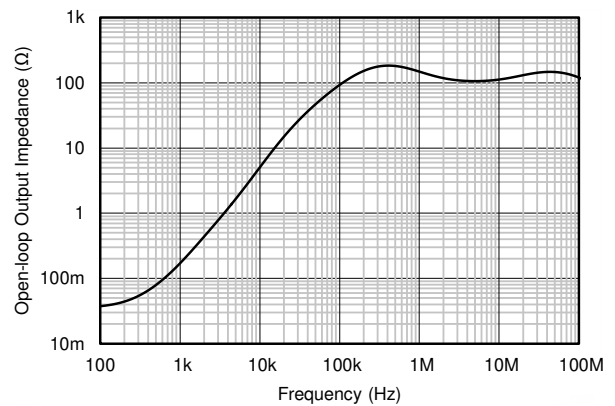

6-24. Open-Loop Output Impedance vs Frequency

## 6.7 Typical Characteristics (continued)

at  $T_A = 25^\circ\text{C}$ ,  $V_S = \pm 2.5\text{ V}$ ,  $V_{CM} = V_S / 2$ ,  $R_{LOAD} = 10\text{ k}\Omega$  connected to  $V_S / 2$ , and  $C_L = 100\text{ pF}$  (unless otherwise noted)

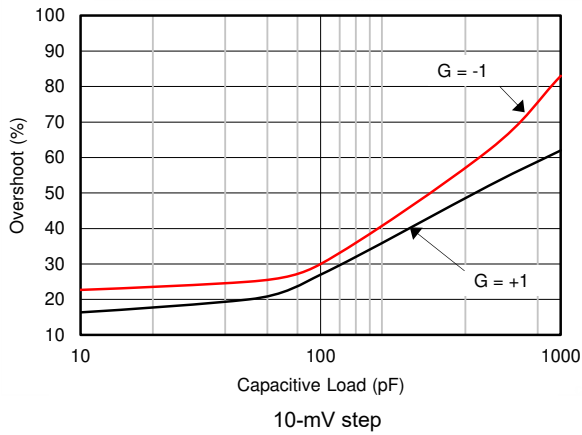

6-25. Small-Signal Overshoot vs Capacitive Load

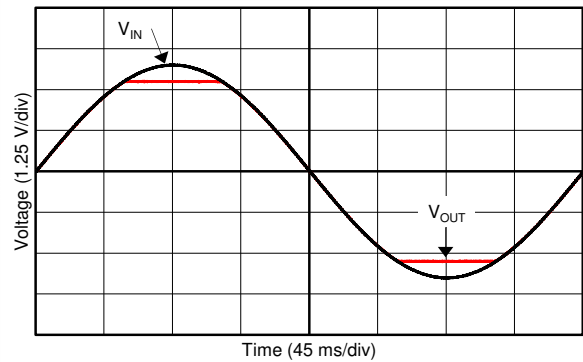

6-26. No Phase Reversal

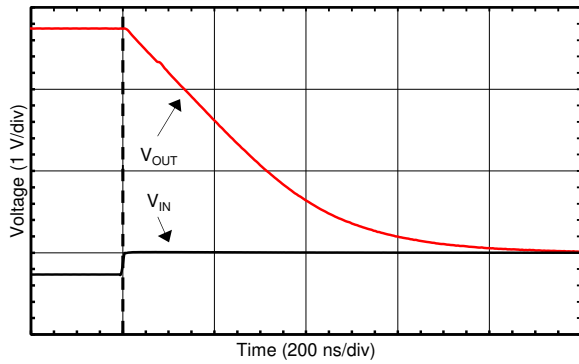

6-27. Positive Overload Recovery

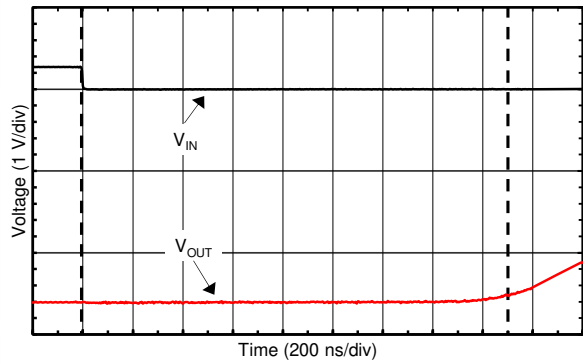

6-28. Negative Overload Recovery

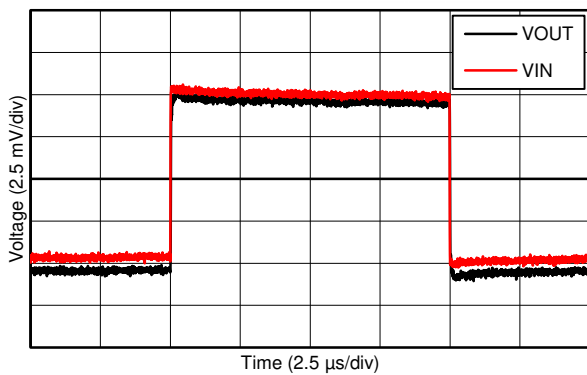

G = +1, 10-mV step

6-29. Small-Signal Step Response

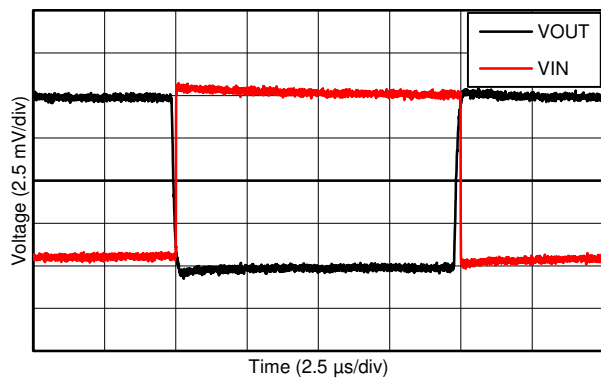

G = -1, 10-mV step

6-30. Small-Signal Step Response

## 6.7 Typical Characteristics (continued)

at  $T_A = 25^\circ\text{C}$ ,  $V_S = \pm 2.5\text{ V}$ ,  $V_{CM} = V_S / 2$ ,  $R_{LOAD} = 10\text{ k}\Omega$  connected to  $V_S / 2$ , and  $C_L = 100\text{ pF}$  (unless otherwise noted)

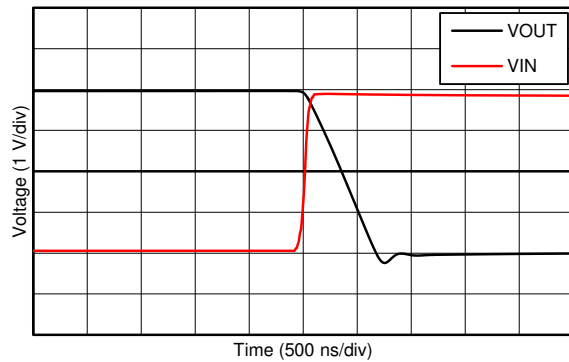

Falling output, 4-V Step

**6-31. Large-Signal Step Response**

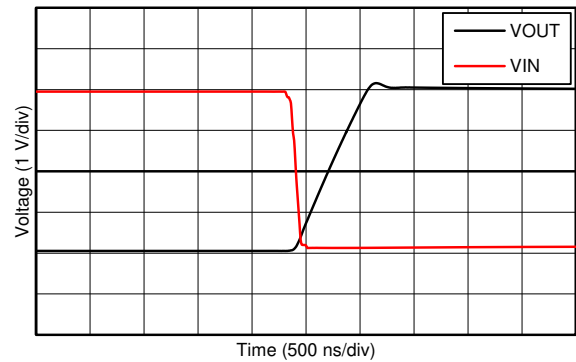

Rising output, 4-V step

**6-32. Large-Signal Step Response**

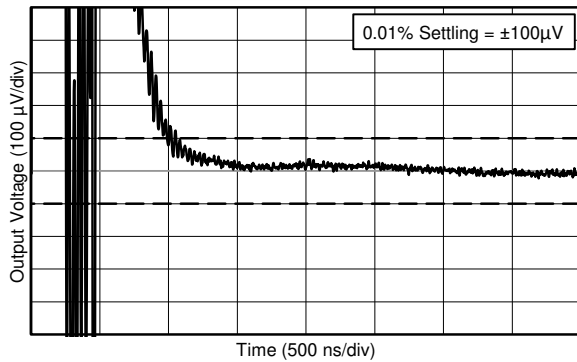

0.01% settling =  $\pm 100\ \mu\text{V}$ , 1-V positive step

**6-33. Settling Time**

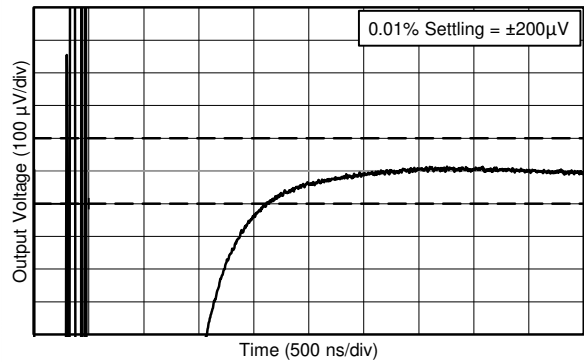

0.01% settling =  $\pm 200\ \mu\text{V}$ , 1-V negative step

**6-34. Settling Time**

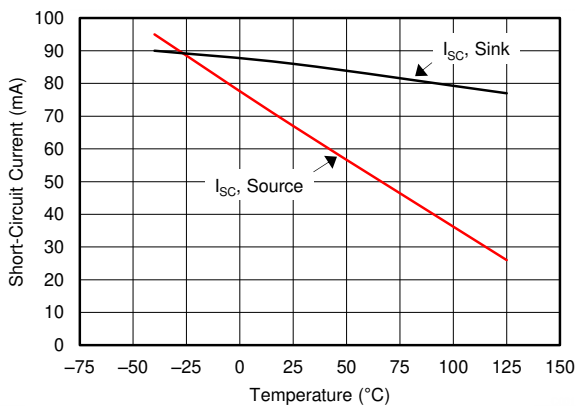

**6-35. Short-Circuit Current vs Temperature**

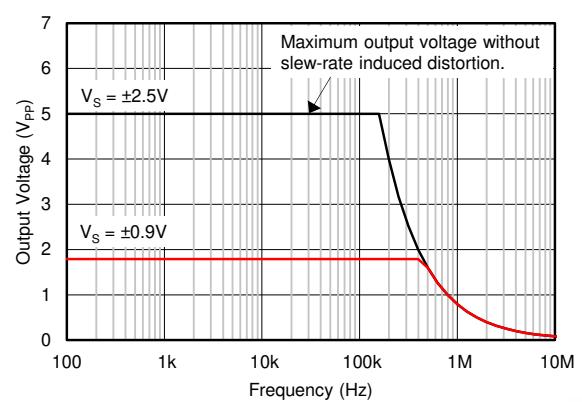

**6-36. Maximum Output Voltage vs Frequency**

## 6.7 Typical Characteristics (continued)

at  $T_A = 25^\circ\text{C}$ ,  $V_S = \pm 2.5\text{ V}$ ,  $V_{CM} = V_S / 2$ ,  $R_{LOAD} = 10\text{ k}\Omega$  connected to  $V_S / 2$ , and  $C_L = 100\text{ pF}$  (unless otherwise noted)

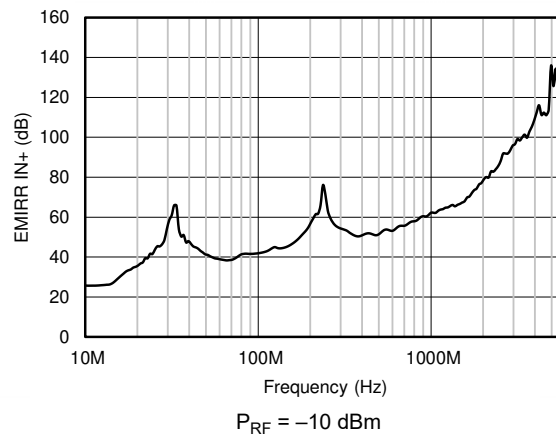

**6-37. EMIRR vs Frequency**

## 7 Detailed Description

### 7.1 Overview

The OPAX388-Q1 zero-drift amplifiers are engineered with the unique combination of a proprietary precision auto-calibration technique and a low-noise, low-ripple, input charge pump. These amplifiers offer ultra-low input offset voltage and drift and achieve excellent input and output dynamic linearity. The OPAX388-Q1 operate from 2.5 V to 5.5 V, are unity-gain stable, and are designed for a wide range of general-purpose and precision applications. The integrated, low-noise charge pump allows true rail-to-rail input common-mode operation without distortion associated with complementary rail-to-rail input topologies (input crossover distortion). The OPAX388-Q1 strengths also include 10-MHz bandwidth,  $7\text{-nV}/\sqrt{\text{Hz}}$  noise spectral density, and no  $1/f$  noise, making these devices an excellent choice for interfacing with sensor modules and buffering high-fidelity digital-to-analog converters (DACs).

### 7.2 Functional Block Diagram

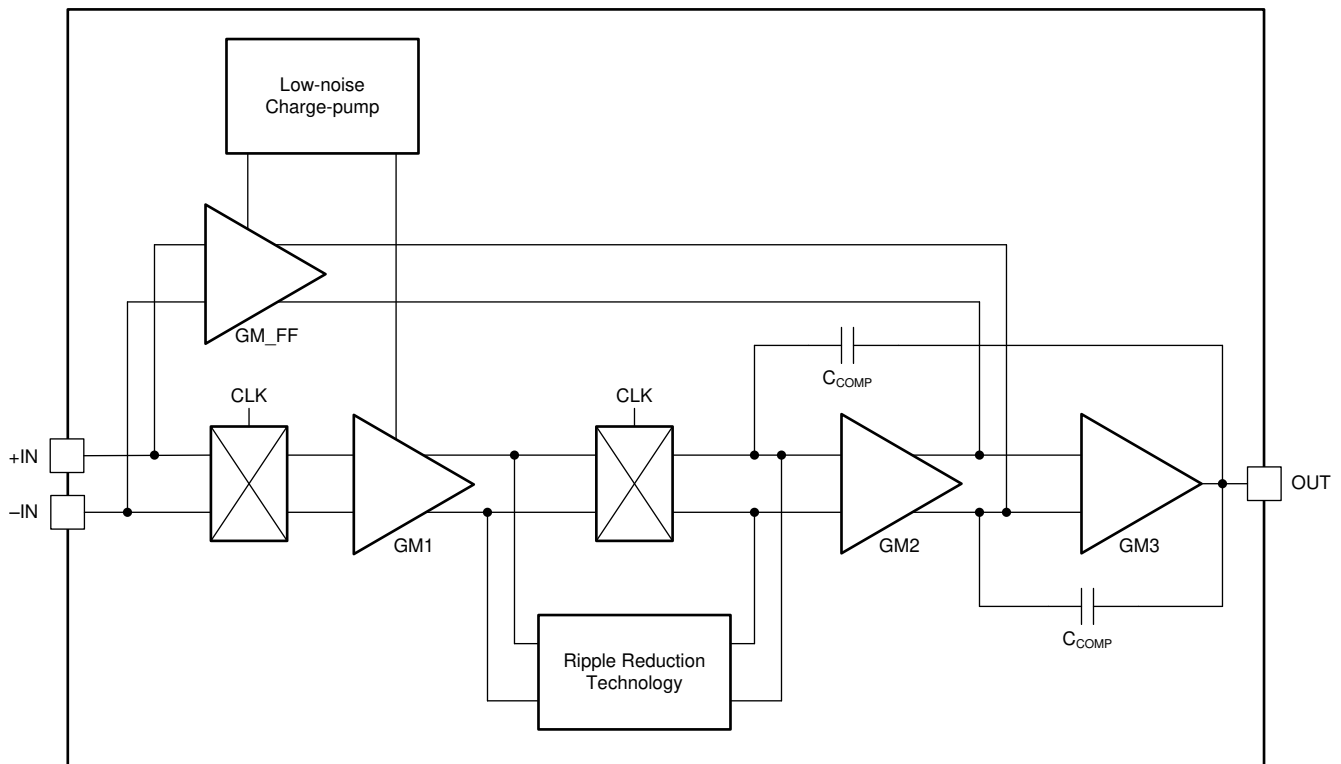

Copyright © 2016, Texas Instruments Incorporated



## 7.3 Feature Description

### 7.3.1 Input Voltage and Zero-Crossover Functionality

The OPAx388-Q1 input common-mode voltage range extends 0.1 V beyond the supply rails. This amplifier family is designed to cover the full range without the troublesome transition region found in some other rail-to-rail amplifiers. Operating a complementary rail-to-rail input amplifier with signals traversing the transition region results in unwanted non-linear behavior and polluted spectral content. [Figure 7-1](#) and [Figure 7-2](#) contrast the performance of a traditional complementary rail-to-rail input stage amplifier with the performance of the zero-crossover OPAx388-Q1. Significant harmonic content and distortion is generated during the differential pair transition (such a transition does not exist in the OPAx388-Q1). Crossover distortion is eliminated through the use of a single differential pair coupled with an internal low-noise charge pump. The OPAx388-Q1 maintain noise, bandwidth, and offset performance throughout the input common-mode range, thus reducing printed circuit board (PCB) and bill of materials (BOM) complexity through the reduction of power-supply rails.

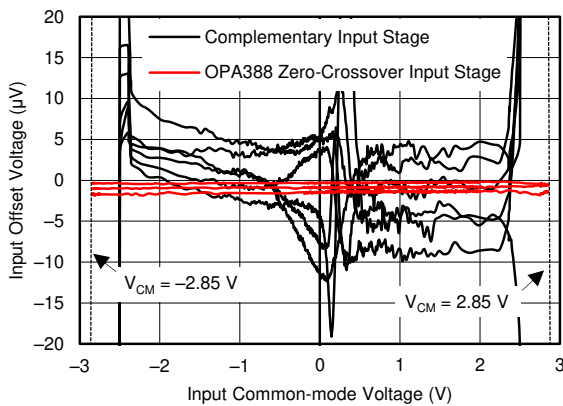

**Figure 7-1. Input Crossover Distortion Nonlinearity**

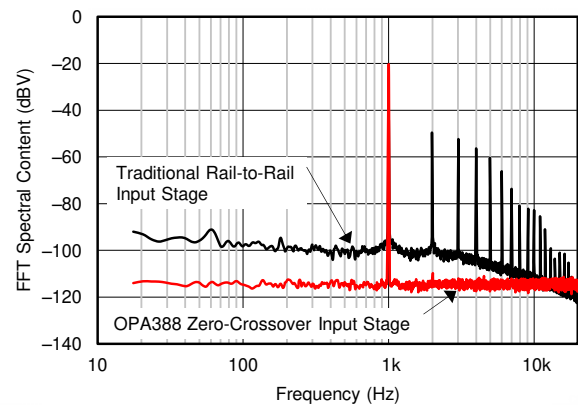

**Figure 7-2. Input Crossover Distortion Spectral Content**

Typically, input bias current is approximately  $\pm 30$  pA. Input voltages exceeding the power supplies, however, can cause excessive current to flow into or out of the input pins. Momentary voltages greater than the power supply can be tolerated if the input current is limited to 10 mA. This limitation is easily accomplished with an input resistor, as shown in [Figure 7-3](#).

Current-limiting resistor required if input voltage exceeds supply rails by  $> 0.3$ V.

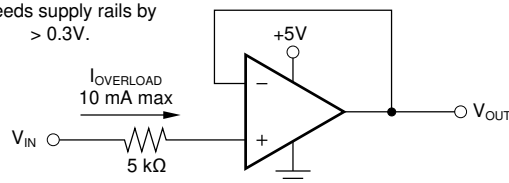

Copyright © 2016, Texas Instruments Incorporated

**Figure 7-3. Input Current Protection**

### 7.3.2 Input Differential Voltage

The typical input bias current of the OPAx388-Q1 during normal operation is approximately 30 pA. In overdriven conditions, the bias current can increase significantly. The most common cause of an overdriven condition occurs when an operational amplifier is outside of the linear range of operation. When the output of the operational amplifier is driven to one of the supply rails, the feedback loop requirements cannot be satisfied and a differential input voltage develops across the input pins. This differential input voltage results in activation of parasitic diodes inside the front-end input chopping switches that combine with 10-k $\Omega$  electromagnetic interference (EMI) filter resistors to create the equivalent circuit shown in [Figure 7-4](#). Notice that the input bias current remains within specification in the linear region.

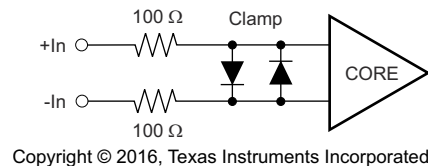

**Figure 7-4. Equivalent Input Circuit**

### 7.3.3 Internal Offset Correction

The OPAx388-Q1 operational amplifiers use an auto-calibration technique with a time-continuous, 200-kHz operational amplifier in the signal path. These amplifiers are zero-corrected every 5  $\mu$ s using a proprietary technique. At power up, the amplifiers require approximately 1 ms to achieve the specified  $V_{OS}$  accuracy. This design has no aliasing or flicker noise.

### 7.3.4 EMI Susceptibility and Input Filtering

Operational amplifiers vary in susceptibility to EMI. If conducted EMI enters the operational amplifier, the dc offset at the amplifier output can shift from its nominal value when EMI is present. This shift is a result of signal rectification associated with the internal semiconductor junctions. Although all operational amplifier pin functions can be affected by EMI, the input pins are likely to be the most susceptible. The OPAx388-Q1 operational amplifier family incorporates an internal input low-pass filter that reduces the amplifier response to EMI. Both common-mode and differential-mode filtering are provided by the input filter. The filter is designed for a cutoff frequency of approximately 20 MHz (–3 dB), with a rolloff of 20 dB per decade.

## 7.4 Device Functional Modes

The OPAx388-Q1 have a single functional mode and are operational when the power-supply voltage is greater than 2.5 V ( $\pm 1.25$  V). The maximum specified power-supply voltage for the OPAx388-Q1 is 5.5 V ( $\pm 2.75$  V).

## 8 Application and Implementation

### Note

以下のアプリケーション情報は、TI の製品仕様に含まれるものではなく、TI ではその正確性または完全性を保証いたしません。個々の目的に対する製品の適合性については、お客様の責任で判断していただくこととなります。お客様は自身の設計実装を検証しテストすることで、システムの機能を確認する必要があります。

### 8.1 Application Information

The OPAx388-Q1 are unity-gain stable, precision operational amplifiers free from unexpected output and phase reversal. The use of proprietary zero-drift circuitry gives the benefit of low input offset voltage over time and temperature, as well as lowering the 1/f noise component. As a result of the high PSRR, these devices work well in applications that run directly from battery power without regulation. The OPAx388-Q1 are optimized for full rail-to-rail input, allowing for low-voltage, single-supply operation or split-supply use. These miniature, high-precision, low-noise amplifiers offer high-impedance inputs that have a common-mode range 100 mV beyond the supplies without input crossover distortion and a rail-to-rail output that swings within 5 mV of the supplies under normal test conditions. The OPAx388-Q1 precision amplifiers are designed for upstream analog signal chain applications in low or high gains, as well as downstream signal chain functions such as DAC buffering.

### 8.2 Typical Application

This single-supply, low-side, bidirectional current-sensing design example detects load currents from  $-1$  A to  $+1$  A. The single-ended output spans from 110 mV to 3.19 V. This design uses the OPA388-Q1 because of the low offset voltage and rail-to-rail input and output. One of the amplifiers is configured as a difference amplifier and the other amplifier provides the reference voltage.

☒ 8-1 shows the circuit drawing.

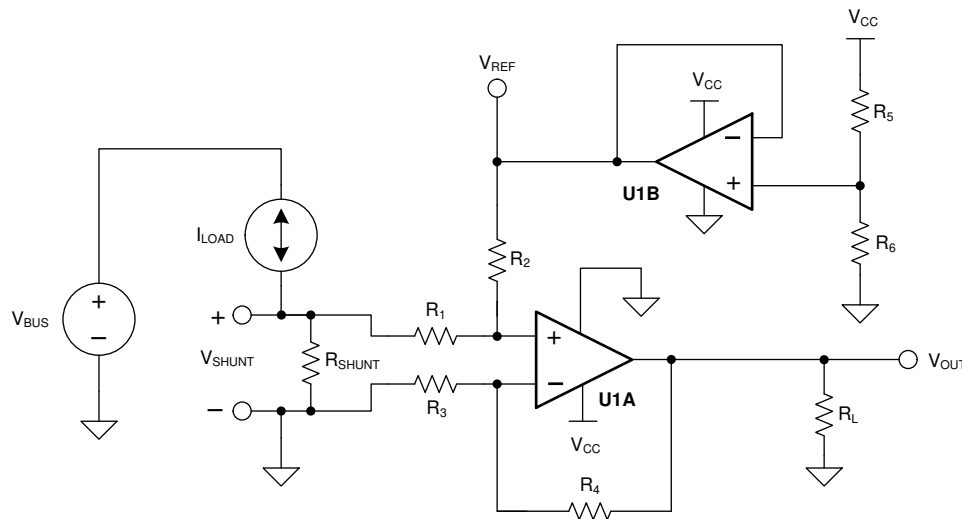

☒ 8-1. Bidirectional Current-Sensing

### 8.2.1 Design Requirements

This solution has the following requirements:

- Supply voltage: 3.3 V
- Input: –1 A to 1 A
- Output: 1.65 V ±1.54 V (110 mV to 3.19 V)

### 8.2.2 Detailed Design Procedure

The load current,  $I_{LOAD}$ , flows through the shunt resistor ( $R_{SHUNT}$ ) to develop the shunt voltage,  $V_{SHUNT}$ . The shunt voltage is then amplified by the difference amplifier consisting of U1A and  $R_1$  through  $R_4$ . The gain of the difference amplifier is set by the ratio of  $R_4$  to  $R_3$ . To minimize errors, set  $R_2 = R_4$  and  $R_1 = R_3$ . The reference voltage,  $V_{REF}$ , is supplied by buffering a resistor divider using U1B. The transfer function is given by [式 1](#).

$$V_{OUT} = V_{SHUNT} \times \text{Gain}_{\text{Diff\_Amp}} + V_{REF} \quad (1)$$

where

- $V_{SHUNT} = I_{LOAD} \times R_{SHUNT}$
- $\text{Gain}_{\text{Diff\_Amp}} = \frac{R_4}{R_3}$
- $V_{REF} = V_{CC} \times \left( \frac{R_6}{R_5 + R_6} \right)$

There are two types of errors in this design: offset and gain. Gain errors are introduced by the tolerance of the shunt resistor and the ratios of  $R_4$  to  $R_3$  and, similarly,  $R_2$  to  $R_1$ . Offset errors are introduced by the voltage divider ( $R_5$  and  $R_6$ ) and how closely the ratio of  $R_4 / R_3$  matches  $R_2 / R_1$ . The latter value affects the CMRR of the difference amplifier, ultimately translating to an offset error.

The value of  $V_{SHUNT}$  is the ground potential for the system load because  $V_{SHUNT}$  is a low-side measurement. Therefore, a maximum value must be placed on  $V_{SHUNT}$ . In this design, the maximum value for  $V_{SHUNT}$  is set to 100 mV. [Equation 2](#) calculates the maximum value of the shunt resistor given a maximum shunt voltage of 100 mV and maximum load current of 1 A.

$$R_{SHUNT(\text{Max})} = \frac{V_{SHUNT(\text{Max})}}{I_{LOAD(\text{Max})}} = \frac{100 \text{ mV}}{1 \text{ A}} = 100 \text{ m}\Omega \quad (2)$$

The tolerance of  $R_{SHUNT}$  is directly proportional to cost. For this design, a shunt resistor with a tolerance of 0.5% was selected. If greater accuracy is required, select a 0.1% resistor or better.

The load current is bidirectional; therefore, the shunt voltage range is –100 mV to 100 mV. This voltage is divided down by  $R_1$  and  $R_2$  before reaching the operational amplifier, U1A. Make sure that the voltage present at the noninverting node of U1A is within the common-mode range of the device. Therefore, use an operational amplifier, such as the OPA388-Q1, that has a common-mode range that extends below the negative supply voltage. Finally, to minimize offset error, the OPA388-Q1 has a typical offset voltage of merely ±0.25  $\mu\text{V}$  (±5  $\mu\text{V}$  maximum).

Given a symmetric load current of –1 A to +1 A, the voltage divider resistors ( $R_5$  and  $R_6$ ) must be equal. To be consistent with the shunt resistor, a tolerance of 0.5% was selected. To minimize power consumption, 10-k $\Omega$  resistors are used.

To set the gain of the difference amplifier, the common-mode range and output swing of the OPA388-Q1 must be considered. Equation 3 and Equation 4 depict the typical common-mode range and maximum output swing, respectively, of the OPA388-Q1 given a 3.3-V supply.

$$-100 \text{ mV} < V_{\text{CM}} < 3.4 \text{ V} \quad (3)$$

$$100 \text{ mV} < V_{\text{OUT}} < 3.2 \text{ V} \quad (4)$$

The gain of the difference amplifier can now be calculated as shown in Equation 5.

$$\text{Gain}_{\text{Diff\_Amp}} = \frac{V_{\text{OUT\_Max}} - V_{\text{OUT\_Min}}}{R_{\text{SHUNT}} \times (I_{\text{MAX}} - I_{\text{MIN}})} = \frac{3.2 \text{ V} - 100 \text{ mV}}{100 \text{ m}\Omega \times [1 \text{ A} - (-1 \text{ A})]} = 15.5 \frac{\text{V}}{\text{V}} \quad (5)$$

The resistor value selected for  $R_1$  and  $R_3$  was 1 k $\Omega$ . 15.4 k $\Omega$  was selected for  $R_2$  and  $R_4$  because this number is the nearest standard value. Therefore, the ideal gain of the difference amplifier is 15.4 V/V.

The gain error of the circuit primarily depends on  $R_1$  through  $R_4$ . As a result of this dependence, 0.1% resistors were selected. This configuration reduces the likelihood that the design requires a two-point calibration. A simple one-point calibration, if desired, removes the offset errors introduced by the 0.5% resistors.

### 8.2.3 Application Curve

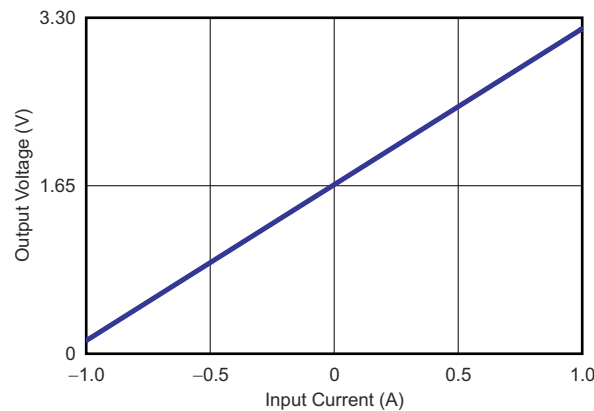

 **8-2. Bidirectional Current-Sensing Circuit Performance: Output Voltage vs Input Current**

## 9 Power Supply Recommendations

The OPAx388-Q1 family of operational amplifiers can be used with single or dual supplies from an operating range of  $V_S = 2.5\text{ V}$  ( $\pm 1.25\text{ V}$ ) up to  $5.5\text{ V}$  ( $\pm 2.75\text{ V}$ ). Key parameters that vary over the supply voltage or temperature range are shown in [セクション 6.7](#).

### CAUTION

Supply voltages greater than 7 V can permanently damage the device (see [セクション 6.1](#)).

## 10 Layout

### 10.1 Layout Guidelines

Pay attention to good layout practice. Keep traces short and, if possible, use a printed-circuit board (PCB) ground plane with surface-mount components placed as close as possible to the device pins. Place a  $0.1\text{-}\mu\text{F}$  capacitor closely across the supply pins. Apply these guidelines throughout the analog circuit to improve performance and provide benefits, such as reducing the electromagnetic interference (EMI) susceptibility.

For lowest offset voltage and precision performance, optimize the circuit layout and mechanical conditions. Avoid temperature gradients that create thermoelectric (Seebeck) effects in the thermocouple junctions formed from connecting dissimilar conductors. These thermally-generated potentials can be made to cancel by making sure these potentials are equal on both input terminals. Other layout and design considerations include:

- Use low thermoelectric-coefficient conditions (avoid dissimilar metals).
- Thermally isolate components from power supplies or other heat sources.
- Shield operational amplifier and input circuitry from air currents, such as cooling fans.

Follow these guidelines to reduce the likelihood of junctions being at different temperatures, which can cause thermoelectric voltage drift of  $0.1\text{ }\mu\text{V}/^\circ\text{C}$  or greater, depending on the materials used.

### 10.2 Layout Example

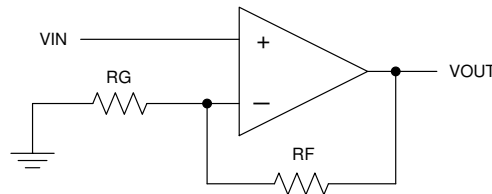

10-1. Schematic Representation

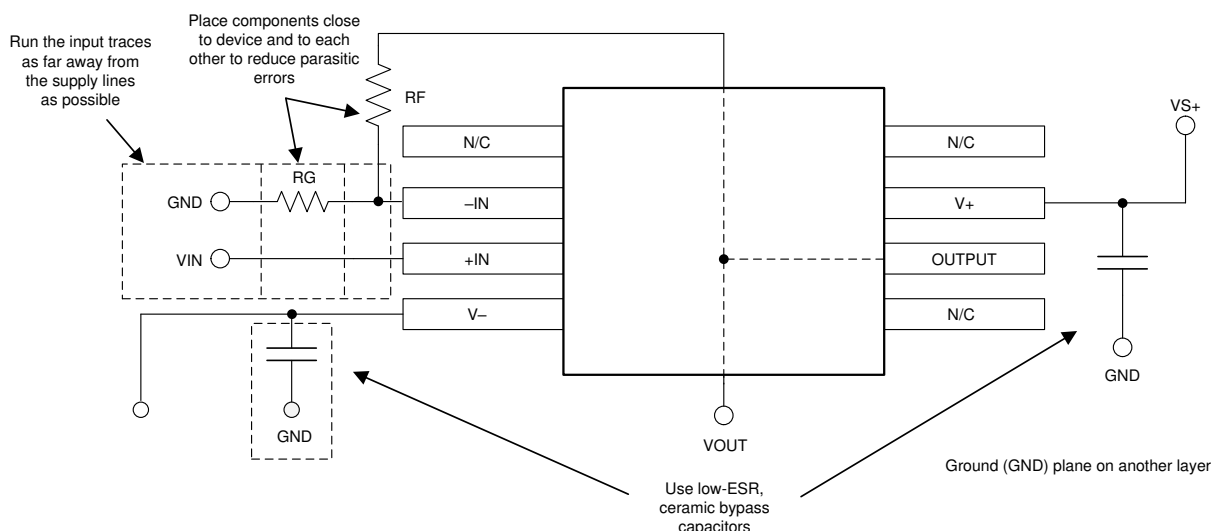

10-2. Layout Example

## 11 Device and Documentation Support

### 11.1 Device Support

#### 11.1.1 Development Support

##### 11.1.1.1 TINA-TI™ Simulation Software (Free Download)

TINA-TI™ simulation software is a simple, powerful, and easy-to-use circuit simulation program based on a SPICE engine. TINA-TI simulation software is a free, fully-functional version of the TINA™ software, preloaded with a library of macromodels, in addition to a range of both passive and active models. TINA-TI simulation software provides all the conventional dc, transient, and frequency domain analysis of SPICE, as well as additional design capabilities.

Available as a [free download](#) from the Analog eLab Design Center, TINA-TI simulation software offers extensive post-processing capability that allows users to format results in a variety of ways. Virtual instruments offer the ability to select input waveforms and probe circuit nodes, voltages, and waveforms, creating a dynamic quick-start tool.

---

#### Note

These files require that either the TINA software or TINA-TI software be installed. Download the free TINA-TI simulation software from the [TINA-TI™ software folder](#).

---

##### 11.1.1.2 PSpice® for TI

PSpice® for TI is a design and simulation environment that helps evaluate performance of analog circuits. Create subsystem designs and prototype solutions before committing to layout and fabrication, reducing development cost and time to market.

##### 11.1.1.3 TI Precision Designs

The OPAx388-Q1 family is featured on TI Precision Designs, available online at [www.ti.com/ww/en/analog/precision-designs/](http://www.ti.com/ww/en/analog/precision-designs/). TI Precision Designs are analog solutions created by TI's precision analog applications experts and offer the theory of operation, component selection, simulation, complete PCB schematic and layout, bill of materials, and measured performance of many useful circuits.

### 11.2 Documentation Support

#### 11.2.1 Related Documentation

For related documentation see the following: Texas Instruments, [Circuit board layout techniques](#)

### 11.3 Receiving Notification of Documentation Updates

To receive notification of documentation updates, navigate to the device product folder on [ti.com](http://ti.com). Click on [Subscribe to updates](#) to register and receive a weekly digest of any product information that has changed. For change details, review the revision history included in any revised document.

### 11.4 サポート・リソース

[TI E2E™ サポート・フォーラム](#)は、エンジニアが検証済みの回答と設計に関するヒントをエキスパートから迅速かつ直接得ることができる場所です。既存の回答を検索したり、独自の質問をしたりすることで、設計に必要な支援を迅速に得ることができます。

リンクされているコンテンツは、該当する貢献者により、現状のまま提供されるものです。これらは TI の仕様を構成するものではなく、必ずしも TI の見解を反映したものではありません。TI の [使用条件](#)を参照してください。

### 11.5 Trademarks

TINA-TI™ and TI E2E™ are trademarks of Texas Instruments.

TINA™ is a trademark of DesignSoft, Inc.

PSpice® is a registered trademark of Cadence Design Systems, Inc.

すべての商標は、それぞれの所有者に帰属します。

## 11.6 Electrostatic Discharge Caution



This integrated circuit can be damaged by ESD. Texas Instruments recommends that all integrated circuits be handled with appropriate precautions. Failure to observe proper handling and installation procedures can cause damage.

ESD damage can range from subtle performance degradation to complete device failure. Precision integrated circuits may be more susceptible to damage because very small parametric changes could cause the device not to meet its published specifications.

## 11.7 Glossary

[TI Glossary](#) This glossary lists and explains terms, acronyms, and definitions.

## 12 Mechanical, Packaging, and Orderable Information

The following pages include mechanical packaging and orderable information. This information is the most current data available for the designated devices. This data is subject to change without notice and revision of this document. For browser-based versions of this data sheet, refer to the left-hand navigation.



**PACKAGING INFORMATION**

Orderable Device	Status (1)	Package Type	Package Drawing	Pins	Package Qty	Eco Plan (2)	Lead finish/ Ball material (6)	MSL Peak Temp (3)	Op Temp (°C)	Device Marking (4/5)	Samples
OPA2388QDGKRQ1	ACTIVE	VSSOP	DGK	8	2500	RoHS & Green	SN	Level-2-260C-1 YEAR	-40 to 125	O28Q	<a href="#">Samples</a>
OPA388QDBVRQ1	ACTIVE	SOT-23	DBV	5	3000	RoHS & Green	NIPDAU	Level-2-260C-1 YEAR	-40 to 125	388Q	<a href="#">Samples</a>

(1) The marketing status values are defined as follows:

**ACTIVE:** Product device recommended for new designs.

**LIFEBUY:** TI has announced that the device will be discontinued, and a lifetime-buy period is in effect.

**NRND:** Not recommended for new designs. Device is in production to support existing customers, but TI does not recommend using this part in a new design.

**PREVIEW:** Device has been announced but is not in production. Samples may or may not be available.

**OBSELETE:** TI has discontinued the production of the device.

(2) **RoHS:** TI defines "RoHS" to mean semiconductor products that are compliant with the current EU RoHS requirements for all 10 RoHS substances, including the requirement that RoHS substance do not exceed 0.1% by weight in homogeneous materials. Where designed to be soldered at high temperatures, "RoHS" products are suitable for use in specified lead-free processes. TI may reference these types of products as "Pb-Free".

**RoHS Exempt:** TI defines "RoHS Exempt" to mean products that contain lead but are compliant with EU RoHS pursuant to a specific EU RoHS exemption.

**Green:** TI defines "Green" to mean the content of Chlorine (Cl) and Bromine (Br) based flame retardants meet JS709B low halogen requirements of <=1000ppm threshold. Antimony trioxide based flame retardants must also meet the <=1000ppm threshold requirement.

(3) MSL, Peak Temp. - The Moisture Sensitivity Level rating according to the JEDEC industry standard classifications, and peak solder temperature.

(4) There may be additional marking, which relates to the logo, the lot trace code information, or the environmental category on the device.

(5) Multiple Device Markings will be inside parentheses. Only one Device Marking contained in parentheses and separated by a "~" will appear on a device. If a line is indented then it is a continuation of the previous line and the two combined represent the entire Device Marking for that device.

(6) Lead finish/Ball material - Orderable Devices may have multiple material finish options. Finish options are separated by a vertical ruled line. Lead finish/Ball material values may wrap to two lines if the finish value exceeds the maximum column width.

**Important Information and Disclaimer:**The information provided on this page represents TI's knowledge and belief as of the date that it is provided. TI bases its knowledge and belief on information provided by third parties, and makes no representation or warranty as to the accuracy of such information. Efforts are underway to better integrate information from third parties. TI has taken and continues to take reasonable steps to provide representative and accurate information but may not have conducted destructive testing or chemical analysis on incoming materials and chemicals. TI and TI suppliers consider certain information to be proprietary, and thus CAS numbers and other limited information may not be available for release.

In no event shall TI's liability arising out of such information exceed the total purchase price of the TI part(s) at issue in this document sold by TI to Customer on an annual basis.

**OTHER QUALIFIED VERSIONS OF OPA2388-Q1, OPA388-Q1 :**

- Catalog : [OPA2388](#), [OPA388](#)

## NOTE: Qualified Version Definitions:

- Catalog - TI's standard catalog product

## TAPE AND REEL INFORMATION



### QUADRANT ASSIGNMENTS FOR PIN 1 ORIENTATION IN TAPE



\*All dimensions are nominal

Device	Package Type	Package Drawing	Pins	SPQ	Reel Diameter (mm)	Reel Width W1 (mm)	A0 (mm)	B0 (mm)	K0 (mm)	P1 (mm)	W (mm)	Pin1 Quadrant
OPA2388QDGKRQ1	VSSOP	DGK	8	2500	330.0	12.4	5.25	3.35	1.25	8.0	12.0	Q1
OPA388QDBVRQ1	SOT-23	DBV	5	3000	180.0	8.4	3.23	3.17	1.37	4.0	8.0	Q3

## TAPE AND REEL BOX DIMENSIONS



\*All dimensions are nominal

Device	Package Type	Package Drawing	Pins	SPQ	Length (mm)	Width (mm)	Height (mm)
OPA2388QDGKRQ1	VSSOP	DGK	8	2500	366.0	364.0	50.0
OPA388QDBVRQ1	SOT-23	DBV	5	3000	213.0	191.0	35.0



# EXAMPLE BOARD LAYOUT

DBV0005A

SOT-23 - 1.45 mm max height

SMALL OUTLINE TRANSISTOR



LAND PATTERN EXAMPLE  
EXPOSED METAL SHOWN  
SCALE:15X

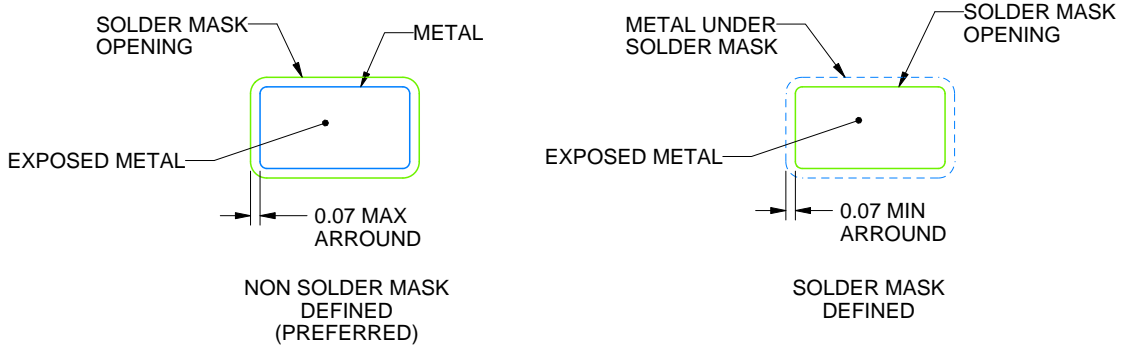

SOLDER MASK DETAILS

4214839/K 08/2024

NOTES: (continued)

- 6. Publication IPC-7351 may have alternate designs.
- 7. Solder mask tolerances between and around signal pads can vary based on board fabrication site.

# EXAMPLE STENCIL DESIGN

DBV0005A

SOT-23 - 1.45 mm max height

SMALL OUTLINE TRANSISTOR



SOLDER PASTE EXAMPLE  
BASED ON 0.125 mm THICK STENCIL  
SCALE:15X

4214839/K 08/2024

NOTES: (continued)

8. Laser cutting apertures with trapezoidal walls and rounded corners may offer better paste release. IPC-7525 may have alternate design recommendations.
9. Board assembly site may have different recommendations for stencil design.

# DGK0008A



# PACKAGE OUTLINE

VSSOP - 1.1 mm max height

SMALL OUTLINE PACKAGE

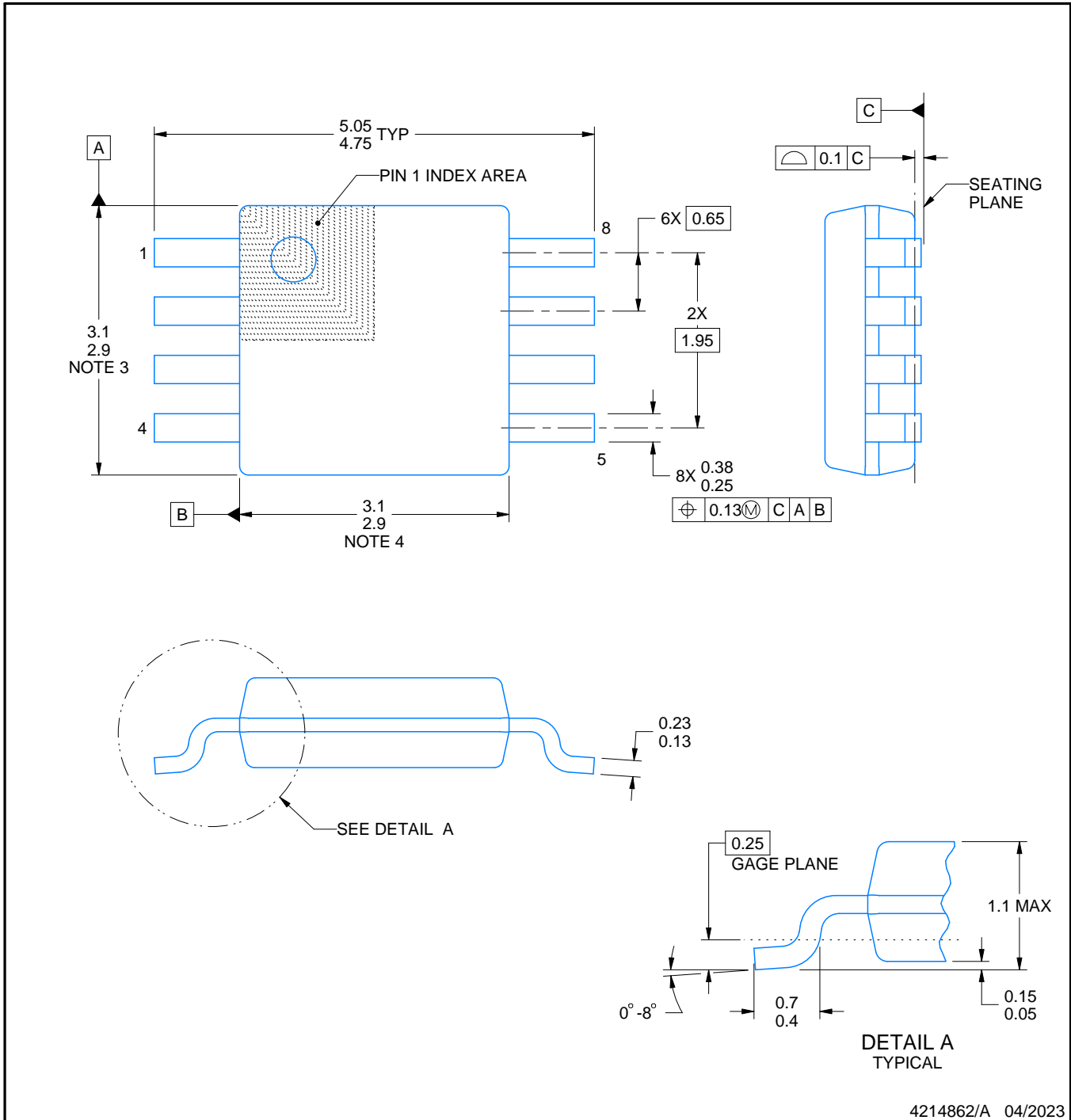

4214862/A 04/2023

**NOTES:**

PowerPAD is a trademark of Texas Instruments.

1. All linear dimensions are in millimeters. Any dimensions in parenthesis are for reference only. Dimensioning and tolerancing per ASME Y14.5M.
2. This drawing is subject to change without notice.
3. This dimension does not include mold flash, protrusions, or gate burrs. Mold flash, protrusions, or gate burrs shall not exceed 0.15 mm per side.
4. This dimension does not include interlead flash. Interlead flash shall not exceed 0.25 mm per side.
5. Reference JEDEC registration MO-187.



# EXAMPLE BOARD LAYOUT

DGK0008A

™ VSSOP - 1.1 mm max height

SMALL OUTLINE PACKAGE



LAND PATTERN EXAMPLE  
EXPOSED METAL SHOWN  
SCALE: 15X



SOLDER MASK DETAILS

4214862/A 04/2023

NOTES: (continued)

6. Publication IPC-7351 may have alternate designs.
7. Solder mask tolerances between and around signal pads can vary based on board fabrication site.
8. Vias are optional depending on application, refer to device data sheet. If any vias are implemented, refer to their locations shown on this view. It is recommended that vias under paste be filled, plugged or tented.
9. Size of metal pad may vary due to creepage requirement.

# EXAMPLE STENCIL DESIGN

DGK0008A

™ VSSOP - 1.1 mm max height

SMALL OUTLINE PACKAGE



SOLDER PASTE EXAMPLE  
SCALE: 15X

4214862/A 04/2023

NOTES: (continued)

11. Laser cutting apertures with trapezoidal walls and rounded corners may offer better paste release. IPC-7525 may have alternate design recommendations.
12. Board assembly site may have different recommendations for stencil design.

## 重要なお知らせと免責事項

TI は、技術データと信頼性データ (データシートを含みます)、設計リソース (リファレンス・デザインを含みます)、アプリケーションや設計に関する各種アドバイス、Web ツール、安全性情報、その他のリソースを、欠陥が存在する可能性のある「現状のまま」提供しており、商品性および特定目的に対する適合性の黙示保証、第三者の知的財産権の非侵害保証を含むいかなる保証も、明示的または黙示的にかかわらず拒否します。

これらのリソースは、TI 製品を使用する設計の経験を積んだ開発者への提供を意図したものです。(1) お客様のアプリケーションに適した TI 製品の選定、(2) お客様のアプリケーションの設計、検証、試験、(3) お客様のアプリケーションに該当する各種規格や、その他のあらゆる安全性、セキュリティ、規制、または他の要件への確実な適合に関する責任を、お客様のみが単独で負うものとし、

上記の各種リソースは、予告なく変更される可能性があります。これらのリソースは、リソースで説明されている TI 製品を使用するアプリケーションの開発の目的でのみ、TI はその使用をお客様に許諾します。これらのリソースに関して、他の目的で複製することや掲載することは禁止されています。TI や第三者の知的財産権のライセンスが付与されている訳ではありません。お客様は、これらのリソースを自身で使用した結果発生するあらゆる申し立て、損害、費用、損失、責任について、TI およびその代理人を完全に補償するものとし、TI は一切の責任を拒否します。

TI の製品は、[TI の販売条件](#)、または [ti.com](#) やかかる TI 製品の関連資料などのいずれかを通じて提供する適用可能な条項の下で提供されています。TI がこれらのリソースを提供することは、適用される TI の保証または他の保証の放棄の拡大や変更を意味するものではありません。

お客様がいかなる追加条項または代替条項を提案した場合でも、TI はそれらに異議を唱え、拒否します。

郵送先住所 : Texas Instruments, Post Office Box 655303, Dallas, Texas 75265  
Copyright © 2024, Texas Instruments Incorporated