

LMZ10500 最大入力電圧 5.5V の 650mA Nano モジュール

1 特長

- 出力電流最大 650mA
- 入力電圧範囲: 2.7V ~ 5.5V
- 出力電圧範囲: 0.6V ~ 3.6V
- 最大効率: 95%
- インダクタ内蔵
- 8 ピンの microSiP フットプリント
- 接合部温度範囲: -40°C ~ 125°C
- 可変出力電圧
- 2MHz の固定 PWM スイッチング周波数
- 補償機能を内蔵
- ソフトスタート機能
- 電流制限保護
- サーマル・シャットダウン保護
- 電源オン、電源オフ、およびブラウンアウト状況の入力電圧 UVLO
- 外付け部品はわずか 5 個 - 分圧抵抗と 3 個のセラミック・コンデンサ
- 小型デザイン・サイズ
- 低出力電圧リップル
- 簡単なコンポーネント選択とシンプルな PCB レイアウト
- 高い効率によりシステムの発熱が減少
- WEBENCH® Power Designer により、LMZ10500 を使用するカスタム設計を作成

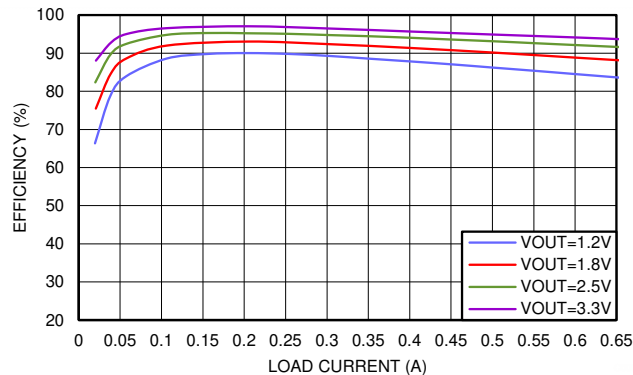

$V_{IN} = 3.6V$ での標準的な効率

2 アプリケーション

- 3.3V および 5V レールからのポイント・オブ・ロード (POL) 変換
- スペースの制約が厳しいアプリケーション
- 低出力ノイズのアプリケーション

3 概要

LMZ10500 Nano モジュールは使いやすい降圧 DC/DC 設計であり、スペースに制約のあるアプリケーションで最大 650mA の負荷を駆動できます。入力コンデンサ、出力コンデンサ、小さな V_{CON} フィルタ・コンデンサ、2 個の抵抗だけで、基本的な動作を実現できます。nano モジュールは 8 ピンの μ SiP フットプリント・パッケージで供給され、インダクタが内蔵されています。内部の電流制限に基づくソフトスタート機能、電流過負荷保護、サーマル・シャットダウン機能も搭載されています。

パッケージ情報

部品番号	パッケージ ⁽¹⁾	パッケージ・サイズ ⁽²⁾
LMZ10500	SIL (μ SiP, 8)	3.00mm × 2.60mm

- 利用可能なすべてのパッケージについては、データシートの末尾にある注文情報を参照してください。
- パッケージ・サイズ (長さ × 幅) は公称値であり、該当する場合はピンも含まれます。

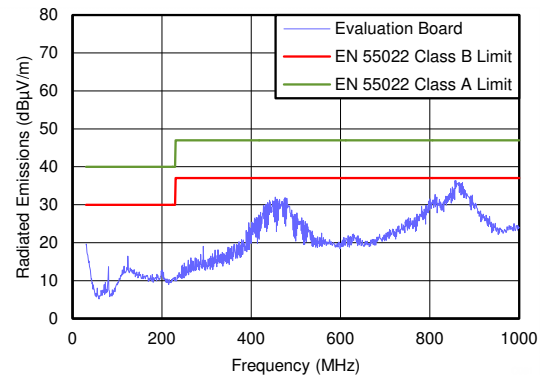

放射 EMI (CISPR22) $V_{IN} = 5V$, $V_{OUT} = 1.8V$, $I_{OUT} = 650mA$



Table of Contents

1 特長.....	1	7.4 Device Functional Modes.....	11
2 アプリケーション.....	1	8 Application and Implementation.....	13
3 概要.....	1	8.1 Application Information.....	13
4 Revision History.....	2	8.2 Typical Application.....	13
5 Pin Configuration and Functions.....	3	8.3 Power Supply Recommendations.....	19
6 Specifications.....	4	8.4 Layout.....	20
6.1 Absolute Maximum Ratings.....	4	9 Device and Documentation Support.....	23
6.2 ESD Ratings.....	4	9.1 Device Support.....	23
6.3 Recommended Operating Conditions.....	4	9.2 Documentation Support.....	23
6.4 Thermal Information.....	4	9.3 ドキュメントの更新通知を受け取る方法.....	23
6.5 Electrical Characteristics.....	5	9.4 サポート・リソース.....	23
6.6 System Characteristics.....	6	9.5 Trademarks.....	23
6.7 Typical Characteristics.....	7	9.6 静電気放電に関する注意事項.....	23
7 Detailed Description.....	9	9.7 用語集.....	23
7.1 Overview.....	9	10 Mechanical, Packaging, and Orderable	
7.2 Functional Block Diagram.....	9	Information.....	24
7.3 Feature Description.....	9		

4 Revision History

資料番号末尾の英字は改訂を表しています。その改訂履歴は英語版に準じています。

Changes from Revision G (July 2018) to Revision H (October 2023)	Page
• ドキュメント全体にわたって表、図、相互参照の採番方法を更新.....	1
• Updated trademark information.....	23
Changes from Revision F (February 2015) to Revision G (July 2018)	Page
• SEO を考慮した編集上の再ブランディング.....	1
• WEBENCH のリンクを追加.....	1
• Move storage temperature spec to <i>Abs Max</i> table.....	4
• Changed "Handling" to "ESD" Ratings.....	4
• Added セクション 9.1	23
• Changed SIL package drawing to SIL0008G.....	24
Changes from Revision E (September 2014) to Revision F (February 2015)	Page
• Switched 図 8-4 and 図 8-5	14
Changes from Revision D (January 2014) to Revision E (September 2014)	Page
• 「ピン構成および機能」セクション、「取り扱いに関する定格」の表、「機能説明」セクション、「デバイスの機能モード」セクション、「アプリケーションと実装」セクション、「電源に関する推奨事項」セクション、「レイアウト」セクション、「デバイスおよびドキュメントのサポート」セクション、「メカニカル、パッケージ、および注文情報」セクションを追加.....	1

5 Pin Configuration and Functions



図 5-1. SIL Package, 8-Pin μ SIP

表 5-1. Pin Functions

PIN		TYPE ⁽¹⁾	DESCRIPTION
NO.	NAME		
1	EN	I	Enable input. Set this digital input higher than 1.2 V for normal operation. For shutdown, set low. Pin is internally pulled up to VIN and can be left floating for always-on operation.
2	VCON	I	Output voltage control pin. Connect to analog voltage from resistive divider or DAC/controller to set the VOUT voltage. $V_{OUT} = 2.5 \times V_{CON}$. Connect a small (470 pF) capacitor from this pin to SGND to provide noise filtering.
3	FB	I	Feedback of the error amplifier. Connect directly to output capacitor to sense VOUT.
4	SGND	I	Ground for analog and control circuitry. Connect to PGND at a single point.
5	VOUT	O	Output Voltage. Connected to one pin of the integrated inductor. Connect output filter capacitor between VOUT and PGND.
6	PGND	I	Power ground for the power MOSFETs and gate-drive circuitry.
7	VIN	I	Voltage supply input. Connect ceramic capacitor between VIN and PGND as close as possible to these two pins. Typical capacitor values are between 4.7 μ F and 22 μ F.
8	VREF	O	2.35 V voltage reference output. Typically connected to VCON pin through a resistive divider to set the output voltage.
—	PAD	I	The center pad underneath the SIL0008A package is internally tied to SGND. Connect this pad to the ground plane for improved thermal performance.

(1) I = input, O = output

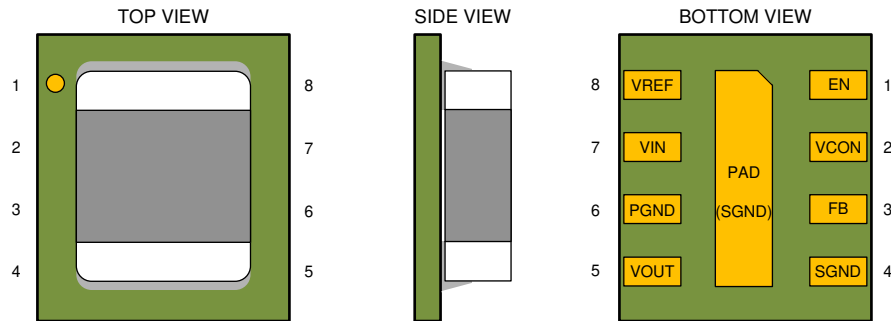
6 Specifications

6.1 Absolute Maximum Ratings

over operating free-air temperature range (unless otherwise noted)^{(1) (2)}

	MIN	MAX	UNIT
VIN, VREF to SGND	−0.2	6	V
PGND to SGND	−0.2	0.2	V
EN, FB, VCON	(SGND − 0.2) to (VIN + 0.2)	6	V
VOUT	(PGND − 0.2) to (VIN + 0.2)	6	V
Junction temperature (T _{J-MAX})	−40	125	°C
Maximum lead temperature		260	°C
Storage temperature, T _{stg}	−65	150	°C

- (1) Absolute Maximum Ratings are limits beyond which damage to the device may occur. セクション 6.3 are conditions under which operation of the device is intended to be functional. For specified specifications and test conditions, see the セクション 6.5.
- (2) If Military/Aerospace specified devices are required, contact the Texas Instruments Sales Office/ Distributors for availability and specifications.

6.2 ESD Ratings

			VALUE	UNIT
V _(ESD)	Electrostatic discharge	Human-body model (HBM), per ANSI/ESDA/JEDEC JS-001 ⁽¹⁾	±1000	V
		Charged-device model (CDM), per JEDEC specification JESD22-C101 ⁽²⁾	±250	

- (1) JEDEC document JEP155 states that 500-V HBM allows safe manufacturing with a standard ESD control process.
- (2) JEDEC document JEP157 states that 250-V CDM allows safe manufacturing with a standard ESD control process.

6.3 Recommended Operating Conditions

over operating free-air temperature range (unless otherwise noted)

	MIN	MAX	UNIT
Input voltage	2.7	5.5	V
Recommended load current	0	650	mA
Junction temperature (T _J)	−40	125	°C

6.4 Thermal Information

THERMAL METRIC ⁽¹⁾			LMZ10500	UNIT
			SIL (μSIP)	
			8 PINS	
R _{θJA}	Junction-to-ambient thermal resistance	SIL0008G Package	45.8	°C/W
R _{θJC(top)}	Junction-to-case (top) thermal resistance		25	°C/W
R _{θJB}	Junction-to-board thermal resistance		9.2	°C/W
Ψ _{JT}	Junction-to-top characterization parameter		1.5	°C/W
Ψ _{JB}	Junction-to-board characterization parameter		9.1	°C/W
R _{θJC(bot)}	Junction-to-case (bottom) thermal resistance		25	°C/W

- (1) For more information about traditional and new thermal metrics, see the [Semiconductor and IC Package Thermal Metrics application report](#).

6.5 Electrical Characteristics

Minimum and maximum limits are specified through test, design, or statistical correlation. Typical values represent the most likely parametric norm at $T_J = 25^\circ\text{C}$, and are provided for reference purposes only. Unless otherwise stated the following conditions apply: $V_{IN} = 3.6\text{ V}$, $V_{EN} = 1.2\text{ V}$, $T_J = 25^\circ\text{C}$ ⁽¹⁾

PARAMETER		TEST CONDITIONS	MIN ⁽¹⁾	TYP ⁽²⁾	MAX ⁽¹⁾	UNIT
SYSTEM PARAMETERS						
$V_{REF} \times \text{GAIN}$	Reference voltage \times VCON to FB Gain	$V_{IN} = V_{EN} = 5.5\text{ V}$, $V_{CON} = 1.44\text{ V}$	5.7575	5.875	5.9925	V
GAIN	VCON to FB Gain	$V_{IN} = 5.5\text{ V}$, $V_{CON} = 1.44\text{ V}$	2.4375	2.5	2.575	V/V
V_{INUVLO}	V_{IN} rising threshold		2.24	2.41	2.64	V
$V_{INUVLO\ HYST}$	V_{IN} UVLO Hysteresis		120	165	200	mV
I_{SHDN}	Shutdown supply current	$V_{IN} = 3.6\text{ V}$, $V_{EN} = 0.5\text{ V}$ ⁽³⁾		11	18	μA
I_q	DC bias current into V_{IN}	$V_{IN} = 5.5\text{ V}$, $V_{CON} = 1.6\text{ V}$, $I_{OUT} = 0\text{ A}$		6.5	9.5	mA
$R_{DROPOUT}$	V_{IN} to V_{OUT} resistance	$I_{OUT} = 200\text{ mA}$		305	575	m Ω
I_{LIM}	DC Output Current Limit	$V_{CON} = 1.72\text{ V}$ ⁽⁴⁾	800	1000		mA
F_{OSC}	Internal oscillator frequency		1.75	2	2.25	MHz
$V_{IH,ENABLE}$	Enable logic HIGH voltage		1.2			V
$V_{IL,ENABLE}$	Enable logic LOW voltage				0.5	V
T_{SD}	Thermal shutdown	Rising Threshold		150		$^\circ\text{C}$
$T_{SD-HYST}$	Thermal shutdown hysteresis			20		$^\circ\text{C}$
D_{MAX}	Maximum duty cycle			100%		
T_{ON-MIN}	Minimum on-time			50		ns
θ_{JA}	Package Thermal Resistance	20-mm x 20-mm board 2 layers, 2 oz copper, 0.5W, no airflow		77		$^\circ\text{C/W}$
		15 mm x 15 mm board 2 layers, 2 oz copper, 0.5W, no airflow		88		
		10 mm x 10 mm board 2 layers, 2 oz copper, 0.5W, no airflow		107		

- (1) Min and Max limits are 100% production tested at 25°C . Limits over the operating temperature range are specified through correlation using Statistical Quality Control (SQC) methods. Limits are used to calculate the Average Outgoing Quality Level (AOQL).
- (2) Typical numbers are at 25°C and represent the most likely parametric norm.
- (3) Shutdown current includes leakage current of the high side PFET.
- (4) Current limit is built-in, fixed, and not adjustable.

6.6 System Characteristics

The following specifications are specified by design providing the component values in [Figure 8-1](#) are used ($C_{IN} = C_{OUT} = 10 \mu\text{F}$, 6.3 V, 0603, TDK C1608X5R0J106K). These parameters are not specified by production testing. Unless otherwise stated the following conditions apply: $T_A = 25^\circ\text{C}$.

	PARAMETER	TEST CONDITIONS	MIN	TYP	MAX	UNIT
$\Delta V_{OUT}/V_{OUT}$	Output Voltage Regulation Over Line Voltage and Load Current	$V_{OUT} = 0.6 \text{ V}$ $\Delta V_{IN} = 2.7 \text{ V to } 4.2 \text{ V}$ $\Delta I_{OUT} = 0 \text{ A to } 650 \text{ mA}$		$\pm 1.23\%$		
$\Delta V_{OUT}/V_{OUT}$	Output Voltage Regulation Over Line Voltage and Load Current	$V_{OUT} = 1.5 \text{ V}$ $\Delta V_{IN} = 2.7 \text{ V to } 5.5 \text{ V}$ $\Delta I_{OUT} = 0 \text{ A to } 650 \text{ mA}$		$\pm 0.56\%$		
$\Delta V_{OUT}/V_{OUT}$	Output Voltage Regulation Over Line Voltage and Load Current	$V_{OUT} = 3.6 \text{ V}$ $\Delta V_{IN} = 4.0 \text{ V to } 5.5 \text{ V}$ $\Delta I_{OUT} = 0 \text{ A to } 650 \text{ mA}$		$\pm 0.24\%$		
$V_{REF} T_{RISE}$	Rise time of reference voltage	EN = Low to High, $V_{IN} = 4.2 \text{ V}$ $V_{OUT} = 2.7 \text{ V}$, $I_{OUT} = 650 \text{ mA}$		10		μs
η	Peak Efficiency	$V_{IN} = 5.0 \text{ V}$, $V_{OUT} = 3.3 \text{ V}$ $I_{OUT} = 200 \text{ mA}$		95%		
	Full Load Efficiency	$V_{IN} = 5.0 \text{ V}$, $V_{OUT} = 3.6 \text{ V}$ $I_{OUT} = 650 \text{ mA}$		93%		
V_{OUT} Ripple	Output voltage ripple	$V_{IN} = 5.0 \text{ V}$, $V_{OUT} = 1.8 \text{ V}$ $I_{OUT} = 650 \text{ mA}$ ⁽¹⁾		8		mV pk-pk
Line Transient	Line transient response	$V_{IN} = 2.7 \text{ V to } 5.5 \text{ V}$, $T_R = T_F = 10 \mu\text{s}$, $V_{OUT} = 1.8 \text{ V}$, $I_{OUT} = 650 \text{ mA}$		25		mV pk-pk
Load Transient	Load transient response	$V_{IN} = 5.0 \text{ V}$ $T_R = T_F = 40 \mu\text{s}$, $V_{OUT} = 1.8 \text{ V}$ $I_{OUT} = 65 \text{ mA to } 650 \text{ mA}$		25		mV pk-pk

(1) Ripple voltage must be measured across C_{OUT} on a well-designed PC board using the suggested capacitors.

6.7 Typical Characteristics

Unless otherwise specified the following conditions apply: $V_{IN} = 3.6\text{ V}$, $T_A = 25^\circ\text{C}$

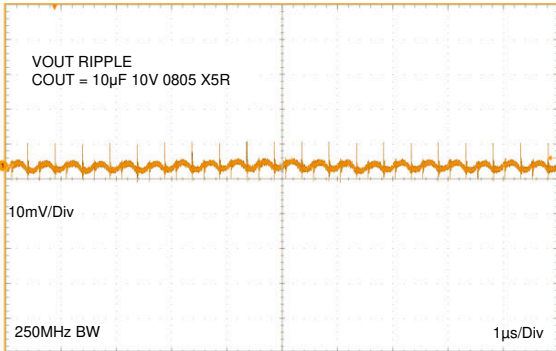

6-1. Output Voltage Ripple $V_{IN} = 5\text{ V}$, $V_{OUT} = 1.8\text{ V}$, $I_{OUT} = 650\text{ mA}$

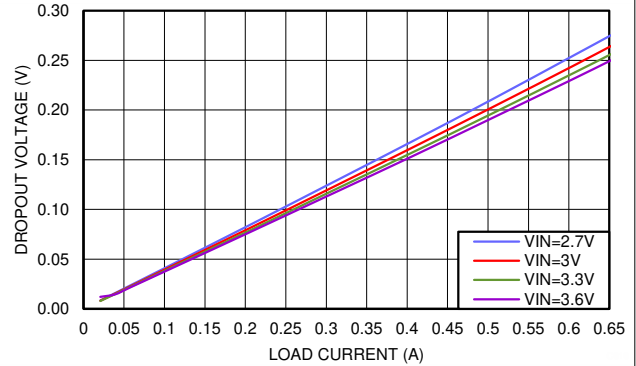

6-2. Dropout Voltage vs Load Current and Input Voltage

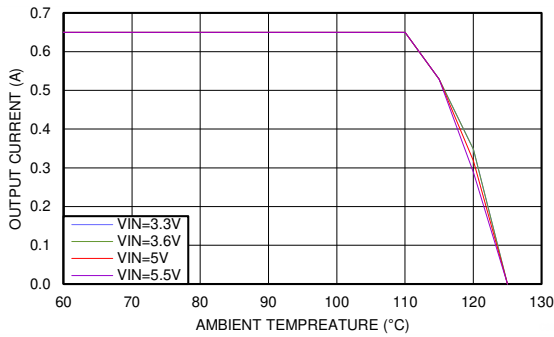

6-3. Thermal Derating $V_{OUT} = 1.2\text{ V}$, $\theta_{JA} = 77^\circ\text{C/W}$

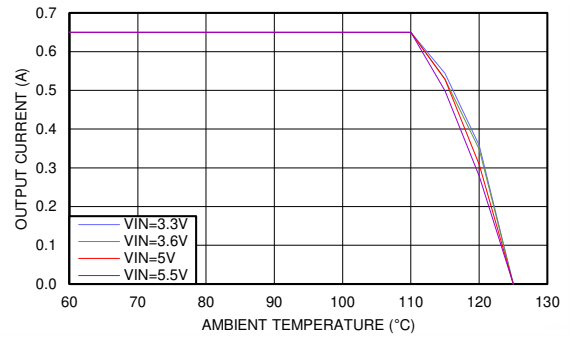

6-4. Thermal Derating $V_{OUT} = 1.8\text{ V}$, $\theta_{JA} = 77^\circ\text{C/W}$

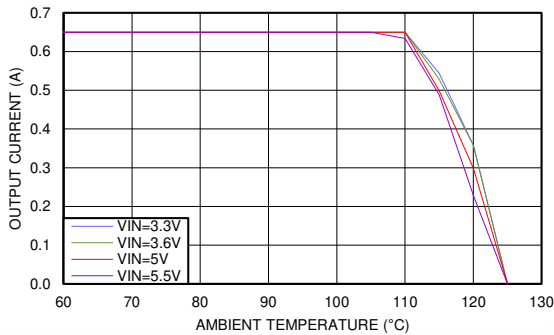

6-5. Thermal Derating $V_{OUT} = 2.5\text{ V}$, $\theta_{JA} = 77^\circ\text{C/W}$

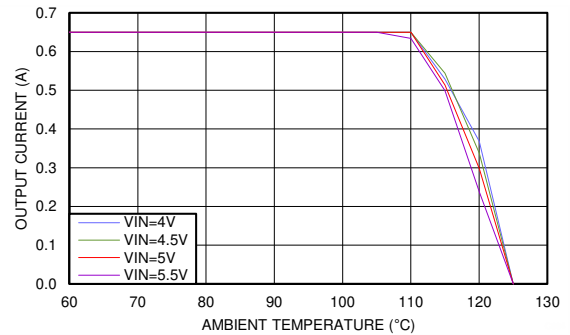

6-6. Thermal Derating $V_{OUT} = 3.3\text{ V}$, $R_{\theta JA} = 77^\circ\text{C/W}$

6.7 Typical Characteristics (continued)

Unless otherwise specified the following conditions apply: $V_{IN} = 3.6\text{ V}$, $T_A = 25^\circ\text{C}$

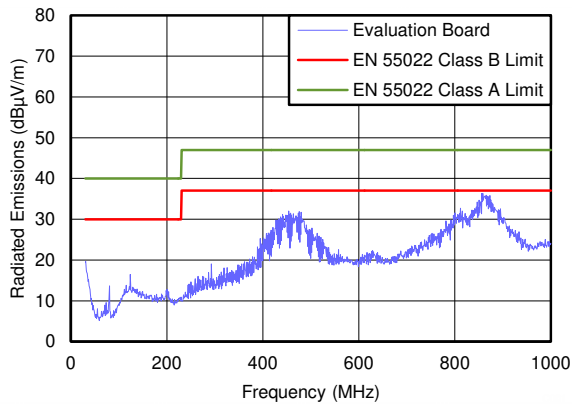

$V_{IN} = 5\text{ V}$ $V_{OUT} = 1.8\text{ V}$ $I_{OUT} = 650\text{ mA}$

6-7. Radiated EMI (CISPR22) Default Evaluation Board BOM

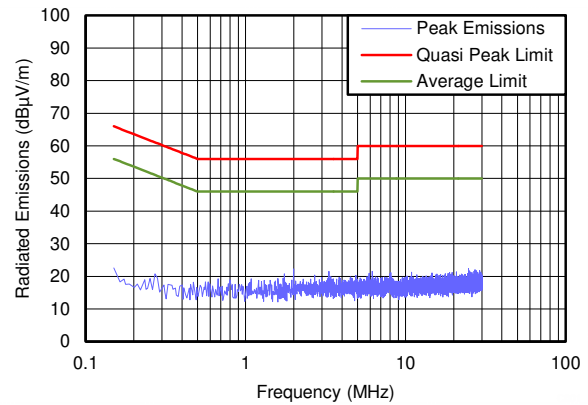

$V_{IN} = 5\text{ V}$ $V_{OUT} = 1.8\text{ V}$ $I_{OUT} = 650\text{ mA}$

6-8. Conducted EMI Default Evaluation Board BOM With Additional 2.2µh 1µf LC Input Filter

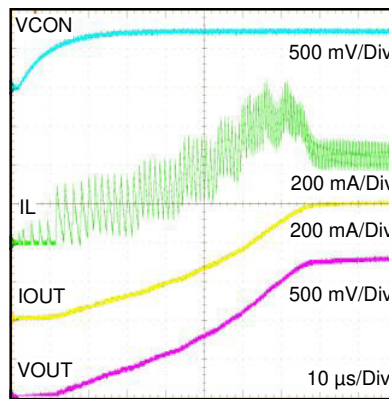

6-9. Startup

7 Detailed Description

7.1 Overview

The LMZ10500 nano module is an easy-to-use step-down DC/DC solution capable of driving up to 650 mA load in space-constrained applications. Only an input capacitor, an output capacitor, a small V_{CON} filter capacitor, and two resistors are required for basic operation. The nano module comes in 8-pin LLP footprint package with an integrated inductor. The LMZ10500 operates in fixed 2-MHz PWM (Pulse Width Modulation) mode, and is designed to deliver power at maximum efficiency. The output voltage is typically set by using a resistive divider between the built-in reference voltage V_{REF} and the control pin V_{CON} . The V_{CON} pin is the positive input to the error amplifier. The output voltage of the LMZ10500 can also be dynamically adjusted between 0.6 V and 3.6 V by driving the V_{CON} pin externally. Internal current limit based soft-start function, current overload protection, and thermal shutdown are also provided.

7.2 Functional Block Diagram

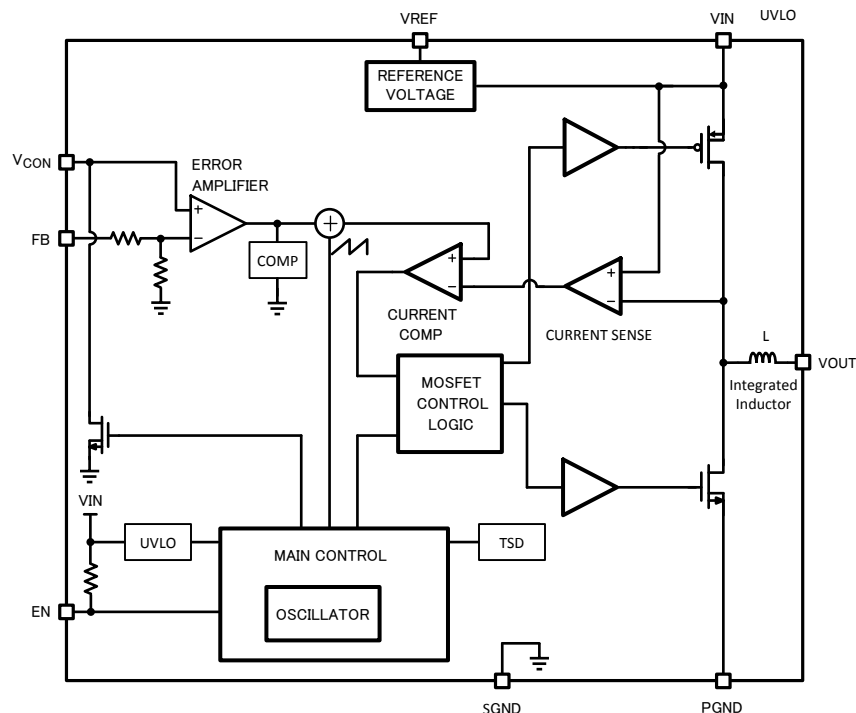

7.3 Feature Description

7.3.1 Current Limit

The LMZ10500 current limit feature protects the module during an overload condition. The circuit employs positive peak current limit in the PFET and negative peak current limit in the NFET switch. The positive peak current through the PFET is limited to 1.2 A (typical). When the current reaches this limit threshold the PFET switch is immediately turned off until the next switching cycle. This behavior continues on a cycle-by-cycle basis until the overload condition is removed from the output. The typical negative peak current limit through the NFET switch is -0.6A (typical).

The ripple of the inductor current depends on the input and output voltages. This means that the DC level of the output current when the peak current limiting occurs will also vary over the line voltage and the output voltage level. Refer to the DC Output Current Limit plots in the [セクション 6.7](#) section for more information.

7.3.2 Start-up Behavior and Soft Start

The LMZ10500 features a current limit based soft-start circuit to prevent large in-rush current and output overshoot as V_{OUT} is ramping up. This is achieved by gradually increasing the PFET current limit threshold to

the final operating value as the output voltage ramps during startup. The maximum allowed current in the inductor is stepped up in a staircase profile for a fixed number of switching periods in each step. Additionally, the switching frequency in the first step is set at 450 kHz and is then increased for each of the following steps until it reaches 2MHz at the final step of current limiting. This current limiting behavior is illustrated in [Figure 7-1](#) and allows for a smooth V_{OUT} ramp up.

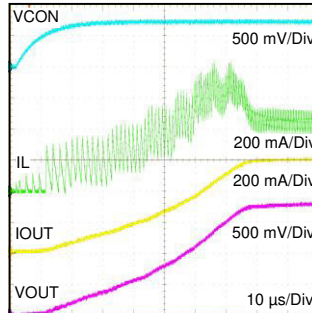

Figure 7-1. Start-Up Behavior of Current Limit Based Soft Start

The soft start rate is also limited by the V_{CON} ramp up rate. The V_{CON} pin is discharged internally through a pull down device before startup occurs. This is done to deplete any residual charge on the V_{CON} filter capacitor and allow the V_{CON} voltage to ramp up from 0V when the part is started. The events that cause V_{CON} discharge are thermal shutdown, UVLO, EN low, or output short circuit detection. The minimum recommended capacitance on V_{CON} is 220 pF and the maximum is 1 nF. The duration of startup current limiting sequence takes approximately 75 μ s. After the sequence is completed, the feedback voltage is monitored for output short circuit events.

7.3.3 Output Short Circuit Protection

In addition to cycle by cycle current limit, the LMZ10500 features a second level of short circuit protection. If the load pulls the output voltage down and the feedback voltage falls to 0.375 V, the output short circuit protection will engage. In this mode the internal PFET switch is turned OFF after the current limit comparator trips and the beginning of the next cycle is inhibited for approximately 230 μ s. This forces the inductor current to ramp down and limits excessive current draw from the input supply when the output of the regulator is shorted. The synchronous rectifier is always OFF in this mode. After 230 μ s of non-switching a new startup sequence is initiated. During this new startup sequence the current limit is gradually stepped up to the nominal value as illustrated in the [Section 7.3.2](#) section. After the startup sequence is completed again, the feedback voltage is monitored for output short circuit. If the short circuit is still persistent after the new startup sequence, switching will be stopped again and there will be another 230 μ s off period. A persistent output short condition results in a hiccup behavior where the LMZ10500 goes through the normal startup sequence, then detects the output short at the end of startup, terminates switching for 230 μ s, and repeats this cycle until the output short is released. This behavior is illustrated in [Figure 7-2](#).

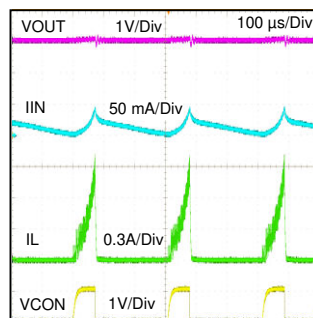

Figure 7-2. Hiccup Behavior With Persistent Output Short Circuit

Because the output current is limited during normal startup by the softstart function, the current charging the output capacitor is also limited. This results in a smooth V_{OUT} ramp up to nominal voltage. However, using excessively large output capacitance or V_{CON} capacitance under normal conditions can prevent the output voltage from reaching 0.375 V at the end of the startup sequence. In such cases the module will maintain the described above hiccup mode and the output voltage will not ramp up to final value. To cause this condition, one can have to use unnecessarily large output capacitance for 650mA load applications. See the [セクション 8.2.2.5](#) section for guidance on maximum capacitances for different output voltage settings.

7.3.4 Thermal Overload Protection

The junction temperature of the LMZ10500 must not be allowed to exceed its maximum operating rating of 125°C. Thermal protection is implemented by an internal thermal shutdown circuit which activates at 150°C (typ). When this temperature is reached, the device enters a low power standby state. In this state switching remains off causing the output voltage to fall. Also, the V_{CON} capacitor is discharged to SGND. When the junction temperature falls back below 130°C (typ) normal startup occurs and V_{OUT} rises smoothly from 0 V. Applications requiring maximum output current can require derating at elevated ambient temperature. See [セクション 6.7](#) for thermal derating plots for various output voltages.

7.4 Device Functional Modes

7.4.1 Circuit Operation

The LMZ10500 is a synchronous Buck power module using a PFET for the high side switch and an NFET for the synchronous rectifier switch. The output voltage is regulated by modulating the PFET switch on-time. The circuit generates a duty-cycle modulated rectangular signal. The rectangular signal is averaged using a low pass filter formed by the integrated inductor and an output capacitor. The output voltage is equal to the average of the duty-cycle modulated rectangular signal. In PWM mode, the switching frequency is constant. The energy per cycle to the load is controlled by modulating the PFET on-time, which controls the peak inductor current. In current mode control architecture, the inductor current is compared with the slope compensated output of the error amplifier. At the rising edge of the clock, the PFET is turned ON, ramping up the inductor current with a slope of $(V_{IN} - V_{OUT}) / L$. The PFET is ON until the current signal equals the error signal. Then the PFET is turned OFF and NFET is turned ON, ramping down the inductor current with a slope of V_{OUT} / L . At the next rising edge of the clock, the cycle repeats. An increase of load pulls the output voltage down, resulting in an increase of the error signal. As the error signal goes up, the peak inductor current is increased, elevating the average inductor current and responding to the heavier load. To specify stability, a slope compensation ramp is subtracted from the error signal and internal loop compensation is provided.

7.4.2 Input Undervoltage Detection

The LMZ10500 implements an under voltage lock out (UVLO) circuit to specify proper operation during startup, shutdown and input supply brownout conditions. The circuit monitors the voltage at the V_{IN} pin to specify that sufficient voltage is present to bias the regulator. If the under voltage threshold is not met, all functions of the controller are disabled and the controller remains in a low power standby state.

7.4.3 Shutdown Mode

To shutdown the LMZ10500, pull the EN pin low (< 0.5 V). In the shutdown mode all internal circuits are turned OFF.

7.4.4 EN Pin Operation

The EN pin is internally pulled up to V_{IN} through a 790 k Ω (typical) resistor. This allows the nano module to be enabled by default when the EN pin is left floating. In such cases V_{IN} will set EN high when V_{IN} reaches 1.2 V. As the input voltage continues to rise, operation will start after V_{IN} exceeds the under-voltage lockout (UVLO) threshold. To set EN high externally, pull it up to 1.2 V or higher. Note that the voltage on EN must remain at less than $V_{IN} + 0.2$ V due to absolute maximum ratings of the device.

7.4.5 Internal Synchronous Rectification

The LMZ10500 uses an internal NFET as a synchronous rectifier to minimize the switch voltage drop and increase efficiency. The NFET is designed to conduct through its intrinsic body diode during the built-in dead time between the PFET on-time and the NFET on-time. This eliminates the need for an external diode. The dead time between the PFET and NFET connection prevents shoot through current from V_{IN} to PGND during the switching transitions.

7.4.6 High Duty Cycle Operation

The LMZ10500 features a transition mode designed to extend the output regulation range to the minimum possible input voltage. As the input voltage decreases closer and closer to V_{OUT} , the off-time of the PFET gets smaller and smaller and the duty cycle eventually must reach 100% to support the output voltage. The input voltage at which the duty cycle reaches 100% is the edge of regulation. When the LMZ10500 input voltage is lowered, such that the off-time of the PFET reduces to less than 35ns, the LMZ10500 doubles the switching period to extend the off-time for that V_{IN} and maintain regulation. If V_{IN} is lowered even more, the off-time of the PFET will reach the 35ns mark again. The LMZ10500 will then reduce the frequency again, achieving less than 100% duty cycle operation and maintaining regulation. As V_{IN} is lowered even more, the LMZ10500 will continue to scale down the frequency, aiming to maintain at least 35ns off time. Eventually, as the input voltage decreases further, 100% duty cycle is reached. This behavior of extending the V_{IN} regulation range is illustrated in [Figure 7-3](#).

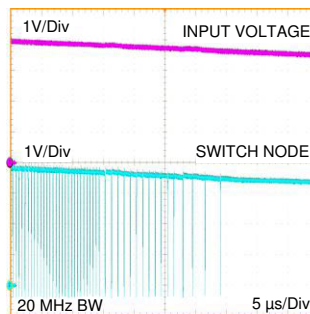

Figure 7-3. High Duty Cycle Operation and Switching Frequency Reduction

8 Application and Implementation

注

以下のアプリケーション情報は、TI の製品仕様に含まれるものではなく、TI ではその正確性または完全性を保証いたしません。個々の目的に対する製品の適合性については、お客様の責任で判断していただくこととなります。お客様は自身の設計実装を検証しテストすることで、システムの機能を確認する必要があります。

8.1 Application Information

This section describes a simple design procedure. Alternatively, WEBENCH® can be used to create and simulate a design using the LMZ10501. The WEBENCH® tool can be accessed from the LMZ10500 product folder at <http://www.ti.com/product/lmz10500>. For designs with typical output voltages (1.2 V, 1.8 V, 2.5 V, 3.3 V), jump to the [セクション 8.2.3](#) section for quick reference designs.

8.2 Typical Application



図 8-1. Typical Application Circuit

8.2.1 Design Requirements

The detailed design procedure is based on the required input and output voltage specifications for the design. The input voltage range of the LMZ10500 is 2.7 V to 5.5 V. The output voltage range is 0.6 V to 3.6 V. The output current capability is 650 mA.

8.2.2 Detailed Design Procedure

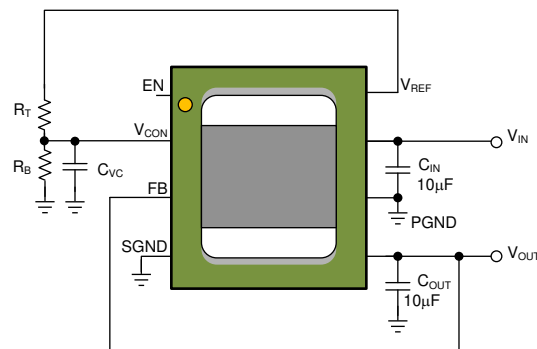
8.2.2.1 Custom Design With WEBENCH® Tools

[Click here](#) to create a custom design using the LMZ10500 device with the WEBENCH® Power Designer.

1. Start by entering the input voltage (V_{IN}), output voltage (V_{OUT}), and output current (I_{OUT}) requirements.
2. Optimize the design for key parameters such as efficiency, footprint, and cost using the optimizer dial.
3. Compare the generated design with other possible solutions from Texas Instruments.

The WEBENCH Power Designer provides a customized schematic along with a list of materials with real-time pricing and component availability.

In most cases, these actions are available:

- Run electrical simulations to see important waveforms and circuit performance
- Run thermal simulations to understand board thermal performance
- Export customized schematic and layout into popular CAD formats
- Print PDF reports for the design, and share the design with colleagues

8.2.2.2 Setting the Output Voltage

The LMZ10500 provides a fixed 2.35-V V_{REF} voltage output. As shown in [Figure 8-1](#) above, a resistive divider formed by R_T and R_B sets the V_{CON} pin voltage level. The V_{OUT} voltage tracks V_{CON} and is governed by the following relationship:

$$V_{OUT} = GAIN \times V_{CON} \quad (1)$$

where

- GAIN is 2.5 V/V from V_{CON} to V_{FB} .

This equation is valid for output voltages between 0.6 V and 3.6 V and corresponds to V_{CON} voltage between 0.24 V and 1.44 V, respectively.

8.2.2.2.1 R_T and R_B Selection for Fixed V_{OUT}

The parameters affecting the output voltage setting are the R_T , R_B , and the product of the V_{REF} voltage \times GAIN. The V_{REF} voltage is typically 2.35 V. Because V_{CON} is derived from V_{REF} through R_T and R_B ,

$$V_{CON} = V_{REF} \times R_B / (R_B + R_T) \quad (2)$$

After substitution,

$$V_{OUT} = V_{REF} \times GAIN \times R_B / (R_B + R_T) \quad (3)$$

$$R_T = (GAIN \times V_{REF} / V_{OUT} - 1) \times R_B \quad (4)$$

The ideal product of $GAIN \times V_{REF} = 5.875$ V.

Choose R_T to be between 80 k Ω and 300 k Ω . Then, R_B can be calculated using [Equation 5](#).

$$R_B = (V_{OUT} / (5.875V - V_{OUT})) \times R_T \quad (5)$$

Note that the resistance of R_T must be ≥ 80 k Ω . This ensures that the V_{REF} output current loading is not exceeded and the reference voltage is maintained. The current loading on V_{REF} must not be greater than 30 μ A.

8.2.2.2.2 Output Voltage Accuracy Optimization

Each nano module is optimized to achieve high V_{OUT} accuracy. [Equation 1](#) shows that, by design, the output voltage is a function of the V_{CON} voltage and the gain from V_{CON} to V_{FB} . The voltage at V_{CON} is derived from V_{REF} . Therefore, as shown in [Equation 3](#), the accuracy of the output voltage is a function of the $V_{REF} \times GAIN$ product as well as the tolerance of the R_T and R_B resistors. The typical $V_{REF} \times GAIN$ product by design is 5.875V. Each nano module's V_{REF} voltage is trimmed so that this product is as close to the ideal 5.875V value as possible, achieving high V_{OUT} accuracy. See [Section 6.5](#) for the $V_{REF} \times GAIN$ product tolerance limits.

8.2.2.3 Dynamic Output Voltage Scaling

The V_{CON} pin on the LMZ10500 can be driven externally by a DAC to scale the output voltage dynamically. The output voltage $V_{OUT} = 2.5$ V/V $\times V_{CON}$. When driving V_{CON} with a source different than V_{REF} place a 1.5 k Ω resistor in series with the V_{CON} pin. Current limiting the external V_{CON} helps to protect this pin and allows the V_{CON} capacitor to be fully discharged to 0 V after fault conditions.

8.2.2.4 Integrated Inductor

The LMZ10500 includes an inductor with over 1.2A DC current rating and soft saturation profile for up to 2 A. This inductor allows for low package height and provides an easy to use, compact solution with reduced EMI.

8.2.2.5 Input and Output Capacitor Selection

The LMZ10500 is designed for use with low ESR multi-layer ceramic capacitors (MLCC) for its input and output filters. Using a 10- μ F 0603 or 0805 with 6.3-V or 10-V rating ceramic input capacitor typically provides sufficient

V_{IN} bypass. Use of multiple 4.7- μF or 2.2- μF capacitors can also be considered. Ceramic capacitors with X5R and X7R temperature characteristics are recommended for both input and output filters. These provide an optimal balance between small size, cost, reliability, and performance for space sensitive applications.

The DC voltage bias characteristics of the capacitors must be considered when selecting the DC voltage rating and case size of these components. The effective capacitance of an MLCC is typically reduced by the DC voltage bias applied across its terminals. For example, a typical 0805 case size X5R 6.3-V 10- μF ceramic capacitor can only have 4.8 μF left in it when a 5.0-V DC bias is applied. Similarly, a typical 0603 case size X5R 6.3-V 10- μF ceramic capacitor can only have 2.4 μF at the same 5.0-V DC. Smaller case size capacitors can have even larger percentage drop in value with DC bias.

The optimum output capacitance value is application dependent. Too small output capacitance can lead to instability due to lower loop phase margin. On the other hand, if the output capacitor is too large, it can prevent the output voltage from reaching the 0.375V required voltage level at the end of the startup sequence. In such cases, the output short circuit protection can be engaged and the nano module will enter a hiccup mode as described in the [セクション 7.3.3](#) section. [表 8-1](#) sets the minimum output capacitance for stability and maximum output capacitance for proper startup for various output voltage settings. Note that the maximum C_{OUT} value in [表 8-1](#) assumes that the filter capacitance on V_{CON} is the maximum recommended value of 1nF and the R_T resistor value is less than 300k Ω . Lower V_{CON} capacitance can extend the maximum C_{OUT} range. There is no great performance benefit in using excessive C_{OUT} values.

表 8-1. Output Capacitance Range

OUTPUT VOLTAGE	MINIMUM C_{OUT}	SUGGESTED C_{OUT}	MAXIMUM C_{OUT}
0.6 V	4.7 μF	10 μF	33 μF
1 V	3.3 μF	10 μF	33 μF
1.2V	3.3 μF	10 μF	33 μF
1.8 V	3.3 μF	10 μF	47 μF
2.5 V	3.3 μF	10 μF	68 μF
3.3V	3.3 μF	10 μF	68 μF

Use of multiple 4.7- μF or 2.2- μF output capacitors can be considered for reduced effective ESR and smaller output voltage ripple. In addition to the main output capacitor, small 0.1- μF – 0.01- μF parallel capacitors can be used to reduce high frequency noise.

8.2.3 Application Curves

8.2.3.1 $V_{OUT} = 1.2\text{ V}$

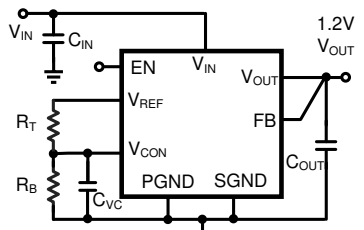

C_{IN}	10 μF	$\geq 6.3\text{V}$	0805	X7R or X5R
C_{OUT}	10 μF	$\geq 6.3\text{V}$	0805	X7R or X5R
C_{VC}	470 pF	$\geq 6.3\text{V}$	0603	X7R or X5R
R_T	243 k Ω	1%	0603	
R_B	63.4 k Ω	1%	0603	

8-2. Schematic $V_{OUT} = 1.2\text{ V}$

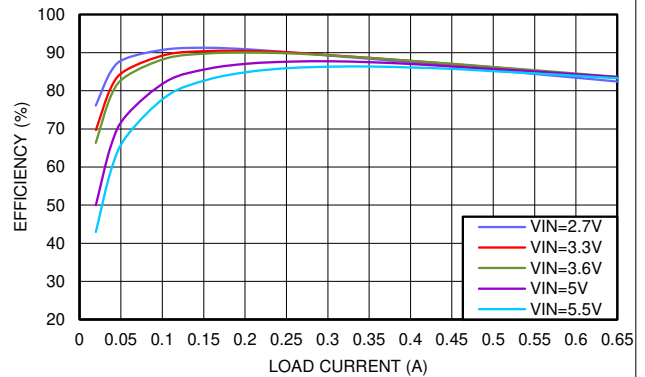

8-3. Efficiency $V_{OUT} = 1.2\text{ V}$

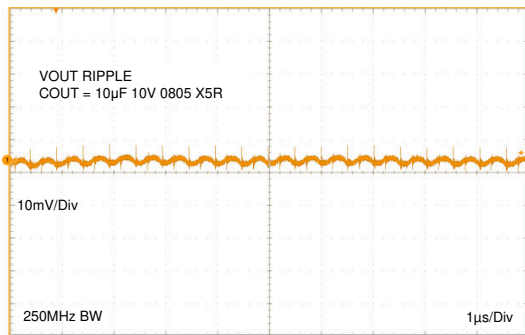

8-4. Output Ripple $V_{OUT} = 1.2\text{ V}$

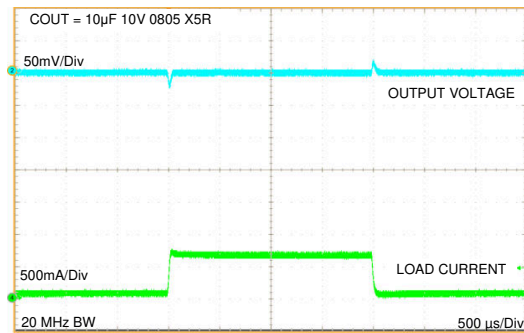

8-5. Load Transient $V_{OUT} = 1.2\text{ V}$

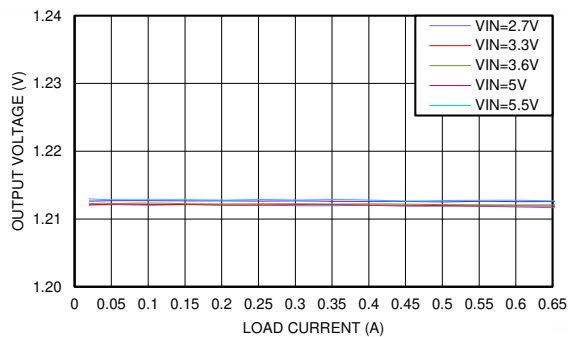

8-6. Line and Load Regulation $V_{OUT} = 1.2\text{ V}$

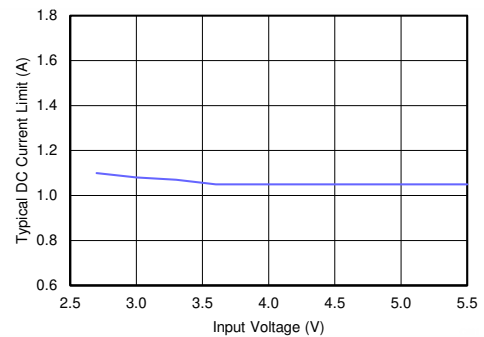

8-7. DC Current Limit $V_{OUT} = 1.2\text{ V}$

8.2.3.2 $V_{OUT} = 1.8\text{ V}$

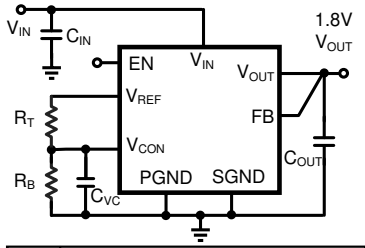

C_{IN}	10 μF	$\geq 6.3\text{V}$	0805	X7R or X5R
C_{OUT}	10 μF	$\geq 6.3\text{V}$	0805	X7R or X5R
C_{VC}	470 pF	$\geq 6.3\text{V}$	0603	X7R or X5R
R_T	187 k Ω	1%	0603	
R_B	82.5 k Ω	1%	0603	

8-8. Schematic $V_{OUT} = 1.8\text{ V}$

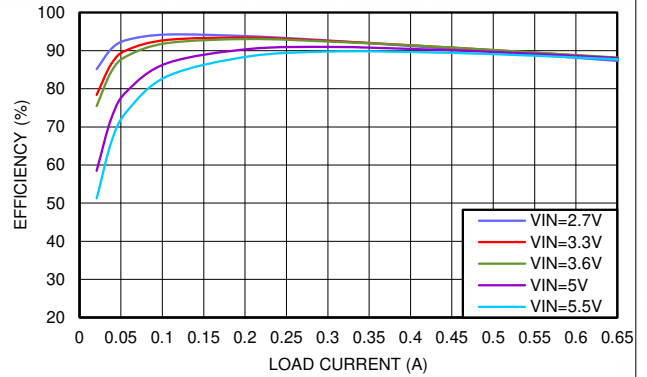

8-9. Efficiency $V_{OUT} = 1.8\text{ V}$

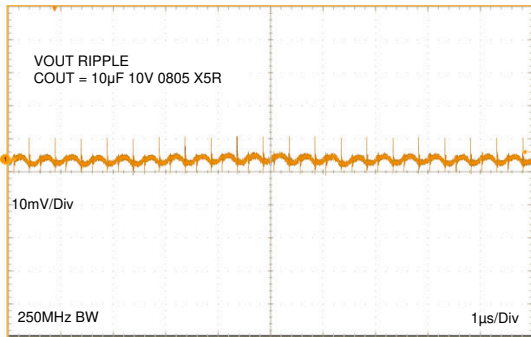

8-10. Output Ripple $V_{OUT} = 1.8\text{ V}$

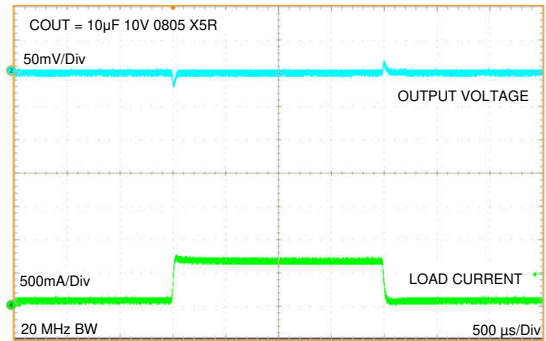

8-11. Load Transient $V_{OUT} = 1.8\text{ V}$

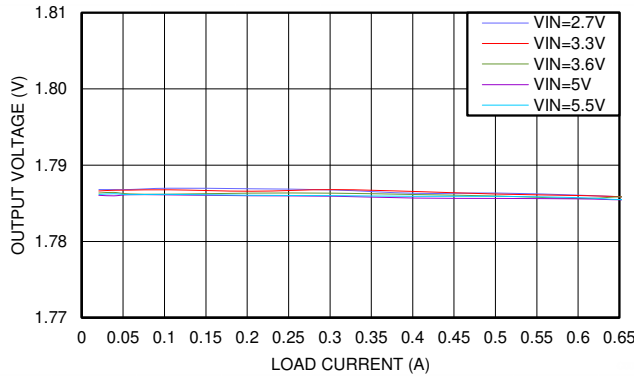

8-12. Line and Load Regulation $V_{OUT} = 1.8\text{ V}$

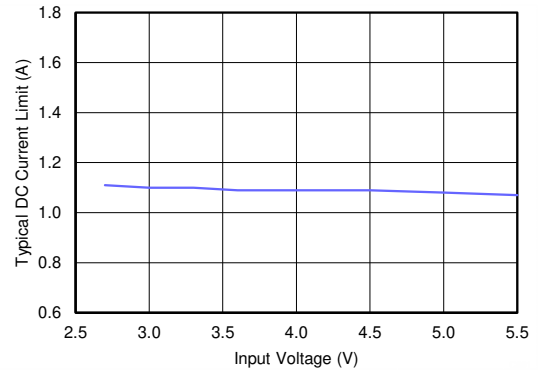

8-13. DC Current Limit $V_{OUT} = 1.8\text{ V}$

8.2.3.3 $V_{OUT} = 2.5\text{ V}$



图 8-14. Schematic $V_{OUT} = 2.5\text{ V}$



图 8-15. Efficiency $V_{OUT} = 2.5\text{ V}$

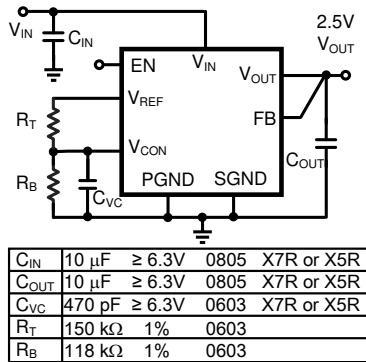

图 8-16. Output Ripple $V_{OUT} = 2.5\text{ V}$

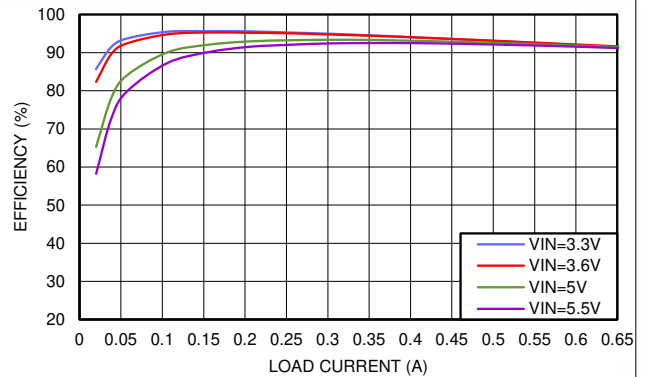

图 8-17. Load Transient $V_{OUT} = 2.5\text{ V}$

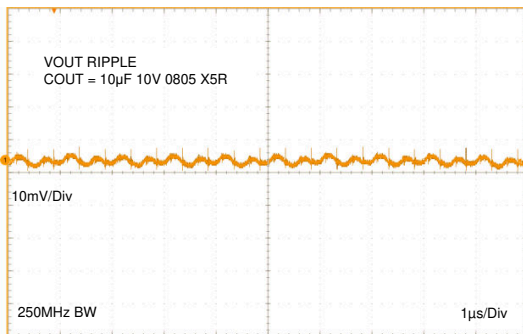

图 8-18. Line and Load Regulation $V_{OUT} = 2.5\text{ V}$

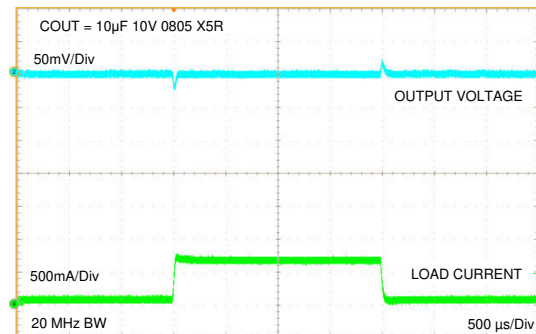

图 8-19. DC Current Limit $V_{OUT} = 2.5\text{ V}$

8.2.3.4 $V_{OUT} = 3.3\text{ V}$

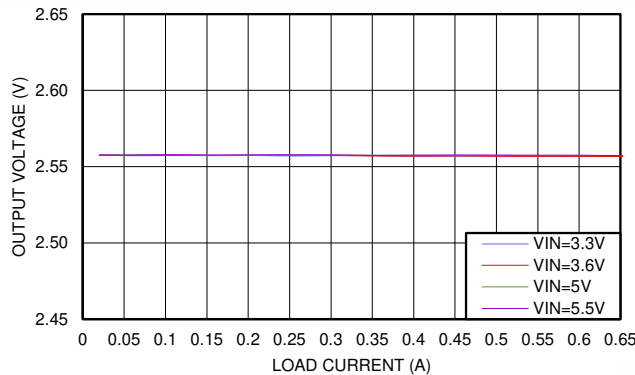

図 8-20. Schematic $V_{OUT} = 3.3\text{ V}$

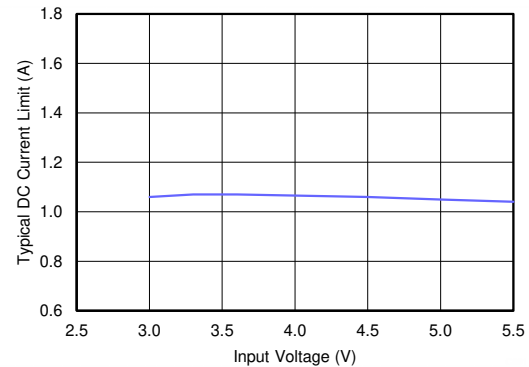

図 8-21. Efficiency $V_{OUT} = 3.3\text{ V}$

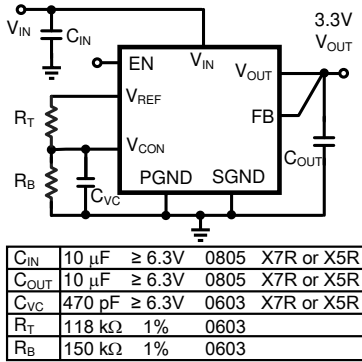

図 8-22. Output Ripple $V_{OUT} = 3.3\text{ V}$

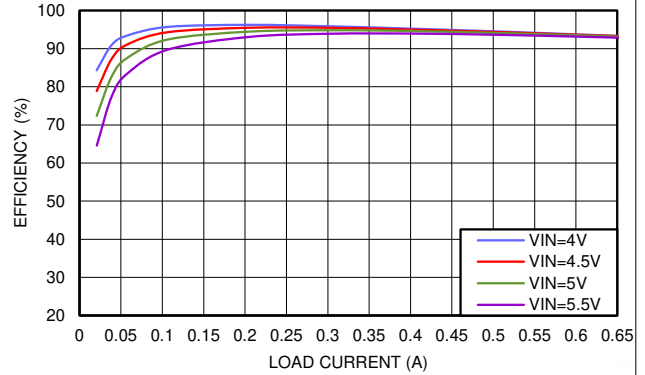

図 8-23. Load Transient $V_{OUT} = 3.3\text{ V}$

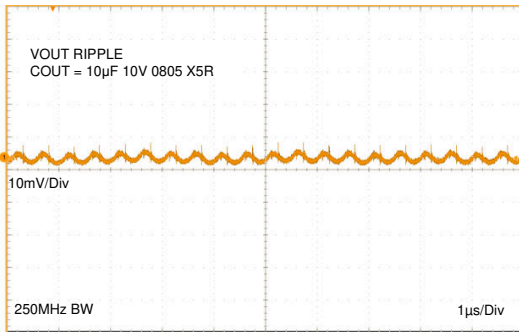

図 8-24. Line and Load Regulation $V_{OUT} = 3.3\text{ V}$

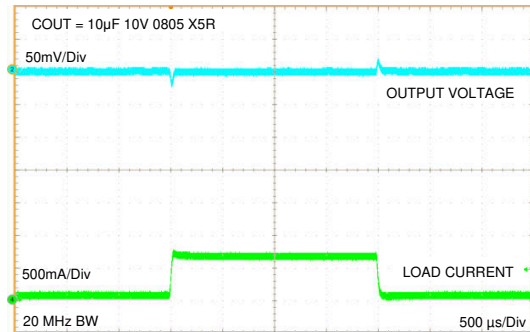

図 8-25. DC Current Limit $V_{OUT} = 3.3\text{ V}$

8.3 Power Supply Recommendations

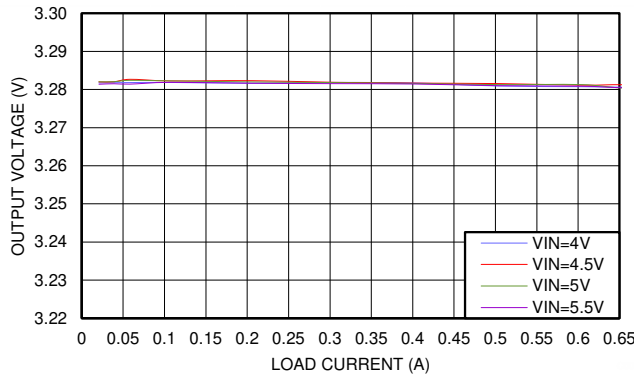
8.3.1 Voltage Range

The voltage of the input supply must not exceed the [セクション 6.1](#) and the [セクション 6.3](#) of the LMZ10500.

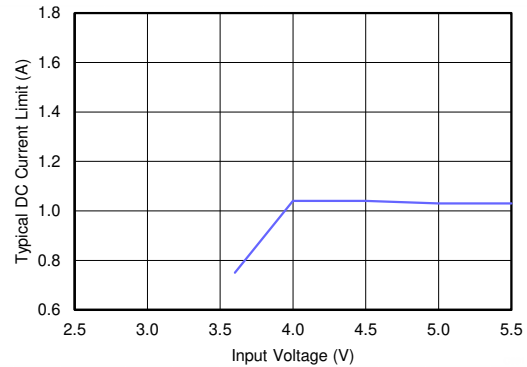
8.3.2 Current Capability

The input supply must be able to supply the required input current to the LMZ10500 converter. The required input current depends on the application's minimum required input voltage (V_{IN-MIN}), the required output power ($V_{OUT} \times I_{OUT-MAX}$), and the converter efficiency (η).

$$I_{IN} = V_{OUT} \times I_{OUT-MAX} / (V_{IN-MIN} \times \eta)$$

For example, for a design with 5-V minimum input voltage, 1.8-V output, and 0.5-A maximum load, considering 90% conversion efficiency, the required input current at steady state is 0.2 A.

8.3.3 Input Connection

Long input connection cables can cause issues with the normal operation of any buck converter.

8.3.3.1 Voltage Drops

Using long input wires to connect the supply to the input of any converter adds impedance in series with the input supply. This impedance can cause a voltage drop at the VIN pin of the converter when the output of the converter is loaded. If the input voltage is near the minimum operating voltage, this added voltage drop can cause the converter to drop out or reset. If long wires are used during testing, it is recommended to add some bulk (i.e. electrolytic) capacitance at the input of the converter.

8.3.3.2 Stability

The added inductance of long input cables together with the ceramic (and low ESR) input capacitor can result in an under damped RLC network at the input of the Buck converter. This can cause oscillations on the input and instability. If long wires are used, it is recommended to add some electrolytic capacitance in parallel with the ceramic input capacitor. The electrolytic capacitor's ESR will improve the damping.

Use an electrolytic capacitor with $C_{\text{ELECTROLYTIC}} \geq 4 \times C_{\text{CERAMIC}}$ and $\text{ESR}_{\text{ELECTROLYTIC}} \approx \sqrt{L_{\text{CABLE}} / C_{\text{CERAMIC}}}$

For example, two cables (one for VIN and one for GND), each 1 meter (~3 ft) long with ~1 mm diameter (18AWG), placed 1 cm (~0.4 in) apart will form a rectangular loop resulting in about 1.2 μH of inductance. The inductance in this example can be decreased to almost half if the input wires are twisted. Based on a 10- μF ceramic input capacitor, the recommended parallel $C_{\text{ELECTROLYTIC}}$ is $\geq 40 \mu\text{F}$. Using a 47- μF capacitor will be sufficient. The recommended $\text{ESR}_{\text{ELECTROLYTIC}} \approx 0.35 \Omega$ or larger, based on about 1.2 μH of inductance and 10 μF of ceramic input capacitance.

See application note [SNVA489](#) for more details on input filter design.

8.4 Layout

8.4.1 Layout Guidelines

The board layout of any DC/DC switching converter is critical for the optimal performance of the design. Bad PCB layout design can disrupt the operation of an otherwise good schematic design. Even if the regulator still converts the voltage properly, the board layout can mean the difference between passing or failing EMI regulations. In a Buck converter, the most critical board layout path is between the input capacitor ground terminal and the synchronous rectifier ground. The loop formed by the input capacitor and the power FETs is a path for the high di/dt switching current during each switching period. This loop must always be kept as short as possible when laying out a board for any Buck converter.

The LMZ10500 integrates the inductor and simplifies the DC/DC converter board layout. Refer to the example layout in [Figure 8-26](#). There are a few basic requirements to achieve a good LMZ10500 layout.

1. Place the input capacitor C_{IN} as close as possible to the V_{IN} and PGND pins. V_{IN} (pin 7) and PGND (pin 6) on the LMZ10500 are next to each other which makes the input capacitor placement simple.
2. Place the V_{CON} filter capacitor C_{VC} and the R_{B} R_{T} resistive divider as close as possible to the V_{CON} and SGND terminals. The C_{VC} capacitor (not R_{B}) must be the component closer to the V_{CON} pin, as shown in [Figure 8-26](#). This allows for better bypass of the control voltage set at V_{CON} .
3. Run the feedback trace (from V_{OUT} to FB) away from noise sources.
4. Connect SGND to a quiet GND plane.
5. Provide enough PCB area for proper heatsinking. Refer to the [Section 6.5](#) table for example θ_{JA} values for different board areas. Also, refer to AN-2020 for additional thermal design hints.

Refer to the evaluation board user's guide [LMZ10501SIL and LMZ10500SIL SIMPLE SWITCHER® Nano Module Evaluation Board](#) for a complete board layout example.

8.4.2 Layout Example



図 8-26. Example Top Layer Board Layout

8.4.3 Package Considerations

Use the following recommendations when using machine placement :

- Use 1.06 mm (42 mil) or smaller nozzle size. The pickup area is the top of the inductor, which is 1.6 mm × 2 mm.
- Soft tip pick and place nozzle is recommended.
- Add 0.05 mm to the component thickness so that the device will be released 0.05 mm (2 mil) into the solder paste without putting pressure or splashing the solder paste.
- Slow the pick arm when picking the part from the tape and reel carrier and when depositing the IC on the board.
- If the machine releases the component by force, use minimum force or no more than 3 Newtons.

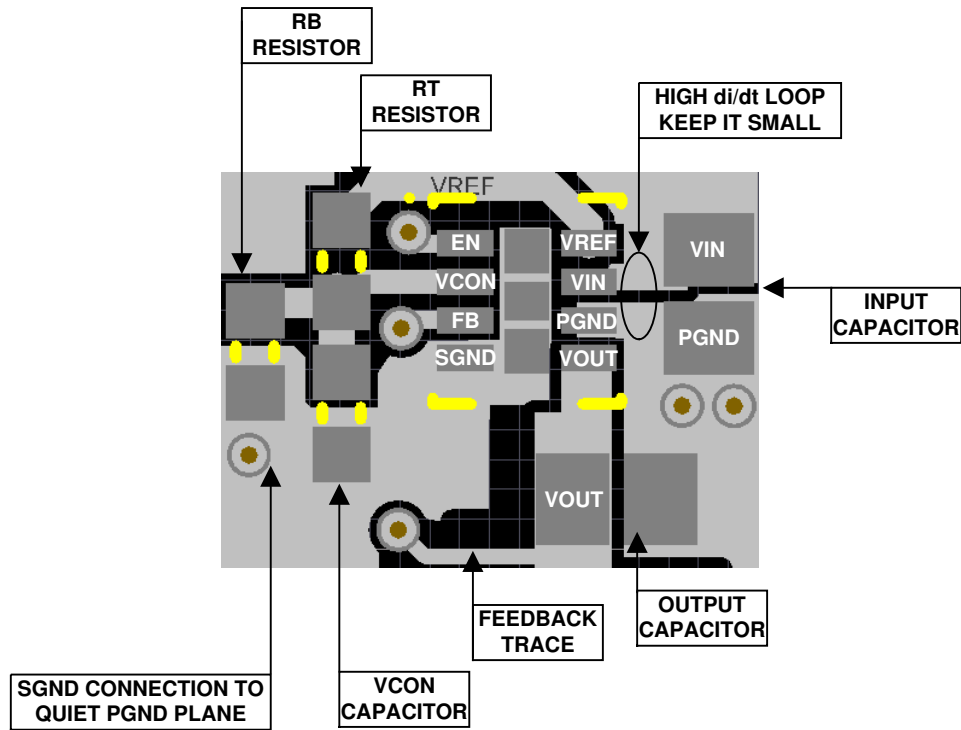
For manual placement:

- Use a vacuum pick up hand tool with soft tip head.
- If vacuum pick up tool is not available, use non-metal tweezers and hold the part by sides.
- Use minimal force when picking and placing the module on the board.
- Using hot air station provides better temperature control and better controlled air flow than a heat gun.
- Go to the video section at www.ti.com/product/lmz10500 for a quick video on how to solder rework the LMZ10500.

9 Device and Documentation Support

9.1 Device Support

9.1.1 Custom Design With WEBENCH® Tools

[Click here](#) to create a custom design using the LMZ10500 device with the WEBENCH® Power Designer.

1. Start by entering the input voltage (V_{IN}), output voltage (V_{OUT}), and output current (I_{OUT}) requirements.
2. Optimize the design for key parameters such as efficiency, footprint, and cost using the optimizer dial.
3. Compare the generated design with other possible solutions from Texas Instruments.

The WEBENCH Power Designer provides a customized schematic along with a list of materials with real-time pricing and component availability.

In most cases, these actions are available:

- Run electrical simulations to see important waveforms and circuit performance
- Run thermal simulations to understand board thermal performance
- Export customized schematic and layout into popular CAD formats
- Print PDF reports for the design, and share the design with colleagues

Get more information about WEBENCH tools at www.ti.com/WEBENCH.

9.2 Documentation Support

9.2.1 Related Documentation

- Texas Instruments, [AN-2162 Simple Success With Conducted EMI From DC-DC Converters application report](#)
- Texas Instruments, [LMZ10501SIL and LMZ10500SIL SIMPLE SWITCHER® Nano Module Evaluation Board user's guide](#)

9.3 ドキュメントの更新通知を受け取る方法

ドキュメントの更新についての通知を受け取るには、ti.com のデバイス製品フォルダを開いてください。「更新の通知を受け取る」をクリックして登録すると、変更されたすべての製品情報に関するダイジェストを毎週受け取れます。変更の詳細については、修正されたドキュメントに含まれている改訂履歴をご覧ください。

9.4 サポート・リソース

[TI E2E™ サポート・フォーラム](#)は、エンジニアが検証済みの回答と設計に関するヒントをエキスパートから迅速かつ直接得ることができる場所です。既存の回答を検索したり、独自の質問をしたりすることで、設計に必要な支援を迅速に得ることができます。

リンクされているコンテンツは、該当する貢献者により、現状のまま提供されるものです。これらは TI の仕様を構成するものではなく、必ずしも TI の見解を反映したものではありません。TI の[使用条件](#)を参照してください。

9.5 Trademarks

TI E2E™ is a trademark of Texas Instruments.

WEBENCH® and SIMPLE SWITCHER® are registered trademarks of Texas Instruments.

すべての商標は、それぞれの所有者に帰属します。

9.6 静電気放電に関する注意事項



この IC は、ESD によって破損する可能性があります。テキサス・インスツルメンツは、IC を取り扱う際には常に適切な注意を払うことを推奨します。正しい取り扱いおよび設置手順に従わない場合、デバイスを破損するおそれがあります。

ESD による破損は、わずかな性能低下からデバイスの完全な故障まで多岐にわたります。精密な IC の場合、パラメータがわずかに変化するだけで公表されている仕様から外れる可能性があるため、破損が発生しやすくなっています。

9.7 用語集

[テキサス・インスツルメンツ用語集](#)

この用語集には、用語や略語の一覧および定義が記載されています。

10 Mechanical, Packaging, and Orderable Information

The following pages include mechanical, packaging, and orderable information. This information is the most current data available for the designated devices. This data is subject to change without notice and revision of this document. For browser-based versions of this data sheet, refer to the left-hand navigation.

MECHANICAL DATA

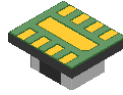

SIL0008A

MicroSiP - 1.5mm max height

SYSTEM IN PACKAGE

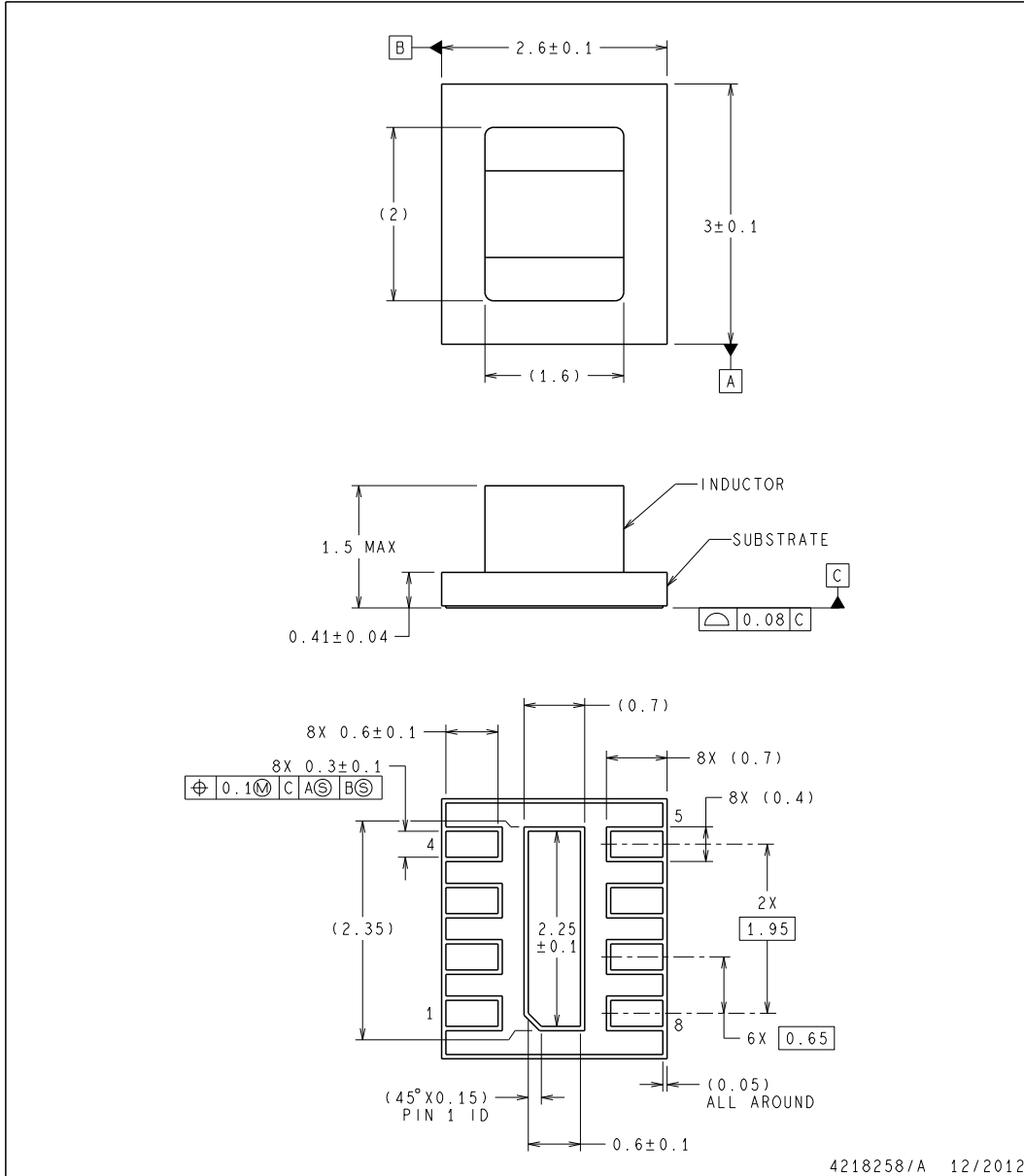

- NOTES:
1. DIMENSIONS ARE IN MILLIMETERS. DIMENSIONS IN PARENTHESIS ARE FOR REFERENCE ONLY.
 2. THIS DRAWING IS SUBJECT TO CHANGE WITHOUT NOTICE.
 3. NO JEDEC REFERENCE AS OF NOVEMBER 2012.
 4. R-uSiP-N8.

MECHANICAL DATA

SIL0008A

MicroSiP - 1.5mm max height

SYSTEM IN PACKAGE

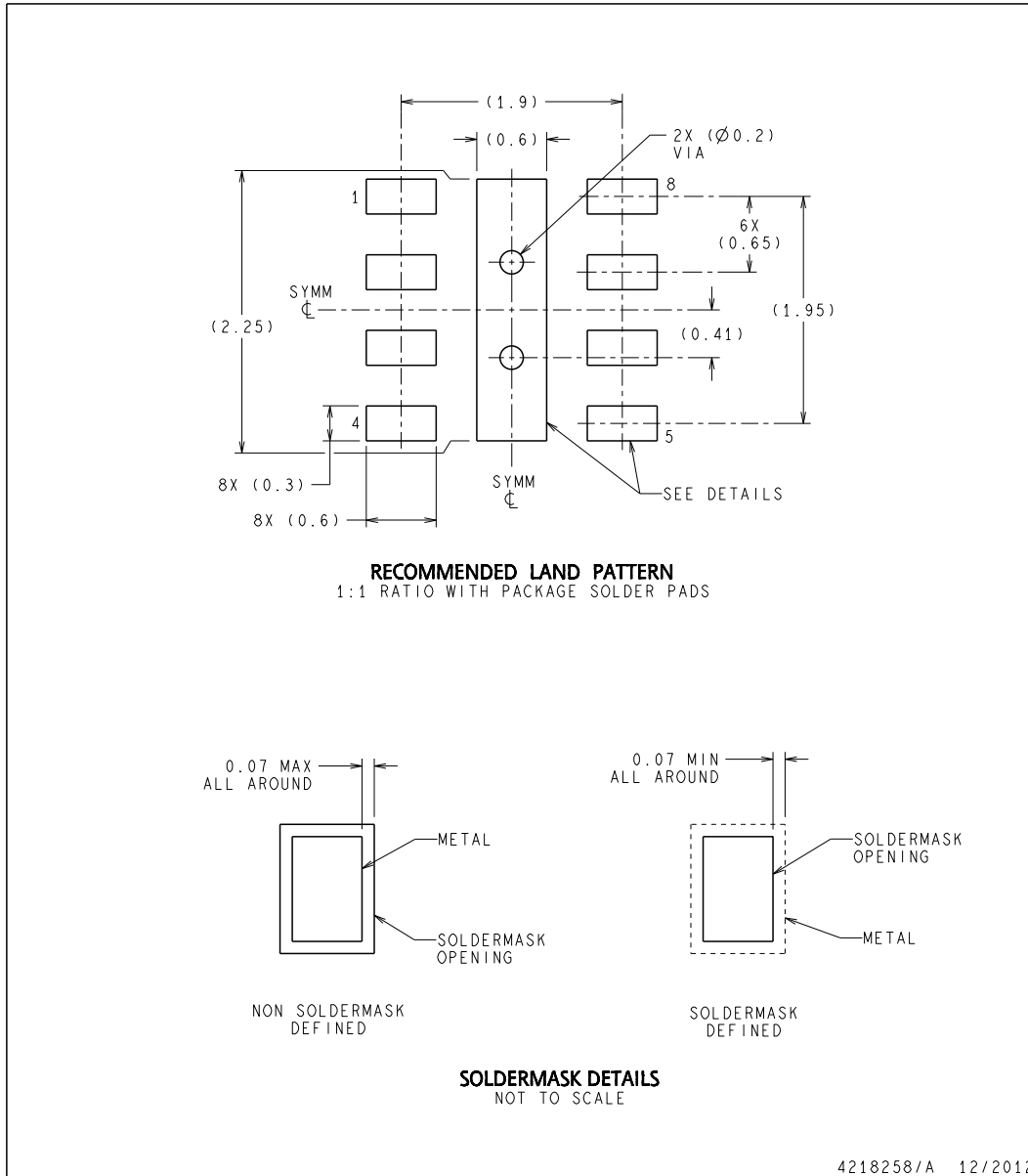

MECHANICAL DATA

SIL0008A

MicroSiP - 1.5mm max height

SYSTEM IN PACKAGE

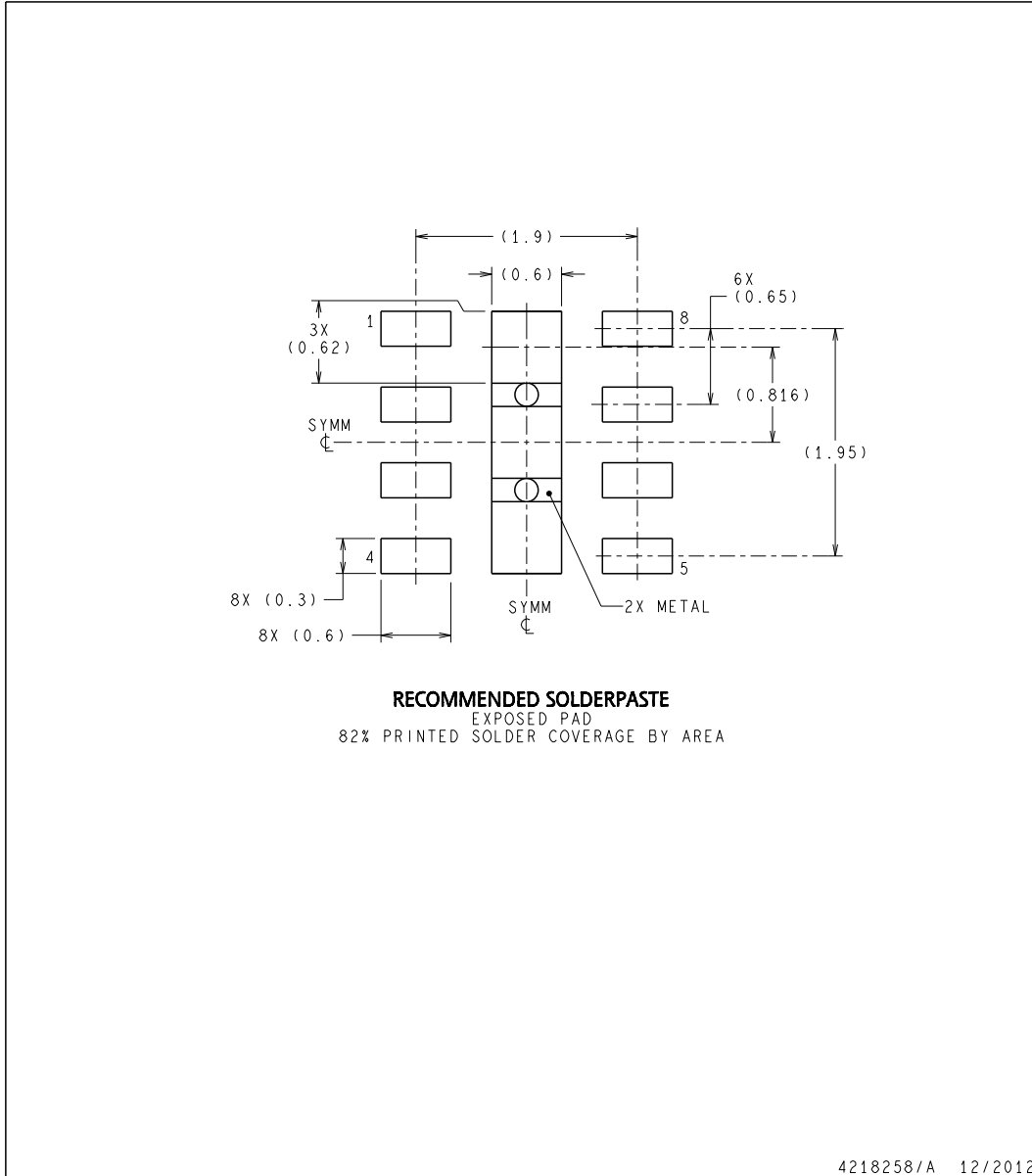

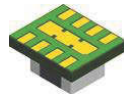

SIL0008G

PACKAGE OUTLINE

uSiP - 1.5mm max height

MICRO SYSTEM IN PACKAGE

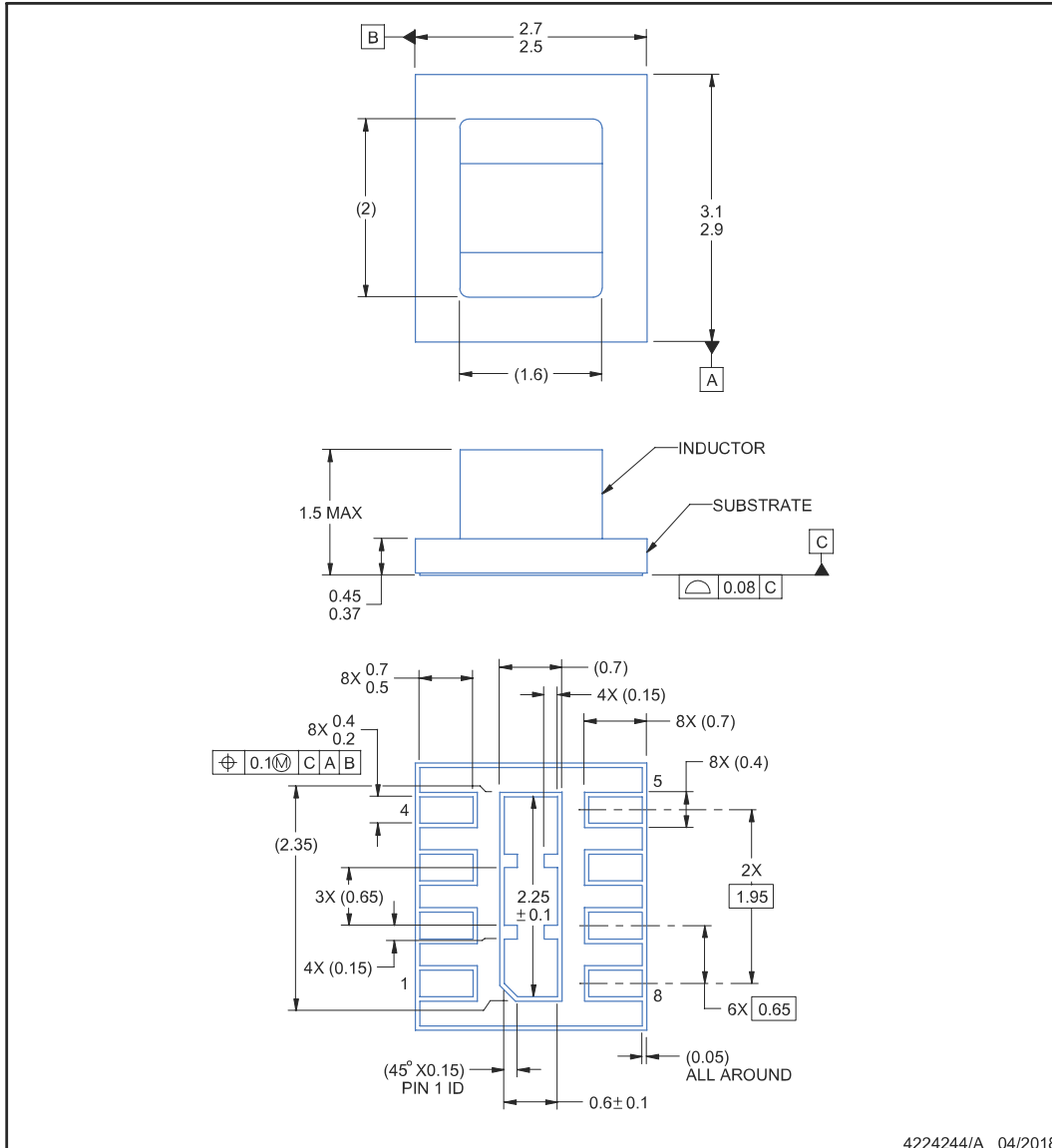

NOTES:

1. All linear dimensions are in millimeters. Any dimensions in parenthesis are for reference only. Dimensioning and tolerancing per ASME Y14.5M.
2. This drawing is subject to change without notice.
3. Pick and place nozzle \varnothing 1.3 mm or smaller recommended.



EXAMPLE STENCIL DESIGN

SIL0008G

uSiP - 1.5mm max height

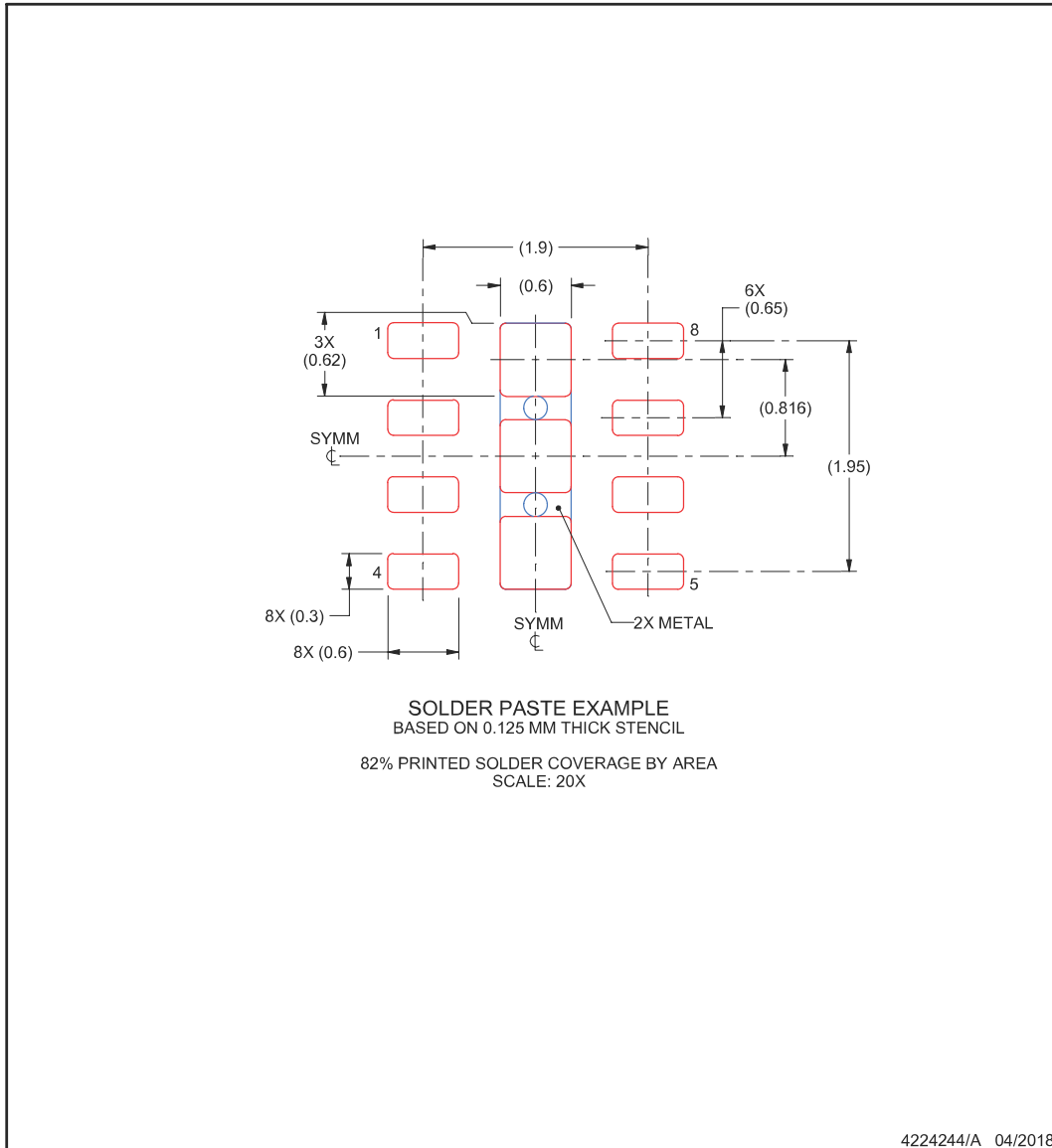

MICRO SYSTEM IN PACKAGE



NOTES: (continued)

- 5. Laser cutting apertures with trapezoidal walls and rounded corners may offer better paste release. IPC-7525 may have alternate design recommendations.

PACKAGING INFORMATION

Orderable Device	Status (1)	Package Type	Package Drawing	Pins	Package Qty	Eco Plan (2)	Lead finish/ Ball material (6)	MSL Peak Temp (3)	Op Temp (°C)	Device Marking (4/5)	Samples
LMZ10500SILR	ACTIVE	uSiP	SIL	8	3000	RoHS & Green	NIAU	Level-3-260C-168 HR	-40 to 125	500 0500 9821 DH	
LMZ10500SILT	ACTIVE	uSiP	SIL	8	250	RoHS & Green	NIAU	Level-3-260C-168 HR	-40 to 125	500 0500 9821 DH	

(1) The marketing status values are defined as follows:

ACTIVE: Product device recommended for new designs.

LIFEBUY: TI has announced that the device will be discontinued, and a lifetime-buy period is in effect.

NRND: Not recommended for new designs. Device is in production to support existing customers, but TI does not recommend using this part in a new design.

PREVIEW: Device has been announced but is not in production. Samples may or may not be available.

OBSOLETE: TI has discontinued the production of the device.

(2) **RoHS:** TI defines "RoHS" to mean semiconductor products that are compliant with the current EU RoHS requirements for all 10 RoHS substances, including the requirement that RoHS substance do not exceed 0.1% by weight in homogeneous materials. Where designed to be soldered at high temperatures, "RoHS" products are suitable for use in specified lead-free processes. TI may reference these types of products as "Pb-Free".

RoHS Exempt: TI defines "RoHS Exempt" to mean products that contain lead but are compliant with EU RoHS pursuant to a specific EU RoHS exemption.

Green: TI defines "Green" to mean the content of Chlorine (Cl) and Bromine (Br) based flame retardants meet JS709B low halogen requirements of <=1000ppm threshold. Antimony trioxide based flame retardants must also meet the <=1000ppm threshold requirement.

(3) MSL, Peak Temp. - The Moisture Sensitivity Level rating according to the JEDEC industry standard classifications, and peak solder temperature.

(4) There may be additional marking, which relates to the logo, the lot trace code information, or the environmental category on the device.

(5) Multiple Device Markings will be inside parentheses. Only one Device Marking contained in parentheses and separated by a "~" will appear on a device. If a line is indented then it is a continuation of the previous line and the two combined represent the entire Device Marking for that device.

(6) Lead finish/Ball material - Orderable Devices may have multiple material finish options. Finish options are separated by a vertical ruled line. Lead finish/Ball material values may wrap to two lines if the finish value exceeds the maximum column width.

Important Information and Disclaimer:The information provided on this page represents TI's knowledge and belief as of the date that it is provided. TI bases its knowledge and belief on information provided by third parties, and makes no representation or warranty as to the accuracy of such information. Efforts are underway to better integrate information from third parties. TI has taken and continues to take reasonable steps to provide representative and accurate information but may not have conducted destructive testing or chemical analysis on incoming materials and chemicals. TI and TI suppliers consider certain information to be proprietary, and thus CAS numbers and other limited information may not be available for release.

In no event shall TI's liability arising out of such information exceed the total purchase price of the TI part(s) at issue in this document sold by TI to Customer on an annual basis.

TAPE AND REEL INFORMATION

QUADRANT ASSIGNMENTS FOR PIN 1 ORIENTATION IN TAPE

*All dimensions are nominal

Device	Package Type	Package Drawing	Pins	SPQ	Reel Diameter (mm)	Reel Width W1 (mm)	A0 (mm)	B0 (mm)	K0 (mm)	P1 (mm)	W (mm)	Pin1 Quadrant
LMZ10500SILR	uSiP	SIL	8	3000	330.0	12.4	2.85	3.25	1.7	4.0	12.0	Q1

TAPE AND REEL BOX DIMENSIONS

*All dimensions are nominal

Device	Package Type	Package Drawing	Pins	SPQ	Length (mm)	Width (mm)	Height (mm)
LMZ10500SILR	uSiP	SIL	8	3000	383.0	353.0	58.0

重要なお知らせと免責事項

TI は、技術データと信頼性データ (データシートを含みます)、設計リソース (リファレンス・デザインを含みます)、アプリケーションや設計に関する各種アドバイス、Web ツール、安全性情報、その他のリソースを、欠陥が存在する可能性のある「現状のまま」提供しており、商品性および特定目的に対する適合性の黙示保証、第三者の知的財産権の非侵害保証を含むいかなる保証も、明示的または黙示的にかかわらず拒否します。

これらのリソースは、TI 製品を使用する設計の経験を積んだ開発者への提供を意図したものです。(1) お客様のアプリケーションに適した TI 製品の選定、(2) お客様のアプリケーションの設計、検証、試験、(3) お客様のアプリケーションに該当する各種規格や、その他のあらゆる安全性、セキュリティ、規制、または他の要件への確実な適合に関する責任を、お客様のみが単独で負うものとし、

上記の各種リソースは、予告なく変更される可能性があります。これらのリソースは、リソースで説明されている TI 製品を使用するアプリケーションの開発の目的でのみ、TI はその使用をお客様に許諾します。これらのリソースに関して、他の目的で複製することや掲載することは禁止されています。TI や第三者の知的財産権のライセンスが付与されている訳ではありません。お客様は、これらのリソースを自身で使用した結果発生するあらゆる申し立て、損害、費用、損失、責任について、TI およびその代理人を完全に補償するものとし、TI は一切の責任を拒否します。

TI の製品は、[TI の販売条件](#)、または [ti.com](https://www.ti.com) やかかる TI 製品の関連資料などのいずれかを通じて提供する適用可能な条項の下で提供されています。TI がこれらのリソースを提供することは、適用される TI の保証または他の保証の放棄の拡大や変更を意味するものではありません。

お客様がいかなる追加条項または代替条項を提案した場合でも、TI はそれらに異議を唱え、拒否します。

郵送先住所 : Texas Instruments, Post Office Box 655303, Dallas, Texas 75265
Copyright © 2023, Texas Instruments Incorporated