

# LMC7101 レール ツー レール入出力、超小型、低消費電力オペアンプ

## 1 特長

- 超小型の 5 ピン SOT-23 パッケージによりスペースを削減できます。標準的な回路レイアウトは 8 ピン SOIC 設計の半分のスペースを占有します
- 2.7V、3V、5V、および 15V 電源について規定
- 電源電流 (標準値): 5V で 0.5mA
- 全高調波歪み (標準値): 5V で 0.01%
- 1MHz ゲイン帯域幅
- 産業用温度範囲について規定: -40°C ~ +85°C
- 一般的な LMC6482 および LMC6484 と類似し
- レール ツー レール入出力

## 2 アプリケーション

- モバイル通信
- ノート PC および PDA
- バッテリー駆動製品
- センサ インターフェイス
- 車載用アプリケーション

## 3 概要

LMC7101 デバイスは高性能な車載用 CMOS オペアンプで、省スペースの 5 ピン SOT-23 小型パッケージで提供されます。この設計により、LMC7101 はスペースと重量の制約が厳しい設計にも最適です。性能は LMC6482 および LMC6484 のシングル アンプと同様で、レール ツー レールの入出力、高い開ループ ゲイン、低歪み、低消費電流を特長としています。

この超小型パッケージの主な利点は、携帯電話、ポケベル、ノートパソコン、携帯情報端末、PCMCIA カードなどの小型の携帯用電子デバイスにおいて最も明白です。超小型アンプは必要に応じて基板に配置できるため、基板レイアウトを簡素化できます。

### パッケージ情報

部品番号	パッケージ (1)	パッケージ サイズ (2)
LMC7101	DBV (SOT-23, 5)	2.9mm × 2.8mm

(1) 詳細については、[セクション 10](#) を参照してください。

(2) パッケージ サイズ (長さ×幅) は公称値であり、該当する場合はピンも含まれます。

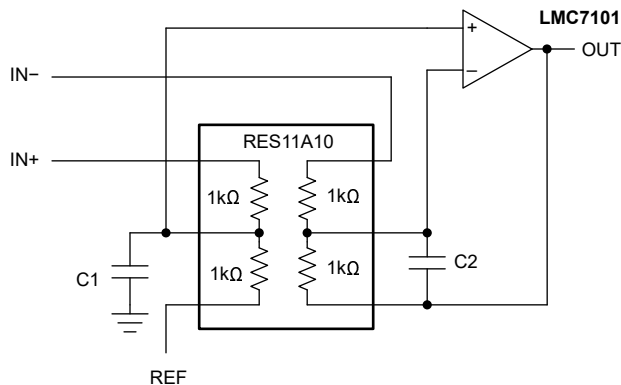

RES11A を使った差動アンプのアプリケーション



## Table of Contents

<b>1 特長</b> .....	1	6.2 Functional Block Diagram.....	21
<b>2 アプリケーション</b> .....	1	6.3 Feature Description.....	21
<b>3 概要</b> .....	1	6.4 Device Functional Modes.....	22
<b>4 Pin Configuration and Functions</b> .....	2	<b>7 Application and Implementation</b> .....	23
<b>5 Specifications</b> .....	3	7.1 Application Information.....	23
5.1 Absolute Maximum Ratings.....	3	7.2 Typical Application.....	24
5.2 ESD Ratings.....	3	7.3 Power Supply Recommendations.....	26
5.3 Recommended Operating Conditions.....	3	7.4 Layout.....	26
5.4 Thermal Information.....	3	<b>8 Device and Documentation Support</b> .....	27
5.5 Electrical Characteristics for $V_S = \pm 1.35V$ or $2.7V$ .....	4	8.1 Documentation Support.....	27
5.6 Electrical Characteristics for $V_S = \pm 1.5V$ or $3V$ .....	5	8.2 ドキュメントの更新通知を受け取る方法.....	27
5.7 Electrical Characteristics for $V_S = \pm 2.5V$ or $5V$ .....	6	8.3 サポート・リソース.....	27
5.8 Electrical Characteristics for $V_S = \pm 7.5V$ or $15V$ .....	8	8.4 Trademarks.....	27
5.9 Typical Characteristics for $V_S = 2.7V$ .....	10	8.5 静電気放電に関する注意事項.....	27
5.10 Typical Characteristics for $V_S = 3V$ .....	12	8.6 用語集.....	27
5.11 Typical Characteristics for $V_S = 5V$ .....	13	<b>9 Revision History</b> .....	27
5.12 Typical Characteristics for $V_S = 15V$ .....	14	<b>10 Mechanical, Packaging, and Orderable Information</b> .....	28
<b>6 Detailed Description</b> .....	21		
6.1 Overview.....	21		

## 4 Pin Configuration and Functions



図 4-1. DBV Package, 5-Pin SOT-23 (Top View)

表 4-1. Pin Functions

PIN		TYPE	DESCRIPTION
NO.	NAME		
1	OUT	Output	Output
2	V+	Power	Positive supply
3	+IN	Input	Noninverting input
4	-IN	Input	Inverting input
5	V-	Power	Negative supply

## 5 Specifications

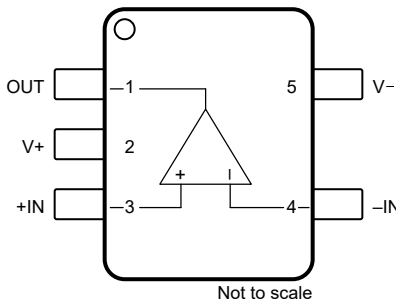
### 5.1 Absolute Maximum Ratings

over operating free-air temperature range (unless otherwise noted)<sup>(1)</sup> <sup>(2)</sup>

		MIN	MAX	UNIT
	Difference Input voltage		±Supply voltage	V
	Voltage at input and output pins	(V-) – 0.3	(V+) + 0.3	V
V <sub>S</sub>	Supply voltage, V <sub>S</sub> = (V+) – (V-)		16	V
	Current at input pin	-5	5	mA
	Current at output pin <sup>(3)</sup>	-35	35	mA
	Current at power supply pin		35	mA
	Lead temperature (soldering, 10s)		260	°C
T <sub>J</sub>	Junction temperature <sup>(4)</sup>		150	°C
T <sub>stg</sub>	Storage temperature	-65	150	°C

- (1) Operation outside the *Absolute Maximum Ratings* may cause permanent device damage. *Absolute Maximum Ratings* do not imply functional operation of the device at these or any other conditions beyond those listed under *Recommended Operating Conditions*. If used outside the *Recommended Operating Conditions* but within the *Absolute Maximum Ratings*, the device may not be fully functional, and this may affect device reliability, functionality, performance, and shorten the device lifetime.
- (2) If Military/Aerospace specified devices are required, contact the TI Sales Office or Distributors for availability and specifications.
- (3) Applies to both single-supply and split-supply operation. Continuous short operation at elevated ambient temperature can result in exceeding the maximum allowed junction temperature at 150°C
- (4) The maximum power dissipation is a function of T<sub>J(MAX)</sub>, R<sub>θJA</sub> and T<sub>A</sub>. The maximum allowable power dissipation at any ambient temperature is P<sub>D</sub> = (T<sub>J(MAX)</sub> – T<sub>A</sub>) / R<sub>θJA</sub>. All numbers apply for packages soldered directly into a PC board.

### 5.2 ESD Ratings

			VALUE	UNIT
V <sub>(ESD)</sub>	Electrostatic discharge	Human-body model (HBM), per ANSI/ESDA/JEDEC JS-001 <sup>(1)</sup>	±1000	V
		Charged-device model (CDM), per JEDEC specification JESD22-C101 <sup>(2)</sup>	±1000	

- (1) JEDEC document JEP155 states that 500V HBM allows safe manufacturing with a standard ESD control process.
- (2) JEDEC document JEP157 states that 250V CDM allows safe manufacturing with a standard ESD control process.

### 5.3 Recommended Operating Conditions

over operating free-air temperature range (unless otherwise noted)

		MIN	NOM	MAX	UNIT
V <sub>S</sub>	Supply voltage, V <sub>S</sub> = (V+) – (V-)	2.7		15.5	V
T <sub>J</sub>	Junction temperature	-40		85	°C

### 5.4 Thermal Information

THERMAL METRIC <sup>(1)</sup>		LMC7101	UNIT
		DBV (SOT)	
		5 PINS	
R <sub>θJA</sub>	Junction-to-ambient thermal resistance	193.5	°C/W
R <sub>θJC(top)</sub>	Junction-to-case(top) thermal resistance	128.5	°C/W
R <sub>θJB</sub>	Junction-to-board thermal resistance	88.9	°C/W
ψ <sub>JT</sub>	Junction-to-top characterization parameter	66.8	°C/W
ψ <sub>JB</sub>	Junction-to-board characterization parameter	88.6	°C/W
R <sub>θJC(bot)</sub>	Junction-to-case(bottom) thermal resistance	N/A	°C/W

- (1) For information about traditional and new thermal metrics, see the [Semiconductor and IC Package Thermal Metrics](#) application report.

## 5.5 Electrical Characteristics for $V_S = \pm 1.35V$ or $2.7V$

at  $T_J = 25^\circ C$ ,  $V_+ = 2.7V$ ,  $V_- = 0V$ ,  $V_{CM} = V_{OUT} = V_+ / 2$ , and  $R_L > 1M\Omega$  connected to  $V_+ / 2$  (unless otherwise noted)

PARAMETER		TEST CONDITIONS		MIN	TYP	MAX	UNIT
<b>OFFSET VOLTAGE</b>							
$V_{OS}$	Input offset voltage	LMC7101A			$\pm 0.11$	$\pm 6$	mV
		LMC7101B			$\pm 0.11$	$\pm 9$	
$dV_{OS}/dT$	Input offset voltage drift	$T_J = -40^\circ C$ to $+85^\circ C$			1		$\mu V/^\circ C$
PSRR	Power-supply rejection ratio	$V_+ = 1.35V$ to $1.65V$ , $V_- = -1.35V$ to $-1.65V$ , $V_{CM} = 0V$		45	60		dB
<b>INPUT BIAS CURRENT</b>							
$I_B$	Input bias current	$T_J = -40^\circ C$ to $+85^\circ C$			$\pm 1$	$\pm 64$	pA
$I_{OS}$	Input offset current	$T_J = -40^\circ C$ to $+85^\circ C$			$\pm 0.5$	$\pm 32$	pA
<b>INPUT VOLTAGE</b>							
$V_{CM}$	Input common-mode voltage	For CMRR $\geq 47$ dB	Positive	2.7	3		V
			Negative		0	0	
CMRR	Common-mode rejection	$0V \leq V_{CM} \leq 2.7V$		47	70		dB
<b>INPUT IMPEDANCE</b>							
$R_{IN}$	Input resistance				$> 1$		$T\Omega$
$C_{IN}$	Common-mode input capacitance				3		pF
<b>FREQUENCY RESPONSE</b>							
GBW	Gain bandwidth product				0.6		MHz
SR	Slew rate <sup>(1)</sup>	$(V_+) = 15V$ , 10V step, $R_L = 100k\Omega$ to $7.5V$ , $V_{OUT} = 10V_{PP}$ , $f = 1kHz$			0.7		V/ $\mu s$
<b>OUTPUT</b>							
$V_O$	Voltage output swing	Positive rail	$R_L = 2k\Omega$	2.15	2.45		V
			$R_L = 10k\Omega$	2.64	2.68		
		Negative rail	$R_L = 2k\Omega$		0.25	0.5	
			$R_L = 10k\Omega$		0.025	0.06	
<b>POWER SUPPLY</b>							
$I_Q$	Quiescent current per amplifier				500	810	$\mu A$
		$T_J = -40^\circ C$ to $+85^\circ C$			500	950	

(1) Number specified is the slower of the positive and negative slew rates.

## 5.6 Electrical Characteristics for $V_S = \pm 1.5V$ or $3V$

at  $T_J = 25^\circ C$ ,  $V_+ = 3V$ ,  $V_- = 0V$ ,  $V_{CM} = V_{OUT} = V_+ / 2$ , and  $R_L = 1M\Omega$  connected to  $V_+ / 2$  (unless otherwise noted)

PARAMETER		TEST CONDITIONS		MIN	TYP	MAX	UNIT
<b>OFFSET VOLTAGE</b>							
$V_{OS}$	Input offset voltage	LMC7101A			$\pm 0.11$	$\pm 3$	mV
		LMC7101B			$\pm 0.11$	$\pm 7$	
$dV_{OS}/dT$	Input offset voltage drift	$T_J = -40^\circ C$ to $+85^\circ C$			1		$\mu V/^\circ C$
PSRR	Power-supply rejection ratio	$V_+ = 1.5V$ to $7.5V$ $V_- = -1.5V$ to $-7.5V$ $V_{OUT} = V_{CM} = 0V$	LMC7101A	68	80		dB
			LMC7101B	60	80		
<b>INPUT BIAS CURRENT</b>							
$I_B$	Input bias current	$T_J = -40^\circ C$ to $+85^\circ C$			$\pm 1$	$\pm 64$	pA
$I_{OS}$	Input offset current	$T_J = -40^\circ C$ to $+85^\circ C$			$\pm 0.5$	$\pm 32$	pA
<b>INPUT VOLTAGE</b>							
$V_{CM}$	Input common-mode voltage	For CMRR $\geq 47dB$	Positive	3	3.3		V
			Negative		0	0	
CMRR	Common-mode rejection	$0V \leq V_{CM} \leq 3V$		47	70		dB
<b>INPUT IMPEDANCE</b>							
$R_{IN}$	Input resistance				$> 1$		$T\Omega$
$C_{IN}$	Common-mode input capacitance				3		pF
<b>OUTPUT</b>							
$V_O$	Voltage output swing	Positive rail	$R_L = 2k\Omega$	2.6	2.8		V
			$R_L = 600\Omega$	2.5	2.7		
		Negative rail	$R_L = 2k\Omega$		0.2	0.4	
			$R_L = 600\Omega$		0.37	0.6	
<b>POWER SUPPLY</b>							
$I_Q$	Quiescent current per amplifier				500	810	$\mu A$
		$T_J = -40^\circ C$ to $+85^\circ C$			500	950	

## 5.7 Electrical Characteristics for $V_S = \pm 2.5V$ or $5V$

at  $T_J = 25^\circ\text{C}$ ,  $V_+ = 5V$ ,  $V_- = 0V$ ,  $V_{CM} = V_{OUT} = V_+ / 2$ , and  $R_L = 1M\Omega$  connected to  $V_+ / 2$  (unless otherwise noted)

PARAMETER		TEST CONDITIONS		MIN	TYP	MAX	UNIT
<b>OFFSET VOLTAGE</b>							
$V_{OS}$	Input offset voltage	LMC7101A			$\pm 0.11$	$\pm 3$	mV
			$T_J = -40^\circ\text{C to } +85^\circ\text{C}$		$\pm 0.11$	$\pm 5$	
		LMC7101B			$\pm 0.11$	$\pm 7$	
			$T_J = -40^\circ\text{C to } +85^\circ\text{C}$		$\pm 0.11$	$\pm 9$	
$dV_{OS}/dT$	Input offset voltage drift	$T_J = -40^\circ\text{C to } +85^\circ\text{C}$			1		$\mu\text{V}/^\circ\text{C}$
PSRR	Power-supply rejection ratio	Positive $V_+ = 5V$ to $15V$ $V_- = 0V$ , $V_{OUT} = 1.5V$	LMC7101A	70	82	dB	
			LMC7101B	65	82		
			LMC7101A $T_J = -40^\circ\text{C to } +85^\circ\text{C}$	65	82		
			LMC7101B $T_J = -40^\circ\text{C to } +85^\circ\text{C}$	62	82		
		Negative $V_+ = -5V$ to $-15V$ $V_- = 0V$ , $V_{OUT} = -1.5V$	LMC7101A	70	82		
			LMC7101B	65	82		
			LMC7101A $T_J = -40^\circ\text{C to } +85^\circ\text{C}$	65	82		
			LMC7101B $T_J = -40^\circ\text{C to } +85^\circ\text{C}$	62	82		
<b>INPUT BIAS CURRENT</b>							
$I_B$	Input bias current				$\pm 1$		pA
		$T_J = -40^\circ\text{C to } +85^\circ\text{C}$				$\pm 64$	
$I_{OS}$	Input offset current				$\pm 0.5$		pA
		$T_J = -40^\circ\text{C to } +85^\circ\text{C}$				$\pm 32$	
<b>NOISE</b>							
THD	Total harmonic distortion	$f = 10\text{kHz}$ , $G = -2V/V$ , $R_L = 10\text{k}\Omega$ , $V_{OUT} = 4V_{pp}$			0.01		%
<b>INPUT VOLTAGE</b>							
$V_{CM}$	Input common-mode voltage	To positive rail CMRR > 50dB		5.2	5.3	V	
			$T_J = -40^\circ\text{C to } +85^\circ\text{C}$		5		5.3
		To negative rail CMRR > 50dB			-0.3		-0.2
			$T_J = -40^\circ\text{C to } +85^\circ\text{C}$				-0.3
CMRR	Common-mode rejection ratio	$0V \leq V_{CM} \leq 5V$		52	75	dB	
			$T_J = -40^\circ\text{C to } +85^\circ\text{C}$		51		74
<b>INPUT IMPEDANCE</b>							
$R_{IN}$	Input resistance				> 1		$\Omega$
$C_{IN}$	Input capacitance				3		pF
<b>FREQUENCY RESPONSE</b>							
GBW	Gain bandwidth product				1		MHz
SR	Slew rate				1		$\text{V}/\mu\text{s}$

### 5.7 Electrical Characteristics for $V_S = \pm 2.5V$ or $5V$ (続き)

at  $T_J = 25^\circ C$ ,  $V_+ = 5V$ ,  $V_- = 0V$ ,  $V_{CM} = V_{OUT} = V_+ / 2$ , and  $R_L = 1M\Omega$  connected to  $V_+ / 2$  (unless otherwise noted)

PARAMETER		TEST CONDITIONS	MIN	TYP	MAX	UNIT	
<b>OUTPUT</b>							
$V_O$	Voltage output swing	Positive rail $R_L = 2k\Omega$		4.7	4.9	V	
			$T_J = -40^\circ C$ to $+85^\circ C$	4.6	4.9		
		Negative rail $R_L = 2k\Omega$			0.1		0.18
			$T_J = -40^\circ C$ to $+85^\circ C$		0.1		0.24
$I_{SC}$	Short-circuit current	Positive rail $R_L = 600\Omega$		4.5	4.7	mA	
			$T_J = -40^\circ C$ to $+85^\circ C$	4.24	4.7		
		Negative rail $R_L = 600\Omega$			0.3		0.5
			$T_J = -40^\circ C$ to $+85^\circ C$		0.3		0.65
<b>POWER SUPPLY</b>							
$I_Q$	Quiescent current per amplifier			0.5	0.85	mA	
			$T_J = -40^\circ C$ to $+85^\circ C$	0.5	1		

### 5.8 Electrical Characteristics for $V_S = \pm 7.5V$ or $15V$

at  $T_J = 25^\circ C$ ,  $V_+ = 15V$ ,  $V_- = 0V$ ,  $V_{CM} = V_{OUT} = V_+ / 2$ , and  $R_L = 1M\Omega$  connected to  $V_+ / 2$  (unless otherwise noted)

PARAMETER		TEST CONDITIONS		MIN	TYP	MAX	UNIT
<b>OFFSET VOLTAGE</b>							
$V_{OS}$	Input offset voltage				$\pm 0.26$		mV
$dV_{OS}/dT$	Input offset voltage drift	$T_J = -40^\circ C$ to $+85^\circ C$			1		$\mu V/^\circ C$
PSRR	Power-supply rejection ratio	Positive $V_+ = 5V$ to $15V$ $V_- = 0V$ , $V_{OUT} = 1.5V$	LMC7101A	70	82	dB	
			LMC7101B	65	82		
			LMC7101A $T_J = -40^\circ C$ to $+85^\circ C$	65	82		
			LMC7101B $T_J = -40^\circ C$ to $+85^\circ C$	60	82		
		Negative $V_+ = -5V$ to $-15V$ $V_- = 0V$ , $V_{OUT} = -1.5V$	LMC7101A	70	82		
			LMC7101B	65	82		
			LMC7101A $T_J = -40^\circ C$ to $+85^\circ C$	65	82		
			LMC7101B $T_J = -40^\circ C$ to $+85^\circ C$	62	82		
<b>INPUT BIAS CURRENT</b>							
$I_B$	Input bias current				$\pm 1$		pA
		$T_J = -40^\circ C$ to $+85^\circ C$				$\pm 64$	
$I_{OS}$	Input offset current				$\pm 0.5$		pA
		$T_J = -40^\circ C$ to $+85^\circ C$				$\pm 32$	
<b>NOISE</b>							
$e_n$	Input voltage noise density	$f = 1kHz$ , $V_{CM} = 1V$			37		$nV/\sqrt{Hz}$
$i_n$	Input current noise density	$f = 1kHz$			6.8		$fA/\sqrt{Hz}$
THD	Total harmonic distortion	$f = 10kHz$ , $G = -2V/V$ , $R_L = 10k\Omega$ , $V_{OUT} = 8.5V_{pp}$			0.01		%
<b>INPUT VOLTAGE</b>							
$V_{CM}$	Input common-mode voltage	To positive rail CMRR > 50dB		15.2	15.3	V	
			$T_J = -40^\circ C$ to $+85^\circ C$	15	15.3		
		To negative rail CMRR > 50dB		-0.3	-0.2		
			$T_J = -40^\circ C$ to $+85^\circ C$	-0.3	0		
CMRR	Common-mode rejection ratio	$0V \leq V_{CM} \leq 15V$		62	82	dB	
			$T_J = -40^\circ C$ to $+85^\circ C$	60	82		
<b>INPUT IMPEDANCE</b>							
$R_{IN}$	Input resistance				> 1		$T\Omega$
$C_{IN}$	Input capacitance				3		pF
<b>OPEN-LOOP GAIN</b>							
$A_{OL}$	Open-loop voltage gain	Sourcing $7.5V < V_O < 12.5V$ , $V_{CM} = 1.5V$ $R_L = 2k\Omega$ to $7.5V$		80	340	V/mV	
			$T_J = -40^\circ C$ to $+85^\circ C$	40	340		
		Sinking $2.5V < V_O < 7.5V$ , $V_{CM} = 1.5V$ $R_L = 2k\Omega$ to $7.5V$		15	24		
			$T_J = -40^\circ C$ to $+85^\circ C$	10	24		
		Sourcing, $V_{CM} = 1.5V$ , $7.5V < V_O < 12.5V$ , $R_L = 600\Omega$		34	300		
		Sinking, $V_{CM} = 1.5V$ , $2.5V < V_O < 7.5V$ , $R_L = 600\Omega$		6	15		



## 5.8 Electrical Characteristics for $V_S = \pm 7.5V$ or $15V$ (続き)

at  $T_J = 25^\circ C$ ,  $V_+ = 15V$ ,  $V_- = 0V$ ,  $V_{CM} = V_{OUT} = V_+ / 2$ , and  $R_L = 1M\Omega$  connected to  $V_+ / 2$  (unless otherwise noted)

PARAMETER		TEST CONDITIONS		MIN	TYP	MAX	UNIT	
<b>FREQUENCY RESPONSE</b>								
GBW	Gain bandwidth product				1.1		MHz	
SR	Slew rate <sup>(1)</sup>	$V_S = 15V, 10V$ step, $R_L = 100k\Omega$ to $7.5V$ $V_{OUT} = 10V_{PP}$ , $f = 1kHz$		0.5	1.1		V/ $\mu s$	
			$T_J = -40^\circ C$ to $+85^\circ C$	0.4	1.1			
$\theta_m$	Phase margin				45		°	
$G_m$	Gain margin				10		dB	
<b>OUTPUT</b>								
$V_O$	Voltage output swing	Positive rail $R_L = 2k\Omega$		14.4	14.7		V	
			$T_J = -40^\circ C$ to $+85^\circ C$	14.2	14.7			
		Negative rail $R_L = 2k\Omega$			0.16	0.32		
			$T_J = -40^\circ C$ to $+85^\circ C$			0.16		0.45
		Positive rail $R_L = 600\Omega$		13.4	14.1			
			$T_J = -40^\circ C$ to $+85^\circ C$	13	14.1			
		Negative rail $R_L = 600\Omega$			0.5	1		
			$T_J = -40^\circ C$ to $+85^\circ C$			0.5		1.3
$I_{SC}$	Short-circuit current <sup>(2)</sup>	Sourcing $V_{OUT} = 0V$		30	50		mA	
			$T_J = -40^\circ C$ to $+85^\circ C$	20	50			
		Sinking $V_{OUT} = 12V$		30	50			
			$T_J = -40^\circ C$ to $+85^\circ C$	20	50			
<b>POWER SUPPLY</b>								
$I_Q$	Quiescent current per amplifier				0.8	1.5	mA	
		$T_J = -40^\circ C$ to $+85^\circ C$			0.8	1.71		

- (1) Number specified is the slower of the positive and negative slew rates.  
(2) Do not short circuit output to  $V_+$  when  $V_+$  is greater than 12V or reliability can be adversely affected.

### 5.9 Typical Characteristics for $V_S = 2.7V$

at  $V_+ = 2.7V$ ,  $V_- = 0V$ , and  $T_A = 25^\circ C$  (unless otherwise specified)

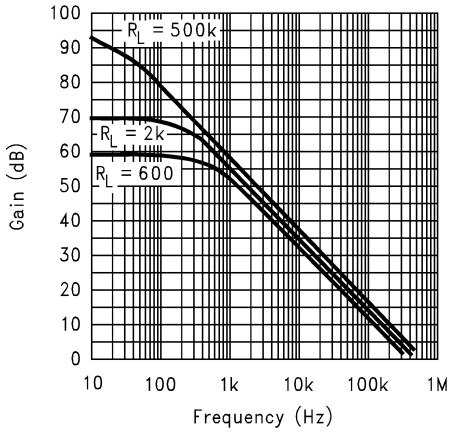

Figure 5-1. Open-Loop Frequency Response

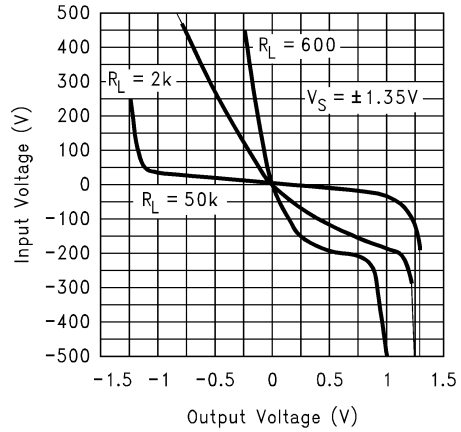

Figure 5-2. Input Voltage vs Output Voltage

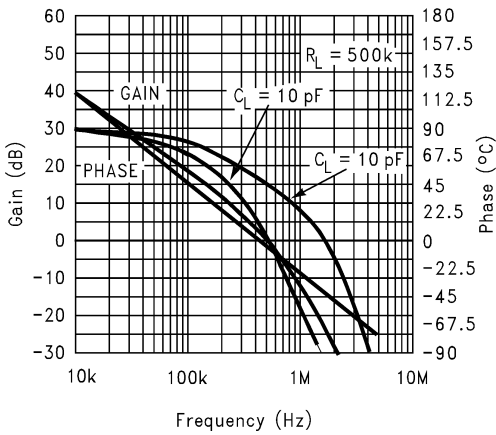

Figure 5-3. Gain and Phase vs Capacitance Load

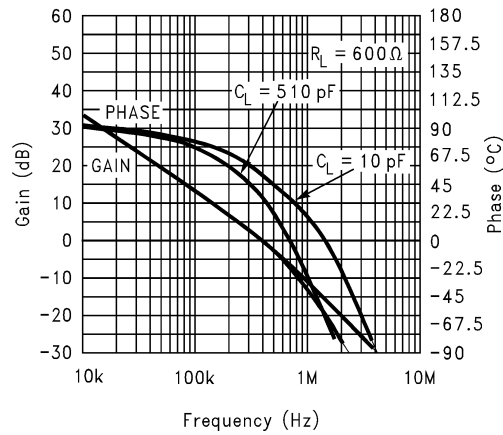

Figure 5-4. Gain and Phase vs Capacitance Load

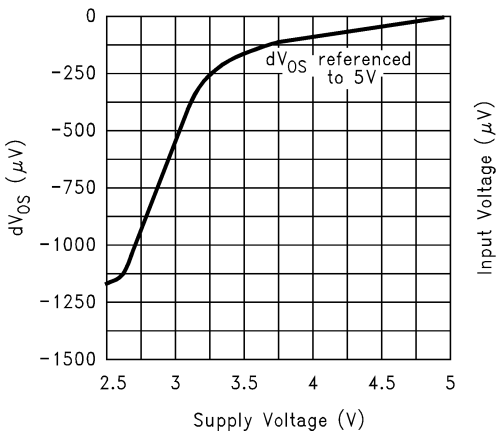

Figure 5-5.  $dV_{OS}$  vs Supply Voltage

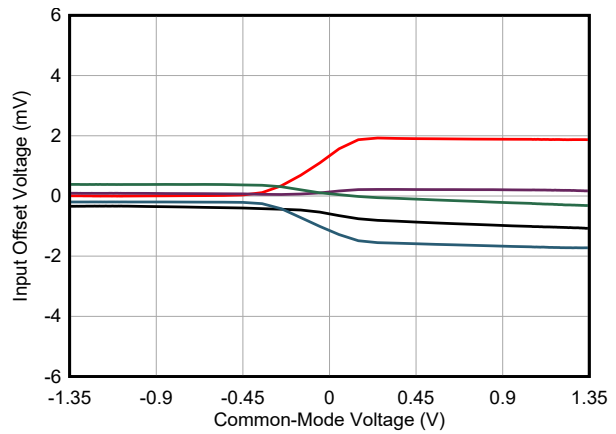
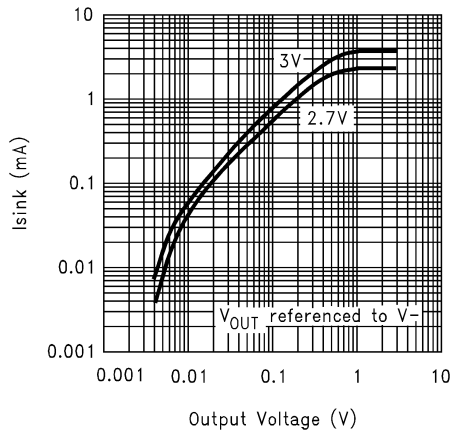

Figure 5-6. Input Offset Voltage vs Common-Mode Voltage

### 5.9 Typical Characteristics for $V_S = 2.7V$ (continued)

at  $V_+ = 2.7V$ ,  $V_- = 0V$ , and  $T_A = 25^\circ C$  (unless otherwise specified)



5-7. Sinking Current vs Output Voltage

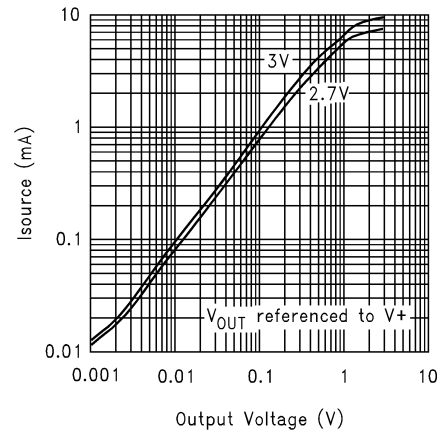

5-8. Sourcing Current vs Output Voltage

### 5.10 Typical Characteristics for $V_S = 3V$

at  $V_+ = 3V$ ,  $V_- = 0V$ , and  $T_A = 25^\circ C$  (unless otherwise specified)

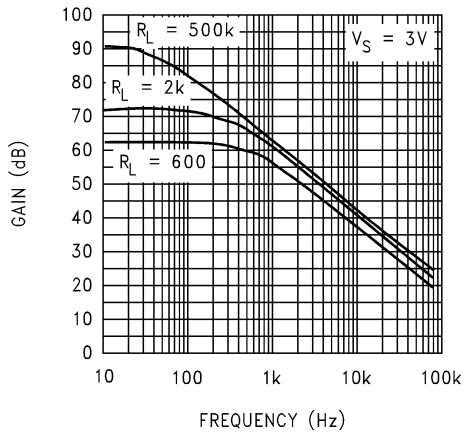

5-9. Open-Loop Frequency Response

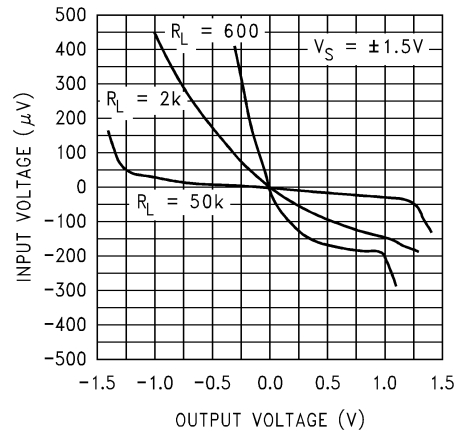

5-10. Input Voltage vs Output Voltage

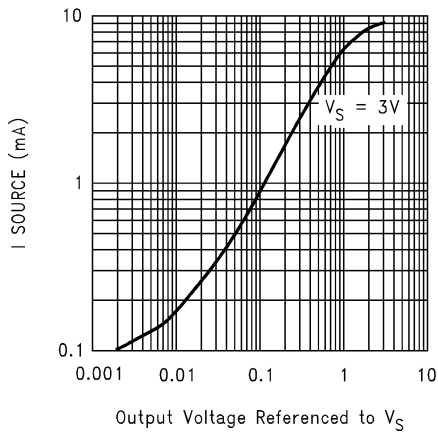

5-11. Sourcing Current vs Output Voltage

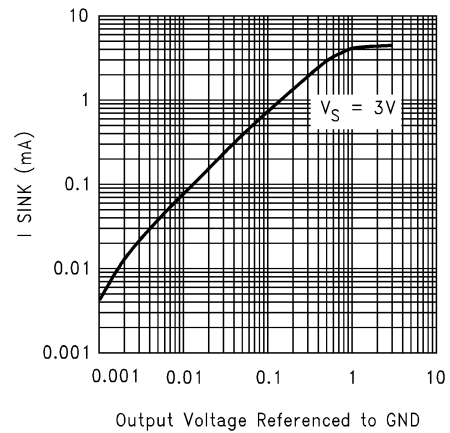

5-12. Sinking Current vs Output Voltage

### 5.11 Typical Characteristics for $V_S = 5V$

at  $V_+ = 5V$ ,  $V_- = 0V$ , and  $T_A = 25^\circ C$  (unless otherwise specified)

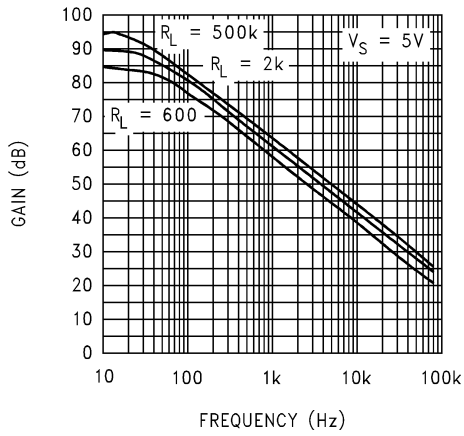

5-13. Open-Loop Frequency Response

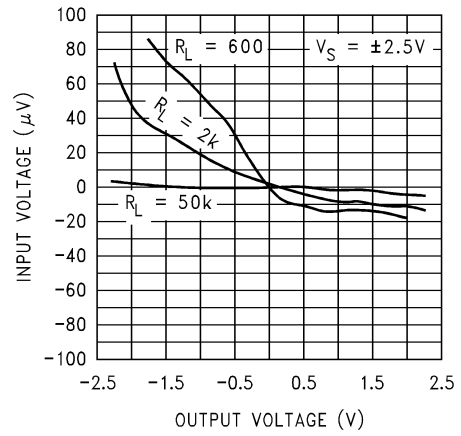

5-14. Input Voltage vs Output Voltage

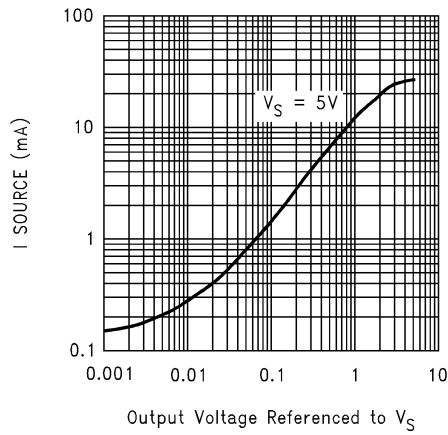

5-15. Sourcing Current vs Output Voltage

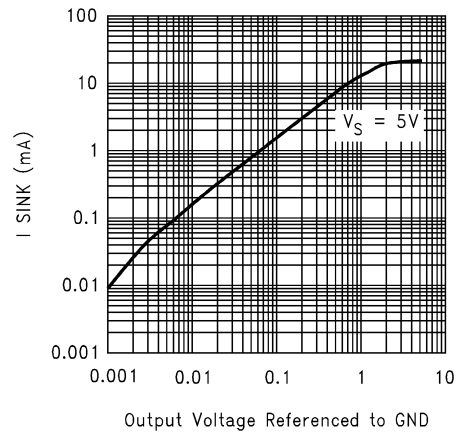

5-16. Sinking Current vs Output Voltage

### 5.12 Typical Characteristics for $V_S = 15V$

at  $V_+ = 15V$ ,  $V_- = 0V$ , and  $T_A = 25^\circ C$  (unless otherwise specified)

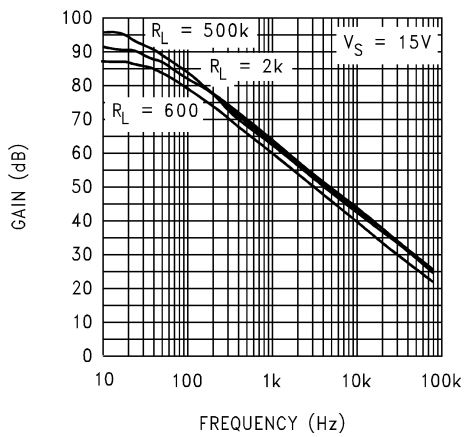

5-17. Open-Loop Frequency Response

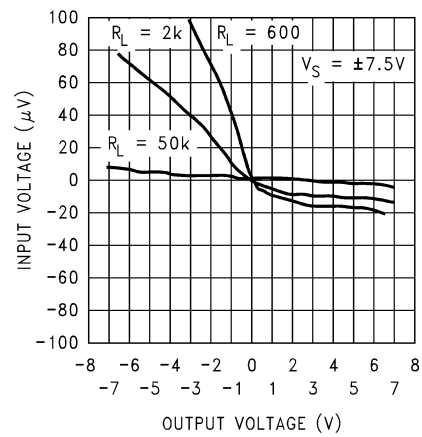

5-18. Input Voltage vs Output Voltage

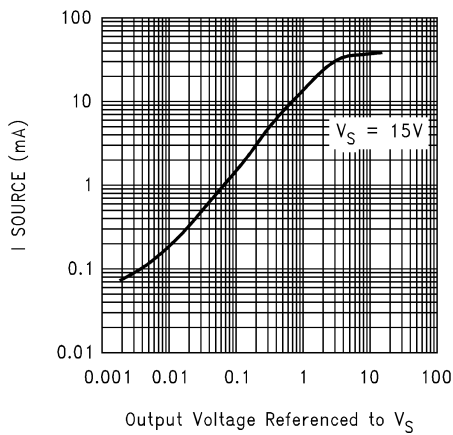

5-19. Sourcing Current vs Output Voltage

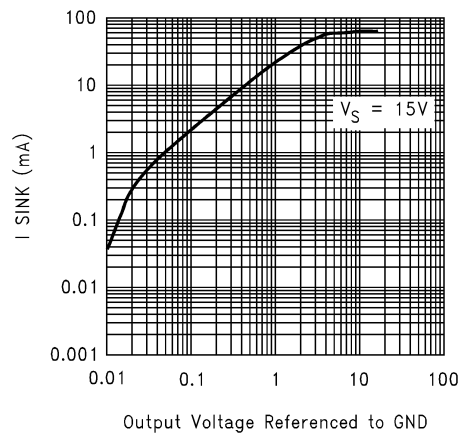

5-20. Sinking Current vs Output Voltage

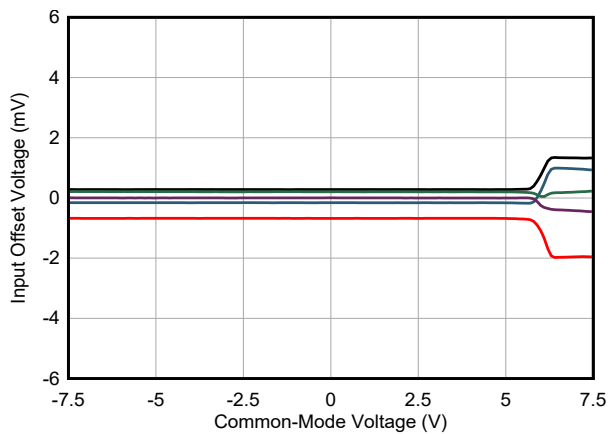

5-21. Input Offset Voltage vs Common-Mode Voltage

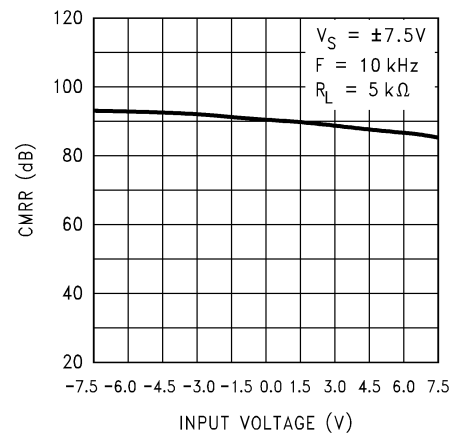

5-22. CMRR vs Input Voltage

### 5.12 Typical Characteristics for $V_S = 15V$ (continued)

at  $V_+ = 15V$ ,  $V_- = 0V$ , and  $T_A = 25^\circ C$  (unless otherwise specified)

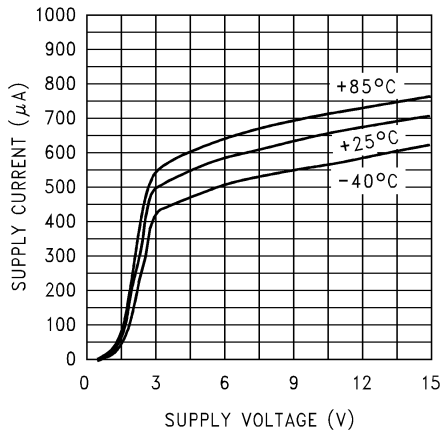

5-23. Supply Current vs Supply Voltage

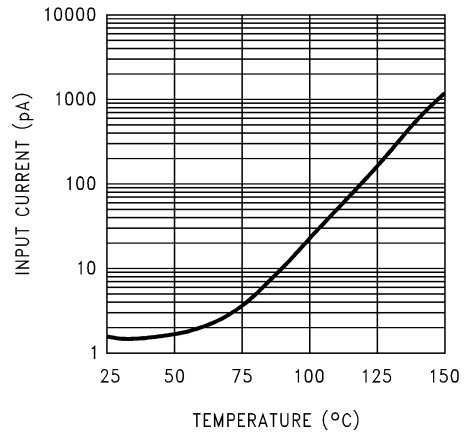

5-24. Input Current vs Temperature

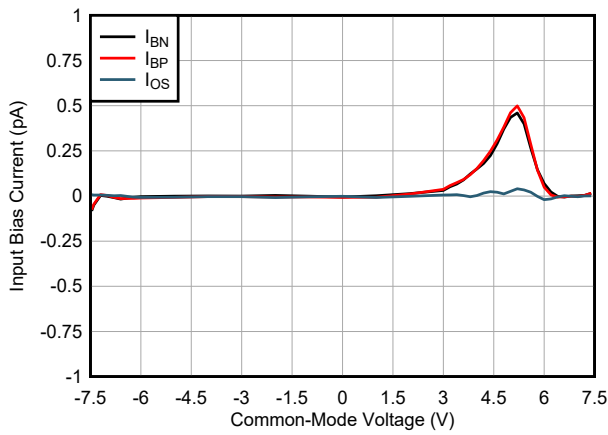

5-25. Input Bias Current vs Common-Mode Voltage

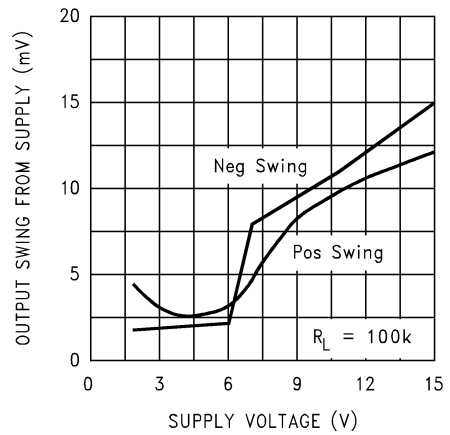

5-26. Output Voltage Swing vs Supply Voltage

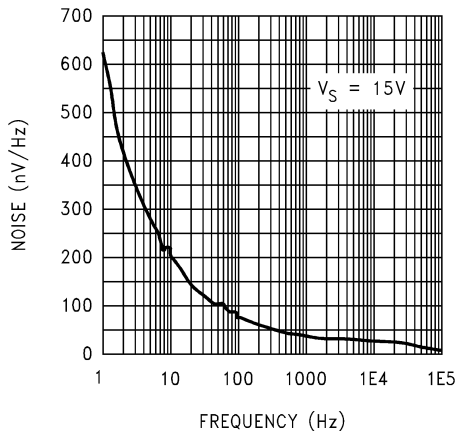

5-27. Input Voltage Noise vs Frequency

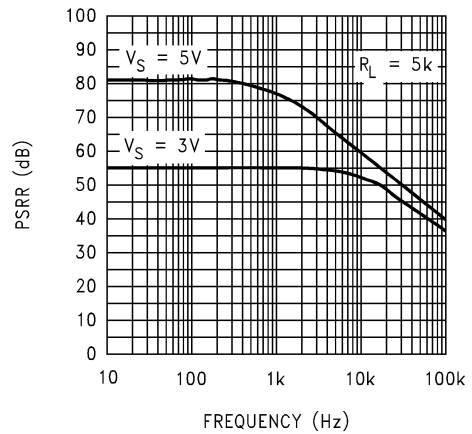

5-28. Positive PSRR vs Frequency

### 5.12 Typical Characteristics for $V_S = 15V$ (continued)

at  $V_+ = 15V$ ,  $V_- = 0V$ , and  $T_A = 25^\circ C$  (unless otherwise specified)

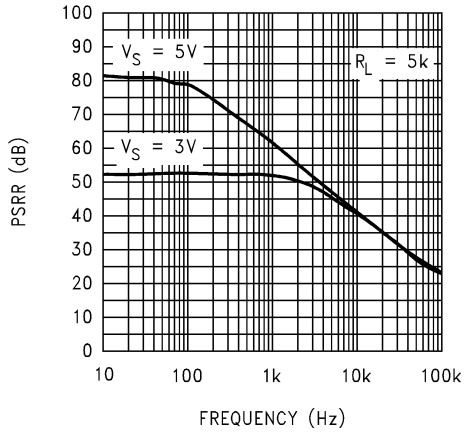

5-29. Negative PSRR vs Frequency

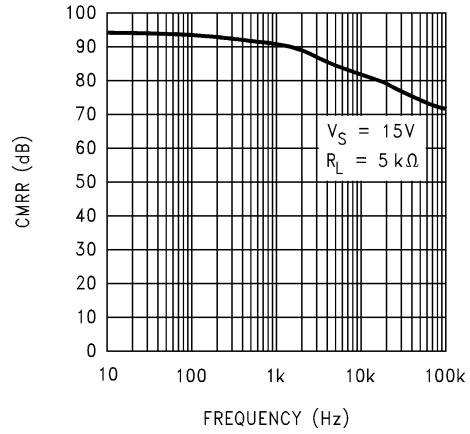

5-30. CMRR vs Frequency

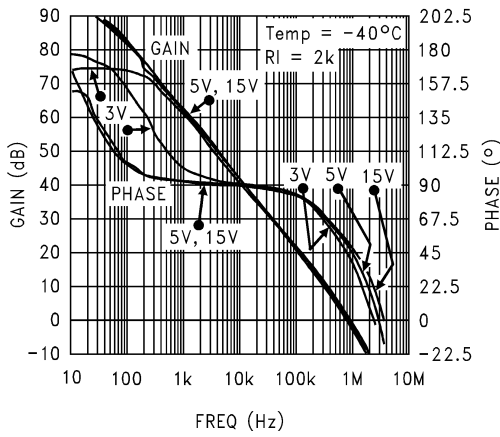

5-31. Open-Loop Frequency Response at  $-40^\circ C$

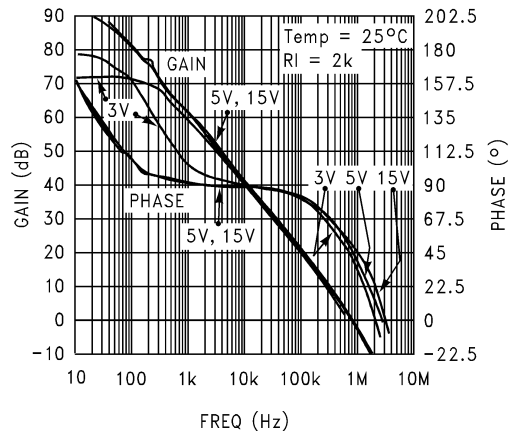

5-32. Open-Loop Frequency Response at  $25^\circ C$

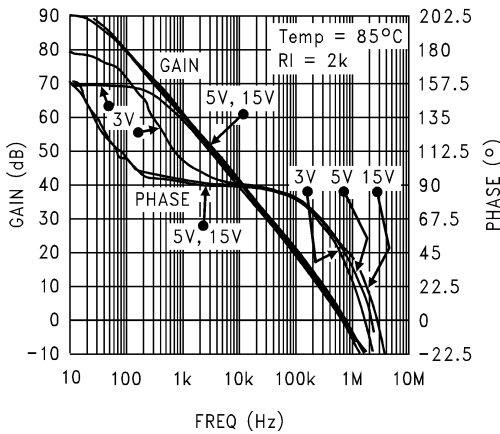

5-33. Open-Loop Frequency Response at  $85^\circ C$

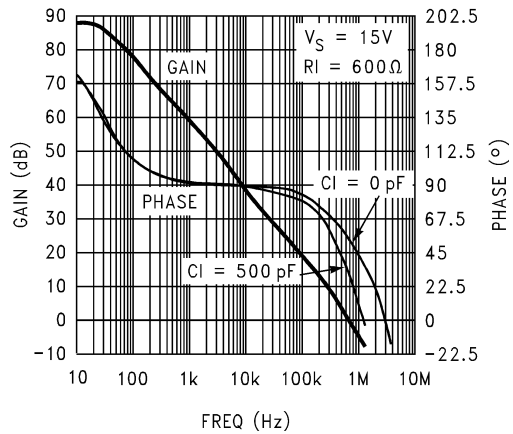

5-34. Gain and Phase vs Capacitive Load



### 5.12 Typical Characteristics for $V_S = 15V$ (continued)

at  $V_+ = 15V$ ,  $V_- = 0V$ , and  $T_A = 25^\circ C$  (unless otherwise specified)

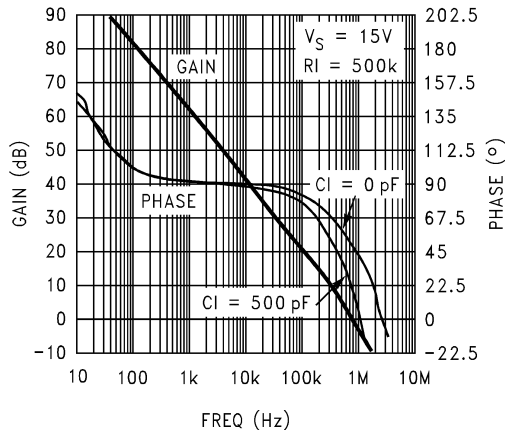

5-35. Gain and Phase vs Capacitive Load

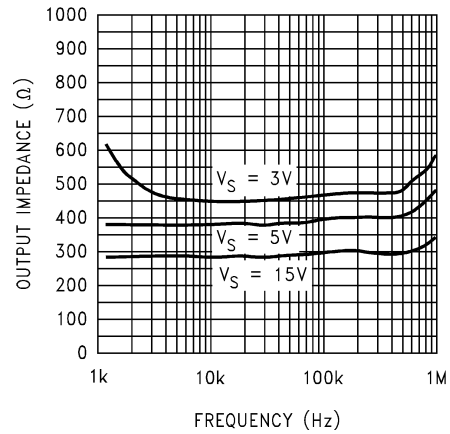

5-36. Output Impedance vs Frequency

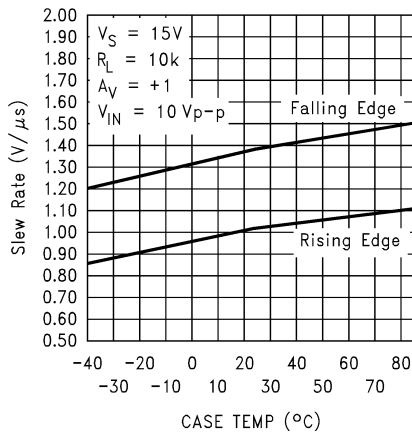

5-37. Slew Rate vs Temperature

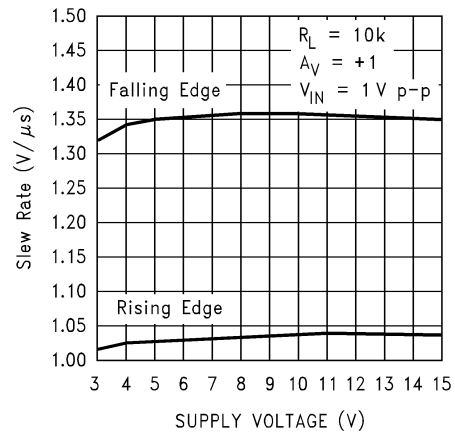

5-38. Slew Rate vs Supply Voltage

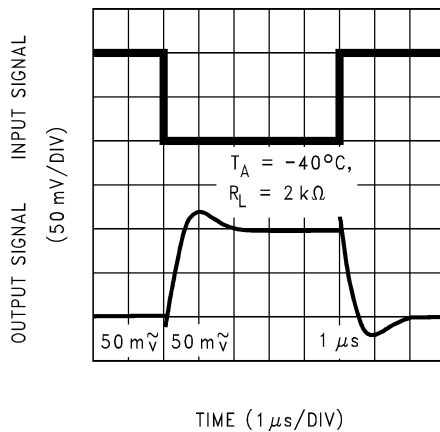

5-39. Inverting Small-Signal Pulse Response

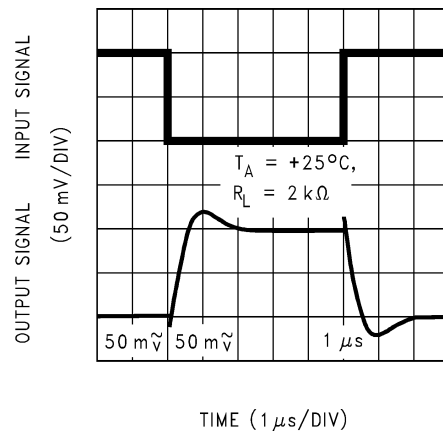

5-40. Inverting Small-Signal Pulse Response

### 5.12 Typical Characteristics for $V_S = 15V$ (continued)

at  $V_+ = 15V$ ,  $V_- = 0V$ , and  $T_A = 25^\circ C$  (unless otherwise specified)

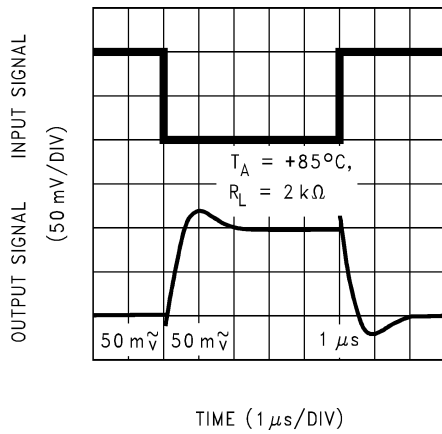

5-41. Inverting Small-Signal Pulse Response

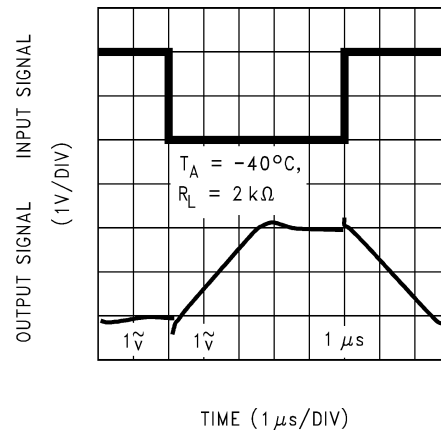

5-42. Inverting Large-Signal Pulse Response

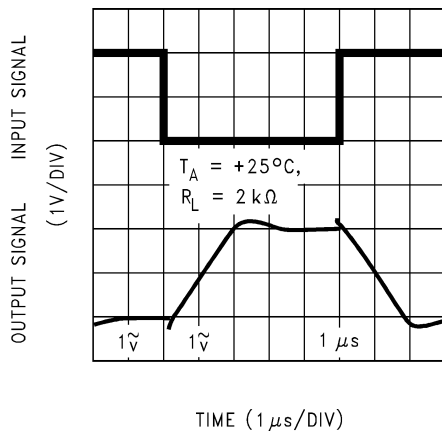

5-43. Inverting Large-Signal Pulse Response

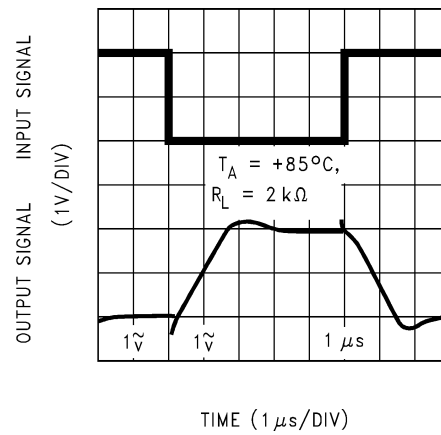

5-44. Inverting Large-Signal Pulse Response

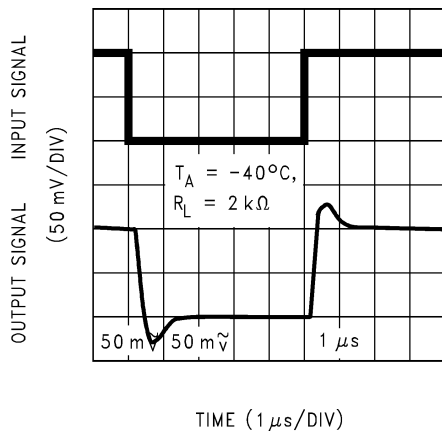

5-45. Noninverting Small-Signal Pulse Response

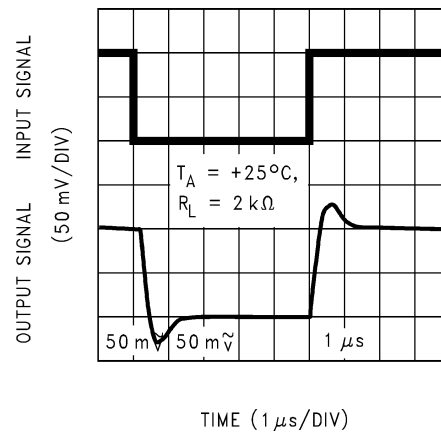

5-46. Noninverting Small-Signal Pulse Response

### 5.12 Typical Characteristics for $V_S = 15V$ (continued)

at  $V_+ = 15V$ ,  $V_- = 0V$ , and  $T_A = 25^\circ C$  (unless otherwise specified)

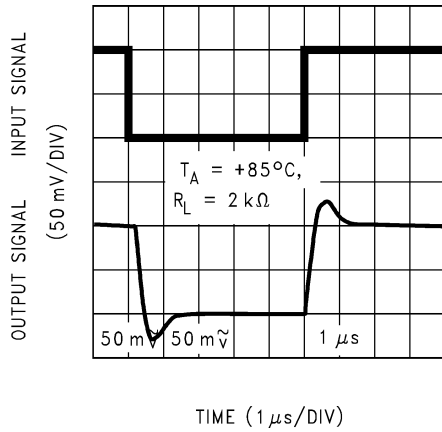

5-47. Noninverting Small-Signal Pulse Response

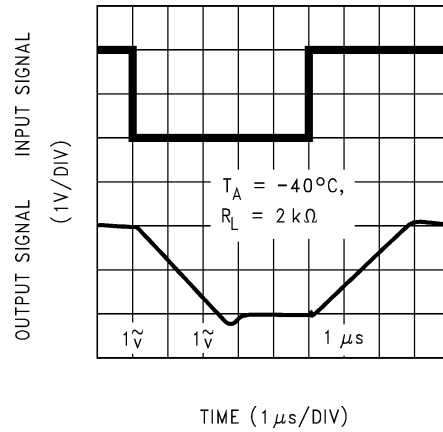

5-48. Noninverting Large-Signal Pulse Response

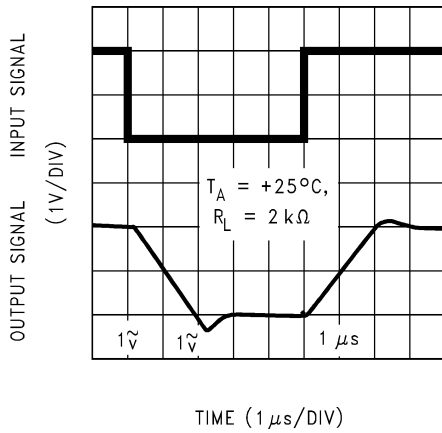

5-49. Noninverting Large-Signal Pulse Response

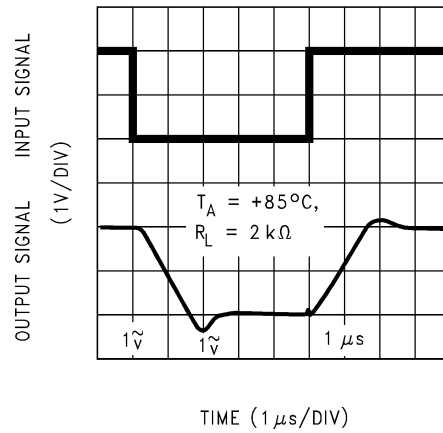

5-50. Noninverting Large-Signal Pulse Response

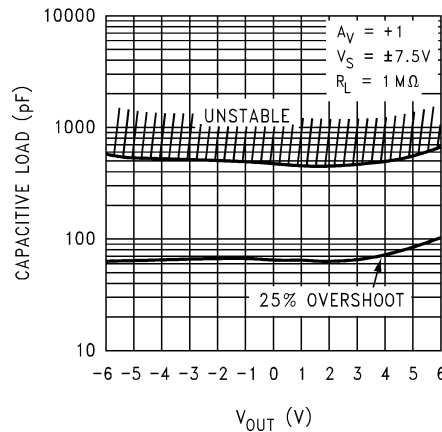

5-51. Stability vs Capacitive Load

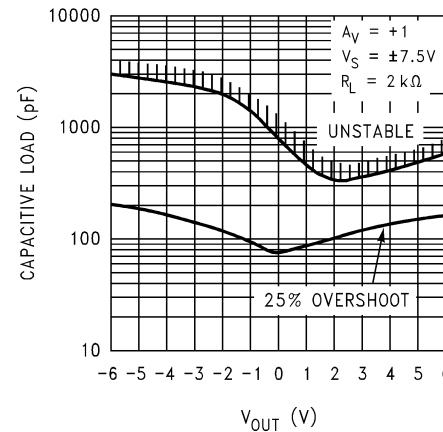

5-52. Stability vs Capacitive Load

### 5.12 Typical Characteristics for $V_S = 15V$ (continued)

at  $V_+ = 15V$ ,  $V_- = 0V$ , and  $T_A = 25^\circ C$  (unless otherwise specified)



图 5-53. Stability vs Capacitive Load



图 5-54. Stability vs Capacitive Load

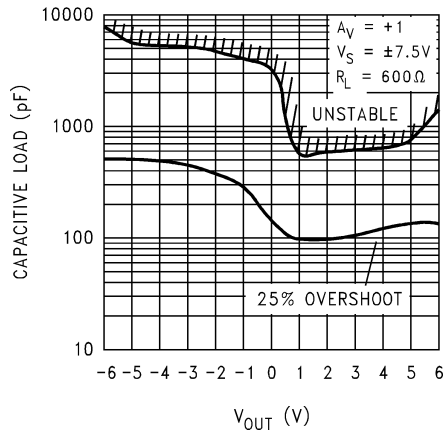

图 5-55. Stability vs Capacitive Load

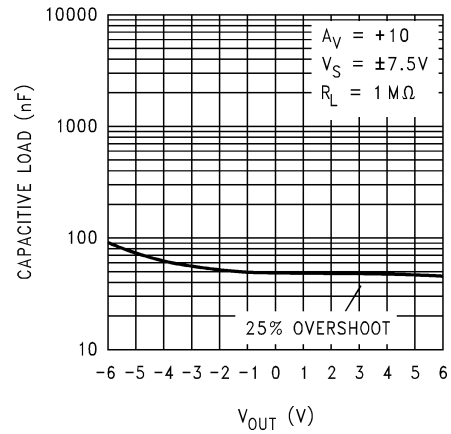

图 5-56. Stability vs Capacitive Load

## 6 Detailed Description

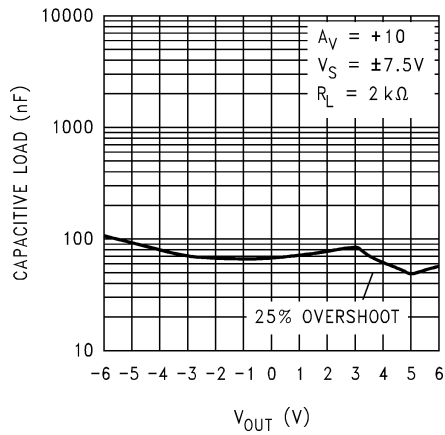
### 6.1 Overview

The LMC7101 is a single-channel, low-power operational amplifier available in a space-saving SOT-23 package, offering rail-to-rail input and output operation across a wide range of power-supply configurations.

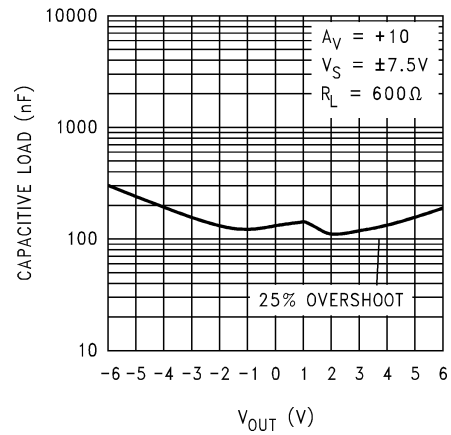
The LMC7101 is also available in an automotive-grade variant, see LMC7101Q-Q1.

### 6.2 Functional Block Diagram

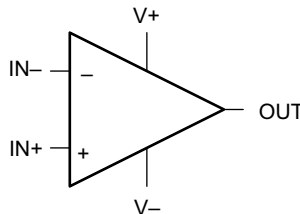

### 6.3 Feature Description

#### 6.3.1 Benefits of the LMC7101 Tiny Amplifier

##### 6.3.1.1 Size

The small footprint of the SOT-23-5 packaged tiny amplifier, (0.12in × 0.118in, 3.05mm × 3mm) saves space on printed circuit boards, and enable the design of smaller electronic products. Many customers prefer smaller and lighter products because the designs can contribute to overall weight reduction in portable electronics.

##### 6.3.1.2 Height

The 0.056 inches (1.43mm) height of the tiny LMC7101 amplifier makes the device an excellent choice for use in a wide range of circuit boards in which a thin profile is required.

##### 6.3.1.3 Signal Integrity

Signals can pick up noise between the signal source and the amplifier. By using a physically smaller amplifier package, the tiny amplifier can be placed closer to the signal source, thus reducing noise pickup and increasing signal integrity. The tiny amplifier can also be placed next to the signal destination, such as a buffer, for the reference of an analog-to-digital converter.

##### 6.3.1.4 Simplified Board Layout

The tiny LMC7101 amplifier can simplify board layout in several ways. Avoid long PCB traces by correctly placing amplifiers instead of routing signals to a dual or quad device. By using multiple tiny amplifiers instead of duals or quads, complex signal routing and possibly crosstalk can be reduced.

##### 6.3.1.5 Low THD

The high open-loop gain of the LMC7101 amplifier helps to achieve very low audio distortion—typically 0.01% at 10kHz with a 10kΩ load at 5V supplies. This makes the tiny amplifier an excellent choice for audio and low-frequency signal-processing applications.

##### 6.3.1.6 Low Supply Current

The typical 0.5mA supply current of the LMC7101 can help improve thermal performance on high density circuit boards, and can allow the reduction of the overall board size in some applications.

##### 6.3.1.7 Wide Voltage Range

The LMC7101 is characterized at 15V, 5V and 3V. Performance data is provided at these popular voltages. This wide voltage range makes the LMC7101 a good choice for devices where the supply voltage can vary.

## 6.4 Device Functional Modes

### 6.4.1 Input Common Mode

#### 6.4.1.1 Input Common-Mode Voltage Range

The LMC7101 does not exhibit phase inversion when an input voltage exceeds the negative supply voltage. [Figure 6-1](#) shows an input voltage exceeding both supplies with no resulting phase inversion of the output.

The absolute maximum input voltage is 300mV beyond either rail at room temperature. Voltages greatly exceeding this maximum rating, as in [Figure 6-2](#), can cause excessive current to flow in or out of the input pins, thus adversely affecting reliability.

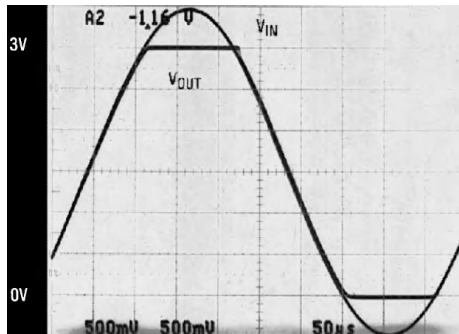

The input voltage signal exceeds the amplifier power supply voltage with no output phase inversion.

**Figure 6-1. Input Voltage**

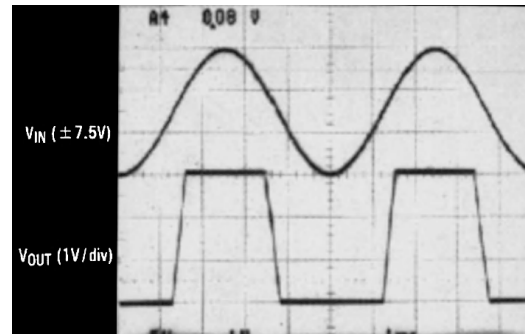

The  $\pm 7.5\text{V}$  input signal greatly exceeds the 3V supply in [Figure 6-3](#) causing no phase inversion due to  $R_i$ .

**Figure 6-2. Input Signal**

Applications that exceed this rating must externally limit the maximum input current to  $\pm 5\text{mA}$  with an input resistor as shown in [Figure 6-3](#).

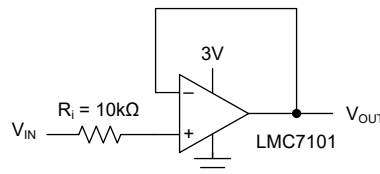

**Figure 6-3.  $R_i$  Input Current Protection for Voltages Exceeding the Supply Voltage**

## 7 Application and Implementation

### 注

以下のアプリケーション情報は、TI の製品仕様に含まれるものではなく、TI ではその正確性または完全性を保証いたしません。個々の目的に対する製品の適合性については、お客様の責任で判断していただくこととなります。お客様は自身の設計実装を検証しテストすることで、システムの機能を確認する必要があります。

### 7.1 Application Information

#### 7.1.1 Rail-to-Rail Output

The approximate output resistance of the LMC7101 is  $180\Omega$  sourcing and  $130\Omega$  sinking at  $V_S = 3V$  and  $110\Omega$  sourcing and  $80\Omega$  sinking at  $V_S = 5V$ . Using the calculated output resistance, maximum output voltage swing can be estimated as a function of load.

#### 7.1.2 Capacitive Load Tolerance

The LMC7101 can typically directly drive a  $100\text{pF}$  load with  $V_S = 15V$  at unity gain without oscillating. The unity gain follower is the most sensitive configuration. Direct capacitive loading reduces the phase margin of operational amplifiers. The combination of the output impedance and the capacitive load of the operational amplifier induces phase lag, which results in either an underdamped pulse response or oscillation.

Capacitive load compensation can be accomplished using resistive isolation as shown in [図 7-1](#). This simple technique is useful for isolating the capacitive input of multiplexers and A/D converters.

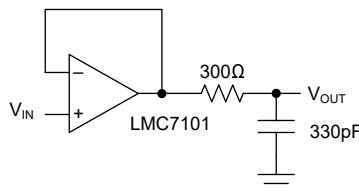

**図 7-1. Resistive Isolation of a 330pF Capacitive Load**

### 7.1.3 Compensating for Input Capacitance When Using Large Value Feedback Resistors

When using very large value feedback resistors, (usually >500 kΩ) the large feedback resistance can react with the input capacitance due to transducers, photo diodes, and circuit board parasitics to reduce phase margins.

The effect of input capacitance can be compensated for by adding a feedback capacitor. The feedback capacitor (as in [Figure 7-2](#)),  $C_f$  is first estimated by [Equation 1](#) and [Equation 2](#), which typically provides significant overcompensation.

$$\frac{1}{2\pi R_1 C_{IN}} \geq \frac{1}{2\pi R_2 C_f} \quad (1)$$

$$2\pi R_1 C_{IN} \leq 2\pi R_2 C_f \quad (2)$$

Printed circuit board stray capacitance can be larger or smaller than that of a breadboard, so the actual optimum value for  $C_f$  can be different. The values of  $C_f$  must be checked on the actual circuit.

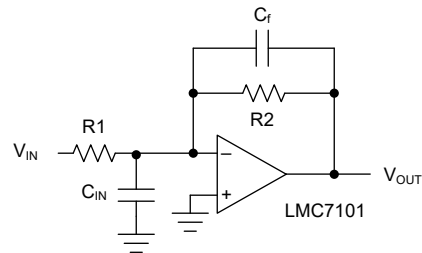

**Figure 7-2. Canceling the Effect of Input Capacitance**

## 7.2 Typical Application

[Figure 7-3](#) shows a high input impedance noninverting circuit. This circuit gives a closed-loop gain equal to the ratio of the sum of  $R_1$  and  $R_2$  to  $R_1$  and a closed-loop 3dB bandwidth equal to the amplifier unity-gain frequency divided by the closed-loop gain. This design has the benefit of a very high input impedance, which is equal to the differential input impedance multiplied by loop gain (open loop gain / closed loop gain). In dc-coupled applications, input impedance is not as important as input current and the voltage drop across the source resistance. The amplifier output can go into saturation if the input is allowed to float, which can be important if the amplifier must be switched from source to source.

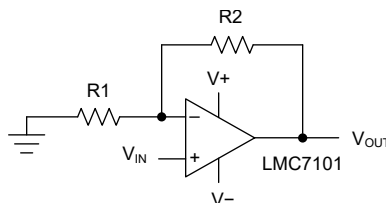

**Figure 7-3. Example Application**



### 7.2.1 Design Requirements

For this example application, the supply voltage is 5V, and  $100 \times \pm 5\%$  of noninverting gain is necessary. The signal input impedance is approximately 10k $\Omega$ .

### 7.2.2 Detailed Design Procedure

Use the equation for a noninverting amplifier configuration;  $G = 1 + R_2 / R_1$ , set  $R_1$  to 10k $\Omega$ , and  $R_2$  to  $99 \times R_1$ , which is 990k $\Omega$ . Replacing the 990k $\Omega$  resistor with a more readily available 1M $\Omega$  resistor results in a gain of 101, which is within the desired gain tolerance. The gain-frequency characteristic of the amplifier and the feedback network must be such that oscillation does not occur. To meet this condition, the phase shift through amplifier and feedback network must never exceed 180° for any frequency where the gain of the amplifier and the feedback network is greater than unity. In practical applications, the phase shift must not approach 180° because this is the situation of conditional stability. The most critical case occurs when the attenuation of the feedback network is zero.

### 7.2.3 Application Curve

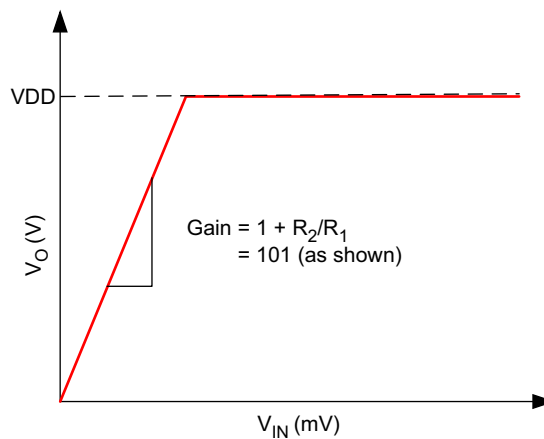

☒ 7-4. Output Response

## 7.3 Power Supply Recommendations

For proper operation, the power supplies must be decoupled. For supply decoupling, TI recommends placing 10nF to 1 $\mu$ F capacitors as close as possible to the operational-amplifier power supply pins. For single supply configurations, place a capacitor between the V+ and V– supply pins. For dual supply configurations, place one capacitor between V+ and ground, and place a second capacitor between V– and ground. Bypass capacitors must have a low ESR of less than 0.1 $\Omega$ .

## 7.4 Layout

### 7.4.1 Layout Guidelines

Care must be taken to minimize the loop area formed by the bypass capacitor connection between supply pins and ground. A ground plane underneath the device is recommended; any bypass components to ground must have a nearby via to the ground plane. The optimum bypass capacitor placement is closest to the corresponding supply pin. Use of thicker traces from the bypass capacitors to the corresponding supply pins can lower the power-supply inductance and provide a more stable power supply.

The feedback components must be placed as close as possible to the device to minimize stray parasitics.

### 7.4.2 Layout Example

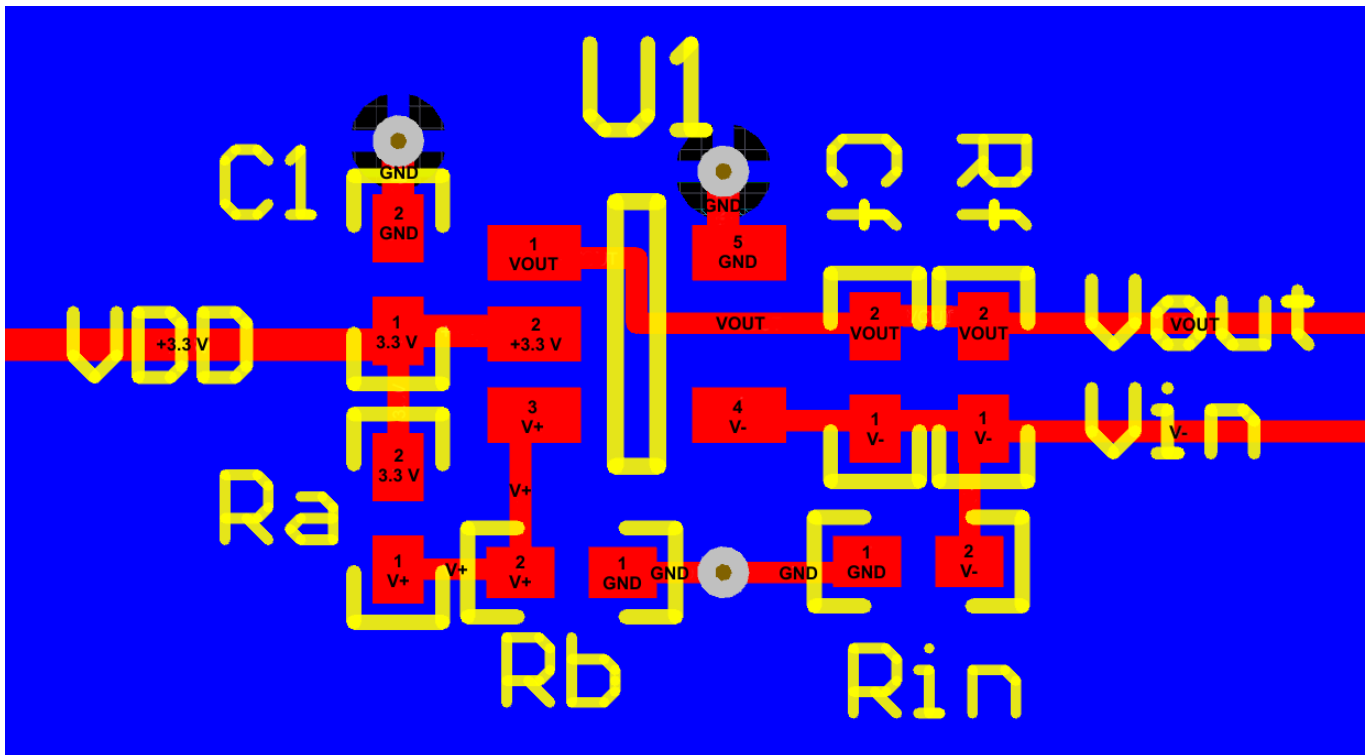

☒ 7-5. LMC7101 Example Layout

## 8 Device and Documentation Support

### 8.1 Documentation Support

#### 8.1.1 Related Documentation

For related documentation, see the following:

- Texas Instruments, [LMC66x CMOS Dual Operational Amplifiers data sheet](#)
- Texas Instruments, [RES11A Matched, Thin-Film Resistor Dividers With 1kΩ Inputs data sheet](#)

### 8.2 ドキュメントの更新通知を受け取る方法

ドキュメントの更新についての通知を受け取るには、[www.tij.co.jp](http://www.tij.co.jp) のデバイス製品フォルダを開いてください。[通知] をクリックして登録すると、変更されたすべての製品情報に関するダイジェストを毎週受け取ることができます。変更の詳細については、改訂されたドキュメントに含まれている改訂履歴をご覧ください。

### 8.3 サポート・リソース

テキサス・インスツルメンツ E2E™ サポート・フォーラムは、エンジニアが検証済みの回答と設計に関するヒントをエキスパートから迅速かつ直接得ることができる場所です。既存の回答を検索したり、独自の質問をしたりすることで、設計に必要な支援を迅速に得ることができます。

リンクされているコンテンツは、各寄稿者により「現状のまま」提供されるものです。これらはテキサス・インスツルメンツの仕様を構成するものではなく、必ずしもテキサス・インスツルメンツの見解を反映したものではありません。テキサス・インスツルメンツの[使用条件](#)を参照してください。

### 8.4 Trademarks

テキサス・インスツルメンツ E2E™ is a trademark of Texas Instruments.  
すべての商標は、それぞれの所有者に帰属します。

### 8.5 静電気放電に関する注意事項



この IC は、ESD によって破損する可能性があります。テキサス・インスツルメンツは、IC を取り扱う際には常に適切な注意を払うことを推奨します。正しい取り扱いおよび設置手順に従わない場合、デバイスを破損するおそれがあります。

ESD による破損は、わずかな性能低下からデバイスの完全な故障まで多岐にわたります。精密な IC の場合、パラメータがわずかに変化するだけで公表されている仕様から外れる可能性があるため、破損が発生しやすくなっています。

### 8.6 用語集

[テキサス・インスツルメンツ用語集](#) この用語集には、用語や略語の一覧および定義が記載されています。

## 9 Revision History

資料番号末尾の英字は改訂を表しています。その改訂履歴は英語版に準じています。

Changes from Revision SNOS719G (September 2015) to Revision * (January 2025)	Page
• LMC7101 商用デバイスを SNOS719G データシートから新しい SBOSAL2 データシートに移動.....	1
• 「特長」を更新 .....	1
• Deleted machine model (MM) in <i>ESD Ratings</i> .....	3
• Updated <i>Thermal Information</i> .....	3
• Updated parameter names and table format in all <i>Electrical Characteristics</i> .....	4
• Added missing temperature range for input offset voltage drift in all <i>Electrical Characteristics</i> .....	4
• Changed power-supply rejection ratio from 50dB to 45dB for LMC7101A.....	4
• Changed power-supply rejection ratio from 50dB to 45dB for LMC7101A.....	4
• Changed input common-mode voltage condition from CMRR ≥ 50dB to CMRR ≥ 47dB.....	4
• Changed CMRR MIN from 50dB to 47dB for LMC7101B and from 55dB to 47dB for LMC7101A.....	4
• Deleted notes 1 and 2 in all <i>Electrical Characteristics</i> .....	4
• Updated note 3 to move information into slew rate test conditions.....	4

• Changed input common-mode voltage condition from CMRR > 50dB to CMRR > 47dB.....	5
• Changed CMRR MIN from 60dB to 47dB for LMC7101B and from 64dB to 47dB for LMC7101A.....	5
• Added missing quiescent current per amplifier TYP value.....	5
• Changed CMRR TYP from 82dB to 75dB.....	6
• Changed CMRR MIN from 60dB to 52dB for LMC7101B and from 65dB to 52dB for LMC7101A.....	6
• Changed CMRR MIN for T <sub>J</sub> = –40°C to +85°C from 55dB to 51dB for LMC7101B and from 60dB to 51dB for LMC7101A.....	6
• Changed CMRR TYP for T <sub>J</sub> = –40C to +85C from 82dB to 74dB.....	6
• Changed input offset voltage TYP from 0.11mV to 0.26mV.....	8
• Changed CMRR MIN from 65dB to 62dB for LMC7101B and from 70dB to 62dB for LMC7101A.....	8
• Changed CMRR MIN for T <sub>J</sub> = –40°C to +85°C from 65dB to 60dB LMC7101A.....	8
• Deleted note 3 and included information to open-loop voltage gain test conditions.....	8
• Deleted Figures 6, 11, 14, 17, 20, 23, and 37.....	10
• Added Figure 5-6.....	10
• Added Figures 5-21 and 5-25.....	14

## 10 Mechanical, Packaging, and Orderable Information

The following pages include mechanical, packaging, and orderable information. This information is the most current data available for the designated devices. This data is subject to change without notice and revision of this document. For browser-based versions of this data sheet, refer to the left-hand navigation.

## 重要なお知らせと免責事項

テキサス・インスツルメンツは、技術データと信頼性データ (データシートを含みます)、設計リソース (リファレンス デザインを含みます)、アプリケーションや設計に関する各種アドバイス、Web ツール、安全性情報、その他のリソースを、欠陥が存在する可能性のある「現状のまま」提供しており、商品性および特定目的に対する適合性の黙示保証、第三者の知的財産権の非侵害保証を含むいかなる保証も、明示的または黙示的にかかわらず拒否します。

これらのリソースは、テキサス・インスツルメンツ製品を使用する設計の経験を積んだ開発者への提供を意図したものです。(1) お客様のアプリケーションに適した テキサス・インスツルメンツ製品の選定、(2) お客様のアプリケーションの設計、検証、試験、(3) お客様のアプリケーションに該当する各種規格や、その他のあらゆる安全性、セキュリティ、規制、または他の要件への確実な適合に関する責任を、お客様のみが単独で負うものとします。

上記の各種リソースは、予告なく変更される可能性があります。これらのリソースは、リソースで説明されている テキサス・インスツルメンツ製品を使用するアプリケーションの開発の目的でのみ、テキサス・インスツルメンツはその使用をお客様に許諾します。これらのリソースに関して、他の目的で複製することや掲載することは禁止されています。テキサス・インスツルメンツや第三者の知的財産権のライセンスが付与されている訳ではありません。お客様は、これらのリソースを自身で使用した結果発生するあらゆる申し立て、損害、費用、損失、責任について、テキサス・インスツルメンツおよびその代理人を完全に補償するものとし、テキサス・インスツルメンツは一切の責任を拒否します。

テキサス・インスツルメンツの製品は、[テキサス・インスツルメンツの販売条件](#)、または [ti.com](https://www.ti.com) やかかる テキサス・インスツルメンツ製品の関連資料などのいずれかを通じて提供する適用可能な条項の下で提供されています。テキサス・インスツルメンツがこれらのリソースを提供することは、適用されるテキサス・インスツルメンツの保証または他の保証の放棄の拡大や変更を意味するものではありません。

お客様がいかなる追加条項または代替条項を提案した場合でも、テキサス・インスツルメンツはそれらに異議を唱え、拒否します。

郵送先住所: Texas Instruments, Post Office Box 655303, Dallas, Texas 75265

Copyright © 2025, Texas Instruments Incorporated

**PACKAGING INFORMATION**

Orderable Device	Status (1)	Package Type	Package Drawing	Pins	Package Qty	Eco Plan (2)	Lead finish/ Ball material (6)	MSL Peak Temp (3)	Op Temp (°C)	Device Marking (4/5)	Samples
LMC7101AIM5/NOPB	OBSOLETE	SOT-23	DBV	5		TBD	Call TI	Call TI	-40 to 85	A00A	
LMC7101AIM5X/NOPB	ACTIVE	SOT-23	DBV	5	3000	RoHS & Green	NIPDAU   SN	Level-1-260C-UNLIM	-40 to 85	A00A	Samples
LMC7101BIM5/NOPB	OBSOLETE	SOT-23	DBV	5		TBD	Call TI	Call TI	-40 to 85	A00B	
LMC7101BIM5X/NOPB	ACTIVE	SOT-23	DBV	5	3000	RoHS & Green	NIPDAU   SN	Level-1-260C-UNLIM	-40 to 85	A00B	Samples

(1) The marketing status values are defined as follows:

**ACTIVE:** Product device recommended for new designs.

**LIFEBUY:** TI has announced that the device will be discontinued, and a lifetime-buy period is in effect.

**NRND:** Not recommended for new designs. Device is in production to support existing customers, but TI does not recommend using this part in a new design.

**PREVIEW:** Device has been announced but is not in production. Samples may or may not be available.

**OBSOLETE:** TI has discontinued the production of the device.

(2) **RoHS:** TI defines "RoHS" to mean semiconductor products that are compliant with the current EU RoHS requirements for all 10 RoHS substances, including the requirement that RoHS substance do not exceed 0.1% by weight in homogeneous materials. Where designed to be soldered at high temperatures, "RoHS" products are suitable for use in specified lead-free processes. TI may reference these types of products as "Pb-Free".

**RoHS Exempt:** TI defines "RoHS Exempt" to mean products that contain lead but are compliant with EU RoHS pursuant to a specific EU RoHS exemption.

**Green:** TI defines "Green" to mean the content of Chlorine (Cl) and Bromine (Br) based flame retardants meet JS709B low halogen requirements of <=1000ppm threshold. Antimony trioxide based flame retardants must also meet the <=1000ppm threshold requirement.

(3) MSL, Peak Temp. - The Moisture Sensitivity Level rating according to the JEDEC industry standard classifications, and peak solder temperature.

(4) There may be additional marking, which relates to the logo, the lot trace code information, or the environmental category on the device.

(5) Multiple Device Markings will be inside parentheses. Only one Device Marking contained in parentheses and separated by a "~" will appear on a device. If a line is indented then it is a continuation of the previous line and the two combined represent the entire Device Marking for that device.

(6) Lead finish/Ball material - Orderable Devices may have multiple material finish options. Finish options are separated by a vertical ruled line. Lead finish/Ball material values may wrap to two lines if the finish value exceeds the maximum column width.

**Important Information and Disclaimer:**The information provided on this page represents TI's knowledge and belief as of the date that it is provided. TI bases its knowledge and belief on information provided by third parties, and makes no representation or warranty as to the accuracy of such information. Efforts are underway to better integrate information from third parties. TI has taken and continues to take reasonable steps to provide representative and accurate information but may not have conducted destructive testing or chemical analysis on incoming materials and chemicals. TI and TI suppliers consider certain information to be proprietary, and thus CAS numbers and other limited information may not be available for release.

In no event shall TI's liability arising out of such information exceed the total purchase price of the TI part(s) at issue in this document sold by TI to Customer on an annual basis.

# DBV0005A



# PACKAGE OUTLINE

SOT-23 - 1.45 mm max height

SMALL OUTLINE TRANSISTOR



4214839/K 08/2024

## NOTES:

1. All linear dimensions are in millimeters. Any dimensions in parenthesis are for reference only. Dimensioning and tolerancing per ASME Y14.5M.
2. This drawing is subject to change without notice.
3. Reference JEDEC MO-178.
4. Body dimensions do not include mold flash, protrusions, or gate burrs. Mold flash, protrusions, or gate burrs shall not exceed 0.25 mm per side.
5. Support pin may differ or may not be present.



# EXAMPLE BOARD LAYOUT

DBV0005A

SOT-23 - 1.45 mm max height

SMALL OUTLINE TRANSISTOR



LAND PATTERN EXAMPLE  
EXPOSED METAL SHOWN  
SCALE:15X

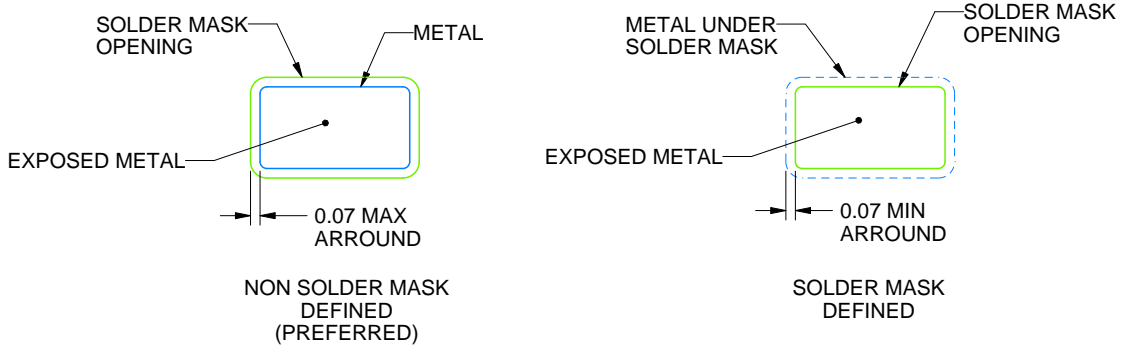

SOLDER MASK DETAILS

4214839/K 08/2024

NOTES: (continued)

- 6. Publication IPC-7351 may have alternate designs.
- 7. Solder mask tolerances between and around signal pads can vary based on board fabrication site.

# EXAMPLE STENCIL DESIGN

DBV0005A

SOT-23 - 1.45 mm max height

SMALL OUTLINE TRANSISTOR



SOLDER PASTE EXAMPLE  
BASED ON 0.125 mm THICK STENCIL  
SCALE:15X

4214839/K 08/2024

NOTES: (continued)

8. Laser cutting apertures with trapezoidal walls and rounded corners may offer better paste release. IPC-7525 may have alternate design recommendations.
9. Board assembly site may have different recommendations for stencil design.

## 重要なお知らせと免責事項

テキサス・インスツルメンツは、技術データと信頼性データ(データシートを含みます)、設計リソース(リファレンス デザインを含みます)、アプリケーションや設計に関する各種アドバイス、Web ツール、安全性情報、その他のリソースを、欠陥が存在する可能性のある「現状のまま」提供しており、商品性および特定目的に対する適合性の黙示保証、第三者の知的財産権の非侵害保証を含むいかなる保証も、明示的または黙示的にかかわらず拒否します。

これらのリソースは、テキサス・インスツルメンツ製品を使用する設計の経験を積んだ開発者への提供を意図したものです。(1) お客様のアプリケーションに適したテキサス・インスツルメンツ製品の選定、(2) お客様のアプリケーションの設計、検証、試験、(3) お客様のアプリケーションに該当する各種規格や、その他のあらゆる安全性、セキュリティ、規制、または他の要件への確実な適合に関する責任を、お客様のみが単独で負うものとします。

上記の各種リソースは、予告なく変更される可能性があります。これらのリソースは、リソースで説明されているテキサス・インスツルメンツ製品を使用するアプリケーションの開発の目的でのみ、テキサス・インスツルメンツはその使用をお客様に許諾します。これらのリソースに関して、他の目的で複製することや掲載することは禁止されています。テキサス・インスツルメンツや第三者の知的財産権のライセンスが付与されている訳ではありません。お客様は、これらのリソースを自身で使用した結果発生するあらゆる申し立て、損害、費用、損失、責任について、テキサス・インスツルメンツおよびその代理人を完全に補償するものとし、テキサス・インスツルメンツは一切の責任を拒否します。

テキサス・インスツルメンツの製品は、[テキサス・インスツルメンツの販売条件](#)、または [ti.com](https://www.ti.com) やかかるテキサス・インスツルメンツ製品の関連資料などのいずれかを通じて提供する適用可能な条項の下で提供されています。テキサス・インスツルメンツがこれらのリソースを提供することは、適用されるテキサス・インスツルメンツの保証または他の保証の放棄の拡大や変更を意味するものではありません。

お客様がいかなる追加条項または代替条項を提案した場合でも、テキサス・インスツルメンツはそれらに異議を唱え、拒否します。

郵送先住所：Texas Instruments, Post Office Box 655303, Dallas, Texas 75265  
Copyright © 2025, Texas Instruments Incorporated