

LM2901B-Q1、LM2901x-Q1 車載用、クワッド・コンパレータ

1 特長

- 車載アプリケーション向け認定済み
- 下記内容で AEC-Q100 認定済み:
 - デバイス温度グレード 1: 動作時周囲温度範囲: $-40^{\circ}\text{C} \sim 125^{\circ}\text{C}$
 - デバイス HBM ESD 分類レベル:
 - 「AV」バージョンは Class 1C
 - 他のすべてのバージョンは Class 2
 - デバイス CDM ESD 分類レベル C3
- 「B」デバイスの HBM ESD を 2kV に改善
- シングル電源またはデュアル電源
- 電源電圧に依存しない低い消費電流、コンパレータあたり 200 μA (代表値) (「B」バージョン)
- 低い入力バイアス電流、3.5nA (代表値) (「B」デバイス)
- 低い入力オフセット電流、0.5nA (代表値) (「B」デバイス)
- 低い入力オフセット電圧、 $\pm 0.37\text{mV}$ (代表値) (「B」デバイス)
- 同相入力電圧範囲にはグランドを含む
- 差動入力電圧範囲は最大定格電源電圧と同じ $\pm 36\text{V}$
- TTL、MOS、CMOS 互換出力
- SOT のシングル・バージョンについては、TL331-Q1 (SLVS969) を参照
- 複数パッケージのデュアル・バージョンについては、LM2903x-Q1 (SLCS141) を参照
- 機能安全対応
 - 機能安全準拠のシステム設計に役立つ資料を利用可能

2 アプリケーション

- 車載用
 - HEV/EV およびパワー・トレイン
 - インフォテインメントおよびクラスタ
 - 車体制御モジュール
- 産業用
- 電化製品

3 概要

LM2901B-Q1 デバイスは、業界標準の LM2901x-Q1 コンパレータ・ファミリの次世代バージョンです。この次世代ファミリは、小さいオフセット電圧、高い電源電圧への対応、小さい消費電流、小さい入力バイアス電流、短い伝搬遅延時間、優れた 2kV の ESD 性能などの特長と、ドロップイン互換で置換可能という利便性を兼ね備えており、コスト制約が厳しい用途で大きな価値を提供します。

すべてのデバイスは、広い電圧範囲にわたって動作するように設計された 4 つの独立した電圧コンパレータで構成されています。デュアル電源でも、2 つの電源間の差分が 2V \sim 36V の範囲内であり、VCC が入力同相電圧より 1.5V 以上高ければ、動作可能です。出力は、他のオープン・コレクタ出力に接続できます。

「V」バージョンは最大 32V で動作し、「B」バージョンは最大 36V で動作します。すべて、AEC-Q100 グレード 1 の温度範囲 $-40^{\circ}\text{C} \sim +125^{\circ}\text{C}$ で認定済みです。

製品情報

部品番号	パッケージ ⁽¹⁾	本体サイズ (公称)
LM2901B-Q1	TSSOP (14)	4.40mm × 5.00mm
LM2901-Q1	SOIC (14)	3.91mm × 8.65mm
LM2901A-Q1		
LM2901AV-Q1	SOT-23 (14)	4.20mm × 2.00mm
LM2901B-Q1 (プレビュー)	X2QFN (14)	2.00mm × 2.00mm
	WQFN (16)	3.00mm × 3.00mm

- (1) 利用可能なパッケージについては、データシートの末尾にある注文情報を参照してください。

ファミリ比較表

仕様	LM2901B-Q1	LM2901-Q1	LM2901V-Q1	LM2901AV-Q1	単位
電源電圧	2 \sim 36	2 \sim 30	2 \sim 32	2 \sim 32	V
総消費電流 (5V \sim 最大値 36V)	0.6 \sim 0.8	1 \sim 2.5	1 \sim 2.5	1 \sim 2.5	mA
温度範囲	-40 \sim 125	-40 \sim 125	-40 \sim 125	-40 \sim 125	$^{\circ}\text{C}$
ESD (HBM)	2000	2000	2000	1000	V
オフセット電圧 (最大過熱値)	± 5.5	± 15	± 15	± 4	mV
入力バイアス電流 (代表値 / 最大値)	3.5 / 25	25 / 250	25 / 250	25 / 250	nA



ファミリ比較表 (continued)

仕様	LM2901B-Q1	LM2901-Q1	LM2901V-Q1	LM2901AV-Q1	単位
応答時間 (代表値)	1	1.3	1.3	1.3	μsec

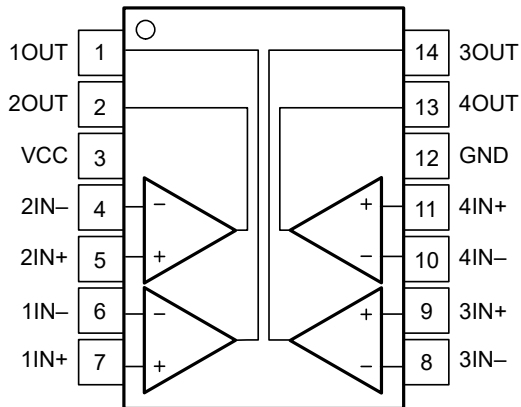
Table of Contents

1 特長	1	6.14 Typical Characteristics: LM2901x-Q1.....	17
2 アプリケーション	1	7 Detailed Description	18
3 概要	1	7.1 Overview.....	18
4 Revision History	3	7.2 Functional Block Diagram.....	18
5 Pin Configuration and Functions	4	7.3 Feature Description.....	18
6 Specifications	6	7.4 Device Functional Modes.....	18
6.1 Absolute Maximum Ratings for LM2901B-Q1.....	6	8 Application and Implementation	19
6.2 Absolute Maximum Ratings for LM2901x-Q1.....	6	8.1 Application Information.....	19
6.3 ESD Ratings for LM2901B-Q1.....	7	8.2 Typical Application.....	19
6.4 ESD Ratings for LM2901x-Q1.....	7	9 Power Supply Recommendations	21
6.5 Recommended Operating Conditions for LM2901B-Q1.....	7	10 Layout	21
6.6 Recommended Operating Conditions for LM2901x-Q1.....	7	10.1 Layout Guidelines.....	21
6.7 Thermal Information for LM2901B-Q1.....	8	10.2 Layout Example.....	21
6.8 Thermal Information for LM2901x-Q1.....	8	11 Device and Documentation Support	22
6.9 Electrical Characteristics for LM2901B-Q1.....	9	11.1 Documentation Support.....	22
6.10 Switching Characteristics for LM2901B-Q1.....	9	11.2 Related Links.....	22
6.11 Electrical Characteristics for LM2901x-Q1.....	10	11.3 Trademarks.....	22
6.12 Switching Characteristics for LM2901x-Q1.....	10	11.4 静電気放電に関する注意事項.....	22
6.13 Typical Characteristics: LM2901B-Q1.....	11	11.5 用語集.....	22
		12 Mechanical, Packaging, and Orderable Information	22

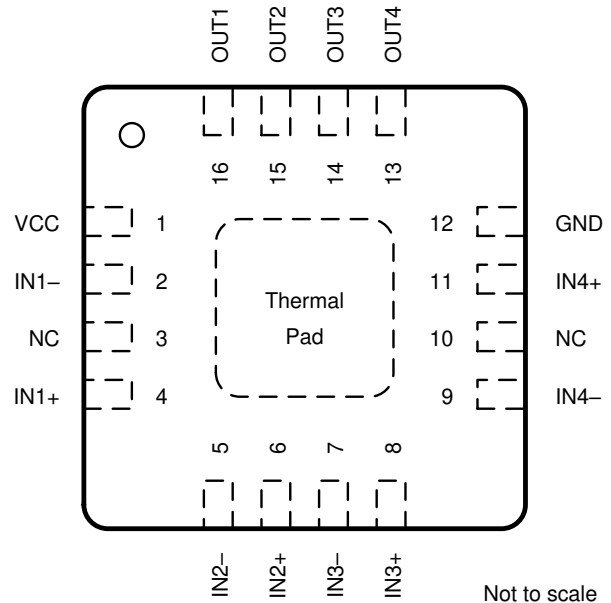
4 Revision History

Changes from Revision F (May 2021) to Revision G (March 2023)	Page
• 最初のページの「特長」と「概要」のテキストを「B」バージョンに更新.....	1
• 最初のページの CDM ESD 分類を更新.....	1
• 最初のページに「ファミリ比較」表を追加.....	1
• Added "B" device description, electrical tables, graphs and pinouts throughout.....	6
Changes from Revision E (January 2015) to Revision F (May 2021)	Page
• 最初のページの HBM ESD 分類を更新.....	1
• 文書全体にわたって表、図、相互参照の採番方法を更新.....	1
• Added separate line for 1kV LM2901AV-Q1 HBM in ESD Ratings table.....	7
• Changed incorrect text in Apps Section Feature Description.....	18
• Changed incorrect Layout Example pinout.....	21
Changes from Revision D (April 2008) to Revision E (January 2015)	Page
• 「特長」セクションに AEC-Q100 認定内容を追加.....	1
• 「ESD 定格」表、「機能説明」セクション、「デバイスの機能モード」セクション、「アプリケーションと実装」セクション、「電源に関する推奨事項」セクション、「レイアウト」セクション、「デバイスおよびドキュメントのサポート」セクション、「メカニカル、パッケージ、および注文情報」セクションを追加.....	1
• Added the common-mode voltage note to the V_{ICR} parameter in the <i>Electrical Characteristics</i> table.....	10

5 Pin Configuration and Functions

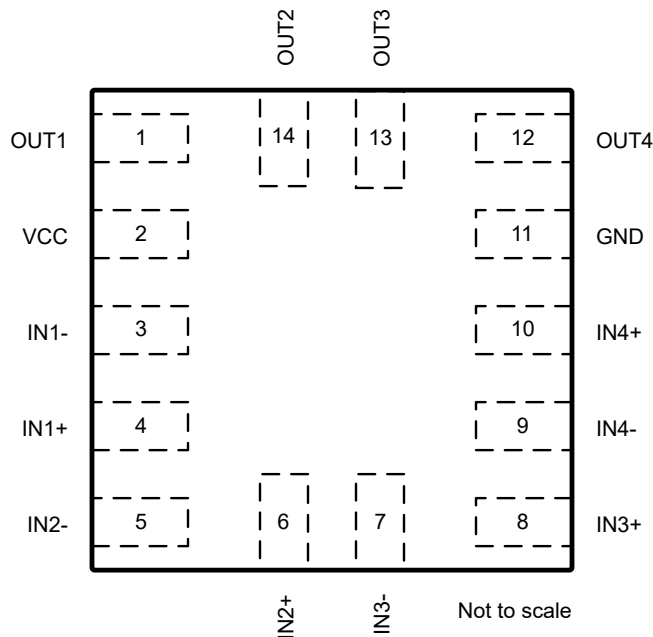


**FIG 5-1. D, PW and DYY Packages
 14-Pin SOIC, TSSOP and SOT-23
 Top View**



NOTE: Connect exposed thermal pad directly to GND pin.

**FIG 5-2. RTE Package
 16-Pad WQFN With Exposed Thermal Pad
 Top View**



**FIG 5-3. RUC Package
 14-Pad X2QFN
 Top View**

表 5-1. Pin Functions

NAME ⁽¹⁾	PIN			I/O	DESCRIPTION
	SOIC, TSSOP, DYY	X2QFN	WQFN		
OUT1 ⁽¹⁾	1	14	16	Output	Output pin of the comparator 2
OUT2 ⁽¹⁾	2	1	15	Output	Output pin of the comparator 1
V _{CC}	3	2	1	—	Positive supply
IN2 [−] ⁽¹⁾	4	3	5	Input	Negative input pin of the comparator 1
IN2 ⁺ ⁽¹⁾	5	4	6	Input	Positive input pin of the comparator 1
IN1 [−] ⁽¹⁾	6	5	2	Input	Negative input pin of the comparator 2
IN1 ⁺ ⁽¹⁾	7	6	4	Input	Positive input pin of the comparator 2
IN3 [−]	8	7	7	Input	Negative input pin of the comparator 3
IN3 ⁺	9	8	8	Input	Positive input pin of the comparator 3
IN4 [−]	10	9	9	Input	Negative input pin of the comparator 4
IN4 ⁺	11	10	11	Input	Positive input pin of the comparator 4
GND	12	11	12	—	Negative supply
OUT4	13	12	13	Output	Output pin of the comparator 4
OUT3	14	13	14	Output	Output pin of the comparator 3
NC	—	—	3	—	No Internal Connection - Leave floating or GND
NC	—	—	10	—	No Internal Connection - Leave floating or GND
Thermal Pad	—	—	PAD	—	Connect directly to GND pin

(1) Some manufacturers transpose the names of channels 1 & 2. Electrically the pinouts are identical, just a difference in channel naming convention.

6 Specifications

6.1 Absolute Maximum Ratings for LM2901B-Q1

over operating free-air temperature range (unless otherwise noted)⁽¹⁾

	MIN	MAX	UNIT
Supply voltage: $V_S = (V+) - (V-)$	-0.3	38	V
Differential input voltage: V_{ID} ⁽²⁾		±38	V
Input pins (IN+, IN-)	-0.3	38	V
Current into input pins (IN+, IN-)		-50	mA
Output pin (OUT)	-0.3	38	V
Output sink current		25	mA
Output short-circuit duration ⁽³⁾		Unlimited	s
Junction temperature, T_J	TBD	150	°C
Storage temperature, T_{stg}	-65	150	°C

- (1) Stresses beyond those listed under *Absolute Maximum Ratings* may cause permanent damage to the device. These are stress ratings only, which do not imply functional operation of the device at these or any other conditions beyond those indicated under *Recommended Operating Conditions*. Exposure to absolute-maximum-rated conditions for extended periods may affect device reliability.
- (2) Differential voltages are at IN+ with respect to IN-
- (3) Short circuits from outputs to V+ can cause excessive heating and eventual destruction.

6.2 Absolute Maximum Ratings for LM2901x-Q1

over operating free-air temperature range (unless otherwise noted)⁽¹⁾

	MIN	MAX	UNIT
Supply voltage, V_{CC} ⁽²⁾		36	V
Differential input voltage, V_{ID} ⁽³⁾		±36	
Input voltage range, V_I (either input)	-0.3	36	
Output voltage, V_O		36	mA
Output current, I_O		20	
Duration of output short circuit to ground ⁽⁴⁾		Unlimited	
Operating virtual junction temperature, T_J		150	°C
Storage temperature, T_{stg}	-65	150	°C

- (1) Operation outside the Absolute Maximum Ratings may cause permanent device damage. Absolute Maximum Ratings do not imply functional operation of the device at these or any other conditions beyond those listed under Recommended Operating Conditions. If used outside the Recommended Operating Conditions but within the Absolute Maximum Ratings, the device may not be fully functional, and this may affect device reliability, functionality, performance, and shorten the device lifetime.
- (2) All voltage values, except differential voltages, are with respect to network ground.
- (3) Differential voltages are at IN+ with respect to IN-.
- (4) Short circuits from outputs to V_{CC} can cause excessive heating and eventual destruction.

6.3 ESD Ratings for LM2901B-Q1

			VALUE	UNIT
V _(ESD)	Electrostatic discharge	Human-body model (HBM), per AEC Q100-002 ⁽¹⁾	±2000	V
		Charged-device model (CDM), per AEC Q100-011 ⁽¹⁾	±1000	

(1) AEC Q100-002 indicates that HBM stressing shall be in accordance with the ANSI/ESDA/JEDEC JS-001 specification.

6.4 ESD Ratings for LM2901x-Q1

			MIN	MAX	UNIT
V _(ESD)	Electrostatic discharge	Human-body model (HBM), per AEC Q100-002 ⁽¹⁾ , (LM2901-Q1, LM2901V-Q1)	-2000	2000	V
		Human-body model (HBM), per AEC Q100-002 ⁽¹⁾ , (LM2901AV-Q1 Only)	-1000	1000	
		Charged-device model (CDM), per AEC Q100-011	-1000	1000	

(1) AEC Q100-002 indicates that HBM stressing shall be in accordance with the ANSI/ESDA/JEDEC JS-001 specification.

6.5 Recommended Operating Conditions for LM2901B-Q1

over operating free-air temperature range (unless otherwise noted)

	MIN	MAX	UNIT
Supply voltage: $V_S = (V+) - (V-)$	2	36	V
Ambient temperature, T_A , LM2901B-Q1	-40	125	°C
Input Voltage Range, V_{IVR}	(V-) – 0.1	(V+) – 2.0	V

6.6 Recommended Operating Conditions for LM2901x-Q1

over operating free-air temperature range (unless otherwise noted)

		MIN	MAX	UNIT	
V _{CC}	Supply voltage	LM2901-Q1	2	30	V
		LM2901V-Q1, LM2901AV-Q1	2	32	
T _A	Ambient temperature	-40	125	°C	
I _O	Output current (per comparator)	0	4	mA	

6.7 Thermal Information for LM2901B-Q1

THERMAL METRIC ⁽¹⁾		LM2901B-Q1					UNIT
		D (SOIC)	PW (TSSOP)	DDY (SOT-23)	RTE (QFN)	RUC (X2QFN)	
		14 PINS	14 PINS	14 PINS	16 PINS	14 PINS	
R _{θJA}	Junction-to-ambient thermal resistance	111.2	136.6				°C/W
R _{θJC(top)}	Junction-to-case (top) thermal resistance	66.9	66.6				
R _{θJB}	Junction-to-board thermal resistance	67.8	79.8				
ψ _{JT}	Junction-to-top characterization parameter	28.0	17.8				
ψ _{JB}	Junction-to-board characterization parameter	67.4	79.3				
R _{θJC(bot)}	Junction-to-case (bottom) thermal resistance	-	-	-		-	

- (1) For more information about traditional and new thermal metrics, see the Semiconductor and IC Package Thermal Metrics report, [SPRA953](#).

6.8 Thermal Information for LM2901x-Q1

THERMAL METRIC ⁽¹⁾		LM2901x-Q1		UNIT
		D (SOIC)	PW (TSSOP)	
		14 PINS	14 PINS	
R _{θJA}	Junction-to-ambient thermal resistance ⁽²⁾	88.6	119.1	°C/W
R _{θJC(top)}	Junction-to-case (top) thermal resistance	49.1	47.9	°C/W
R _{θJB}	Junction-to-board thermal resistance	43.0	60.9	°C/W
ψ _{JT}	Junction-to-top characterization parameter	13.6	5.4	°C/W
ψ _{JB}	Junction-to-board characterization parameter	42.7	60.3	°C/W

- (1) For more information about traditional and new thermal metrics, see the *Semiconductor and IC Package Thermal Metrics* application report, [SPRA953](#).
- (2) Maximum power dissipation is a function of T_{J(max)}, R_{θJA}, and T_A. The maximum allowable power dissipation at any allowable ambient temperature is P_D = (T_{J(max)} - T_A) / R_{θJA}. Operating at the absolute maximum T_J of 150°C can affect reliability.

6.9 Electrical Characteristics for LM2901B-Q1

$V_S = 5\text{ V}$, $V_{CM} = (V-)$; $T_A = 25^\circ\text{C}$ (unless otherwise noted).

PARAMETER		TEST CONDITIONS	MIN	TYP	MAX	UNIT
V_{IO}	Input offset voltage	$V_S = 5\text{ to }36\text{V}$	-3.5	± 0.37	3.5	mV
		$V_S = 5\text{ to }36\text{V}$, $T_A = -40^\circ\text{C to }+125^\circ\text{C}$	-5.5		5.5	
I_B	Input bias current			-3.5	-25	nA
		$T_A = -40^\circ\text{C to }+125^\circ\text{C}$			-50	nA
I_{OS}	Input offset current		-25	± 0.5	25	nA
		$T_A = -40^\circ\text{C to }+125^\circ\text{C}$	-50		50	nA
V_{CM}	Common mode range ⁽¹⁾	$V_S = 3\text{ to }36\text{V}$	(V-)		(V+) - 1.5	V
		$V_S = 3\text{ to }36\text{V}$, $T_A = -40^\circ\text{C to }+125^\circ\text{C}$	(V-)		(V+) - 2.0	V
A_{VD}	Large signal differential voltage amplification ⁽²⁾	$V_S = 15\text{V}$, $V_O = 1.4\text{V to }11.4\text{V}$; $R_L \geq 15\text{k to }(\text{V+})$	50	200		V/mV
V_{OL}	Low level output Voltage {swing from (V-)}	$I_{SINK} \leq 4\text{mA}$, $V_{ID} = -1\text{V}$		110	400	mV
		$I_{SINK} \leq 4\text{mA}$, $V_{ID} = -1\text{V}$ $T_A = -40^\circ\text{C to }+125^\circ\text{C}$			550	mV
I_{OH-LKG}	High-level output leakage current	(V+) = $V_O = 5\text{ V}$; $V_{ID} = 1\text{V}$		0.1	50	nA
		(V+) = $V_O = 36\text{V}$; $V_{ID} = 1\text{V}$			100	nA
I_{OL}	Low level output current	$V_{OL} = 1.5\text{V}$; $V_{ID} = -1\text{V}$; $V_S = 5\text{V}$	6	21		mA
I_Q	Quiescent current (all comparators)	$V_S = 5\text{ V}$, no load		0.8	1.2	mA
		$V_S = 36\text{ V}$, no load, $T_A = -40^\circ\text{C to }+125^\circ\text{C}$		1	1.6	mA

- (1) The voltage at either input should not be allowed to go negative by more than 0.3 V otherwise output may be incorrect and excessive input current can flow. The upper end of the common-mode voltage range is limited by $V_{CC} - 2\text{V}$. However only one input needs to be in the valid common mode range, the other input can go up the maximum V_{CC} level and the comparator provides a proper output state. Either or both inputs can go to maximum V_{CC} level without damage.
- (2) This parameter is ensured by design and/or characterization and is not tested in production.

6.10 Switching Characteristics for LM2901B-Q1

$V_S = 5\text{V}$, $V_{O_PULLUP} = 5\text{V}$, $V_{CM} = V_S/2$, $C_L = 15\text{pF}$, $R_L = 5.1\text{k Ohm}$, $T_A = 25^\circ\text{C}$ (unless otherwise noted).

PARAMETER		TEST CONDITIONS	MIN	TYP	MAX	UNIT
t_{response}	Propagation delay time, high-to-low; Small scale input signal ⁽¹⁾	Input overdrive = 5mV, Input step = 100mV		1000		ns
t_{response}	Propagation delay time, high-to-low; TTL input signal ⁽¹⁾	TTL input with $V_{\text{ref}} = 1.4\text{V}$		300		ns

- (1) High-to-low and low-to-high refers to the transition at the input.

6.11 Electrical Characteristics for LM2901x-Q1

$V_{CC} = 5\text{ V}$, at specified free-air temperature (unless otherwise noted)

PARAMETER	TEST CONDITIONS ⁽¹⁾		T_A ⁽²⁾	MIN	TYP	MAX	UNIT
V_{IO} Input offset voltage	$V_{IC} = V_{ICR(\min)}$, $V_O = 1.4\text{ V}$, $V_{CC} = 5\text{ V}$ to MAX ⁽³⁾	Non A devices	25°C		2	7	mV
			Full range			15	
		A suffix devices	25°C		1	2	
			Full range			4	
I_{IO} Input offset current	$V_O = 1.4\text{ V}$		25°C		5	50	nA
			Full range			200	
I_{IB} Input bias current	$V_O = 1.4\text{ V}$		25°C		-25	-250	nA
			Full range			-500	
V_{ICR} Common-mode input-voltage range ⁽⁴⁾			25°C	0	$V_{CC} - 1.5$		V
			Full range	0	$V_{CC} - 2$		
A_{VD} Large-signal differential-voltage amplification	$V_{CC} = 15\text{ V}$, $V_O = 1.4\text{ V}$ to 11.4 V, $R_L \geq 15\text{ k}\Omega$ to V_{CC}		25°C	25	100		V/mV
I_{OH} High-level output current	$V_{ID} = 1\text{ V}$	$V_{OH} = 5\text{ V}$	25°C		0.1	50	nA
		$V_{OH} = V_{CC}\text{ MAX}^{(3)}$	Full range			1	μA
V_{OL} Low-level output voltage	$V_{ID} = -1\text{ V}$	$I_{OL} = 4\text{ mA}$	25°C		150	400	mV
			Full range			700	
I_{OL} Low-level output current	$V_{ID} = -1\text{ V}$	$V_{OL} = 1.5\text{ V}$	25°C	6	16		mA
I_{CC} Supply current (four comparators)	$V_O = 2.5\text{ V}$, No load	$V_{CC} = 5\text{ V}$	25°C		0.8	2	
		$V_{CC} = \text{MAX}^{(3)}$			1	2.5	

- (1) All characteristics are measured with zero common-mode input voltage, unless otherwise specified.
- (2) Full range (MIN to MAX) is -40°C to 125°C . All characteristics are measured with zero common-mode input voltage, unless otherwise specified.
- (3) $V_{CC}\text{ MAX} = 30\text{ V}$ for non-V devices and 32 V for V-suffix devices.
- (4) The voltage at either the input or common mode should not be allowed to negative by more than 0.3 V . The upper end of the common-mode voltage range is $V_{CC+} - 1.5\text{ V}$; however, one input can exceed V_{CC} , and the comparator will provide a proper output state as long as the other input remains in the common-mode range. Either or both inputs can go to 30 V without damage.

6.12 Switching Characteristics for LM2901x-Q1

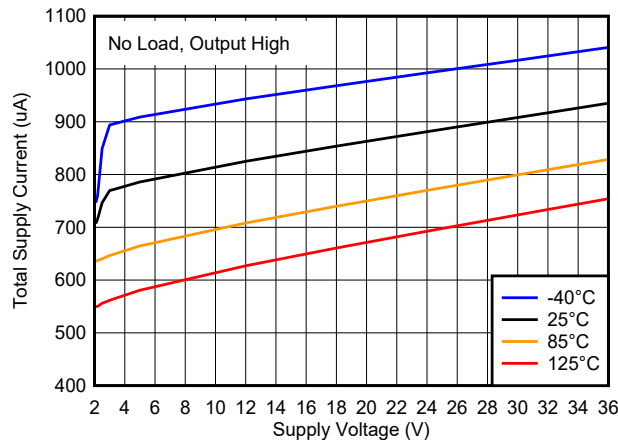
$V_{CC} = 5\text{ V}$, $T_A = 25^\circ\text{C}$

PARAMETER	TEST CONDITIONS	MIN	TYP	MAX	UNIT
Response time ⁽²⁾	R_L connected to 5 V through $5.1\text{ k}\Omega$, $C_L = 15\text{ pF}^{(1)}$	100-mV input step with 5-mV overdrive		1.3	μs
		TTL-level input step		0.3	

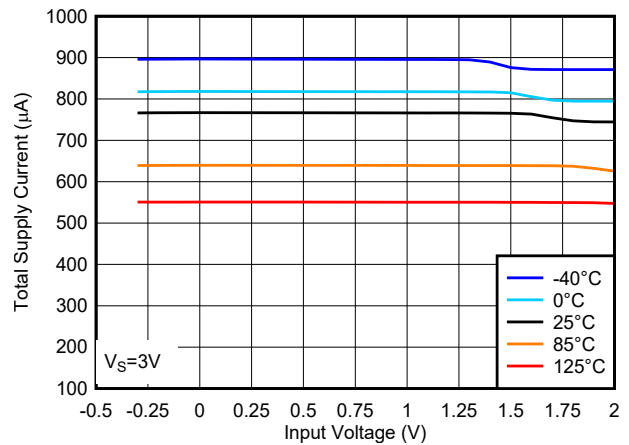
- (1) C_L includes probe and jig capacitance.
- (2) The response time specified is the interval between the input step function and the instant when the output crosses 1.4 V .

6.13 Typical Characteristics: LM2901B-Q1

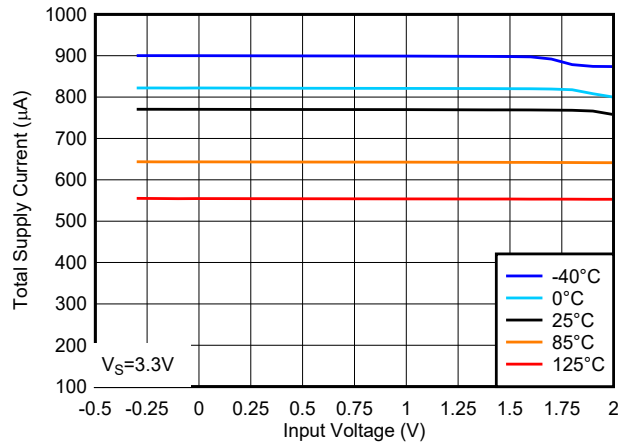
$T_A = 25^\circ\text{C}$, $V_S = 5\text{ V}$, $R_{\text{PULLUP}} = 5.1\text{k}$, $C_L = 15\text{ pF}$, $V_{\text{CM}} = 0\text{ V}$, $V_{\text{UNDERDRIVE}} = 100\text{ mV}$, $V_{\text{OVERDRIVE}} = 100\text{ mV}$ unless otherwise noted.



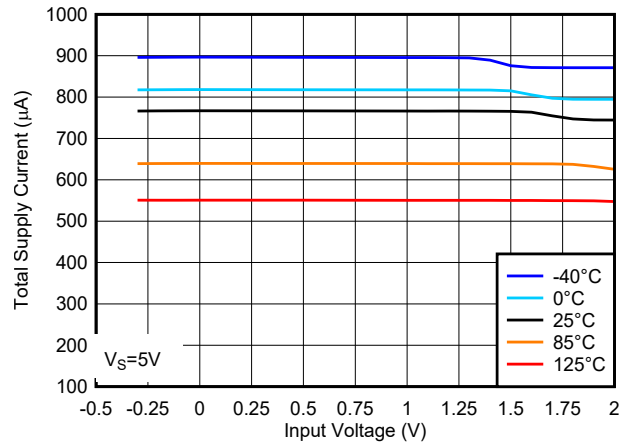
6-1. Total Supply Current vs. Supply Voltage



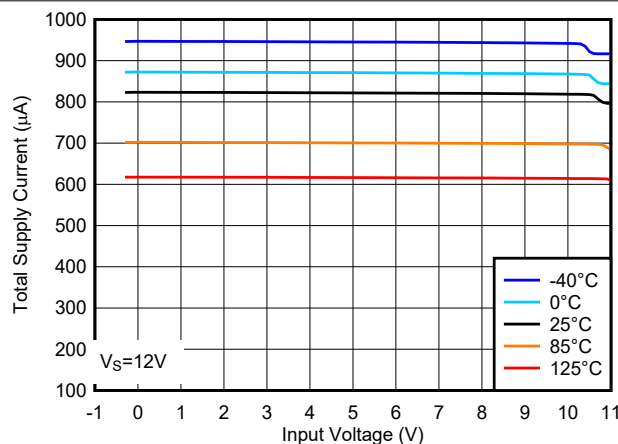
6-2. Total Supply Current vs. Input Voltage at 3V



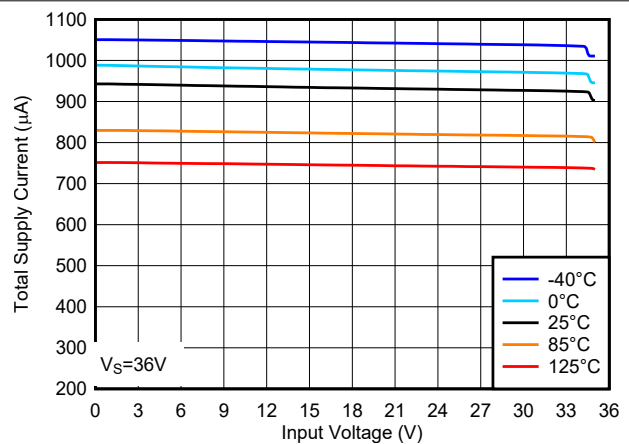
6-3. Total Supply Current vs. Input Voltage at 3.3V



6-4. Total Supply Current vs. Input Voltage at 5V



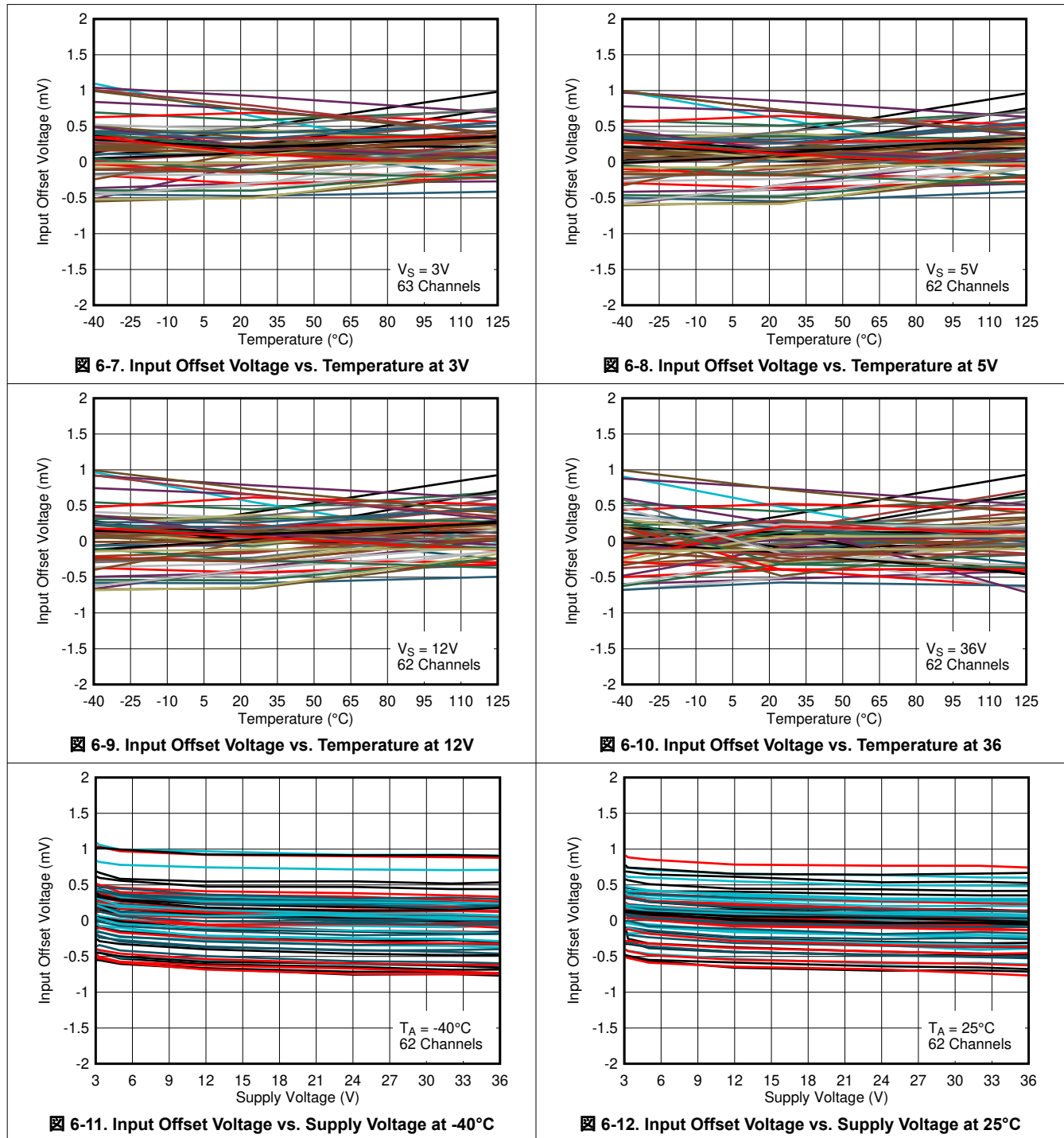
6-5. Total Supply Current vs. Input Voltage at 12V



6-6. Total Supply Current vs. Input Voltage at 36V

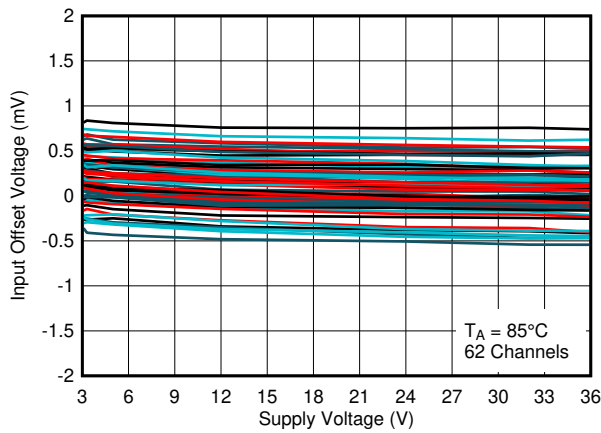
6.13 Typical Characteristics: LM2901B-Q1 (continued)

$T_A = 25^\circ\text{C}$, $V_S = 5\text{ V}$, $R_{\text{PULLUP}} = 5.1\text{ k}$, $C_L = 15\text{ pF}$, $V_{\text{CM}} = 0\text{ V}$, $V_{\text{UNDERDRIVE}} = 100\text{ mV}$, $V_{\text{OVERDRIVE}} = 100\text{ mV}$ unless otherwise noted.

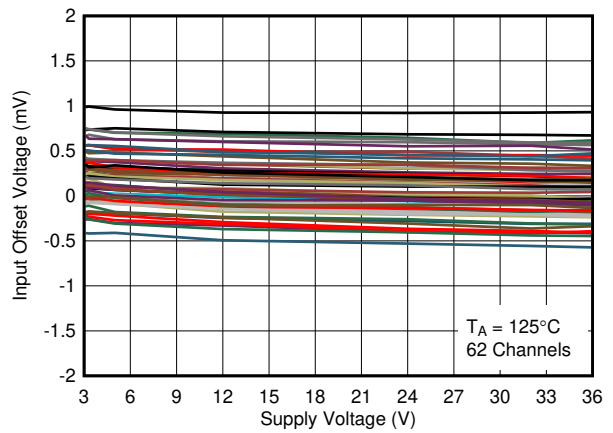


6.13 Typical Characteristics: LM2901B-Q1 (continued)

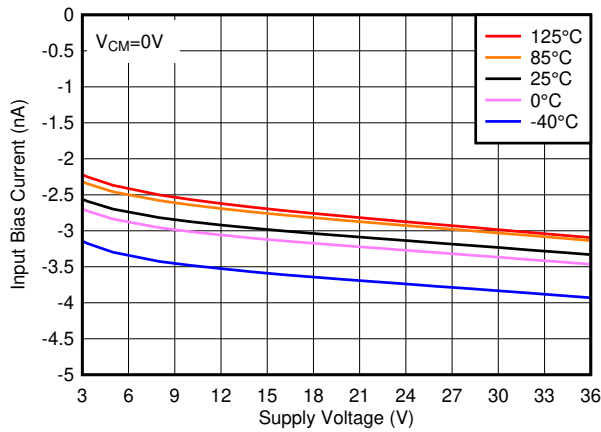
$T_A = 25^\circ\text{C}$, $V_S = 5\text{ V}$, $R_{\text{PULLUP}} = 5.1\text{ k}$, $C_L = 15\text{ pF}$, $V_{\text{CM}} = 0\text{ V}$, $V_{\text{UNDERDRIVE}} = 100\text{ mV}$, $V_{\text{OVERDRIVE}} = 100\text{ mV}$ unless otherwise noted.



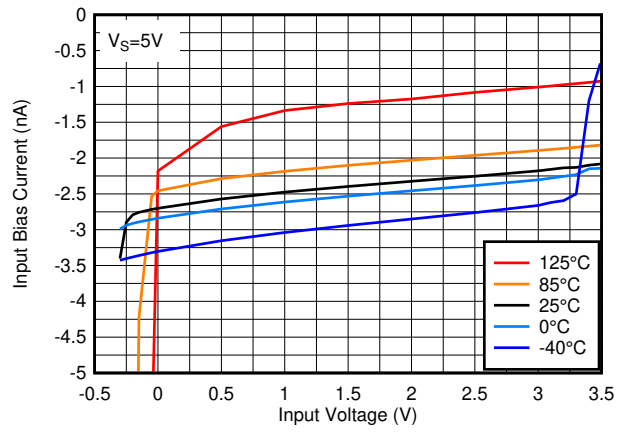
6-13. Input Offset Voltage vs. Supply Voltage at 85°C



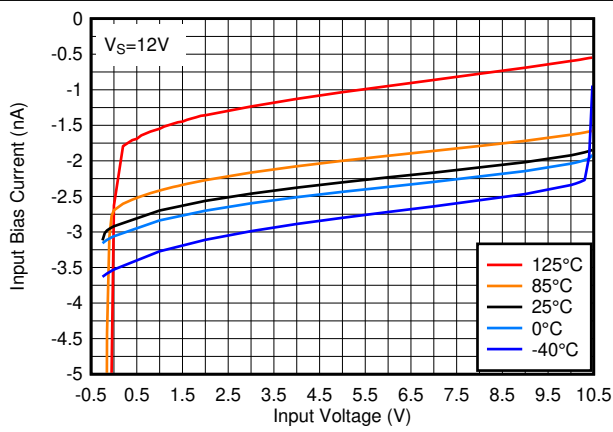
6-14. Input Offset Voltage vs. Supply Voltage at 125°C



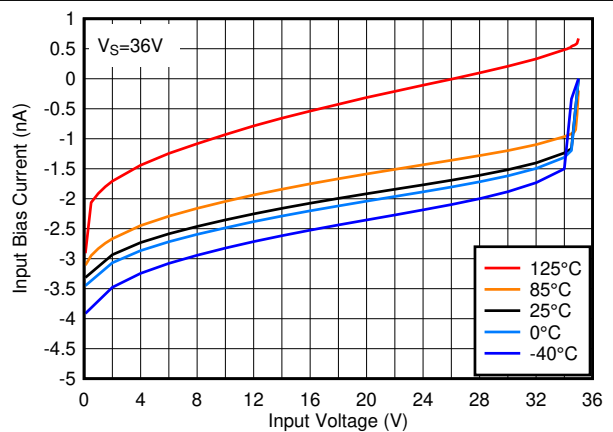
6-15. Input Bias Current vs. Supply Voltage



6-16. Input Bias Current vs. Input Voltage at 5V



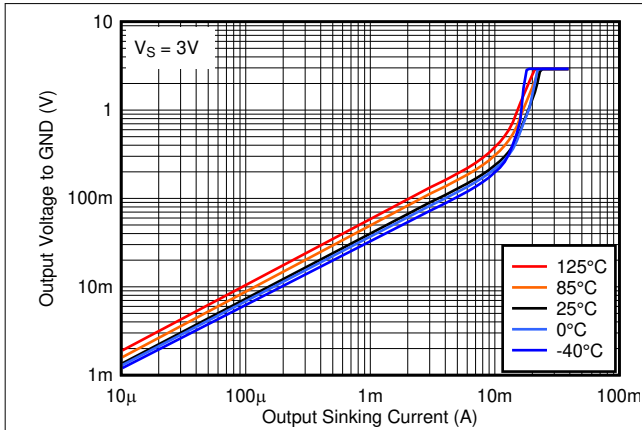
6-17. Input Bias Current vs. Input Voltage at 12V



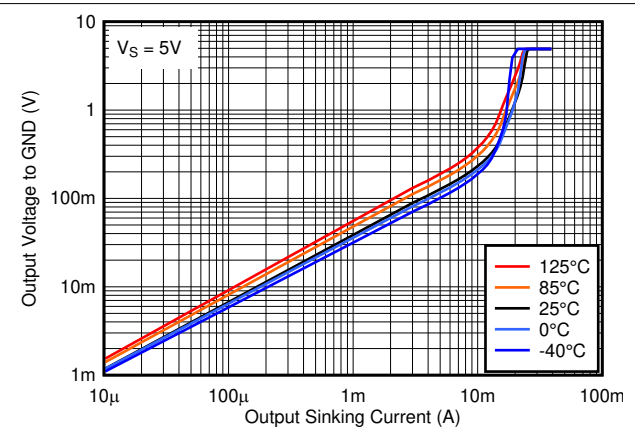
6-18. Input Bias Current vs. Input Voltage at 36V

6.13 Typical Characteristics: LM2901B-Q1 (continued)

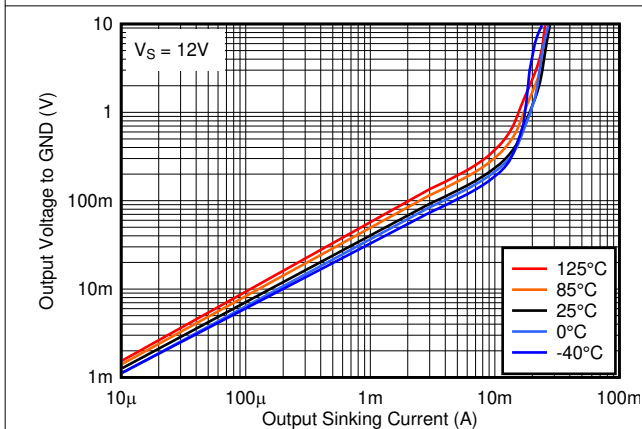
$T_A = 25^\circ\text{C}$, $V_S = 5\text{ V}$, $R_{\text{PULLUP}} = 5.1\text{k}$, $C_L = 15\text{ pF}$, $V_{\text{CM}} = 0\text{ V}$, $V_{\text{UNDERDRIVE}} = 100\text{ mV}$, $V_{\text{OVERDRIVE}} = 100\text{ mV}$ unless otherwise noted.



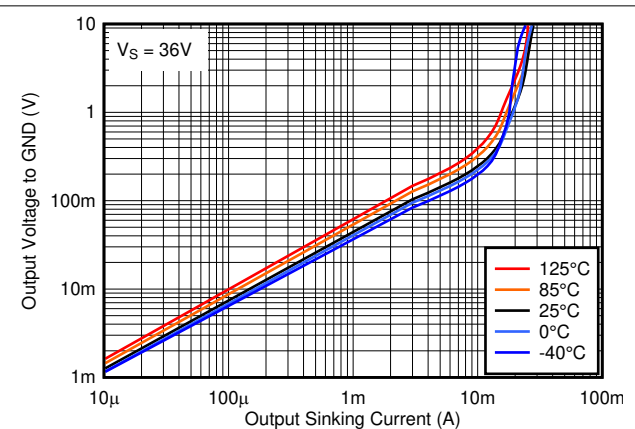
6-19. Output Low Voltage vs. Output Sinking Current at 3V



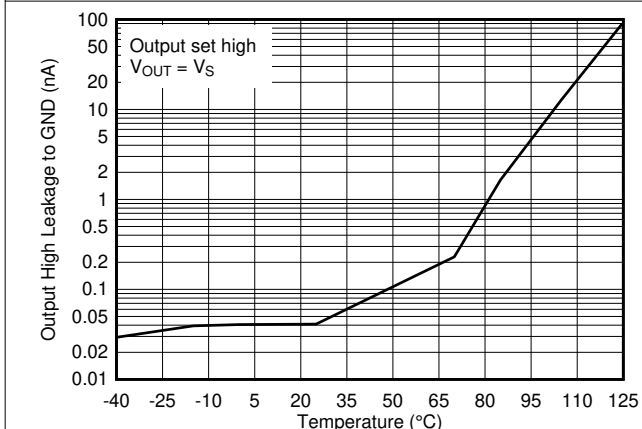
6-20. Output Low Voltage vs. Output Sinking Current at 5V



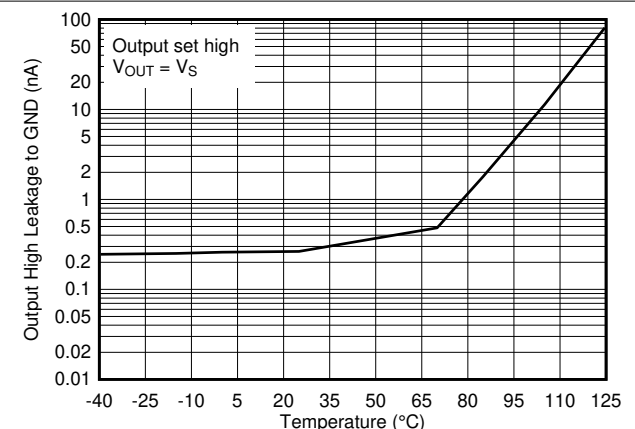
6-21. Output Low Voltage vs. Output Sinking Current at 12V



6-22. Output Low Voltage vs. Output Sinking Current at 36V



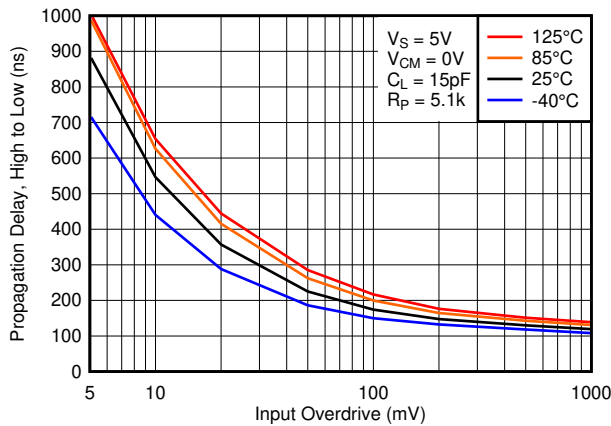
6-23. Output High Leakage Current vs. Temperature at 5V



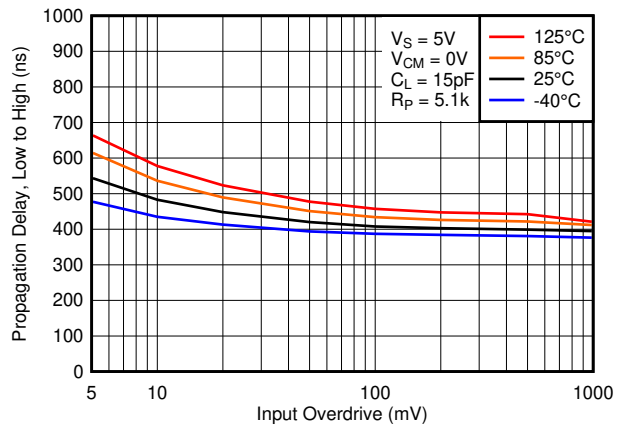
6-24. Output High Leakage Current vs. Temperature at 36V

6.13 Typical Characteristics: LM2901B-Q1 (continued)

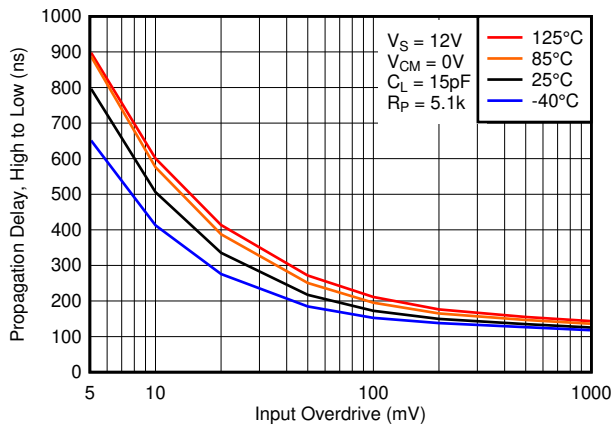
$T_A = 25^\circ\text{C}$, $V_S = 5\text{ V}$, $R_{\text{PULLUP}} = 5.1\text{ k}$, $C_L = 15\text{ pF}$, $V_{\text{CM}} = 0\text{ V}$, $V_{\text{UNDERDRIVE}} = 100\text{ mV}$, $V_{\text{OVERDRIVE}} = 100\text{ mV}$ unless otherwise noted.



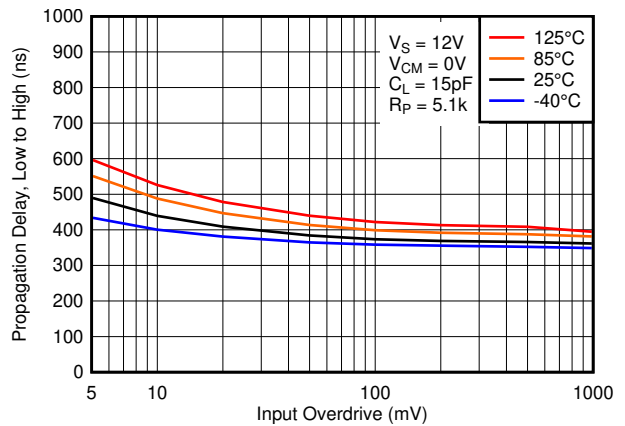
6-25. High to Low Propagation Delay vs. Input Overdrive Voltage, 5V



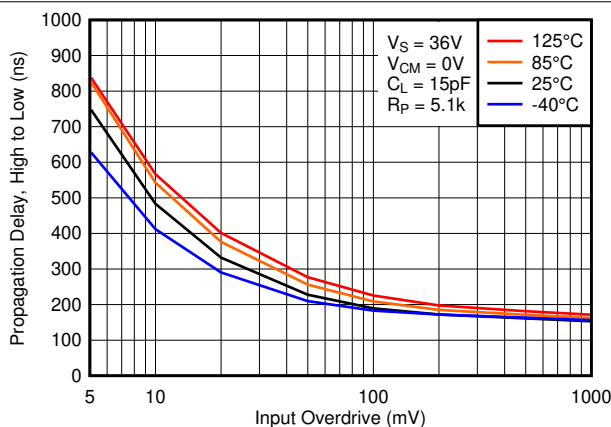
6-26. Low to High Propagation Delay vs. Input Overdrive Voltage, 5V



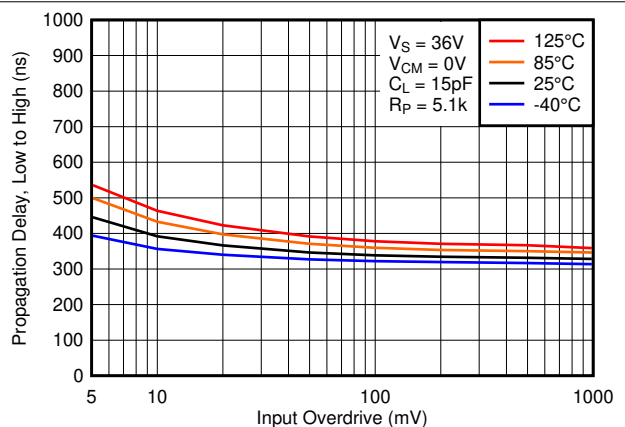
6-27. High to Low Propagation Delay vs. Input Overdrive Voltage, 12V



6-28. Low to High Propagation Delay vs. Input Overdrive Voltage, 12V



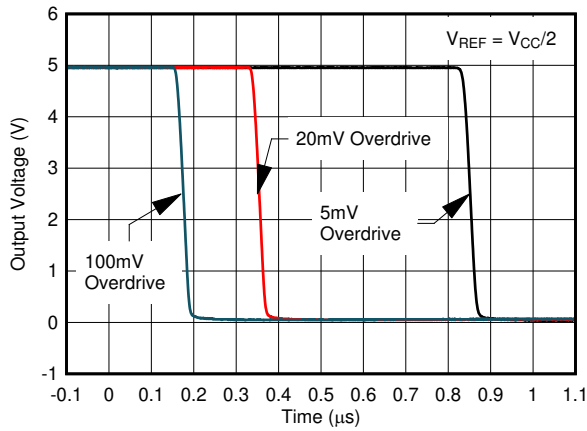
6-29. High to Low Propagation Delay vs. Input Overdrive Voltage, 36V



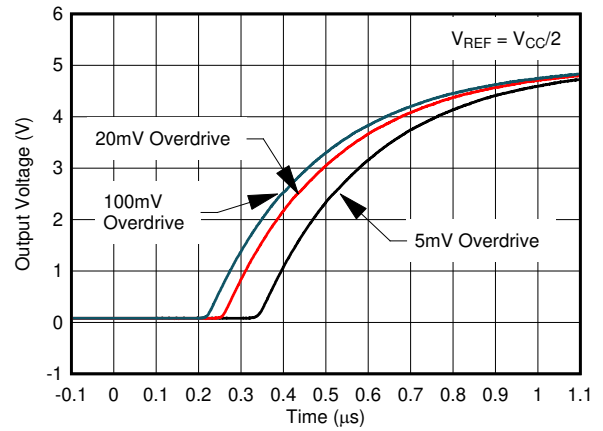
6-30. Low to High Propagation Delay vs. Input Overdrive Voltage, 36V

6.13 Typical Characteristics: LM2901B-Q1 (continued)

$T_A = 25^\circ\text{C}$, $V_S = 5\text{ V}$, $R_{\text{PULLUP}} = 5.1\text{ k}$, $C_L = 15\text{ pF}$, $V_{\text{CM}} = 0\text{ V}$, $V_{\text{UNDERDRIVE}} = 100\text{ mV}$, $V_{\text{OVERDRIVE}} = 100\text{ mV}$ unless otherwise noted.

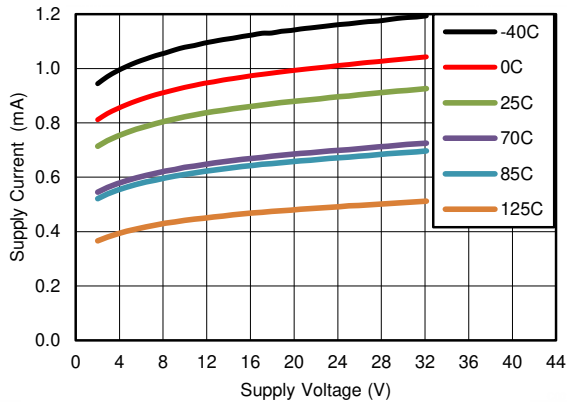


6-31. Response Time for Various Overdrives, High-to-Low Transition

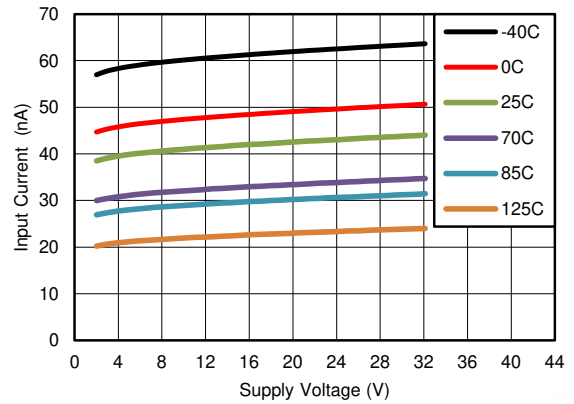


6-32. Response Time for Various Overdrives, Low-to-High Transition

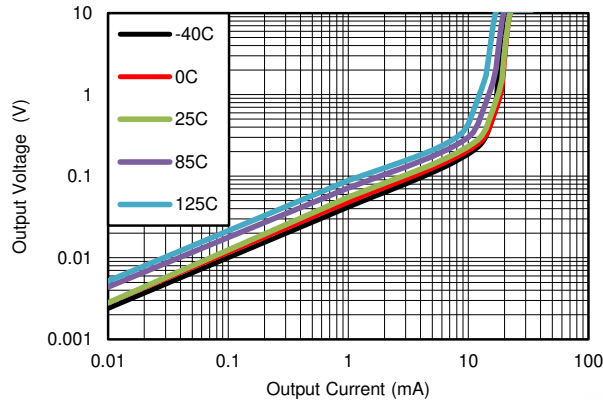
6.14 Typical Characteristics: LM2901x-Q1



6-33. Supply Current vs Supply Voltage



6-34. Input Bias Current vs Supply Voltage



6-35. Output Saturation Voltage

7 Detailed Description

7.1 Overview

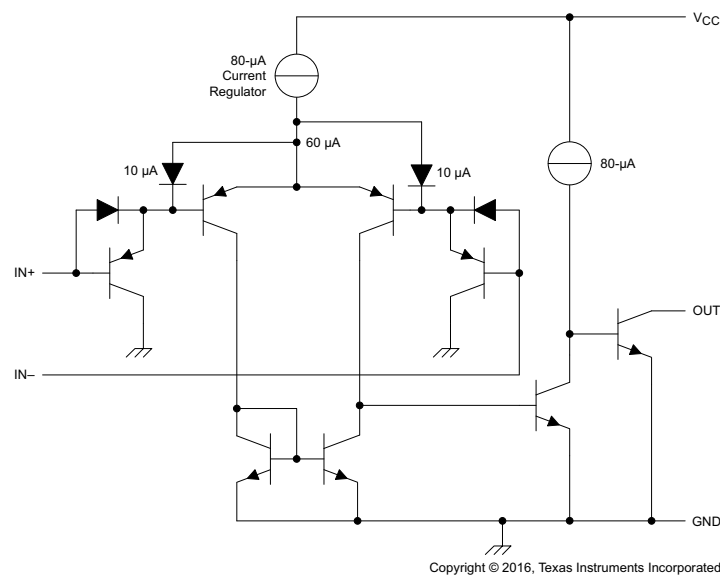
The LM2901-Q1 family is a quad comparator with the ability to operate up to 36 V on the supply pin. This standard device has proven ubiquity and versatility across a wide range of applications. This is due to its very wide supply voltages range (2 V to 36 V), low I_q and fast response.

This device is AEC-Q100 qualified and can operate over a wide temperature range of -40°C to 125°C .

The open-drain output allows the user to configure the output's logic low voltage (V_{OL}) and can be utilized to enable the comparator to be used in AND functionality.

The "B" versions add dedicated ESD protections on all the pins for improved ESD performance as well as improved negative input voltage handling. Please see Application Note [SNOAA35](#) for more information

7.2 Functional Block Diagram



7.3 Feature Description

LM2901-Q1 family consists of a PNP Darlington pair input, allowing the device to operate with very high gain and fast response with minimal input bias current. The input Darlington pair creates a limit on the input common mode voltage capability, allowing LM2901-Q1 to accurately function from ground to $V_{CC}-1.5\text{V}$ differential input. This enables much head room for modern day supplies of 3.3 V and 5.0 V.

The output consists of an open drain NPN (pull-down or low side) transistor. The output NPN will sink current when the negative input voltage is higher than the positive input voltage and the offset voltage. The V_{OL} is resistive and will scale with the output current. Please see [§ 6-19](#), [§ 6-20](#) and [§ 6-21](#) for V_{OL} values with respect to the output current.

The special pinout of this device separates input pins from the output pins to reduce parasitic coupling between input and output.

7.4 Device Functional Modes

7.4.1 Voltage Comparison

The LM2901-Q1 family of devices operates solely as a voltage comparator, comparing the differential voltage between the positive and negative pins and outputs a logic low or high impedance (logic high with pullup) based on the input differential polarity.

8 Application and Implementation

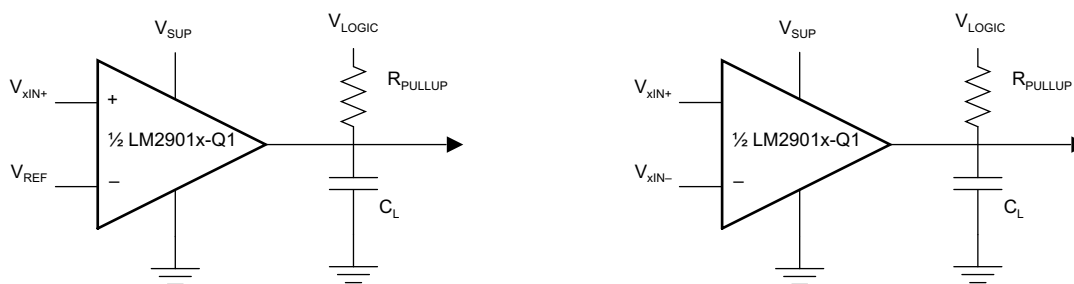
注

以下のアプリケーション情報は、TI の製品仕様に含まれるものではなく、TI ではその正確性または完全性を保証いたしません。個々の目的に対する製品の適合性については、お客様の責任で判断していただくこととなります。お客様は自身の設計実装を検証しテストすることで、システムの機能を確認する必要があります。

8.1 Application Information

LM2901-Q1 family will typically be used to compare a single signal to a reference or two signals against each other. Many users take advantage of the open drain output to drive the comparison logic output to a logic voltage level to an MCU or logic device. The wide supply range and high voltage capability makes LM2901-Q1 optimal for level shifting to a higher or lower voltage.

8.2 Typical Application



Copyright © 2016, Texas Instruments Incorporated

図 8-1. Single-Ended and Differential Comparator Configurations

8.2.1 Design Requirements

For this design example, use the parameters listed in 表 8-1 as the input parameters.

表 8-1. Design Parameters

PARAMETER	EXAMPLE VALUE
Input voltage range	0 V to $V_{SUP} - 1.5$ V
Supply voltage	2 V to 36 V
Logic supply voltage	2 V to 36 V
Output current (R_{PULLUP})	1 μ A to 20 mA
Input overdrive voltage	100 mV
Reference voltage	2.5 V
Load capacitance (C_L)	15 pF

8.2.2 Detailed Design Procedure

8.2.2.1 Input Voltage Range

When choosing the input voltage range, the input common mode voltage range (V_{ICR}) must be taken in to account. If temperature operation is above or below 25°C the V_{ICR} can range from 0 V to $V_{CC-} - 2.0$ V. This limits the input voltage range to as high as $V_{CC-} - 2.0$ V and as low as 0 V. Operation outside of this range can yield incorrect comparisons.

Below is a list of input voltage situation and their outcomes:

1. When both IN- and IN+ are both within the common mode range:
 - a. If IN- is higher than IN+ and the offset voltage, the output is low and the output transistor is sinking current

- b. If IN- is lower than IN+ and the offset voltage, the output is high impedance and the output transistor is not conducting
- 2. When IN- is higher than common mode and IN+ is within common mode, the output is low and the output transistor is sinking current
- 3. When IN+ is higher than common mode and IN- is within common mode, the output is high impedance and the output transistor is not conducting
- 4. When IN- and IN+ are both higher than common mode, the output is low and the output transistor is sinking current. The "B" version output will go high.

8.2.2.2 Minimum Overdrive Voltage

The overdrive voltage is the differential voltage produced between the positive and negative inputs of the comparator over the offset voltage (V_{IO}). To make an accurate comparison the overdrive voltage (V_{OD}) must be higher than the input offset voltage (V_{IO}). The overdrive voltage can also determine the response time of the comparator, with the response time decreasing as the overdrive increases. [Fig 8-2](#) and [Fig 8-3](#) show positive and negative response times with respect to overdrive voltage.

8.2.2.3 Output and Drive Current

Output current is determined by the load/pull-up resistance and logic/pull-up voltage. The output current will produce an output low voltage (V_{OL}) which is proportional to the output current. Use [Fig 6-19](#), [Fig 6-20](#), and [Fig 6-21](#) to determine V_{OL} based on the output current.

The output current can also effect the transient response. More will be explained in the next section.

8.2.2.4 Response Time

The transient response can be determined by the load capacitance (C_L), load or pullup resistance (R_{PULLUP}), and equivalent collector-emitter resistance (R_{CE}).

Use [Eq 1](#) and [Eq 2](#) to calculate the approximate values of the rise time (t_r) and fall time (t_f).

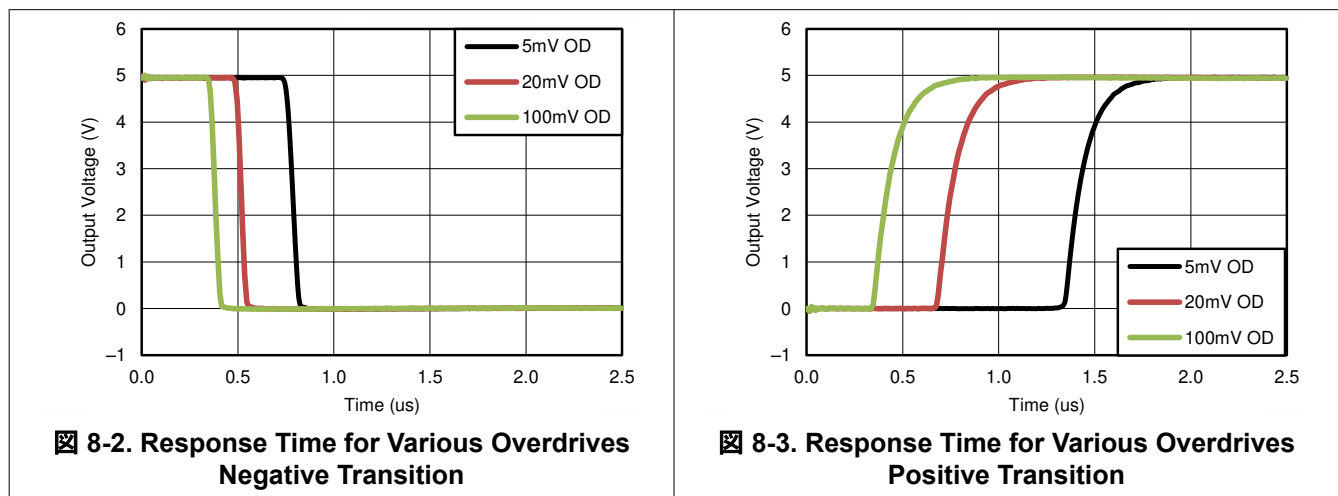
$$t_P \approx R_{PULLUP} \times C_L \tag{1}$$

$$t_N \approx R_{CE} \times C_L \tag{2}$$

To find the value of R_{CE} , use the slope of [Fig 6-35](#) in the linear region at the desired temperature, or divide V_{OL} by I_O .

8.2.3 Application Curves

The following curves were generated with 5 V on V_{CC} and V_{LOGIC} , $R_{PULLUP} = 5.1 \text{ k}\Omega$, and 50-pF scope probe.



9 Power Supply Recommendations

For fast response and comparison applications with noisy or AC inputs, TI recommends using a bypass capacitor on the supply pin to reject any variation on the supply voltage. This variation can take away from some of the input common mode range of the comparator and create an inaccurate comparison.

10 Layout

10.1 Layout Guidelines

For accurate comparator applications without hysteresis it is important maintain a stable power supply with minimized noise and glitches, which can affect the high level input common mode voltage range. In order to achieve this, it is best to add a bypass capacitor between the supply voltage and ground. This should be implemented on the positive power supply and negative supply (if available).

10.2 Layout Example

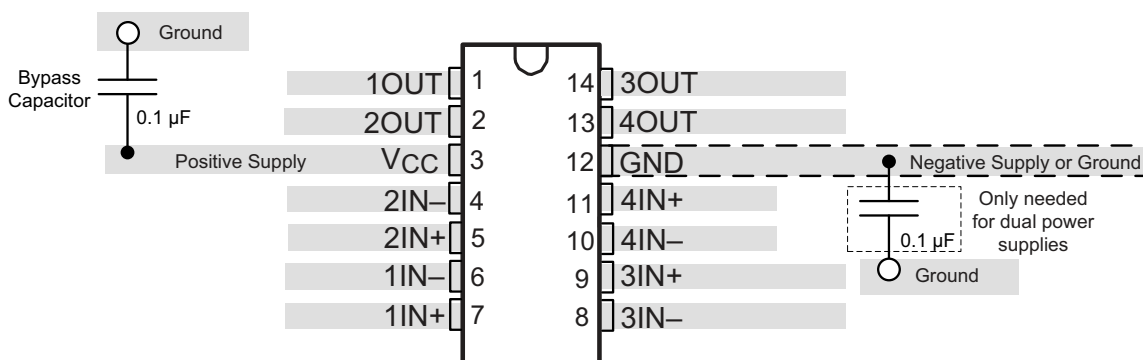


FIG 10-1. LM2901x-Q1 Layout Example

11 Device and Documentation Support

11.1 Documentation Support

11.1.1 Related Documentation

For related documentation, see the following:

TL331-Q1 *Single Differential Comparator*, [SLVS969](#)

11.2 Related Links

The table below lists quick access links. Categories include technical documents, support and community resources, tools and software, and quick access to sample or buy.

表 11-1. Related Links

PARTS	PRODUCT FOLDER	SAMPLE & BUY	TECHNICAL DOCUMENTS	TOOLS & SOFTWARE	SUPPORT & COMMUNITY
LM2901-Q1	Click here	Click here	Click here	Click here	Click here
LM2901V-Q1	Click here	Click here	Click here	Click here	Click here
LM2901AV-Q1	Click here	Click here	Click here	Click here	Click here
LM2901B-Q1	Click here	Click here	Click here	Click here	Click here

11.3 Trademarks

すべての商標は、それぞれの所有者に帰属します。

11.4 静電気放電に関する注意事項



この IC は、ESD によって破損する可能性があります。テキサス・インスツルメンツは、IC を取り扱う際には常に適切な注意を払うことを推奨します。正しい取り扱いおよび設置手順に従わない場合、デバイスを破損するおそれがあります。

ESD による破損は、わずかな性能低下からデバイスの完全な故障まで多岐にわたります。精密な IC の場合、パラメータがわずかに変化するだけで公表されている仕様から外れる可能性があるため、破損が発生しやすくなっています。

11.5 用語集

[テキサス・インスツルメンツ用語集](#)

この用語集には、用語や略語の一覧および定義が記載されています。

12 Mechanical, Packaging, and Orderable Information

The following pages include mechanical, packaging, and orderable information. This information is the most current data available for the designated devices. This data is subject to change without notice and revision of this document. For browser-based versions of this data sheet, refer to the left-hand navigation.

PACKAGING INFORMATION

Orderable Device	Status (1)	Package Type	Package Drawing	Pins	Package Qty	Eco Plan (2)	Lead finish/ Ball material (6)	MSL Peak Temp (3)	Op Temp (°C)	Device Marking (4/5)	Samples
LM2901AVQDRG4Q1	OBSOLETE	SOIC	D	14		TBD	Call TI	Call TI	-40 to 125	2901AVQ	
LM2901AVQDRQ1	ACTIVE	SOIC	D	14	2500	RoHS & Green	NIPDAU	Level-1-260C-UNLIM	-40 to 125	2901AVQ	Samples
LM2901AVQPWRG4Q1	ACTIVE	TSSOP	PW	14	2000	RoHS & Green	NIPDAU	Level-1-260C-UNLIM	-40 to 125	2901AVQ	Samples
LM2901AVQPWRQ1	ACTIVE	TSSOP	PW	14	2000	RoHS & Green	NIPDAU	Level-1-260C-UNLIM	-40 to 125	2901AVQ	Samples
LM2901BQDRQ1	ACTIVE	SOIC	D	14	3000	RoHS & Green	NIPDAU	Level-1-260C-UNLIM	-40 to 125	LM2901BQ	Samples
LM2901BQPWRQ1	ACTIVE	TSSOP	PW	14	3000	RoHS & Green	NIPDAU	Level-1-260C-UNLIM	-40 to 125	2901BQ	Samples
LM2901BWRTERQ1	ACTIVE	WQFN	RTE	16	5000	RoHS & Green	NIPDAU	Level-1-260C-UNLIM	-40 to 125	2901BQ	Samples
LM2901QDRG4Q1	OBSOLETE	SOIC	D	14		TBD	Call TI	Call TI	-40 to 125	2901Q1	
LM2901QDRQ1	ACTIVE	SOIC	D	14	2500	RoHS & Green	NIPDAU	Level-1-260C-UNLIM	-40 to 125	2901Q1	Samples
LM2901QPWRG4Q1	ACTIVE	TSSOP	PW	14	2000	RoHS & Green	NIPDAU	Level-1-260C-UNLIM	-40 to 125	2901Q1	Samples
LM2901QPWRQ1	ACTIVE	TSSOP	PW	14	2000	RoHS & Green	NIPDAU	Level-1-260C-UNLIM	-40 to 125	2901Q1	Samples
LM2901VQDRG4Q1	OBSOLETE	SOIC	D	14		TBD	Call TI	Call TI	-40 to 125	2901VQ1	
LM2901VQDRQ1	ACTIVE	SOIC	D	14	2500	RoHS & Green	NIPDAU	Level-1-260C-UNLIM	-40 to 125	2901VQ1	Samples
LM2901VQPWRG4Q1	ACTIVE	TSSOP	PW	14	2000	RoHS & Green	NIPDAU	Level-1-260C-UNLIM	-40 to 125	2901VQ	Samples
LM2901VQPWRQ1	ACTIVE	TSSOP	PW	14	2000	RoHS & Green	NIPDAU	Level-1-260C-UNLIM	-40 to 125	2901VQ	Samples

(1) The marketing status values are defined as follows:

ACTIVE: Product device recommended for new designs.

LIFEBUY: TI has announced that the device will be discontinued, and a lifetime-buy period is in effect.

NRND: Not recommended for new designs. Device is in production to support existing customers, but TI does not recommend using this part in a new design.

PREVIEW: Device has been announced but is not in production. Samples may or may not be available.

OBSOLETE: TI has discontinued the production of the device.

(2) **RoHS:** TI defines "RoHS" to mean semiconductor products that are compliant with the current EU RoHS requirements for all 10 RoHS substances, including the requirement that RoHS substance do not exceed 0.1% by weight in homogeneous materials. Where designed to be soldered at high temperatures, "RoHS" products are suitable for use in specified lead-free processes. TI may reference these types of products as "Pb-Free".

RoHS Exempt: TI defines "RoHS Exempt" to mean products that contain lead but are compliant with EU RoHS pursuant to a specific EU RoHS exemption.

Green: TI defines "Green" to mean the content of Chlorine (Cl) and Bromine (Br) based flame retardants meet JS709B low halogen requirements of ≤ 1000 ppm threshold. Antimony trioxide based flame retardants must also meet the ≤ 1000 ppm threshold requirement.

(3) MSL, Peak Temp. - The Moisture Sensitivity Level rating according to the JEDEC industry standard classifications, and peak solder temperature.

(4) There may be additional marking, which relates to the logo, the lot trace code information, or the environmental category on the device.

(5) Multiple Device Markings will be inside parentheses. Only one Device Marking contained in parentheses and separated by a "~" will appear on a device. If a line is indented then it is a continuation of the previous line and the two combined represent the entire Device Marking for that device.

(6) Lead finish/Ball material - Orderable Devices may have multiple material finish options. Finish options are separated by a vertical ruled line. Lead finish/Ball material values may wrap to two lines if the finish value exceeds the maximum column width.

Important Information and Disclaimer: The information provided on this page represents TI's knowledge and belief as of the date that it is provided. TI bases its knowledge and belief on information provided by third parties, and makes no representation or warranty as to the accuracy of such information. Efforts are underway to better integrate information from third parties. TI has taken and continues to take reasonable steps to provide representative and accurate information but may not have conducted destructive testing or chemical analysis on incoming materials and chemicals. TI and TI suppliers consider certain information to be proprietary, and thus CAS numbers and other limited information may not be available for release.

In no event shall TI's liability arising out of such information exceed the total purchase price of the TI part(s) at issue in this document sold by TI to Customer on an annual basis.

OTHER QUALIFIED VERSIONS OF LM2901-Q1, LM2901AV-Q1, LM2901B-Q1, LM2901V-Q1 :

- Catalog : [LM2901](#), [LM2901AV](#), [LM2901B](#), [LM2901V](#)

NOTE: Qualified Version Definitions:

- Catalog - TI's standard catalog product

TAPE AND REEL INFORMATION

QUADRANT ASSIGNMENTS FOR PIN 1 ORIENTATION IN TAPE


*All dimensions are nominal

Device	Package Type	Package Drawing	Pins	SPQ	Reel Diameter (mm)	Reel Width W1 (mm)	A0 (mm)	B0 (mm)	K0 (mm)	P1 (mm)	W (mm)	Pin1 Quadrant
LM2901AVQPWRG4Q1	TSSOP	PW	14	2000	330.0	12.4	6.9	5.6	1.6	8.0	12.0	Q1
LM2901AVQPWRQ1	TSSOP	PW	14	2000	330.0	12.4	6.9	5.6	1.6	8.0	12.0	Q1
LM2901BQDRQ1	SOIC	D	14	3000	330.0	16.4	6.5	9.0	2.1	8.0	16.0	Q1
LM2901BQPWRQ1	TSSOP	PW	14	3000	330.0	12.4	6.9	5.6	1.6	8.0	12.0	Q1
LM2901BWRTERQ1	WQFN	RTE	16	5000	330.0	12.4	3.3	3.3	1.1	8.0	12.0	Q2
LM2901QPWRG4Q1	TSSOP	PW	14	2000	330.0	12.4	6.9	5.6	1.6	8.0	12.0	Q1
LM2901QPWRQ1	TSSOP	PW	14	2000	330.0	12.4	6.9	5.6	1.6	8.0	12.0	Q1
LM2901VQPWRG4Q1	TSSOP	PW	14	2000	330.0	12.4	6.9	5.6	1.6	8.0	12.0	Q1
LM2901VQPWRQ1	TSSOP	PW	14	2000	330.0	12.4	6.9	5.6	1.6	8.0	12.0	Q1

TAPE AND REEL BOX DIMENSIONS


*All dimensions are nominal

Device	Package Type	Package Drawing	Pins	SPQ	Length (mm)	Width (mm)	Height (mm)
LM2901AVQPWRG4Q1	TSSOP	PW	14	2000	367.0	367.0	35.0
LM2901AVQPWRQ1	TSSOP	PW	14	2000	356.0	356.0	35.0
LM2901BQDRQ1	SOIC	D	14	3000	356.0	356.0	35.0
LM2901BQPWRQ1	TSSOP	PW	14	3000	356.0	356.0	35.0
LM2901BWRTERQ1	WQFN	RTE	16	5000	367.0	367.0	35.0
LM2901QPWRG4Q1	TSSOP	PW	14	2000	367.0	367.0	35.0
LM2901QPWRQ1	TSSOP	PW	14	2000	356.0	356.0	35.0
LM2901VQPWRG4Q1	TSSOP	PW	14	2000	367.0	367.0	35.0
LM2901VQPWRQ1	TSSOP	PW	14	2000	356.0	356.0	35.0

PW0014A



PACKAGE OUTLINE
TSSOP - 1.2 mm max height

SMALL OUTLINE PACKAGE



4220202/B 12/2023

NOTES:

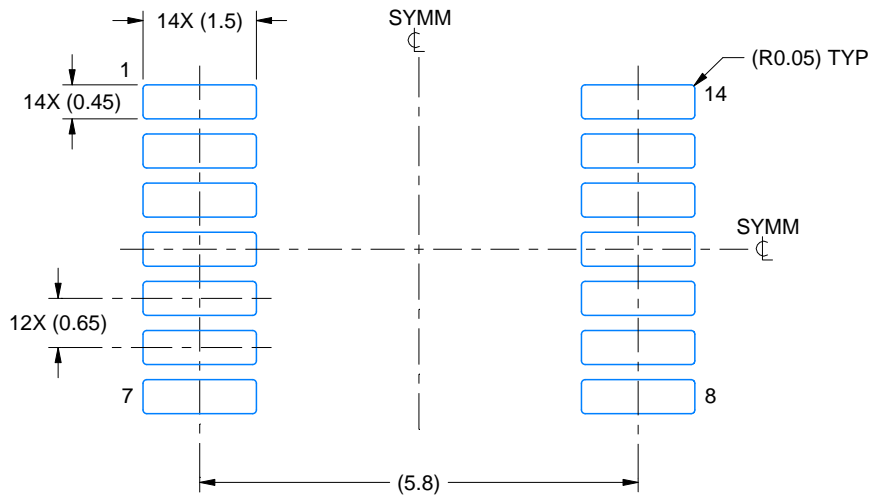
1. All linear dimensions are in millimeters. Any dimensions in parenthesis are for reference only. Dimensioning and tolerancing per ASME Y14.5M.
2. This drawing is subject to change without notice.
3. This dimension does not include mold flash, protrusions, or gate burrs. Mold flash, protrusions, or gate burrs shall not exceed 0.15 mm per side.
4. This dimension does not include interlead flash. Interlead flash shall not exceed 0.25 mm per side.
5. Reference JEDEC registration MO-153.

EXAMPLE BOARD LAYOUT

PW0014A

TSSOP - 1.2 mm max height

SMALL OUTLINE PACKAGE



LAND PATTERN EXAMPLE
EXPOSED METAL SHOWN
SCALE: 10X



4220202/B 12/2023

NOTES: (continued)

- 6. Publication IPC-7351 may have alternate designs.
- 7. Solder mask tolerances between and around signal pads can vary based on board fabrication site.

EXAMPLE STENCIL DESIGN

PW0014A

TSSOP - 1.2 mm max height

SMALL OUTLINE PACKAGE



SOLDER PASTE EXAMPLE
BASED ON 0.125 mm THICK STENCIL
SCALE: 10X

4220202/B 12/2023

NOTES: (continued)

8. Laser cutting apertures with trapezoidal walls and rounded corners may offer better paste release. IPC-7525 may have alternate design recommendations.
9. Board assembly site may have different recommendations for stencil design.

GENERIC PACKAGE VIEW

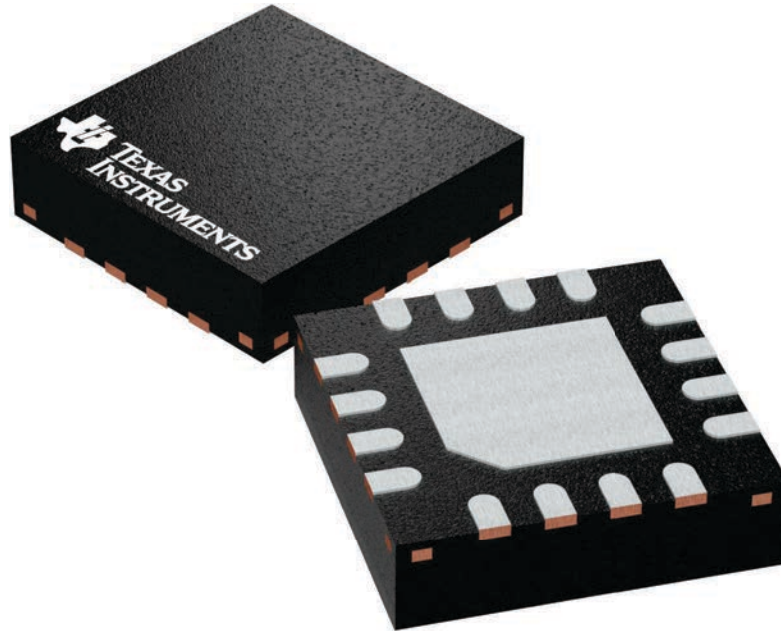
RTE 16

WQFN - 0.8 mm max height

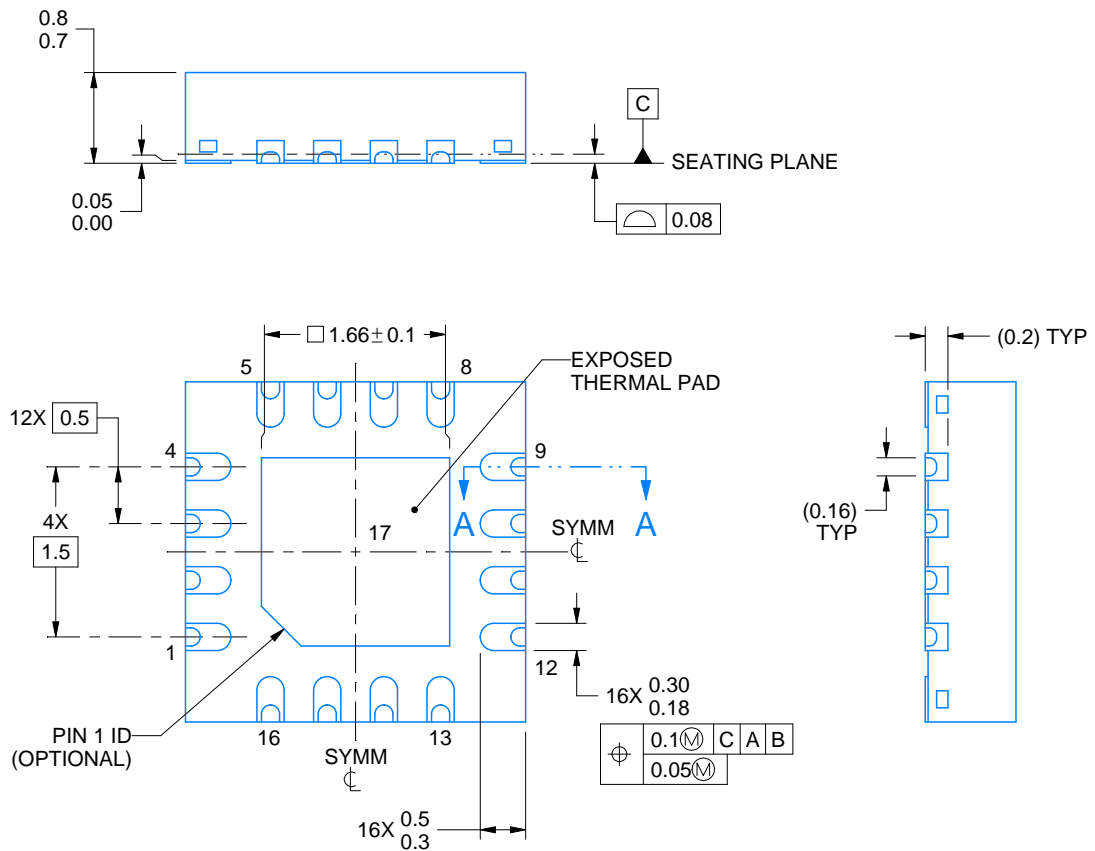
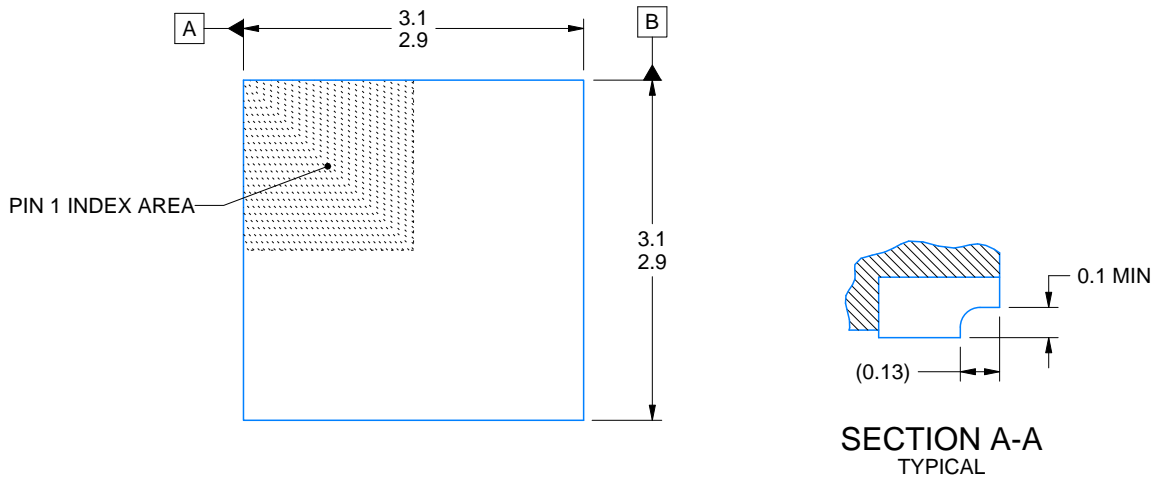
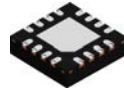
3 x 3, 0.5 mm pitch

PLASTIC QUAD FLATPACK - NO LEAD

This image is a representation of the package family, actual package may vary.
Refer to the product data sheet for package details.



4225944/A



4224938/C 03/2022

NOTES:

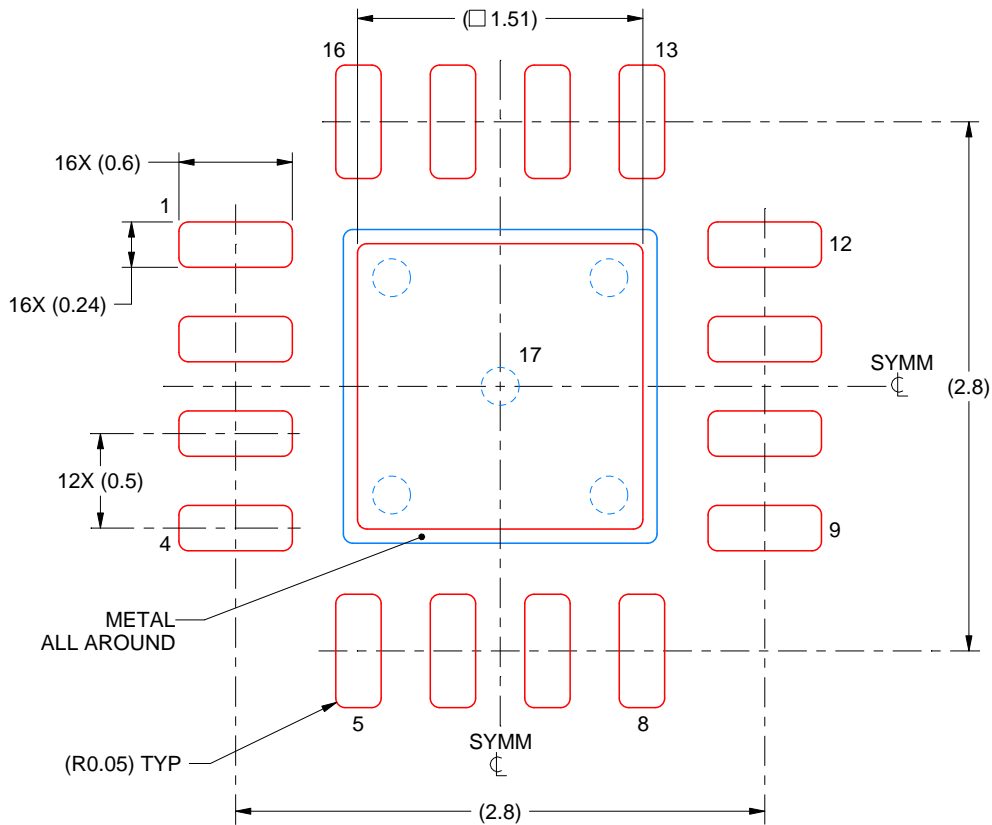
1. All linear dimensions are in millimeters. Any dimensions in parenthesis are for reference only. Dimensioning and tolerancing per ASME Y14.5M.
2. This drawing is subject to change without notice.
3. The package thermal pad must be soldered to the printed circuit board for thermal and mechanical performance.

EXAMPLE STENCIL DESIGN

RTE0016K

WQFN - 0.8 mm max height

PLASTIC QUAD FLATPACK - NO LEAD



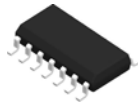
SOLDER PASTE EXAMPLE
BASED ON 0.125 mm THICK STENCIL

EXPOSED PAD 17:
84% PRINTED SOLDER COVERAGE BY AREA UNDER PACKAGE
SCALE:25X

4224938/C 03/2022

NOTES: (continued)

6. Laser cutting apertures with trapezoidal walls and rounded corners may offer better paste release. IPC-7525 may have alternate design recommendations.



D0014A

PACKAGE OUTLINE

SOIC - 1.75 mm max height

SMALL OUTLINE INTEGRATED CIRCUIT



4220718/A 09/2016

NOTES:

1. All linear dimensions are in millimeters. Dimensions in parenthesis are for reference only. Dimensioning and tolerancing per ASME Y14.5M.
2. This drawing is subject to change without notice.
3. This dimension does not include mold flash, protrusions, or gate burrs. Mold flash, protrusions, or gate burrs shall not exceed 0.15 mm, per side.
4. This dimension does not include interlead flash. Interlead flash shall not exceed 0.43 mm, per side.
5. Reference JEDEC registration MS-012, variation AB.

EXAMPLE BOARD LAYOUT

D0014A

SOIC - 1.75 mm max height

SMALL OUTLINE INTEGRATED CIRCUIT



LAND PATTERN EXAMPLE
SCALE:8X



SOLDER MASK DETAILS

4220718/A 09/2016

NOTES: (continued)

6. Publication IPC-7351 may have alternate designs.
7. Solder mask tolerances between and around signal pads can vary based on board fabrication site.

EXAMPLE STENCIL DESIGN

D0014A

SOIC - 1.75 mm max height

SMALL OUTLINE INTEGRATED CIRCUIT



SOLDER PASTE EXAMPLE
BASED ON 0.125 mm THICK STENCIL
SCALE:8X

4220718/A 09/2016

NOTES: (continued)

8. Laser cutting apertures with trapezoidal walls and rounded corners may offer better paste release. IPC-7525 may have alternate design recommendations.
9. Board assembly site may have different recommendations for stencil design.

重要なお知らせと免責事項

TI は、技術データと信頼性データ (データシートを含みます)、設計リソース (リファレンス・デザインを含みます)、アプリケーションや設計に関する各種アドバイス、Web ツール、安全性情報、その他のリソースを、欠陥が存在する可能性のある「現状のまま」提供しており、商品性および特定目的に対する適合性の黙示保証、第三者の知的財産権の非侵害保証を含むいかなる保証も、明示的または黙示的にかかわらず拒否します。

これらのリソースは、TI 製品を使用する設計の経験を積んだ開発者への提供を意図したものです。(1) お客様のアプリケーションに適した TI 製品の選定、(2) お客様のアプリケーションの設計、検証、試験、(3) お客様のアプリケーションに該当する各種規格や、その他のあらゆる安全性、セキュリティ、規制、または他の要件への確実な適合に関する責任を、お客様のみが単独で負うものとし、

上記の各種リソースは、予告なく変更される可能性があります。これらのリソースは、リソースで説明されている TI 製品を使用するアプリケーションの開発の目的でのみ、TI はその使用をお客様に許諾します。これらのリソースに関して、他の目的で複製することや掲載することは禁止されています。TI や第三者の知的財産権のライセンスが付与されている訳ではありません。お客様は、これらのリソースを自身で使用した結果発生するあらゆる申し立て、損害、費用、損失、責任について、TI およびその代理人を完全に補償するものとし、TI は一切の責任を拒否します。

TI の製品は、[TI の販売条件](#)、または [ti.com](#) やかかる TI 製品の関連資料などのいずれかを通じて提供する適用可能な条項の下で提供されています。TI がこれらのリソースを提供することは、適用される TI の保証または他の保証の放棄の拡大や変更を意味するものではありません。

お客様がいかなる追加条項または代替条項を提案した場合でも、TI はそれらに異議を唱え、拒否します。

郵送先住所 : Texas Instruments, Post Office Box 655303, Dallas, Texas 75265
Copyright © 2024, Texas Instruments Incorporated