

DAC8775 クワッド・チャンネル、16ビット、プログラマブル電流出力および電圧出力

デジタル/アナログ・コンバータ、適応型電力管理機能搭載

1 特長

- 出力電流:
 - 0mA~24mA, 3.5mA~23.5mA, 0mA~20mA, 4mA~20mA, ± 24 mA
- 出力電圧(20%の過電圧範囲あり/なし):
 - 0V~5V, 0V~10V, ± 5 V, ± 10 V
 - 0V~6V, 0V~12V, ± 6 V, ± 12 V
- 適応型電力管理
- 単一の、広い電圧範囲に対応した電源ピン(12V~36V)
- $\pm 0.1\%$ FSR総合未調整誤差(TUE)
- DNL: ± 1 LSB (最大値)
- 内蔵の5V基準電圧(最大10ppm/°C)
- 内蔵の5Vデジタル電源出力
- CRC/フレーム・エラー・チェック、ウォッチドッグ・タイマ
- サーマル・アラーム、オープン/短絡検出による高いシステム信頼性
- アラーム状況における安全動作
- 自動学習による負荷検出
- 広い温度範囲: -40°C~+125°C

2 アプリケーション

- 4mA~20mAの電流ループ
- アナログ出力モジュール
- プログラマブル・ロジック・コントローラ(PLC)
- ビル・オートメーション
- センサ・トランスミッタ
- プロセス制御

3 概要

DAC8775は、機能がすべて統合されたクワッド・チャンネルの高精度16ビット・デジタル/アナログ・コンバータ(DAC)で、アダプティブ電力管理を採用しており、産業用制御アプリケーションの要件を満たすよう設計されています。アダプティブ電力管理回路が有効なとき、チップの消費電力は最小化されます。電流出力にプログラムされているとき、電流出力ドライバの電源電圧は、電流出力ピンの連続的な電圧フィードバックに基づき、内蔵の昇降圧コンバータによって4.5V~32Vの範囲内にレギュレートされます。電圧出力にプログラムされているとき、この回路は電圧出力段用に、プログラム可能な電源電圧を生成します(± 15 V)。また、DAC8775には単一の電源ピンからデジタル電源(5V)を生成するためのLDOが搭載されています。

DAC8775にはHART (Highway Addressable Remote Transducer)信号インターフェイスも実装されており、電流出力に外部のHART信号を重ね合わせることができます。電流出力DACのスルー・レートはレジスタでプログラム可能です。このデバイスは、内蔵の降圧/昇圧コンバータを使用して、またはそれが無効化されているときは外部の電源を使用して、+12V~+36Vの単一の外部電源で動作できます。

製品情報(1)

| 型番 | パッケージ | 本体サイズ(公称) |
|---------|-----------|-----------------|
| DAC8775 | VQFN (72) | 10.00mmx10.00mm |

(1) 提供されているすべてのパッケージについては、データシートの末尾にある注文情報を参照してください。

ブロック図

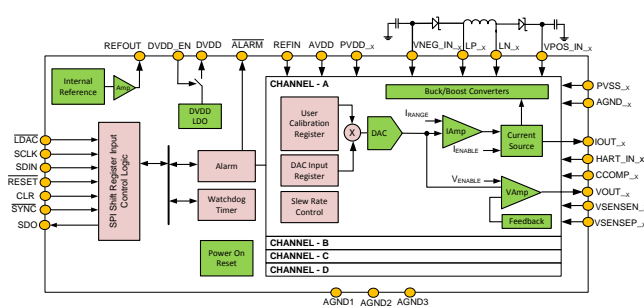

目次

| | | | | | |
|----------|--|----|-----------|---|----|
| 1 | 特長 | 1 | 8.4 | Device Functional Modes | 43 |
| 2 | アプリケーション | 1 | 8.5 | Register Maps | 47 |
| 3 | 概要 | 1 | 9 | Application and Implementation | 60 |
| 4 | 改訂履歴 | 2 | 9.1 | Application Information | 60 |
| 5 | Device Comparison Table | 3 | 9.2 | Typical Application | 63 |
| 6 | Pin Configuration and Functions | 3 | 10 | Power Supply Recommendations | 67 |
| 7 | Specifications | 6 | 11 | Layout | 69 |
| 7.1 | Absolute Maximum Ratings | 6 | 11.1 | Layout Guidelines | 69 |
| 7.2 | ESD Ratings | 6 | 11.2 | Layout Example | 70 |
| 7.3 | Recommended Operating Conditions | 6 | 12 | デバイスおよびドキュメントのサポート | 72 |
| 7.4 | Thermal Information | 7 | 12.1 | ドキュメントのサポート | 72 |
| 7.5 | Electrical Characteristics | 7 | 12.2 | ドキュメントの更新通知を受け取る方法 | 72 |
| 7.6 | Timing Requirements: Write and Readback Mode | 13 | 12.3 | コミュニティ・リソース | 72 |
| 7.7 | Typical Characteristics | 15 | 12.4 | 商標 | 72 |
| 8 | Detailed Description | 34 | 12.5 | 静電気放電に関する注意事項 | 72 |
| 8.1 | Overview | 34 | 12.6 | Glossary | 72 |
| 8.2 | Functional Block Diagram | 34 | 13 | メカニカル、パッケージ、および注文情報 | 73 |
| 8.3 | Feature Description | 34 | | | |

4 改訂履歴

| 日付 | 改訂内容 | 注 |
|---------|------|----|
| 2017年2月 | * | 初版 |

5 Device Comparison Table

| PRODUCT | RESOLUTION | DIFFERENTIAL NONLINEARITY (LSB) |
|---------|------------|---------------------------------|
| DAC8775 | 16 | ±1 |

6 Pin Configuration and Functions

RWF Package
72-Pin VQFN
Top View

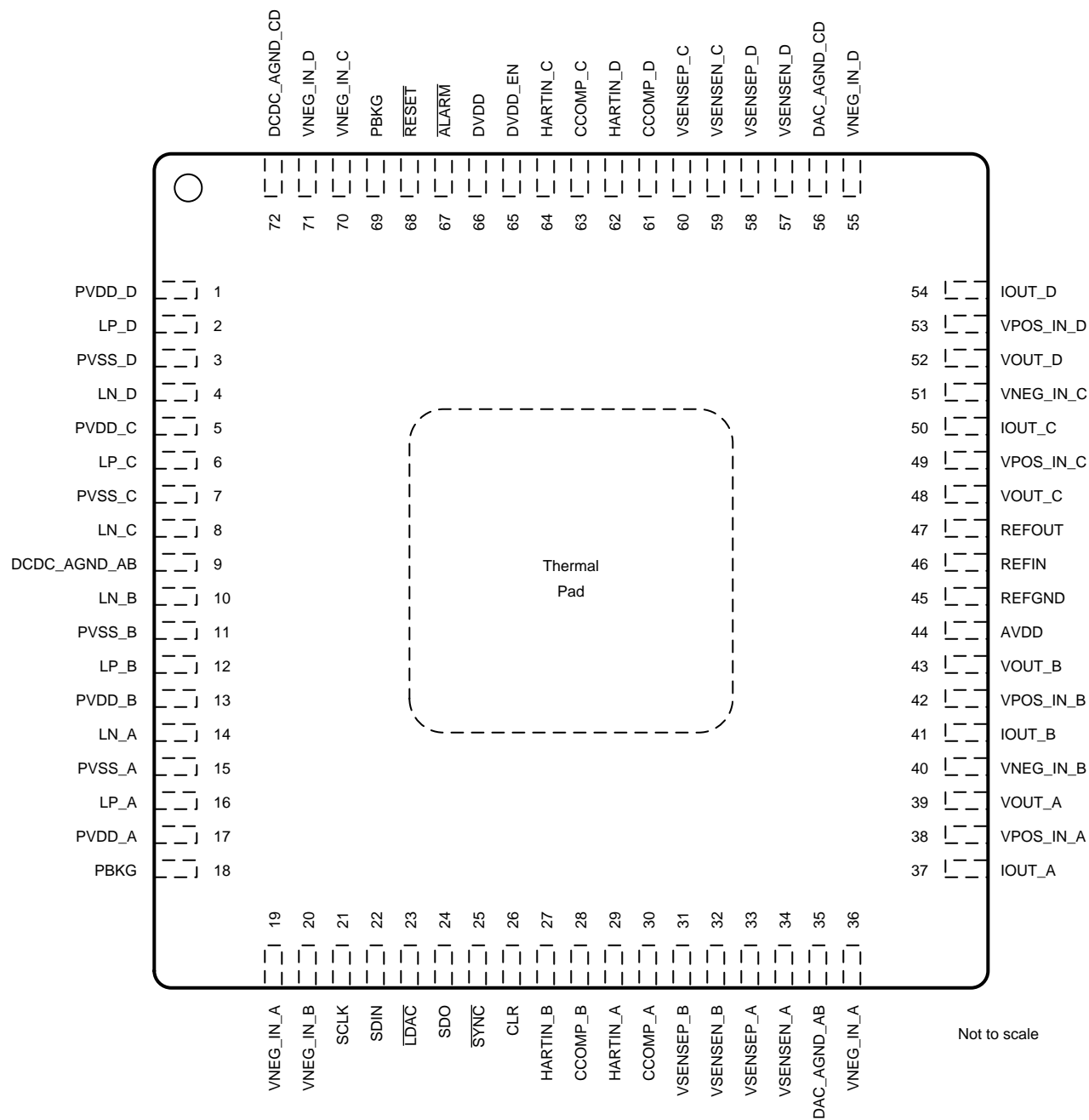

(1) Thermal pad should be connected to ground.

Pin Functions

| PIN | | DESCRIPTION |
|--------------------------|-----|---|
| NAME | NO. | |
| PVDD_D | 1 | Buck-Boost Converter power switch supply D |
| LP_D | 2 | External Inductor terminal - positive D |
| PVSS_D | 3 | Ground for Buck-Boost converter switches D |
| LN_D | 4 | External Inductor terminal - negative D |
| PVDD_C | 5 | Buck-Boost Converter power switch supply C |
| LP_C | 6 | External Inductor terminal - positive C |
| PVSS_C | 7 | Ground for Buck-Boost converter switches C |
| LN_C | 8 | External Inductor terminal - negative C |
| DCDC_AGND_AB | 9 | Analog GND Buck-Boost converter Channels A and B |
| LN_B | 10 | External Inductor terminal - negative B |
| PVSS_B | 11 | Ground for Buck-Boost converter switches B |
| LP_B | 12 | External Inductor terminal - positive B |
| PVDD_B | 13 | Buck-Boost Converter power switch supply B |
| LN_A | 14 | External Inductor terminal - negative A |
| PVSS_A | 15 | Ground for Buck-Boost converter switches A |
| LP_A | 16 | External Inductor terminal - positive A |
| PVDD_A | 17 | Buck-Boost Converter power switch supply A |
| PBKG | 18 | Chip substrate, connect to 0 V |
| VNEG_IN_A | 19 | Negative power supply for VOUT_A and IOUT_A |
| VNEG_IN_B | 20 | Negative power supply for VOUT_B and IOUT_A |
| SCLK | 21 | Serial clock input of serial peripheral interface (SPI™). Data can be transferred at rates up to 25 MHz. Schmitt-Trigger logic input. |
| SDIN | 22 | Serial data input. Data are clocked into the 24-bit input shift register on the falling edge of the serial clock input. Schmitt-Trigger logic input. |
| $\overline{\text{LDAC}}$ | 23 | Load DAC latch control input. A logic low on this pin loads the input shift register data into the DAC register and updates the DAC output. |
| SDO | 24 | Serial data output. Data are valid on the falling edge of SCLK. |
| $\overline{\text{SYNC}}$ | 25 | SPI bus chip select input (active low). Data bits are not clocked into the serial shift register unless SYNC is low. When SYNC is high, SDO is in high-impedance status. |
| CLR | 26 | Level Triggered clear pin (Active High). Clears all DAC channel to zero code or mid code (see DAC clear section) |
| HARTIN_B | 27 | Input pin for HART modulation. for IOUT_B |
| CCOMP_B | 28 | External compensation capacitor connection pin for VOUT_B . Addition of the external capacitor improves the stability with high capacitive loads at the VOUT_B pin by reducing the bandwidth of the output amplifier at the expense of increased settling time. |
| HARTIN_A | 29 | Input pin for HART modulation. for IOUT_A |
| CCOMP_A | 30 | External compensation capacitor connection pin for VOUT_A . Addition of the external capacitor improves the stability with high capacitive loads at the VOUT_A pin by reducing the bandwidth of the output amplifier at the expense of increased settling time. |
| VSENSEP_B | 31 | Sense output pin for the positive voltage output (channel B) load connection. |
| VSENSEN_B | 32 | Sense output pin for the negative voltage output (channel B) load connection. |
| VSENSEP_A | 33 | Sense output pin for the positive voltage output (channel A) load connection. |
| VSENSEN_A | 34 | Sense output pin for the negative voltage output (channel A) load connection. |
| DAC_AGND_AB | 35 | Analog GND DAC Channels A and B |
| VNEG_IN_A | 36 | Negative power supply for VOUT_A and IOUT_A |
| IOUT_A | 37 | Current Output Pin (Channel A) |
| VPOS_IN_A | 38 | Positive power supply for VOUT_A and IOUT_A |
| VOUT_A | 39 | Voltage Output Pin (Channel A) |
| VNEG_IN_B | 40 | Negative power supply for VOUT_B and IOUT_B |

Pin Functions (continued)

| PIN | | DESCRIPTION |
|--------------|-----|---|
| NAME | NO. | |
| IOUT_B | 41 | Current Output Pin (Channel B) |
| VPOS_IN_B | 42 | Positive power supply for VOUT_B and IOUT_B |
| VOUT_B | 43 | Voltage Output Pin (Channel B) |
| AVDD | 44 | Power supply for all analog circuitry of the device except buck-boost converters and output amplifiers |
| REFGND | 45 | Reference ground |
| REFIN | 46 | Reference input |
| REFOUT | 47 | Internal reference output. Connects to REFIN when using internal reference. |
| VOUT_C | 48 | Voltage Output Pin (Channel C) |
| VPOS_IN_C | 49 | Positive power supply for VOUT_C and IOUT_C |
| IOUT_C | 50 | Current Output Pin (Channel C) |
| VNEG_IN_C | 51 | Negative power supply for VOUT_C and IOUT_C |
| VOUT_D | 52 | Voltage Output Pin (Channel D) |
| VPOS_IN_D | 53 | Positive power supply for VOUT_D and IOUT_D |
| IOUT_D | 54 | Current Output Pin (Channel D) |
| VNEG_IN_D | 55 | Negative power supply for VOUT_D and IOUT_D |
| DAC_AGND_CD | 56 | Analog GND DAC Channels C and D |
| VSENSE_D | 57 | Sense output pin for the negative voltage output (channel D) load connection. |
| VSENSEP_D | 58 | Sense output pin for the positive voltage output (channel D) load connection. |
| VSENSE_C | 59 | Sense output pin for the negative voltage output (channel C) load connection. |
| VSENSEP_C | 60 | Sense output pin for the positive voltage output (channel C) load connection. |
| CCOMP_D | 61 | External compensation capacitor connection pin for VOUT_D . Addition of the external capacitor improves the stability with high capacitive loads at the VOUT_D pin by reducing the bandwidth of the output amplifier at the expense of increased settling time. |
| HARTIN_D | 62 | Input pin for HART modulation. for IOUT_D |
| CCOMP_C | 63 | External compensation capacitor connection pin for VOUT_C . Addition of the external capacitor improves the stability with high capacitive loads at the VOUT_C pin by reducing the bandwidth of the output amplifier at the expense of increased settling time. |
| HARTIN_C | 64 | Input pin for HART modulation. for IOUT_C |
| DVDD_EN | 65 | Internal power-supply enable pin. Connect this pin to PBKG to disable the internal DVDD, or leave this pin unconnected to enable the internal DVDD. When this pin is connected to PBKG, an external supply must be connected to the DVDD pin. |
| DVDD | 66 | Digital Supply pin (Input/Output) Internal DVDD enabled when DVDD_EN is floating, External DVDD must be supplied when DVDD_EN is connected to PBKG |
| ALARM | 67 | ALARM pin. Open drain output. External pull-up resistor required (10 kΩ). The pin goes low (active) when the ALARM condition is detected on any of the outputs (OUT_A through OUT_D) (open circuit, over temperature, watchdog timeout, and others). |
| RESET | 68 | Reset input (active low). Logic low on this pin causes the device to perform a reset. A hardware reset must be issued using this pin after power up. |
| PBKG | 69 | Chip substrate, connect to 0 V |
| VNEG_IN_C | 70 | Negative power supply for VOUT_C |
| VNEG_IN_D | 71 | Negative power supply for VOUT_D |
| DCDC_AGND_CD | 72 | Analog GND Buck-Boost converter Channels C and D |

7 Specifications

7.1 Absolute Maximum Ratings

over operating free-air temperature range (unless otherwise noted)⁽¹⁾

| | | MIN | MAX | UNIT |
|--|--|-----------|--------------------------------|------|
| Input voltage | PVDD_x/AVDD to PBKG | -0.3 | 40 | V |
| | PVSS_x/REFGND/DCDC_AGND_x/DAC_AGND_x to PBKG | -0.3 | 0.3 | |
| | VPOS_IN_x to VNEG_IN_x | -0.3 | 40 | |
| | VPOS_IN_x to PBKG | -0.3 | 33 | |
| | VNEG_IN_x to PBKG | -20 | 0.3 | |
| | VSENSE_x to PBKG | VNEG_IN_x | VPOS_IN_x | |
| | VSENSEP_x to PBKG | VNEG_IN_x | VPOS_IN_x | |
| | DVDD to PBKG | -0.3 | 6 | |
| | REFOUT/REFIN to PBKG | -0.3 | 6 | |
| | Digital input voltage to PBKG | -0.3 | DVDD+0.3 | |
| Output voltage | VOUT_x to PBKG | VNEG_IN_x | VPOS_IN_x | V |
| | IOUT_x to PBKG | VNEG_IN_x | VPOS_IN_x | |
| | SDO, ALARM to PBKG | -0.3 | DVDD+0.3 | |
| Input current | Current into any digital input pin | -10 | 10 | mA |
| Power dissipation | | | $(T_{Jmax} - T_A)/\theta_{JA}$ | W |
| Operating junction temperature, T _J | | -40 | 150 | °C |
| Junction temperature range, T _{Jmax} | | | 150 | |
| Storage temperature, T _{stg} | | -65 | 150 | |

(1) Stresses beyond those listed under Absolute Maximum Ratings may cause permanent damage to the device. These are stress ratings only, which do not imply functional operation of the device at these or any other conditions beyond those indicated under Recommended Operating Conditions. Exposure to absolute-maximum-rated conditions for extended periods may affect device reliability.

7.2 ESD Ratings

| | | VALUE | UNIT |
|--------------------|--|-------|------|
| V _(ESD) | Electrostatic discharge | | V |
| | Human body model (HBM), per ANSI/ESDA/JEDEC JS-001, all pins ⁽¹⁾ | ±2000 | |
| | Charged device model (CDM), per JEDEC specification JESD22-C101, all pins ⁽²⁾ | ±500 | |

(1) JEDEC document JEP155 states that 500-V HBM allows safe manufacturing with a standard ESD control process.

(2) JEDEC document JEP157 states that 250-V CDM allows safe manufacturing with a standard ESD control process.

7.3 Recommended Operating Conditions

over operating free-air temperature range (unless otherwise noted)

| | | MIN | NOM | MAX | UNIT |
|---|--|-----|-----|-----|------|
| POWER SUPPLY | | | | | |
| PVDD_x/AVDD_x to PBKG/PVSS_x ⁽¹⁾ | Positive supply voltage to ground range | 12 | | 36 | V |
| VPOS_IN_x to PBKG ⁽¹⁾ | Positive supply voltage to ground range | 12 | | 33 | V |
| VNEG_IN_x to PBKG ⁽¹⁾ | Negative supply voltage to substrate for current output mode | -18 | | 0 | V |
| | Negative supply voltage to substrate for voltage output mode | -18 | | -5 | V |
| VPOS_IN_x to VNEG_IN_x ⁽¹⁾ | | 12 | | 36 | V |
| VSENSE_x to PBKG | The minimum headroom spec for voltage output stage must be met | -7 | | 7 | V |

(1) The minimum headroom spec for voltage output stage and the compliance voltage for current output stage should be met. When Buck-Boost converter is enabled VPOS_IN_x/VNEG_IN_x are generated internally to meet headroom and compliance specs. When Buck-Boost converter is disabled VPOS_IN_x, AVDD, and PVDD must be tied together.

Recommended Operating Conditions (continued)

over operating free-air temperature range (unless otherwise noted)

| | | MIN | NOM | MAX | UNIT |
|--------------------------|-------------------------------------|------|-----|------|------|
| DVDD to PBKG | Digital supply voltage to substrate | 2.7 | | 5.5 | V |
| DIGITAL INPUTS | | | | | |
| V _{IH} | Input high voltage | 2 | | | V |
| V _{IL} | Input low voltage | | | 0.6 | V |
| REFERENCE INPUT | | | | | |
| REFIN to PBKG | Reference input to substrate | 4.95 | | 5.05 | V |
| TEMPERATURE RANGE | | | | | |
| T _A | Operating temperature | -40 | | 125 | °C |

7.4 Thermal Information

| THERMAL METRIC ⁽¹⁾ | | DAC8775 | | UNIT |
|-------------------------------|--|------------|--|------|
| | | RWF (VQFN) | | |
| | | 72 PINS | | |
| R _{θJA} | Junction-to-ambient thermal resistance | 21.7 | | °C/W |
| R _{θJC(top)} | Junction-to-case (top) thermal resistance | 3.3 | | °C/W |
| R _{θJB} | Junction-to-board thermal resistance | 1.9 | | °C/W |
| Ψ _{JT} | Junction-to-top characterization parameter | 0.1 | | °C/W |
| Ψ _{JB} | Junction-to-board characterization parameter | 1.9 | | °C/W |
| R _{θJC(bot)} | Junction-to-case (bottom) thermal resistance | 0.2 | | °C/W |

(1) For more information about traditional and new thermal metrics, see the [Semiconductor and IC Package Thermal Metrics](#) application report.

7.5 Electrical Characteristics

AVDD/PVDD_x/VPOS_IN_x = +15 V, VNEG_IN_x = -15 V, VSENSEN_x = PBKG = PVSS_x = 0 V, External DVDD = 2.7 V. VOUT : R_L = 1 kΩ, C_L = 200 pF, IOUT : R_L = 250 Ω; all specifications -40°C to +125°C, unless otherwise noted. REFIN= +5 V external, Buck-Boost Converter disabled unless otherwise stated

| PARAMETER | | TEST CONDITIONS | MIN | TYP | MAX | UNIT |
|-----------------------|--|------------------------------------|-------|-----|------|------------|
| CURRENT OUTPUT | | | | | | |
| IOUT | Output Current Ranges | | 0 | | 24 | mA |
| | | | 0 | | 20 | mA |
| | | | 3.5 | | 23.5 | mA |
| | | | -24 | | 24 | mA |
| | | | 4 | | 20 | mA |
| Accuracy | | | | | | |
| | Resolution | | 16 | | | Bits |
| INL | Relative Accuracy ⁽¹⁾ | All ranges except bipolar range | -12 | | 12 | LSB |
| | | Bipolar range only | -16 | | 16 | LSB |
| DNL | Differential Nonlinearity ⁽¹⁾ | Ensured monotonic | -1 | | 1 | LSB |
| TUE | Total Unadjusted Error ⁽¹⁾ | -40°C to +125°C | -0.14 | | 0.14 | %FSR |
| | | -40°C to +125°C, 4 to 20 mA | -0.4 | | 0.4 | %FSR |
| | | T _A = +25°C, 4 to 20 mA | -0.2 | | 0.2 | %FSR |
| | | T _A = +25°C | -0.12 | | 0.12 | %FSR |
| OE | Offset Error ⁽¹⁾ | -40°C to +125°C | -0.1 | | 0.1 | %FSR |
| | | T _A = +25°C | -0.05 | | 0.05 | %FSR |
| OE-TC | Offset Error Temperature Coefficient | -40°C to +125°C | | 4 | | ppm FSR/°C |

(1) For current output all ranges except ±24 mA, low code of 256d and a high code of 65535d are used, for ±24 mA range low code of 0d and a high code of 65535d. For voltage output, low code of 256d and a high code of 65535d are used

Electrical Characteristics (continued)

AVDD/PVDD_x/VPOS_IN_x = +15 V, VNEG_IN_x = -15 V, VSENSEN_x = PBKG = PVSS_x = 0 V, External DVDD = 2.7 V. VOUT : R_L = 1 kΩ, C_L = 200 pF, IOUT : R_L = 250 Ω; all specifications -40°C to +125°C, unless otherwise noted. REFIN= +5 V external, Buck-Boost Converter disabled unless otherwise stated

| PARAMETER | | TEST CONDITIONS | MIN | TYP | MAX | UNIT |
|-----------------------|---|--|------------------|-------|-----------------|------------|
| ZCE | Zero Code Error | -40°C to +125°C, 0x0000h into DAC | -15 | | 15 | μA |
| | | -40°C to +125°C, 0x0000h into DAC, 4 to 20 mA | -18 | | 18 | μA |
| | | T _A = 25°C, 0x0000h into DAC | | 1.2 | | m%FSR |
| | | T _A = 25°C, 0x0000h into DAC, 4 to 20 mA | | 1.8 | | m%FSR |
| ZCE-TC | Zero Code Error Temperature Coefficient | 0x0000h into DAC, -40°C to +125°C | | 4 | | ppm/°C |
| GE | Gain Error ⁽²⁾ | -40°C to +125°C | -0.125 | | 0.125 | %FSR |
| | | -40°C to +125°C, 4 to 20 mA | -0.25 | | 0.25 | %FSR |
| | | T _A = +25°C, 4 to 20 mA | -0.2 | | 0.2 | %FSR |
| | | T _A = +25°C | -0.12 | | 0.12 | %FSR |
| GE-TC | Gain Error Temperature Coefficient | -40°C to +125°C | | 3 | | ppm FSR/°C |
| PFSE | Positive Full Scale Error | 0xFFFFh into DAC, -40°C to +125°C | -0.125 | | 0.125 | %FSR |
| | | 0xFFFFh into DAC, -40°C to +125°C, 4 to 20 mA | -0.25 | | 0.25 | %FSR |
| | | 0xFFFFh into DAC, T _A = 25°C | | 0.016 | | %FSR |
| | | 0xFFFFh into DAC, T _A = 25°C, 4 to 20 mA | | 0.024 | | %FSR |
| NFSE | Negative Full Scale Error | 0x0000h into DAC, Bipolar range only, -40°C to +125°C | -0.125 | | 0.125 | %FSR |
| | | 0x0000h into DAC, Bipolar range only, T _A = 25°C | | 0.02 | | %FSR |
| PFSE-TC | Positive Full Scale Error Temperature Coefficient | | | 5 | | ppm FSR/°C |
| NFSE-TC | Negative Full Scale Error Temperature Coefficient | Bipolar range only | | 5 | | ppm FSR/°C |
| BPZE | Bipolar Zero Error | Bipolar range only, 0x8000h into DAC -40°C to +125°C | -0.05 | | 0.05 | %FSR |
| | | Bipolar range only, 0x8000h into DAC, T _A = +25°C | -0.02 | | 0.02 | %FSR |
| BPZE-TC | Bipolar Zero Error Temperature Coefficient | 0x8000h into DAC, -40°C to +125°C | | 4 | | ppm/°C |
| VCL | Compliance Voltage | Output = 24 mA | | | VPOS_I N_x-3 | V |
| | | Output = ±24 mA | VNEG_ IN_x +3 | | VPOS_I N_x-3 | V |
| R _L | Resistive Load | All except ±24 mA range | | | 1.2 | KΩ |
| | | ±24 mA range | | | 0.625 | |
| DC-PSRR | DC Power Supply Rejection Ratio | Code = 0x8000, 20 mA range | | 0.1 | | μA/V |
| Z _O | Output Impedance | Code = 0x8000 | | 10 | | MΩ |
| IOLEAK | Output Current Leakage | Iout is disabled or in power-down | | 1 | | nA |
| HART INTERFACE | | | | | | |
| VHART-IN | HART Input | | 400 | 500 | 600 | mVpp |
| | Corresponding Output | HART In = 500 mVpp 1.2 KHz | | 1 | | mApp |

(2) No load, DVDD supply ramps up before VPOS_IN_x, and VNEG_IN_x, ramp rate of VPOS_IN_x, and VNEG_IN_x limited to 18 V/msec

Electrical Characteristics (continued)

AVDD/PVDD_x/VPOS_IN_x = +15 V, VNEG_IN_x = -15 V, VSENSEN_x = PBKG = PVSS_x = 0 V, External DVDD = 2.7 V.
VOUT : R_L = 1 kΩ, C_L = 200 pF, IOUT : R_L = 250 Ω; all specifications -40°C to +125°C, unless otherwise noted. REFIN= +5 V external, Buck-Boost Converter disabled unless otherwise stated

| PARAMETER | | TEST CONDITIONS | MIN | TYP | MAX | UNIT |
|-----------------------|---|--|--------|-------|-------|------------|
| VOLTAGE OUTPUT | | | | | | |
| VOUT | Voltage Output Ranges (normal mode) | | 0 | | 5 | V |
| | | | 0 | | 10 | V |
| | | | -5 | | 5 | V |
| | | | -10 | | 10 | V |
| | Voltage Output Ranges (Overrange mode) | | 0 | | 6 | V |
| | | | 0 | | 12 | V |
| | | | -6 | | 6 | V |
| | | | -12 | | 12 | V |
| Accuracy | | | | | | |
| | Resolution | | 16 | | | Bits |
| INL | Relative Accuracy, INL ⁽¹⁾ | | -12 | | 12 | LSB |
| DNL | Differential Nonlinearity, DNL ⁽¹⁾ | Ensured monotonic | -1 | | 1 | LSB |
| TUE | Total Unadjusted Error, TUE ⁽¹⁾ | -40°C to +125°C, VOUT unloaded | -0.1 | ±0.05 | 0.1 | %FSR |
| | | T _A = +25°C, VOUT unloaded | -0.075 | | 0.075 | %FSR |
| ZCE | Zero Code Error ⁽³⁾ | Unipolar ranges only, VOUT unloaded, -40°C to +125°C | -2.5 | | 2.5 | mV |
| | | Unipolar ranges only, VOUT unloaded, T _A = 25°C | | 0.14 | | mV |
| ZCE-TC | Zero Code Error Temperature Coefficient | Unipolar ranges only, -40°C to +125°C | | 2 | | ppm FSR/°C |
| BPZE | Bipolar Zero Error | Bipolar range only, 0x8000h into DAC, -40°C to +125°C, VOUT unloaded | -0.03 | | 0.03 | %FSR |
| | | Bipolar range only, 0x8000h into DAC, T _A = +25°C, VOUT unloaded | -0.025 | | 0.025 | %FSR |
| BPZE-TC | Bipolar Zero Error Temperature Coefficient | Bipolar range only, 0x8000h into DAC, -40°C to +125°C, VOUT unloaded | | 1 | | ppm FSR/°C |
| GE | Gain Error ⁽¹⁾ | -40°C to +125°C, VOUT unloaded | -0.1 | | 0.1 | %FSR |
| | | T _A = +25°C, VOUT unloaded | -0.07 | | 0.07 | %FSR |
| GE-TC | Gain Error Temperature Coefficient | -40°C to +125°C | | 3 | | ppm FSR/°C |
| PFSE | Positive Full Scale Error | 0xFFFFh into DAC, -40°C to +125°C, VOUT unloaded | -0.1 | | 0.1 | %FSR |
| | | 0xFFFFh into DAC, T _A = 25°C, VOUT unloaded | | 0.03 | | %FSR |
| NFSE | Negative Full Scale Error ⁽³⁾ | Bipolar ranges only, 0x0000h into DAC, -40°C to +125°C, VOUT unloaded | -0.06 | | 0.06 | %FSR |
| | | Bipolar ranges only, 0x0000h into DAC, T _A = 25°C, VOUT unloaded | | 0.002 | | %FSR |
| PFSE-TC | Positive Full Scale Error Temperature Coefficient | VOUT unloaded, -40°C to +125°C | | 2 | | ppm FSR/°C |
| NFSE-TC | Negative Full Scale Error Temperature Coefficient | VOUT unloaded, -40°C to +125°C | | 2 | | ppm FSR/°C |
| Headroom | Headroom | Output unloaded, VPOS_IN_x with respect to VOUT_x, 0xFFFFh into DAC, No load | 0.5 | | | V |
| | | Output unloaded, VPOS_IN_x with respect to VOUT_x, 0xFFFFh into DAC, 1 kΩ load | 3 | | | V |

(3) DAC code at 0d, this error includes offset error of the DAC since the DAC is linear between 0d to 65535d

Electrical Characteristics (continued)

AVDD/PVDD_x/VPOS_IN_x = +15 V, VNEG_IN_x = -15 V, VSENSE_x = PBKG = PVSS_x = 0 V, External DVDD = 2.7 V. VOUT : R_L = 1 kΩ, C_L = 200 pF, IOUT : R_L = 250 Ω; all specifications -40°C to +125°C, unless otherwise noted. REFIN= +5 V external, Buck-Boost Converter disabled unless otherwise stated

| PARAMETER | | TEST CONDITIONS | MIN | TYP | MAX | UNIT |
|----------------------------------|--|---|------|------|------|-----------|
| Footroom | | Bipolar, ranges only, VNEG_IN_x with respect to VOUT_x, 0x0000h into DAC | 3 | | | V |
| | | Unipolar ranges only, VNEG_IN_x with respect to VOUT_x, 0x0000h into DAC | 5 | | | V |
| Short-Circuit Current | | SCLIM[1:0] = "00" (see register map) | 17 | | 23 | mA |
| | | SCLIM[1:0] = "01" (see register map) | 8 | | 11 | mA |
| | | SCLIM[1:0] = "10" (see register map) | 22 | | 28 | mA |
| | | SCLIM[1:0] = "11" (see register map) | 26 | | 34 | mA |
| R _L | Load | | 1 | | | kΩ |
| C _L | Capacitive Load Stability | R _L = Open | | | 20 | nF |
| | | R _L = 1 kΩ | | | 20 | nF |
| | | R _L = 1 kΩ with External compensation capacitor (150 pF) connected | | | 1 | μF |
| Z _O | DC Output Impedance | Voltage output enabled, VOUT = Mid Scale, UP10V range | | 0.01 | | Ω |
| | | Voltage output disabled (POC = '1') | | 50 | | MΩ |
| | | Voltage output disabled (POC = '0') | | 30 | | kΩ |
| ILEAK | Output Leakage (VOUT_x Pin) | Voltage output disabled (POC = '1') | | 1 | | nA |
| DC-PSRR | DC Power Supply Rejection Ratio | No output load | | 10 | | μV/V |
| | VSENSEP Impedance | VOUT enabled Mid-Scale UP10 | | 240 | | kΩ |
| | VSENSEN Impedance | VOUT enabled Mid-Scale UP10 | | 120 | | kΩ |
| EXTERNAL REFERENCE INPUT | | | | | | |
| IREF | External Reference Current | VOUT = Full scale, BP12V range, per channel | | 0.35 | | mA |
| | Reference Input Capacitance | | | 100 | | pF |
| INTERNAL REFERENCE OUTPUT | | | | | | |
| VREF | Reference Output | T _A = 25°C | 4.99 | | 5.01 | V |
| VREF-TC | Reference TC | T _A = -40°C to +125°C | -13 | | 13 | ppm/°C |
| | | T _A = -25°C to +125°C | -10 | | 10 | ppm/°C |
| TUE | DAC Voltage Output Total Unadjusted Error ⁽¹⁾ | -40°C to +125°C, VOUT_x unloaded, Internal reference enabled | | 0.2 | | %FSR |
| | DAC Current Output Total Unadjusted Error ⁽¹⁾ | -40°C to +125°C, Internal reference enabled | | 0.2 | | %FSR |
| | | -40°C to +125°C, Internal reference enabled, 4 mA to 20 mA range | | 0.5 | | %FSR |
| | Output Noise (0.1 Hz to 10 Hz) | T _A = 25°C | | 13 | | μV p-p |
| | Noise Spectral Density | At 10 kHz, At 25°C | | 200 | | nV/sqrtHz |
| C _L | Capacitive Load | | | | 600 | nF |
| I _L | Load Current | | | ±5 | | mA |
| | Short Circuit Current | Ref-Out shorted to PBKG | | 20 | | mA |
| | Load Regulation | Sourcing and Sinking, T _A = +25°C | | 5 | | μV/mA |
| | Line Regulation | T _A = +25°C | | 2 | | uV/V |
| BUCK BOOST CONVERTER | | | | | | |
| RON | Switch On Resistance | T _A = +25°C | | 3 | | Ω |
| ILEAK | Switch Leakage Current | T _A = +25°C | | 20 | | nA |
| L | Inductor | Between LP_x and LN_x | | 100 | | μH |

Electrical Characteristics (continued)

AVDD/PVDD_x/VPOS_IN_x = +15 V, VNEG_IN_x = -15 V, VSENSEN_x = PBKG = PVSS_x = 0 V, External DVDD = 2.7 V. VOUT : R_L = 1 kΩ, C_L = 200 pF, IOU_T : R_L = 250 Ω; all specifications -40°C to +125°C, unless otherwise noted. REFIN= +5 V external, Buck-Boost Converter disabled unless otherwise stated

| PARAMETER | | TEST CONDITIONS | MIN | TYP | MAX | UNIT |
|---------------------------|------------------------------------|--|----------|-----|-----|------|
| ILMAX | Peak Inductor Current | T _A = +25°C, PVDD = AVDD = 36 V, Buck-Boost Converter enabled | | | 0.5 | A |
| V _O | Output Voltage | VPOS_IN_x minimum | | 4 | | V |
| | | VPOS_IN_x maximum | | 32 | | V |
| V _O | Output Voltage | VNEG_IN_x minimum | | -18 | | V |
| | | VNEG_IN_x maximum | | -5 | | V |
| C _L | Load Capacitor | VPOS_IN_x and VNEG_IN_x | 10 | | | μF |
| | Start Up Time | After enabling VPOS_IN_x and VNEG_IN_x with 10 μF load capacitor on these pins | | 3 | | ms |
| DVDD LDO | | | | | | |
| V _O | Output Voltage | | | 5 | | V |
| ILOAD | Load Current | | | | 10 | mA |
| C _L | Load Capacitor | | | | 0.2 | nF |
| THERMAL ALARM | | | | | | |
| | Trip Point | | | 150 | | °C |
| | Hysteresis | | | 15 | | °C |
| DIGITAL INPUTS | | | | | | |
| | Hysteresis Voltage | | | 0.4 | | V |
| | Input Current | | -5 | | 5 | μA |
| | Input Current (DVDD_EN) | | -10 | | 10 | μA |
| | Pin Capacitance | Per pin | | 10 | | pF |
| DIGITAL OUTPUTS | | | | | | |
| SDO | | | | | | |
| V _{OL} | Output Low Voltage | Sinking 200 μA | | | 0.4 | V |
| V _{OH} | Output High Voltage | Sourcing 200 μA | DVDD-0.5 | | | V |
| I _{LEAK} | High Impedance Leakage | | -5 | | 5 | μA |
| | High Impedance Output Capacitance | | | 10 | | pF |
| ALARM | | | | | | |
| V _{OL} | Output Low Voltage | At 2.5 mA | | 0.4 | | V |
| I _{LEAK} | High Impedance Leakage | | | 50 | | μA |
| | High Impedance Output Capacitance | | | 10 | | pF |
| POWER REQUIREMENTS | | | | | | |
| IAVDD+IPVDD | Current Flowing into AVDD and PVDD | All Buck-Boost converter positive output enabled, IOU _T _x mode operation, All IOU _T channels enabled, 0 mA, PVDD = AVDD = 12 V, Internal reference, VNEG_IN_x = 0 V | | 5 | | mA |
| | | All IOU _T Active, 0 mA, 0 to 24 mA range, VNEG_IN_x = 0 V | | 3.5 | 5 | mA |
| IPVDD_x | Current Flowing into PVDD | Buck-Boost converter enabled, Peak current | | | 0.5 | A |
| | | Buck-Boost converter disabled | | 0.1 | | mA |
| IDVDD | Current Flowing into DVDD | All digital pins at DVDD, DVDD = 5.5 V | | 1.8 | | mA |
| IVPOS_IN_x | Current Flowing into VPOS_IN_x | IOU _T active, 0 mA, 0 to 24 mA range | | | 1.2 | mA |
| | | VOUT active, No load, 0 to 10 V range, Mid scale code | | | 3 | mA |

Electrical Characteristics (continued)

AVDD/PVDD_x/VPOS_IN_x = +15 V, VNEG_IN_x = -15 V, VSENSE_N_x = PBKG = PVSS_x = 0 V, External DVDD = 2.7 V. VOUT : R_L = 1 k Ω , C_L = 200 pF, IOU_T : R_L = 250 Ω ; all specifications -40°C to +125°C, unless otherwise noted. REFIN= +5 V external, Buck-Boost Converter disabled unless otherwise stated

| PARAMETER | | TEST CONDITIONS | MIN | TYP | MAX | UNIT |
|----------------------------|---|--|-----|------|-----|-------------|
| IVNEG_IN_x | Current Flowing into VNEG_IN_x | IOU _T active, 0 mA, \pm 24 mA range | | | 1.2 | mA |
| | | VOUT active, No load, 0 to 10 V range, Mid scale code | | | 3 | mA |
| PDISS | Power Dissipation (PVDD+AVDD) | All Buck-Boost converter positive output enabled, IOU _T _x mode operation, All IOU _T channels enabled, Rload = 1 Ω , 24 mA, PVDD = AVDD = 12 V, Internal reference, VNEG_IN_x = 0 V | | 0.86 | 1.1 | W |
| IVSENSE _P | Current Flowing into VSENSE _P | VOUT disabled | | | 40 | nA |
| IVSENSE _N | Current Flowing into VSENSE _N | VOUT disabled | | | 20 | nA |
| DYNAMIC PERFORMANCE | | | | | | |
| Voltage Output | | | | | | |
| T _{sett} | Output Voltage Settling Time | 0 to 10 V, to \pm 0.03% FSR RL = 1K CL = 200 pF | | 15 | | μ s |
| | | 0 to 5 V, to \pm 0.03% FSR RL = 1K CL = 200 pF | | 10 | | μ s |
| | | -5 to 5 V, to \pm 0.03% FSR RL = 1K CL = 200 pF | | 15 | | μ s |
| | | -10 to 10 V, to \pm 0.03% FSR RL = 1K CL = 200 pF | | 30 | | μ s |
| | Output Voltage Ripple | Buck-Boost converter enabled, 50 KHz, 20dB/decade filter on VPOS_IN_x | | 2 | | mVpp |
| SR | Slew Rate | R _L = 1K CL = 200 pF | | 1 | | V/ μ s |
| | Power-On Glitch Magnitude ⁽²⁾ | | | 0.1 | | V |
| | Power-off Glitch Magnitude ⁽⁴⁾ | | | 0.8 | | V |
| | Channel to Channel DC Crosstalk | Full scale swing on adjacent channel | | 2 | | m%FSR |
| | Code-to-Code Glitch | | | 0.15 | | μ V-sec |
| | Digital Feedthrough | | | 1 | | nV-sec |
| | Output Noise (0.1 Hz to 10 Hz bandwidth) | UP10V, Mid scale | | 0.1 | | LSB p-p |
| | Output Noise (100 kHz bandwidth) | UP10V, Mid scale | | 200 | | μ Vrms |
| | Output Noise Spectral Density | BP20V Measured at 10 kHz, Mid scale | | 200 | | nV/sqrtHz |
| AC-PSRR | AC Power Supply Rejection Ratio | 200 mV 50/60Hz Sine wave superimposed on power supply voltage. (AC analysis) | | -75 | | dB |
| Current Output | | | | | | |
| T _{sett} | Output Current Settling Time | 24 mA Step, to 0.1% FSR, no L | | 10 | | μ s |
| | | 24 mA Step, to 0.1% FSR, L = 1 mH, C _L = 22 nF | | 50 | | μ s |
| | Output Current Ripple | Buck-Boost converter enabled, 50 KHz, 20dB/decade filter on VPOS_IN_x | | 8 | | μ App |
| L | Inductive Load ⁽⁵⁾ | | | | 50 | mH |
| AC-PSRR | AC Power Supply Rejection Ratio | 200 mV 50/60Hz Sine wave superimposed on power supply voltage. | | -75 | | dB |

(4) Vout disabled, no load, ramp rate of VPOS_IN_x, and VNEG_IN_x limited to 18 V/msec

(5) 680 nF is required at IOU_T pin for 50 mH pure inductor load.

7.6 Timing Requirements: Write and Readback Mode

At $T_A = -40^\circ\text{C}$ to $+125^\circ\text{C}$ and $DVDD = +2.7\text{ V}$ to $+5.5\text{ V}$, unless otherwise noted.

| PARAMETER | | TEST CONDITIONS | MIN | MAX | UNIT |
|-------------------|--|-----------------|-----|--|---------------|
| f_{SCLK} | Max clock frequency | | | 25 | MHz |
| t_1 | SCLK cycle time | | 40 | | ns |
| t_2 | SCLK high time | | 18 | | ns |
| t_3 | SCLK low time | | 18 | | ns |
| t_4 | $\overline{\text{SYNC}}$ falling edge to SCLK falling edge setup time | | 15 | | ns |
| t_5 | 24 th /32 nd SCLK falling edge to $\overline{\text{SYNC}}$ rising edge | | 13 | | ns |
| t_6 | $\overline{\text{SYNC}}$ high time | | 40 | | ns |
| t_7 | Data setup time | | 8 | | ns |
| t_8 | Data hold time | | 5 | | ns |
| t_9 | $\overline{\text{SYNC}}$ rising edge to $\overline{\text{LDAC}}$ falling edge | | 33 | | ns |
| t_{10} | $\overline{\text{LDAC}}$ pulse width low | | 10 | | ns |
| t_{11} | $\overline{\text{LDAC}}$ falling edge to DAC output response time | | | 50 | ns |
| t_{12} | DAC output settling time | | | See Electrical Characteristics | μs |
| t_{13} | CLR high time | | 10 | | ns |
| t_{14} | CLR activation time | | | 50 | ns |
| t_{15} | SCLK rising edge to SDO valid | | | 14 | ns |
| t_{16} | $\overline{\text{SYNC}}$ rising edge to DAC output response time | | | 50 | ns |
| t_{17} | $\overline{\text{LDAC}}$ falling edge to $\overline{\text{SYNC}}$ rising edge | | 100 | | ns |
| t_{18} | $\overline{\text{RESET}}$ pulse width | | 10 | | ns |
| t_{19} | $\overline{\text{SYNC}}$ rising edge to CLR falling/rising edge | | 60 | | ns |

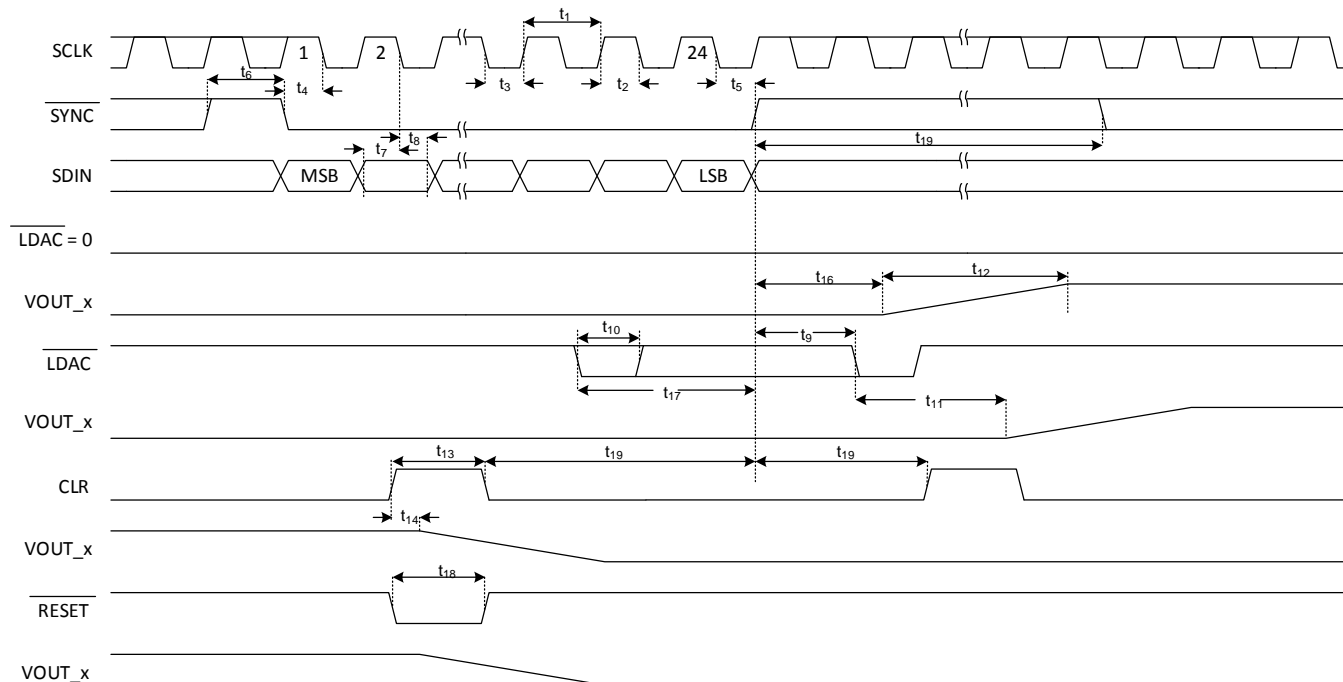

1. Write Mode Timing



图 2. Readback Mode Timing

7.7 Typical Characteristics

AVDD/PVDD_x/VPOS_IN_x = +15 V, VNEG_IN_x = -15 V, PBKG = PVSS_x = 0 V, External DVDD = 5 V, VOUT disabled, IOUT R_L = 250 Ω, T_A = 25°C, REFIN = +5 V external, Buck-Boost Converter disabled, unless otherwise stated.

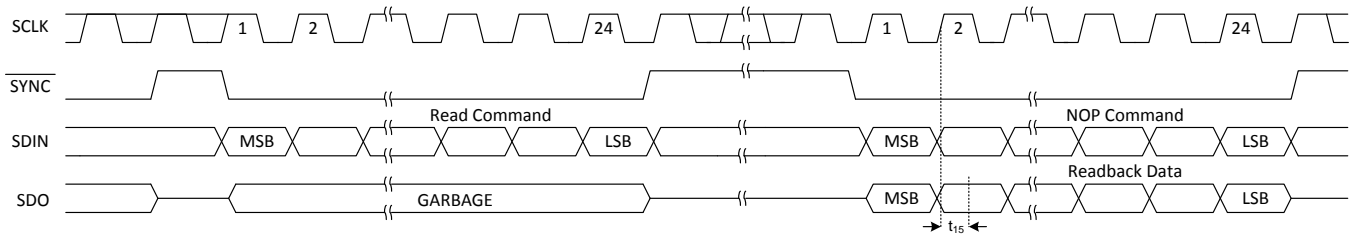

图 3. IOUT Linearity Error vs Digital Input Code



图 4. IOUT Differential Linearity Error vs Digital Input Code

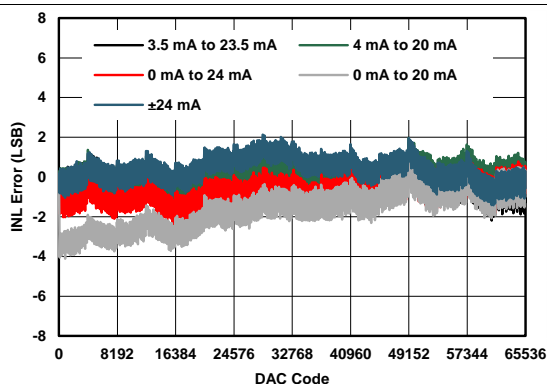

图 5. IOUT Total Unadjusted Error vs Digital Input Code

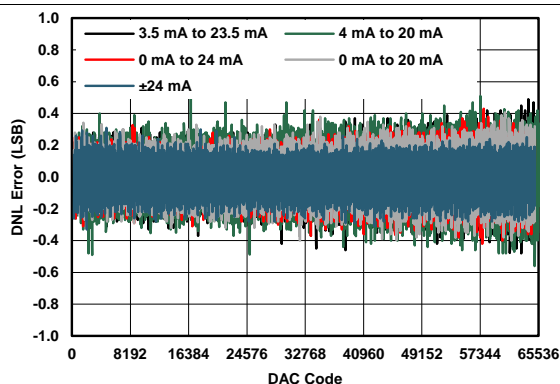

图 6. IOUT Linearity Error vs Temperature

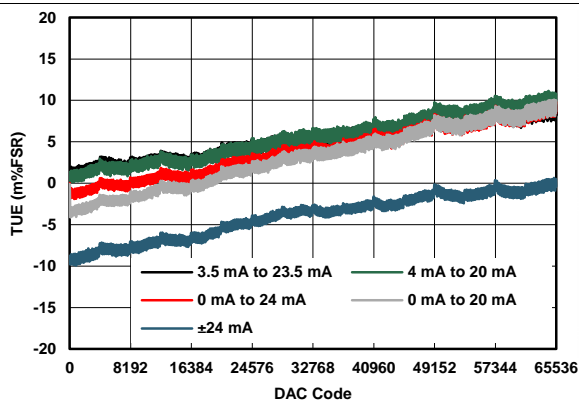

图 7. IOUT Differential Linearity Error vs Temperature

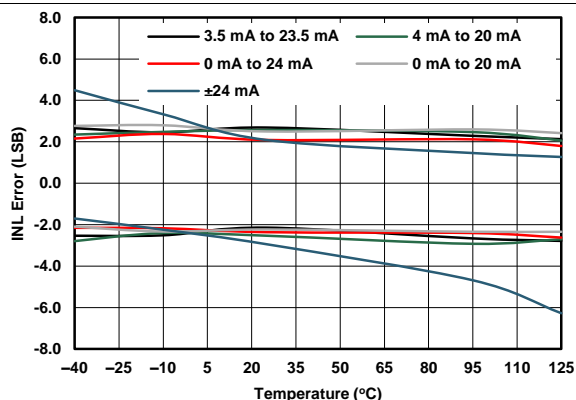

图 8. IOUT Total Unadjusted Error vs Temperature

Typical Characteristics (continued)

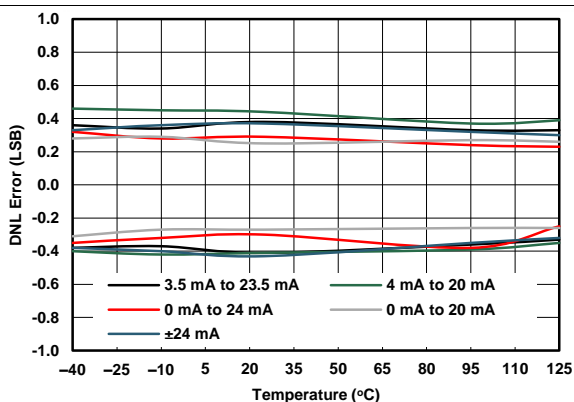
AVDD/PVDD_x/VPOS_IN_x = +15 V, VNEG_IN_x = -15 V, PBKG = PVSS_x = 0 V, External DVDD = 5 V VOUT disabled, IOUT R_L = 250 Ω, T_A = 25°C, REFIN = +5 V external, Buck-Boost Converter disabled, unless otherwise stated.

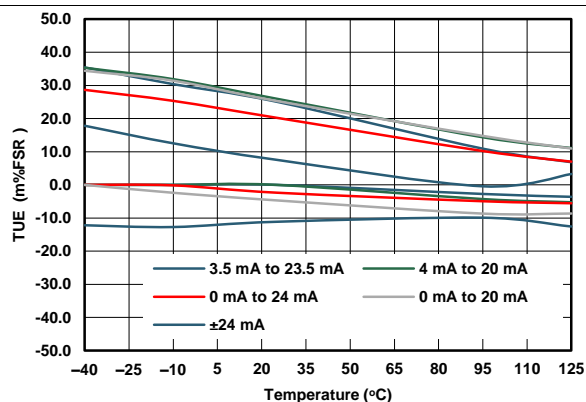
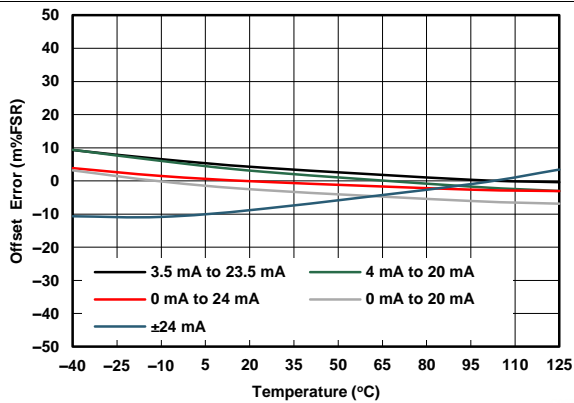

9. IOOUT Offset Error vs Temperature

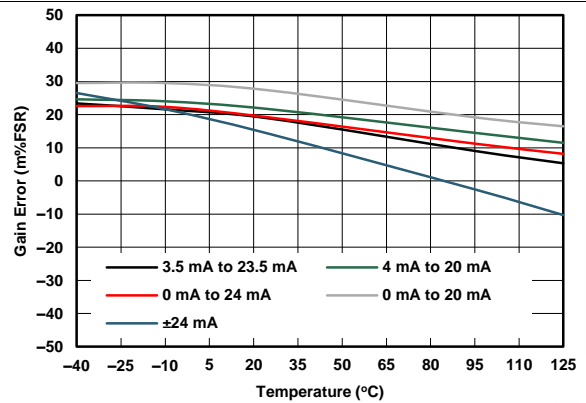

10. IOOUT Gain Error vs Temperature

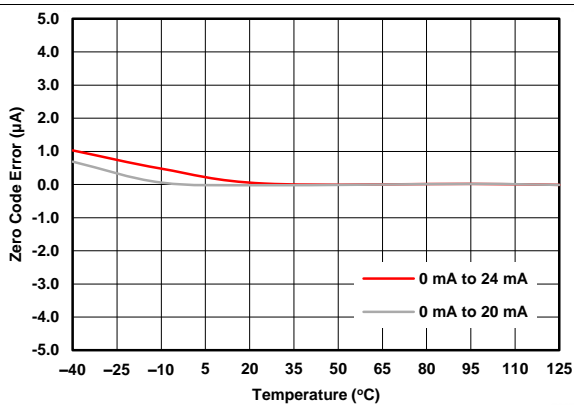

11. IOOUT Zero Code Error vs Temperature

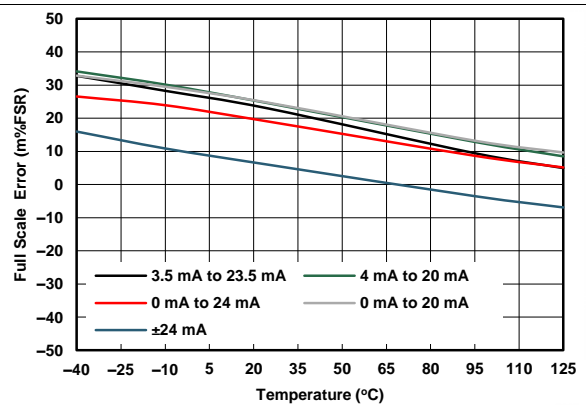

12. IOOUT Full Scale Error vs Temperature

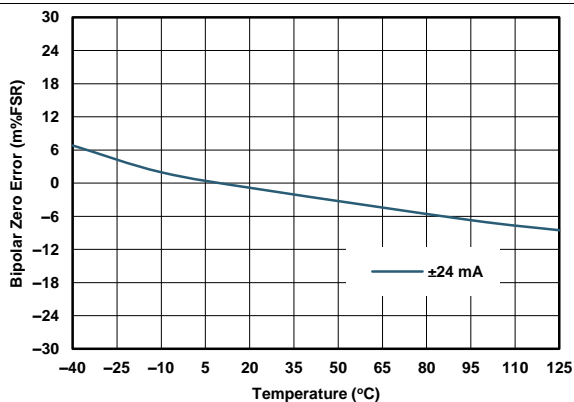

13. IOOUT Bipolar Zero Error vs Temperature

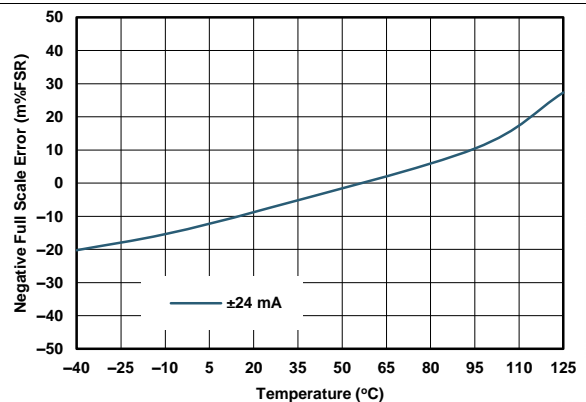

14. IOOUT Negative Full Scale Error vs Temperature

Typical Characteristics (continued)

AVDD/PVDD_x = VPOS_IN_x, VNEG_IN_x = PBKG = PVSS_x = 0 V, External DVDD = 5 V VOUT disabled, IOU_T R_L = 250 Ω, T_A = 25°C, REFIN = +5 V external, Buck-Boost Converter disabled, unless otherwise stated.

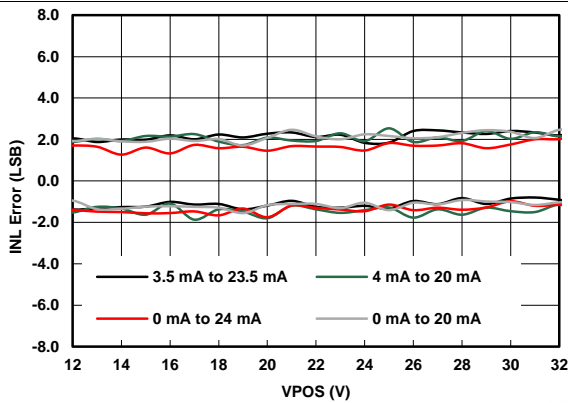

15. IOUT Linearity Error vs Power Supplies

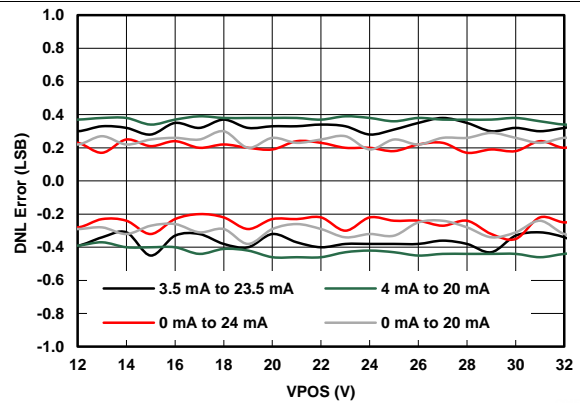

16. IOUT Differential Linearity Error vs Power Supplies

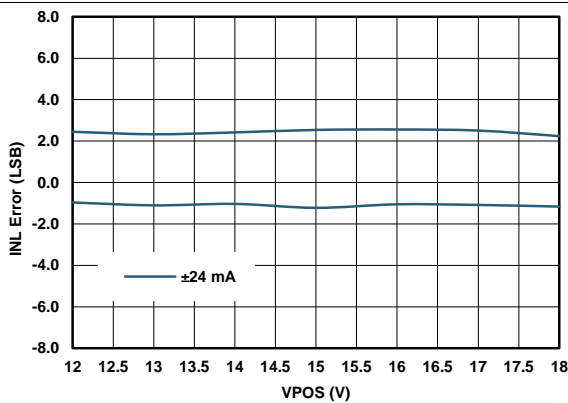

$|VPOS_IN_x| = |VNEG_IN_x|$

17. IOUT Linearity Error vs Power Supplies

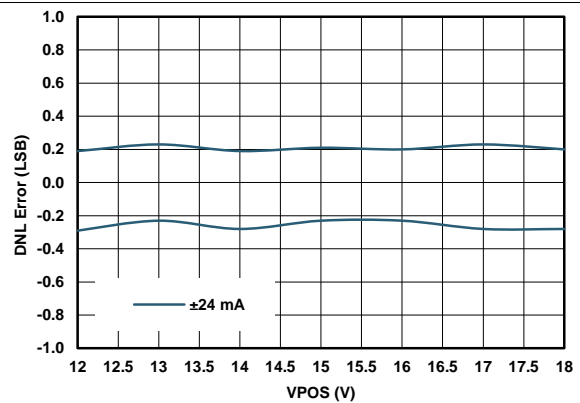

$|VPOS_IN_x| = |VNEG_IN_x|$

18. IOUT Differential Linearity Error vs Power Supplies

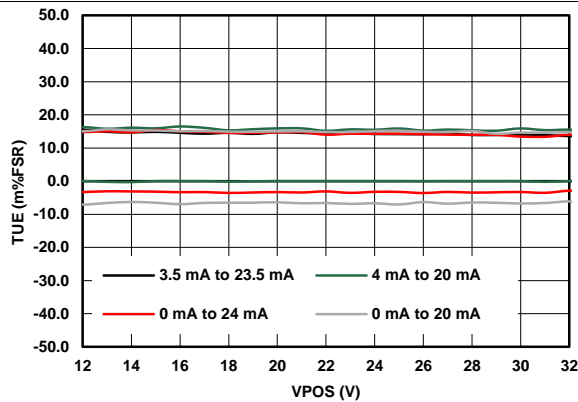

19. IOUT Total Unadjusted Error vs Power Supplies

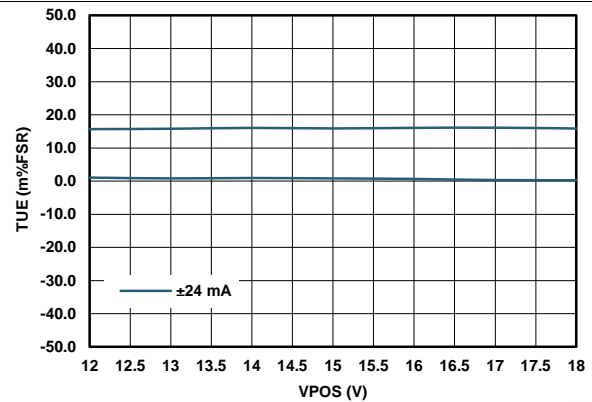

$|VPOS_IN_x| = |VNEG_IN_x|$

20. IOUT Total Unadjusted Error vs Power Supplies

Typical Characteristics (continued)

AVDD/PVDD_x/VPOS_IN_x = +15 V, VNEG_IN_x = -15 V, PBKG = PVSS_x = 0 V, External DVDD = 5 V VOUT disabled, IOUT R_L = 250 Ω, T_A = 25°C, REFIN = +5 V external, Buck-Boost Converter disabled, unless otherwise stated.

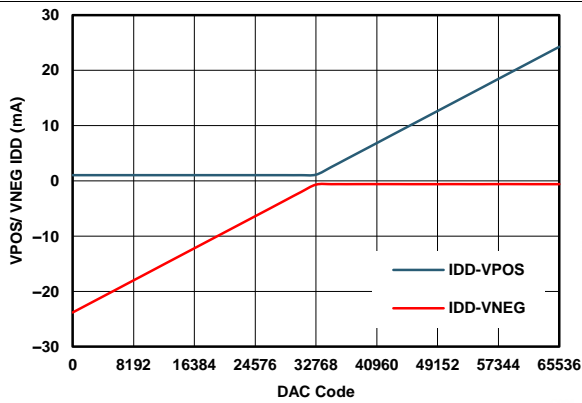

±24 mA Range

☒ 21. IOUT Power Supply Current vs Digital Input Code

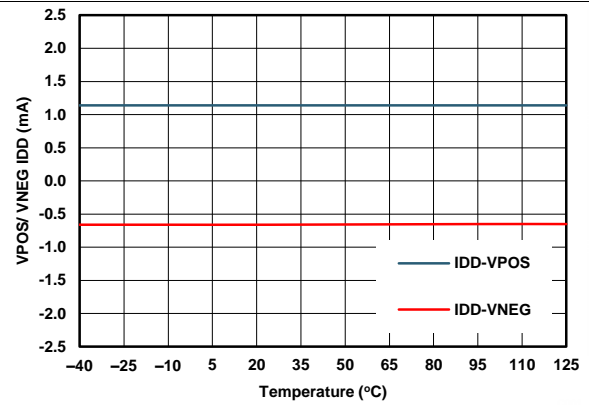

±24 mA Range, Mid Scale Code

☒ 22. IOUT Power Supply Current vs Temperature

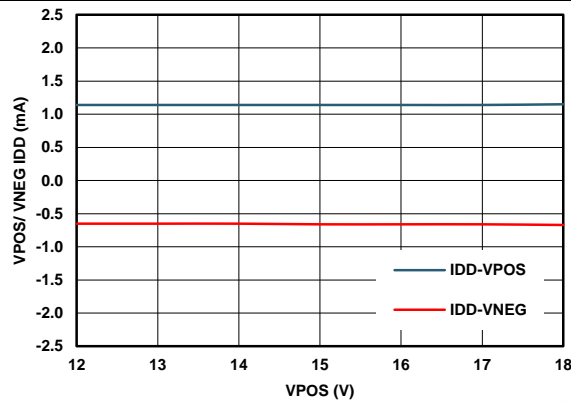

|VPOS_IN_x| = |VNEG_IN_x|, ±24 mA Range, Mid Scale Code

☒ 23. IOUT Power Supply Current vs Power Supplies Voltages

Typical Characteristics (continued)

AVDD/PVDD_x/VPOS_IN_x = +15 V, VNEG_IN_x = -15 V, PBKG = PVSS_x = 0 V, External DVDD = 5 V VOUT disabled, IOUT R_L = 250 Ω, T_A = 25°C, REFIN = +5 V external, Buck-Boost Converter disabled, unless otherwise stated.

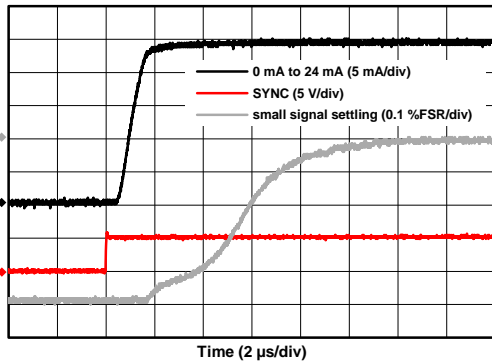

0-24 mA Range

24. IOUT Full-Scale Settling Time, Rising Edge

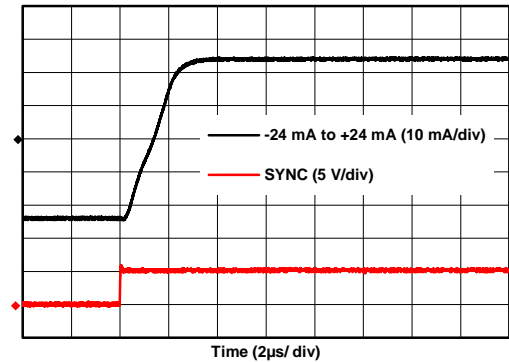

AVDD/PVDD_x/VPOS_IN_x = +18 V, VNEG_IN_x = -18 V, IOUT R_L = 625 Ω

25. IOUT Full-Scale Settling Time, Rising Edge

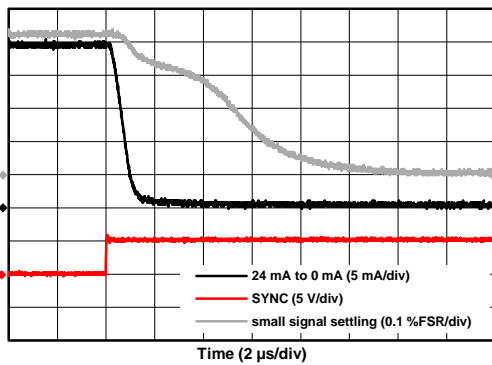

0-24 mA Range

26. IOUT Full-Scale Settling Time, Falling Edge

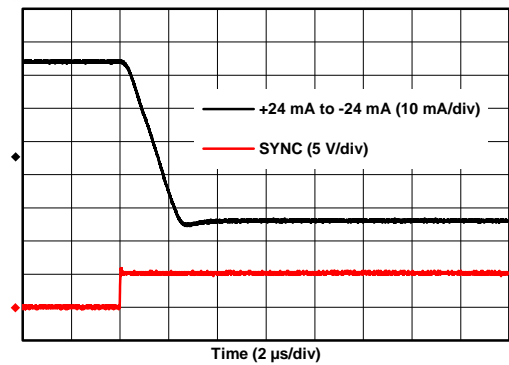

AVDD/PVDD_x/VPOS_IN_x = +18 V, VNEG_IN_x = -18 V, IOUT R_L = 625 Ω

27. IOUT Full-Scale Settling Time, Falling Edge

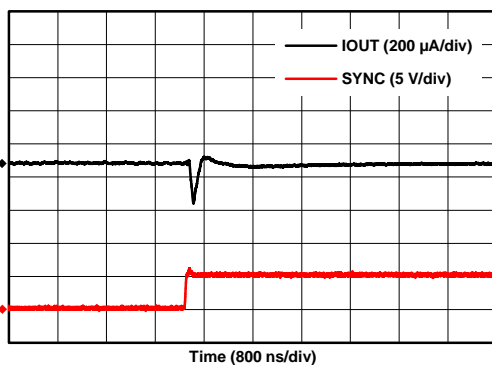

0-24 mA Range, 7FFFh - 8000h

28. IOUT Glitch Impulse, Rising Edge, 1LSB Step

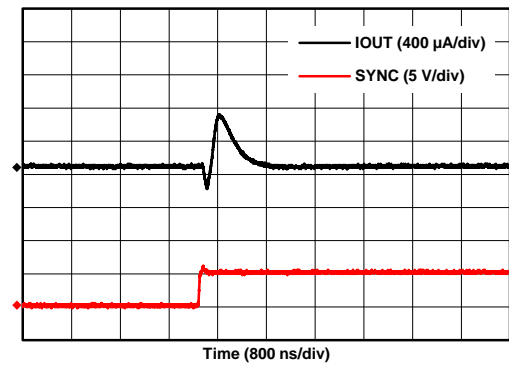

0-24 mA Range, 8000h - 7FFFh

29. IOUT Glitch Impulse, Falling Edge, 1LSB Step

Typical Characteristics (continued)

AVDD/PVDD_x/VPOS_IN_x = +15 V, VNEG_IN_x = -15 V, PBKG = PVSS_x = 0 V, External DVDD = 5 V VOUT disabled, IOUT R_L = 250 Ω, T_A = 25°C, REFIN = +5 V external, Buck-Boost Converter disabled, unless otherwise stated.

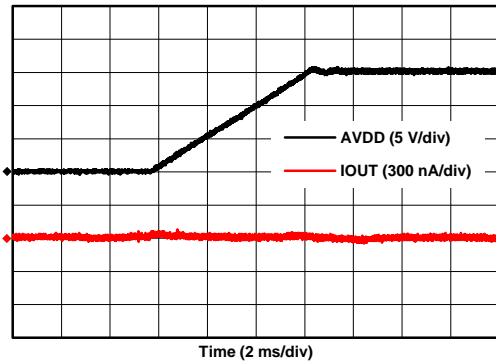
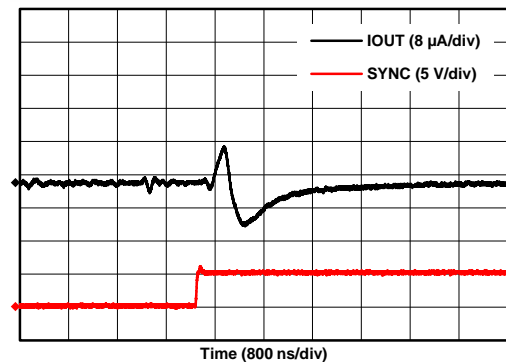
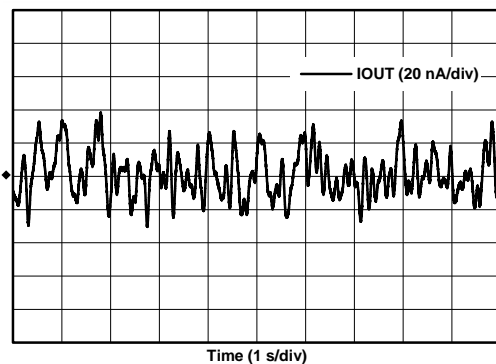

Figure 30. IOUT Power-On Glitch



0-24 mA Range

Figure 31. IOUT Enable Glitch



0-24mA Range, Mid Scale Code

Figure 32. IOUT Noise, 0.1 Hz to 10 Hz

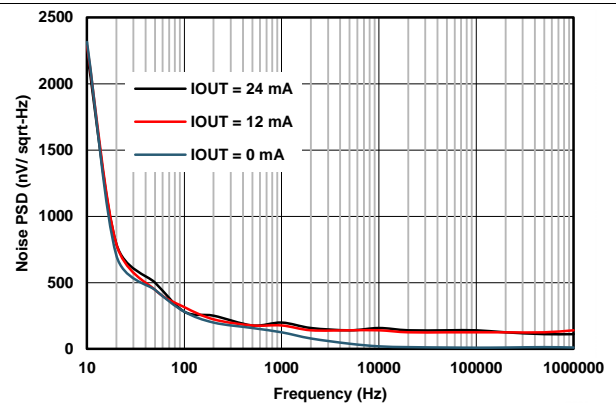

0-24 mA Range

Figure 33. IOUT Noise Density vs Frequency

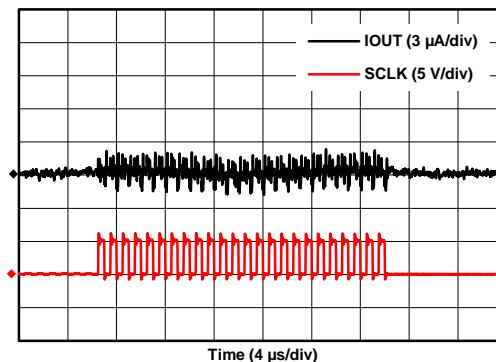

0-24 mA Range, Mid Scale Code, SCLK = 1 MHz

Figure 34. Clock Feedthrough IOUT, 1MHz

Typical Characteristics (continued)

AVDD/PVDD_x = +15 V, PBKG = PVSS_x = 0 V, External DVDD = 5 V, VOUT disabled, IOU_T R_L = 250 Ω, T_A = 25°C, REFIN = +5 V external, Buck-Boost Converter enabled (Full Tracking Mode), unless otherwise stated.

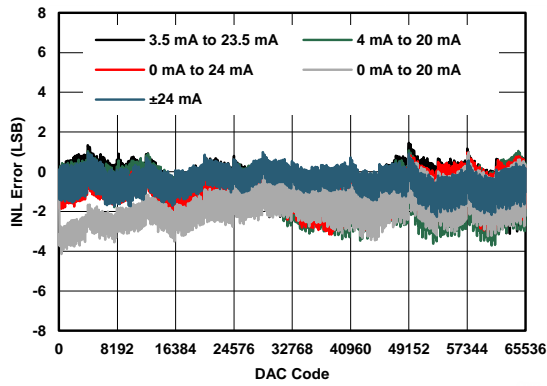

35. IOUT Linearity Error vs Digital Input Code

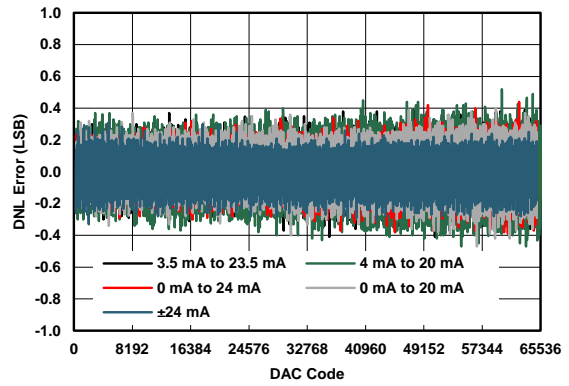

36. IOUT Differential Linearity Error vs Digital Input Code

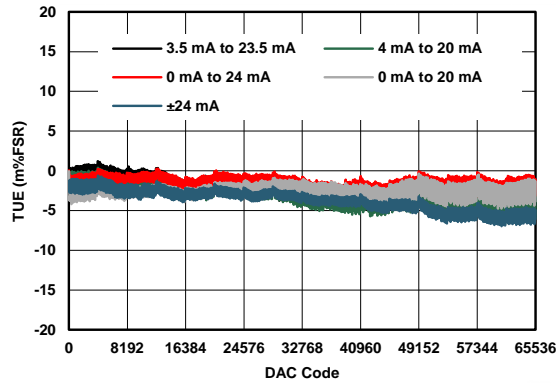

37. IOUT Total Unadjusted Error vs Digital Input Code

Typical Characteristics (continued)

AVDD/PVDD_x = +15 V, PBKG = PVSS_x = 0 V, External DVDD = 5 V, VOUT disabled, IOUT R_L = 250 Ω, T_A = 25°C, REFIN = +5 V external, Buck-Boost Converter enabled (Full Tracking Mode), unless otherwise stated.

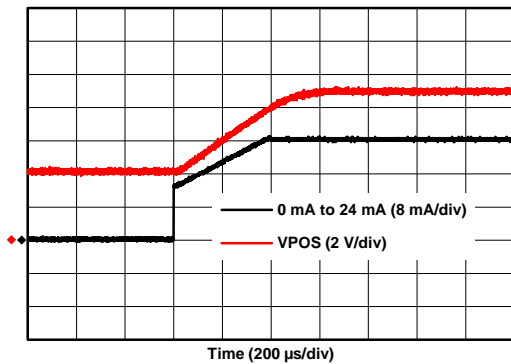

0-24 mA Range

⊗ 38. IOUT Full-Scale Settling Time, Rising Edge

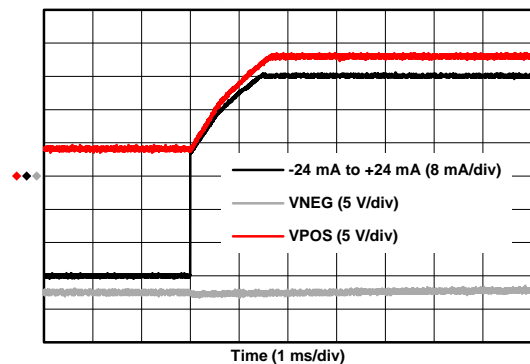

IOUT R_L = 625 Ω

⊗ 39. IOUT Full-Scale Settling Time, Rising Edge

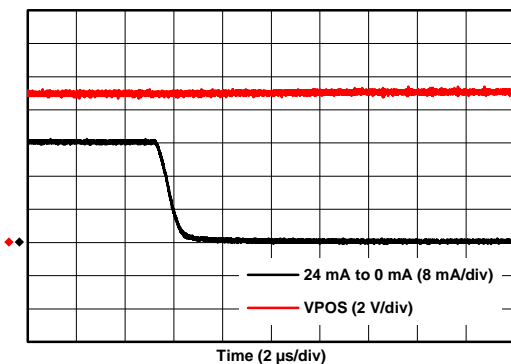

0-24 mA Range

⊗ 40. IOUT Full-Scale Settling Time, Falling Edge

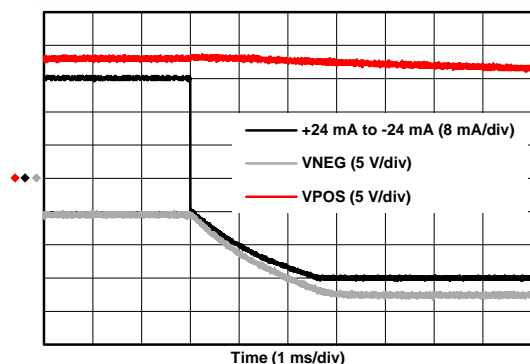

IOUT R_L = 625 Ω

⊗ 41. IOUT Full-Scale Settling Time, Falling Edge

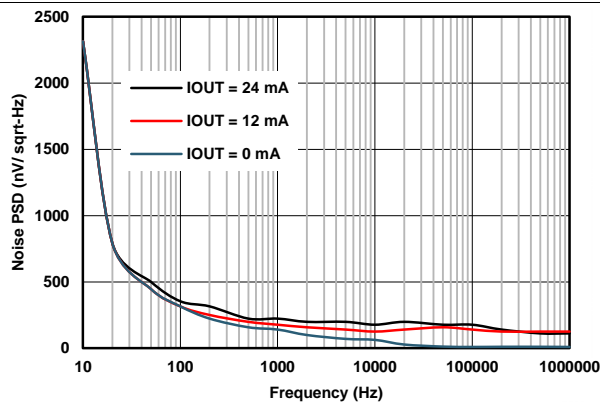

0-24 mA Range

⊗ 42. IOUT Noise Density vs Frequency

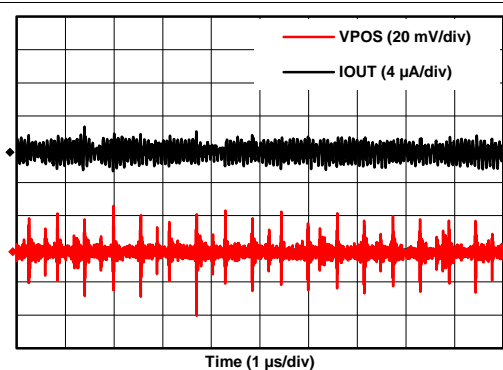

0-24 mA Range, Mid Scale Code

⊗ 43. IOUT Ripple

Typical Characteristics (continued)

AVDD/PVDD_x/VPOS_IN_x = +15 V, VNEG_IN_x = -15 V, VSENSE_x = PBKG = PVSS_x = 0 V, External DVDD = 5 V. VOUT No load, IOUT disabled; T_A = 25°C, REFIN = +5 V external; Buck-Boost Converter disabled unless otherwise stated.

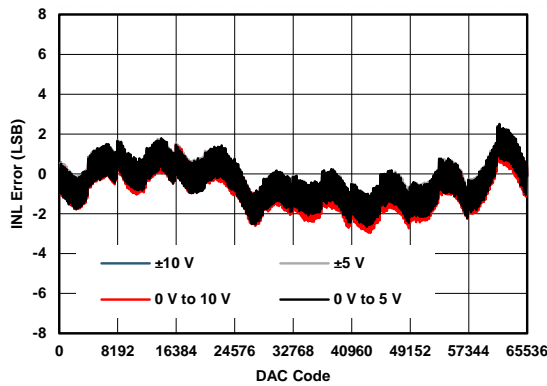

Figure 44. VOUT Linearity Error vs Digital Input Code

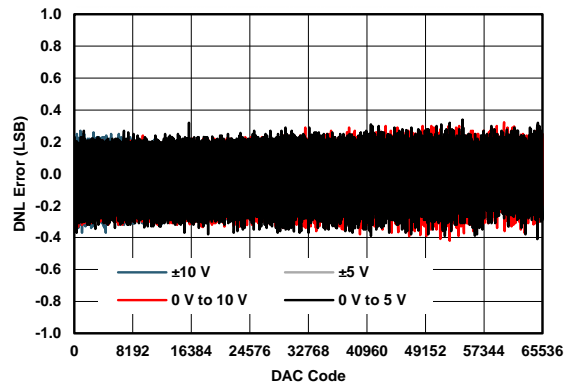

Figure 45. VOUT Differential Linearity Error vs Digital Input Code

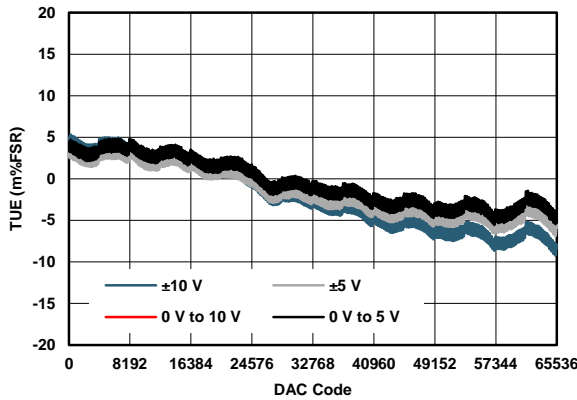

Figure 46. VOUT Total Unadjusted Error vs Digital Input Code

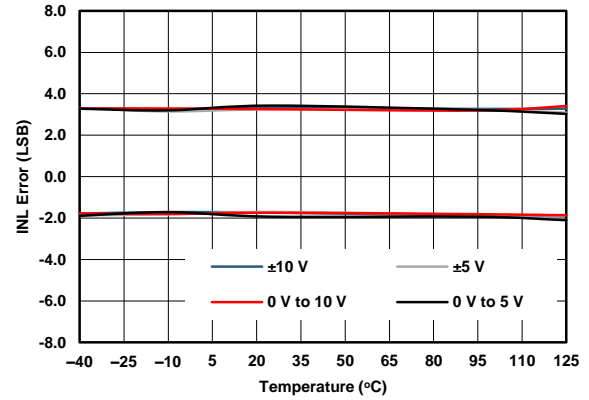

Figure 47. VOUT Linearity Error vs Temperature

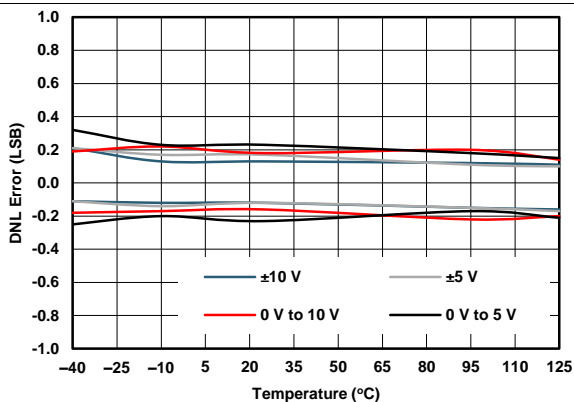

Figure 48. VOUT Differential Linearity Error vs Temperature

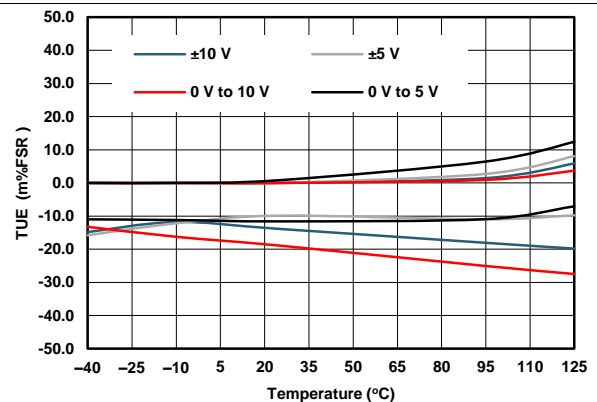
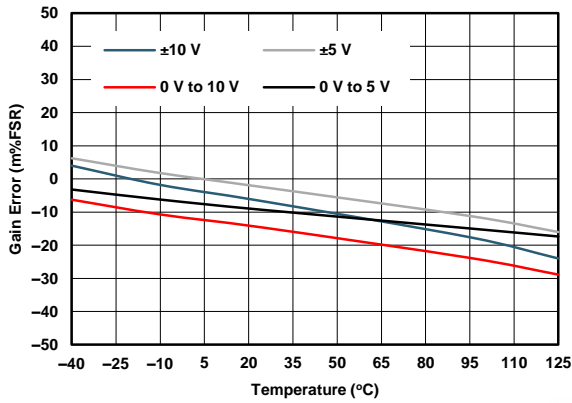

Figure 49. VOUT Total Unadjusted Error vs Temperature

Typical Characteristics (continued)

AVDD/PVDD_x/VPOS_IN_x = +15 V, VNEG_IN_x = -15 V, VSENSE_x = PBKG = PVSS_x = 0 V, External DVDD = 5 V.
 VOUT No load, IOUT disabled; T_A = 25°C, REFIN = +5 V external; Buck-Boost Converter disabled unless otherwise stated.



50. VOUT Gain Error vs Temperature

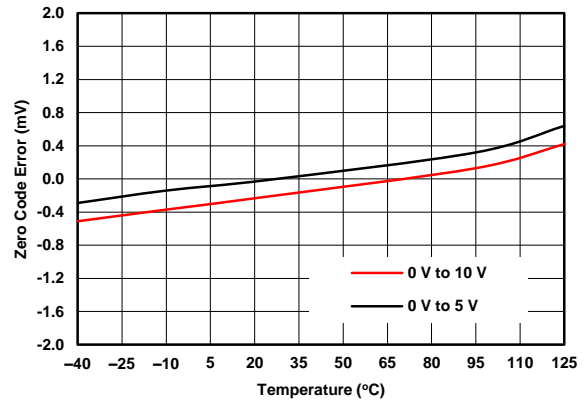

51. VOUT Zero Code Error vs Temperature

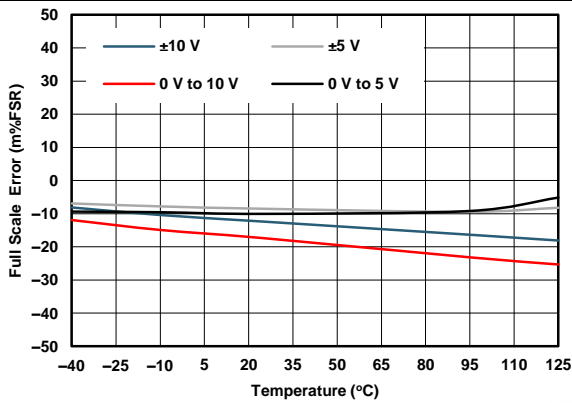

52. VOUT Full Scale Error vs Temperature

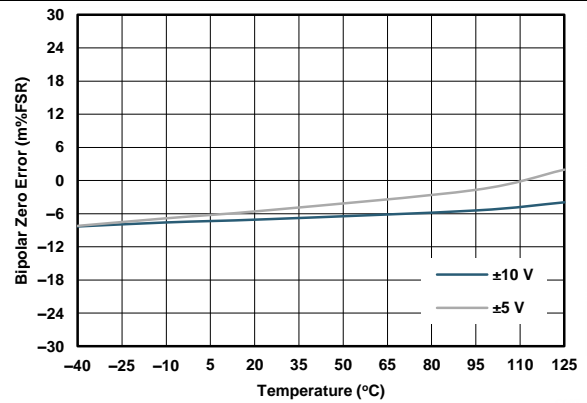

53. VOUT Bipolar Zero Error vs Temperature

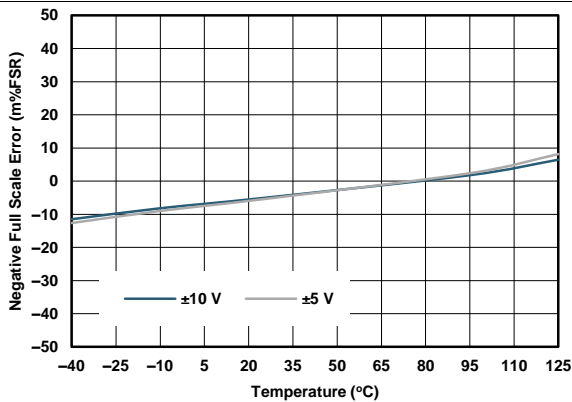

54. VOUT Negative Full Scale Error vs Temperature

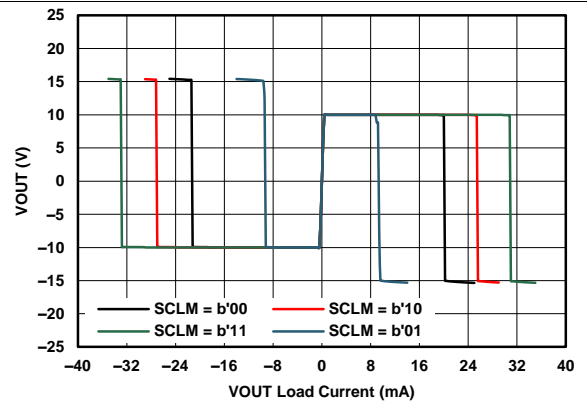

±10-V Range, Full Scale Code for VOUT sourcing & Zero Scale Code for VOUT Sinking

55. VOUT Output Voltage vs Load Current

Typical Characteristics (continued)

AVDD/PVDD_x/VPOS_IN_x = +15 V, VNEG_IN_x = -15 V, VSENSE_x = PBKG = PVSS_x = 0 V, External DVDD = 5 V. VOUT No load, IOUT disabled; T_A = 25°C, REFIN = +5 V external; Buck-Boost Converter disabled unless otherwise stated.

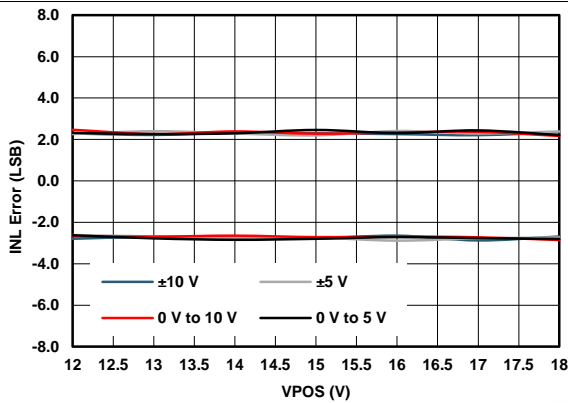

|VPOS_IN_x| = VNEG_IN_x

56. VOUT Linearity Error vs Power Supplies

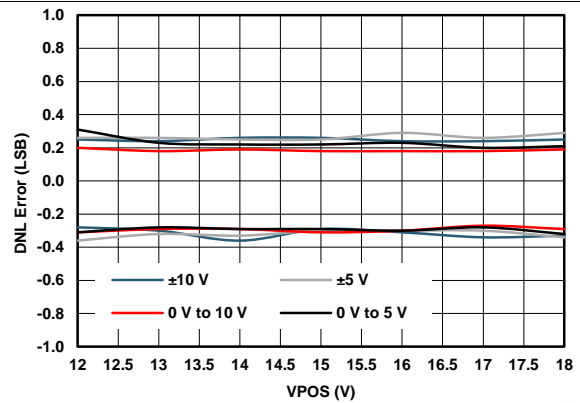

|VPOS_IN_x| = VNEG_IN_x

57. VOUT Differential Linearity Error vs Power Supplies

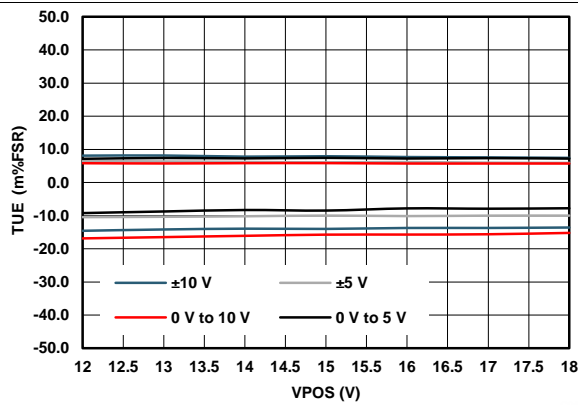

|VPOS_IN_x| = VNEG_IN_x

58. VOUT Total Unadjusted Error vs Power Supplies

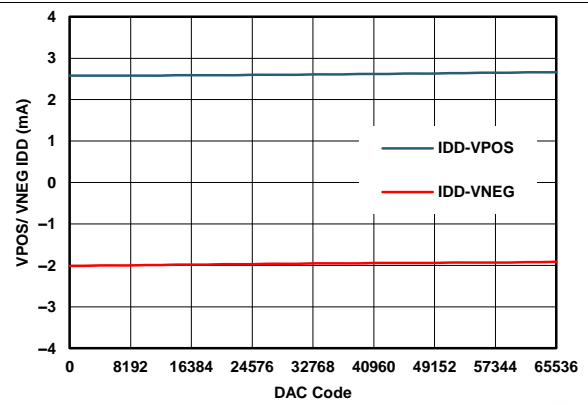

|VPOS_IN_x| = VNEG_IN_x, 10-V Range

59. VOUT Power Supply Current vs Digital Input Code

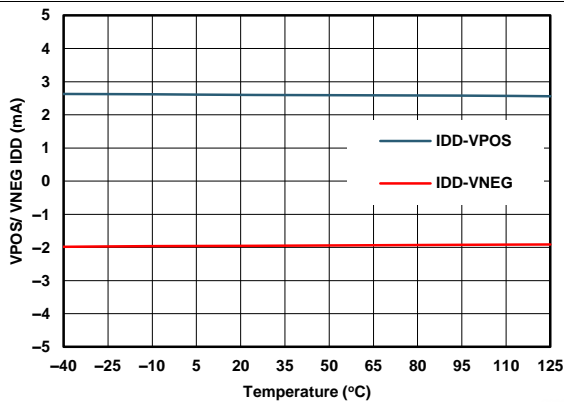

|VPOS_IN_x| = VNEG_IN_x, 10-V Range, Mid Scale Code

60. VOUT Power Supply Current vs Temperature

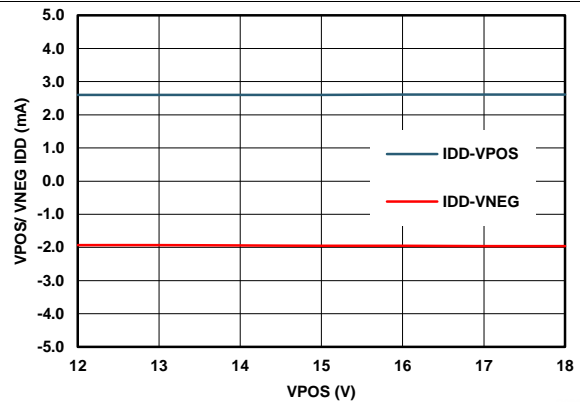

|VPOS_IN_x| = VNEG_IN_x, 10-V Range, Mid Scale Code

61. VOUT Power Supply Current vs Power Supplies Voltages

Typical Characteristics (continued)

AVDD/PVDD_x/VPOS_IN_x = +15 V, VNEG_IN_x = -15 V, VSENSE_x = PBKG = PVSS_x = 0 V, External DVDD = 5 V. VOUT No load, IOUT disabled; T_A = 25°C, REFIN = +5 V external; Buck-Boost Converter disabled unless otherwise stated.

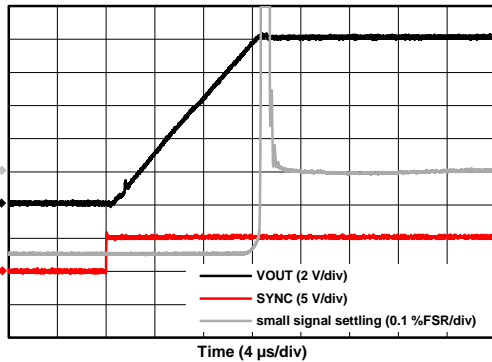

10-V Range, Load 1K//200pF

Figure 62. VOUT Full-Scale Settling Time, Rising Edge

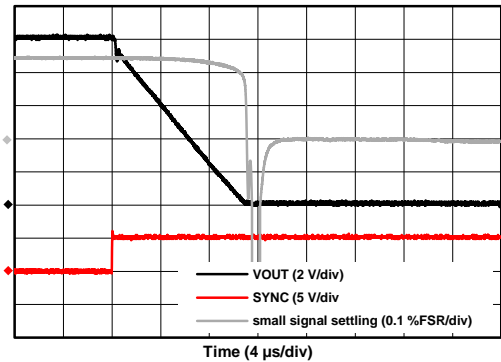

10-V Range, Load 1K//200pF

Figure 63. VOUT Full-Scale Settling Time, Falling Edge

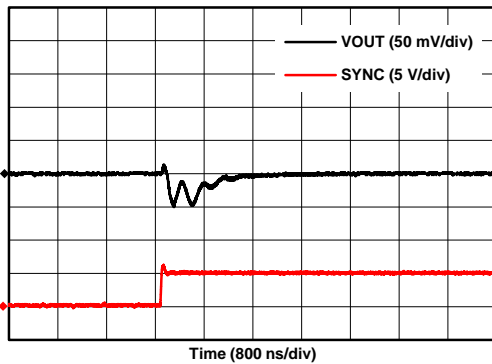

10-V Range, 7FFFh - 8000h

Figure 64. VOUT Glitch Impulse, Rising Edge, 1LSB Step

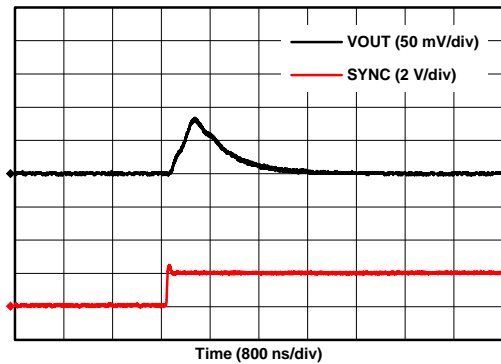

10-V Range, 8000h - 7FFFh

Figure 65. VOUT Glitch Impulse, Falling Edge, 1LSB Step

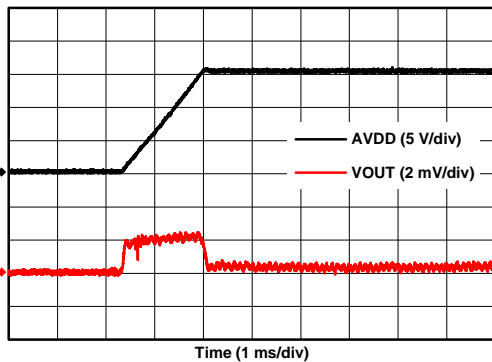
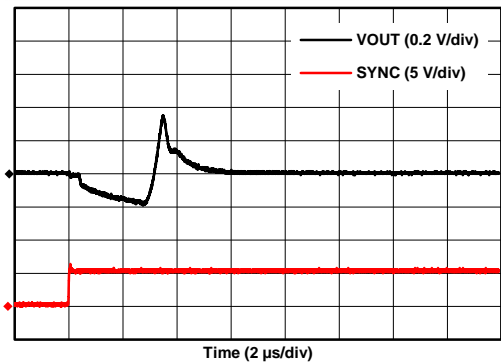

Figure 66. VOUT Power-On Glitch



10V Range

Figure 67. VOUT Enable Glitch

Typical Characteristics (continued)

AVDD/PVDD_x/VPOS_IN_x = +15 V, VNEG_IN_x = -15 V, VSENSE_x = PBKG = PVSS_x = 0 V, External DVDD = 5 V.
VOUT No load, IOUT disabled; T_A = 25°C, REFIN = +5 V external; Buck-Boost Converter disabled unless otherwise stated.

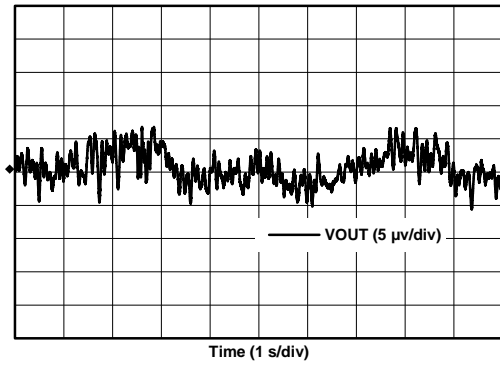

10-V Range, Mid Scale Code

⊠ 68. VOUT Noise, 0.1 Hz to 10 Hz

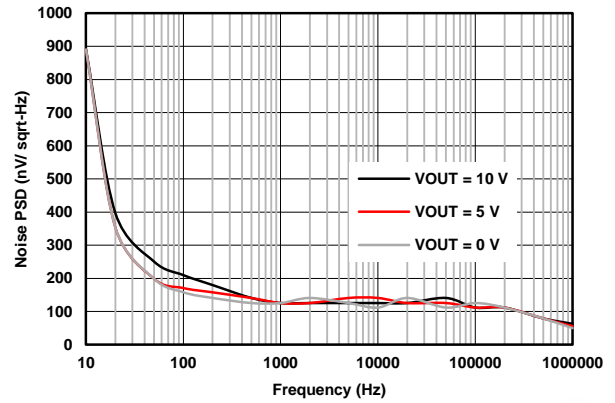

10-V Range

⊠ 69. VOUT Noise Density vs Frequency

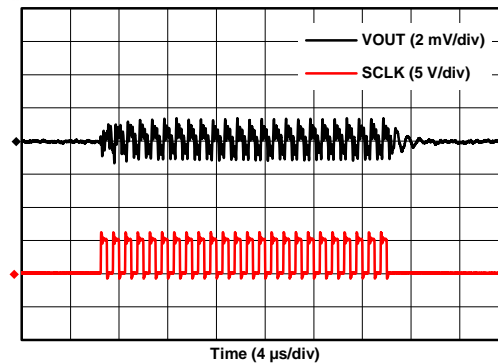

10-V Range, Mid Scale Code, SCLK = 1MHz

⊠ 70. Clock Feedthrough VOUT, 1MHz

Typical Characteristics (continued)

AVDD/PVDD_x = +15 V, VSENSEN_x = PBKG = PVSS_x = 0 V, External DVDD = 5 V. VOUT No load, IOOUT disabled; T_A = 25°C, REFIN = +5 V external; Buck-Boost Converter enabled (Full Tracking Mode), unless otherwise stated.

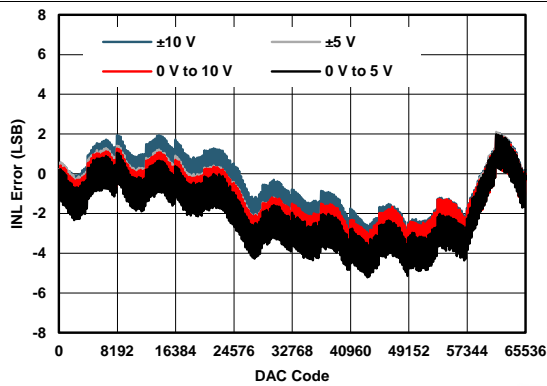

71. VOUT Linearity Error vs Digital Input Code

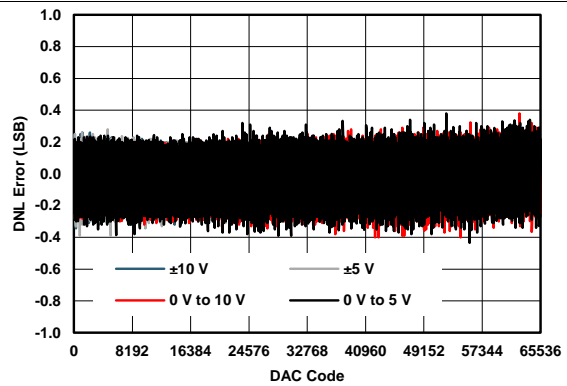

72. VOUT Differential Linearity Error vs Digital Input Code

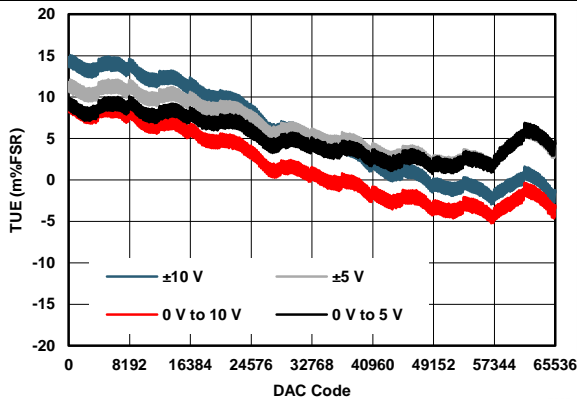

73. VOUT Total Unadjusted Error vs Digital Input Code

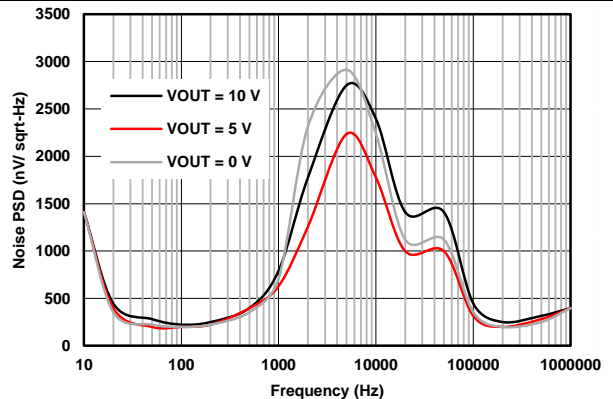

10-V Range

74. VOUT Noise Density vs Frequency

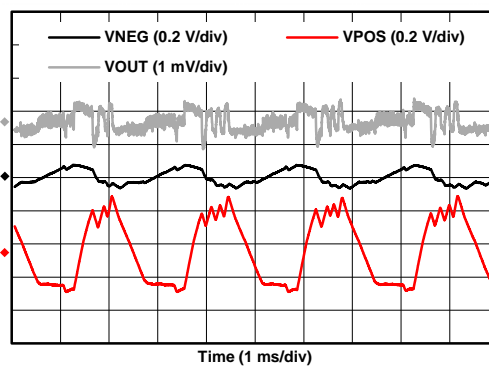

10-V Range, Mid Scale Code

75. VOUT Ripple

Typical Characteristics (continued)

AVDD/PVDD_x/VPOS_IN_x = +15 V, VNEG_IN_x = -15 V, PBKG = PVSS_x = 0 V, External DVDD = 5 V. VOUT disabled, IOUT disabled, T_A = 25°C, Buck-Boost Converter disabled, unless otherwise stated.

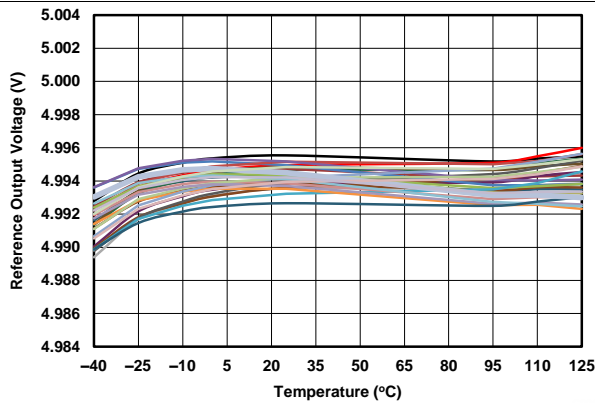

30 Units

76. Internal Reference Voltage vs Temperature

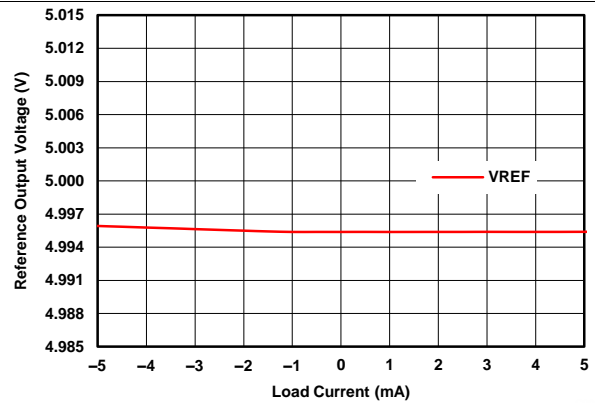

77. Internal Reference Voltage vs Load Current

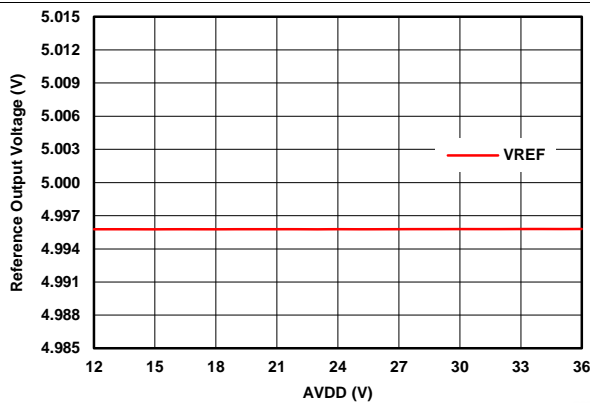

78. Internal Reference Voltage vs Power Supply

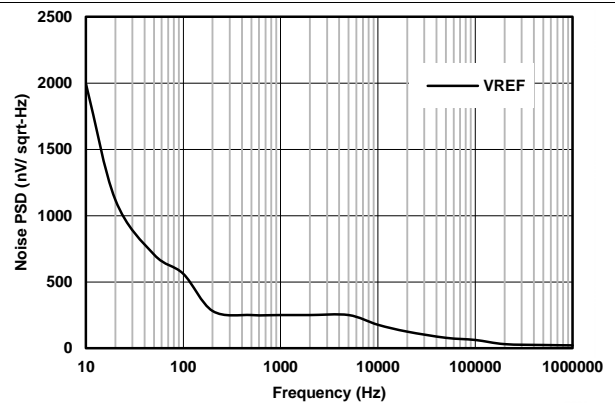

79. Internal Reference Noise Density vs Frequency

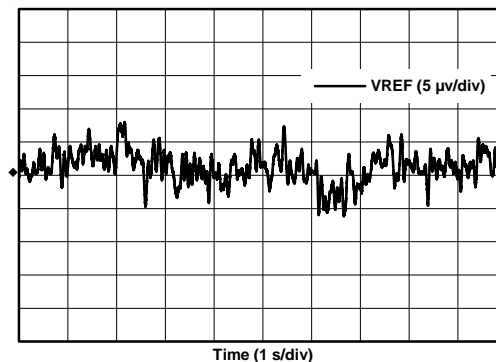

80. Internal Reference Noise, 0.1 Hz to 10 Hz

Typical Characteristics (continued)

AVDD/PVDD_x = +15 V, PBKG = PVSS_x = 0 V, External DVDD = 5 V, VOUT disabled, IOUT R_L = 250Ω, T_A = 25°C, Buck-Boost Converter enabled (Full Tracking Mode), unless otherwise stated.

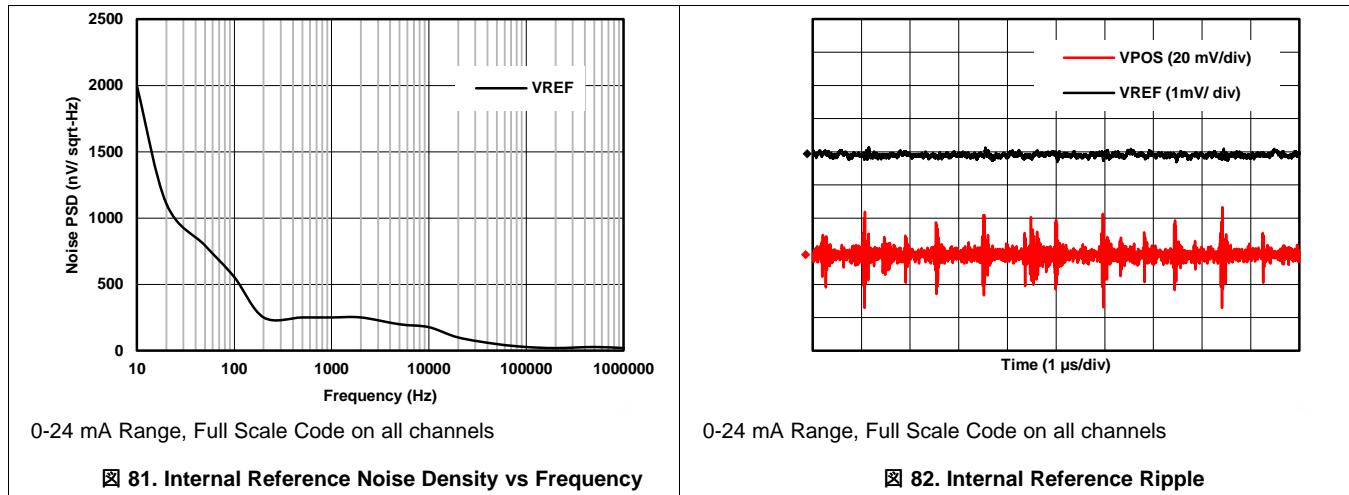

Typical Characteristics (continued)

AVDD/PVDD_x = +15 V, PBKG = PVSS_x = 0 V, External DVDD = 5 V, T_A = 25°C, Buck-Boost Converter enabled (Full Tracking Mode), unless otherwise stated.

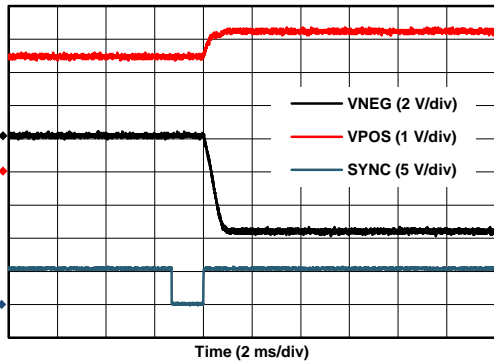

83. Buck-Boost Converter Power-On (IOUT Mode)

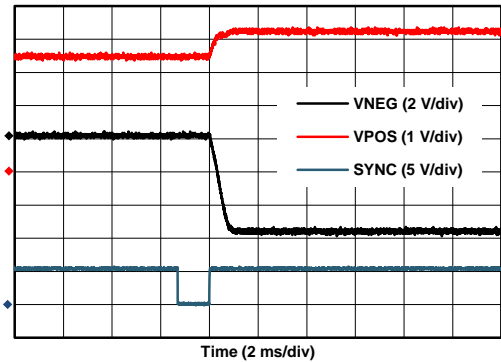

84. Buck-Boost Converter Power-On (VOUT Mode)

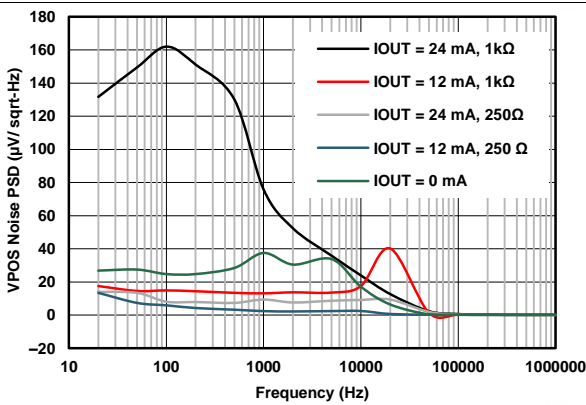

0-24 mA Range, R_L = 250 Ω

85. VPOS Noise Density (IOUT Mode) vs Frequency

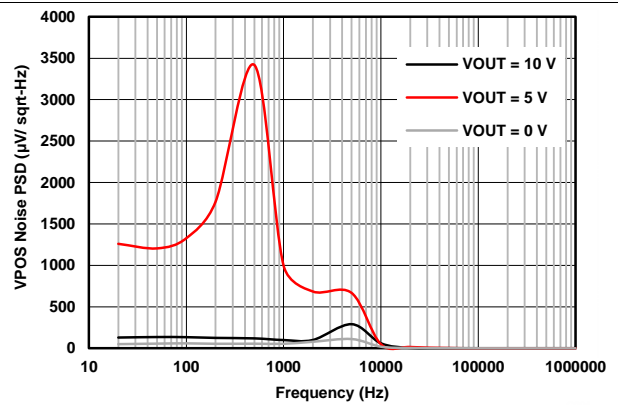

10-V Range, No Load

86. VPOS Noise Density (VOUT Mode) vs Frequency

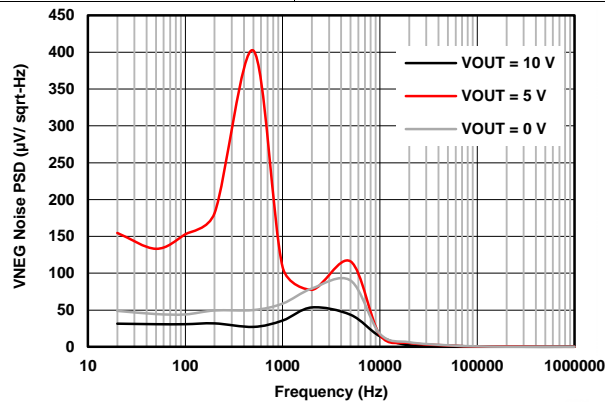

10-V Range, No Load

87. VNEG Noise Density (VOUT Mode) vs Frequency

Typical Characteristics (continued)

AVDD/PVDD_x = +15 V, VNEG_IN_x = PBKG = PVSS_x = 0 V, External DVDD = 5 V, VOUT disabled, IOOUT enabled 0-24 mA Range, T_A = 25°C, REFIN = +5 V external, Buck-Boost Converter VPOS_IN_x enabled (Full Tracking Mode), unless otherwise stated.

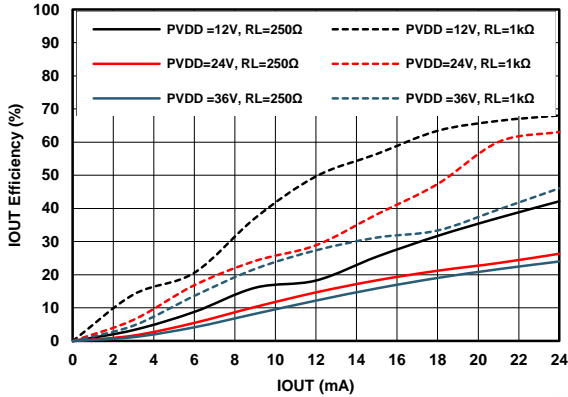

88. IOOUT Efficiency vs Load Current

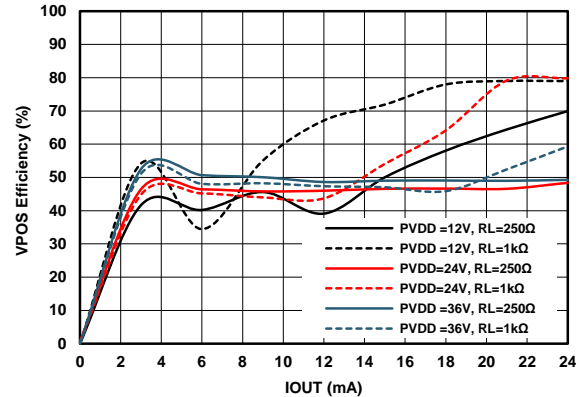

89. VPOS Efficiency (IOOUT Mode) vs Load Current

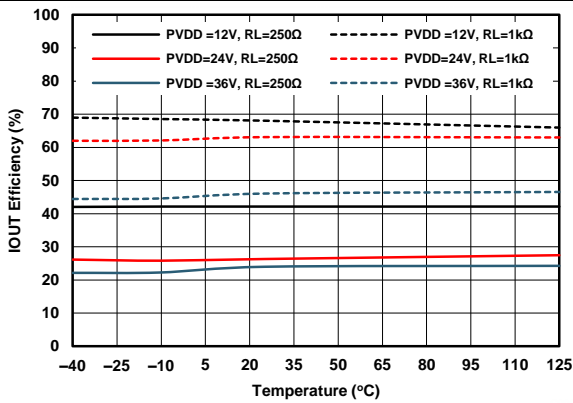

Full Scale Code IOOUT = 24 mA

90. IOOUT Efficiency vs Temperature

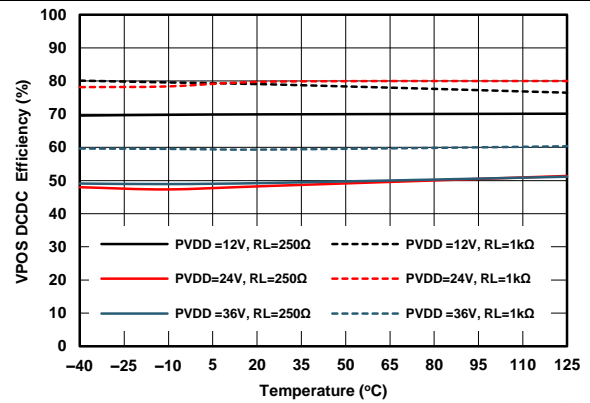

Full Scale Code IOOUT = 24 mA

91. VPOS Efficiency (IOOUT Mode) vs Temperature

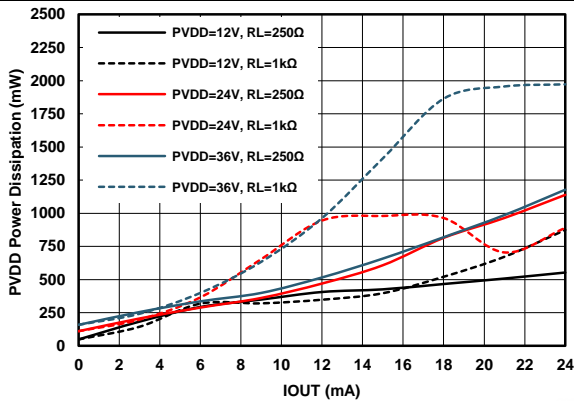

Full Scale Code IOOUT = 24 mA

92. PVDD Power Loss (IOOUT Mode) vs Load Current

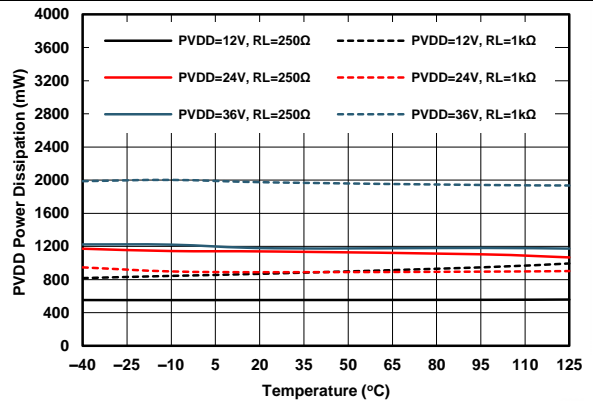

Full Scale Code, 24 mA on all channels

93. PVDD Power Loss (IOOUT Mode) vs Temperature

Typical Characteristics (continued)

AVDD/PVDD_x = +15 V, PBKG = PVSS_x = 0 V, External DVDD = 5 V, VOUT enabled, 10-V Range, Load 1K//200pF, IOUT disabled, T_A = 25°C, REFIN = +5 V external, Buck-Boost Converter enabled (Full Tracking Mode), unless otherwise stated.

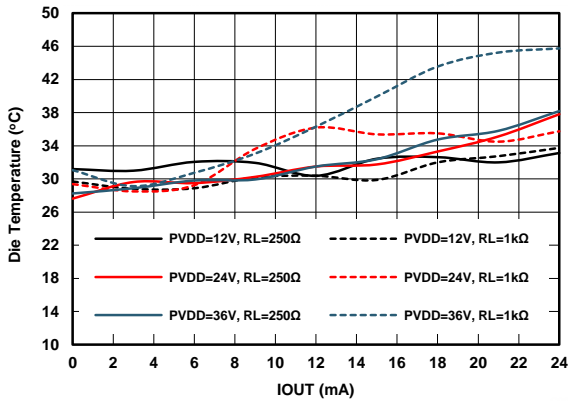

VOUT disabled, IOUT = 24 mA (all channels), VNEG_IN_x = 0 V

94. Internal Die Temperature (IOUT Mode) vs Load Current

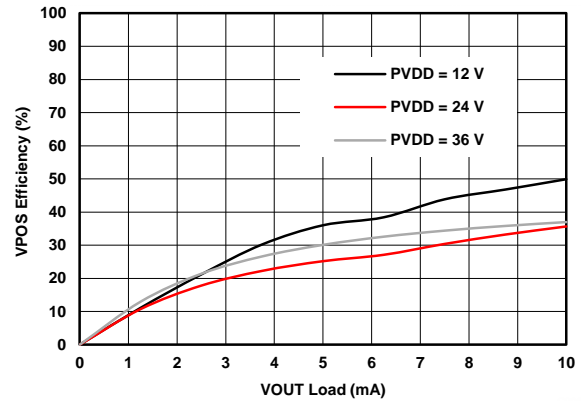

95. VPOS Efficiency (VOUT Mode) vs Load Current

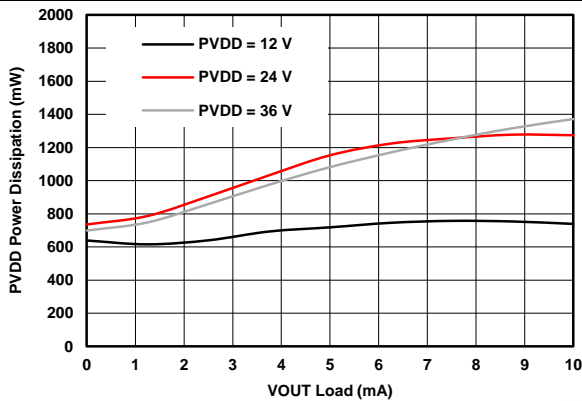

Full Scale Code on all channels

96. PVDD Power Loss (VOUT Mode) vs Load Current

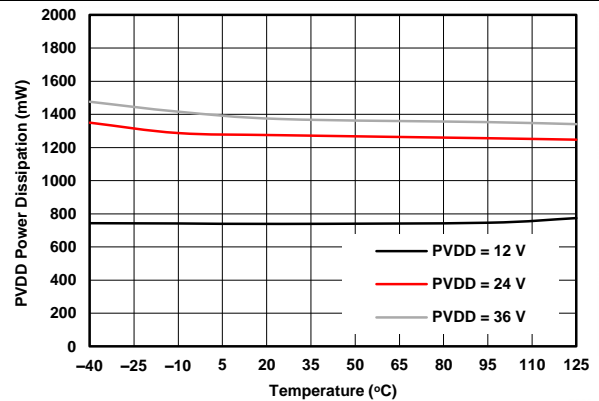

Full Scale Code on all channels

97. PVDD Power Loss (VOUT Mode) vs Temperature

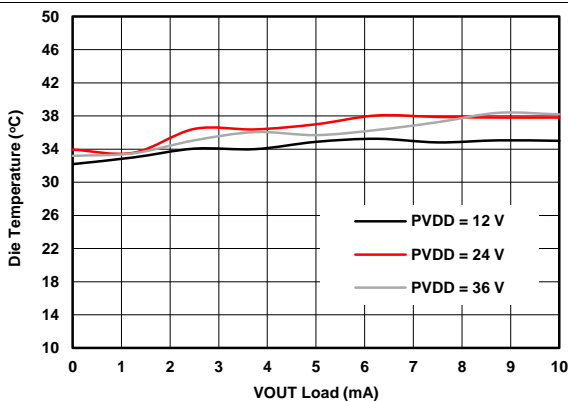

All channels enabled

98. Internal Die Temperature (VOUT Mode) vs Load Current

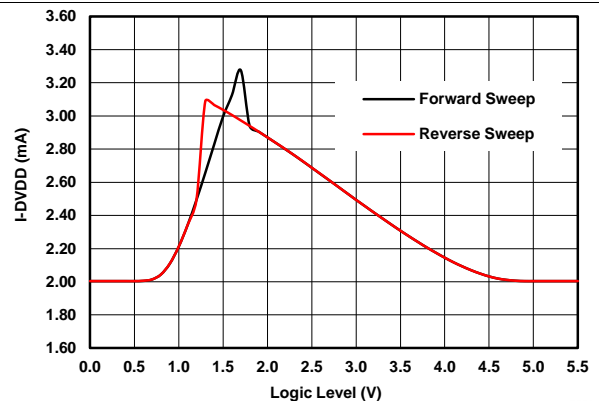

99. Power Supply Current (DVDD) vs Input Logic Level

8 Detailed Description

8.1 Overview

Each channel of DAC8775 consists of a resistor-string digital-to-analog converter (DAC) followed by buffer amplifiers. The output of the buffer drives the current output stage and the voltage output amplifier. The resistor-string section is simply a string of resistors, each of value R, from REFIN to PBKG, as the [Functional Block Diagram](#) illustrates. This type of architecture ensures DAC monotonicity. The 16-bit binary digital code loaded to the DAC register determines at which node on the string the voltage is tapped off before being fed into the output amplifier. The current output stage converts the output from the string to current using a precision current source. The voltage output provides a voltage output to the external load. When the current output stage or the voltage output stage is disabled, the respective output pin is in Hi-Z state. After power-on, both output stages are disabled. Each channel of DAC8775 also contains a Buck-Boost converter which can be used to generate the power supply for the current output stage and voltage output amplifier.

8.2 Functional Block Diagram

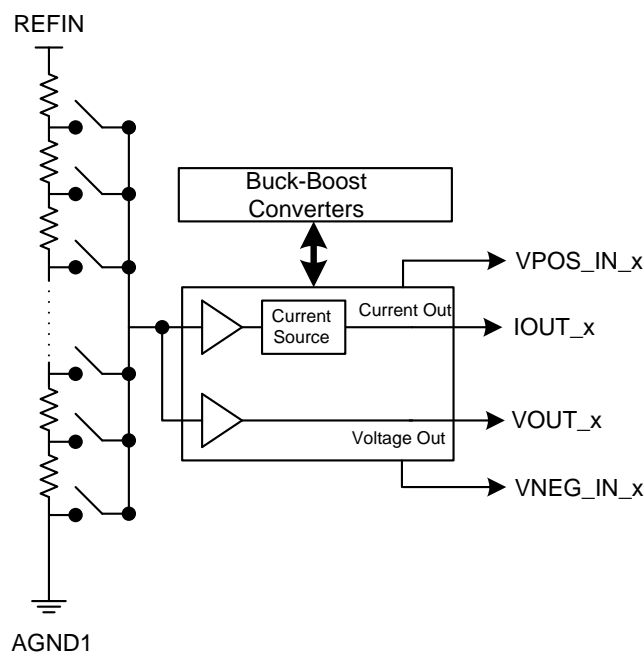

Copyright © 2016, Texas Instruments Incorporated

ⓧ 100. General Architecture

8.3 Feature Description

8.3.1 Current Output Stage

Each channel's current output stage consists of a pre-conditioner and a precision current source as shown in [ⓧ 101](#). This stage provides a current output according to the DAC code. The output range can be programmed as 0 mA to 20 mA, 0 mA to 24 mA, 4 mA to 20 mA, 3.5 mA to 23.5 mA, or ± 24 mA. In the current output mode, the maximum compliance voltage on pin IOOUT_x is between $(-|VNEG_IN_x| + 3\text{ V}) \leq |IOOUT_x| \leq (VPOS_IN_x - 3\text{ V})$. This compliance voltage is automatically maintained when the Buck-Boost converter is used to generate these supplies (see [Buck-Boost Converter](#) section). However, when using an external supply for VPOS_IN_x pin (Buck-Boost converter disabled), the VPOS_IN_x and VNEG_IN_x supplies should be chosen such that this compliance voltage is maintained.

Feature Description (continued)

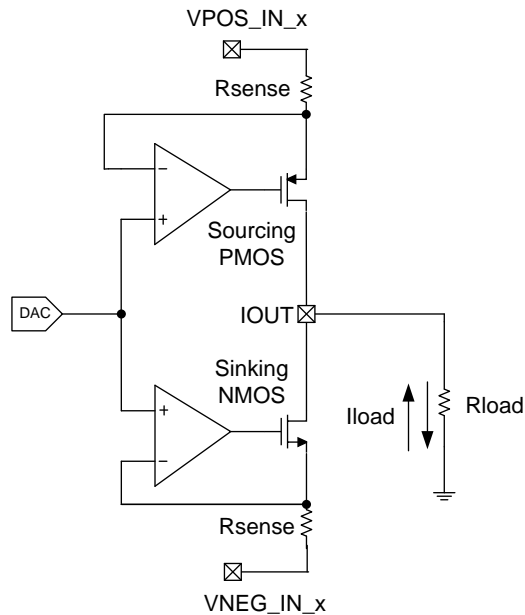

Copyright © 2016, Texas Instruments Incorporated

图 101. Current Output

The 16 bit data can be written to DAC8775 using address 0x05 (DAC data registers, see [表 5](#) and [表 6](#)).

For a 0-mA to 20-mA output range:

$$IOUT_x = 20 \text{ mA} \cdot \left[\frac{CODE}{2^N} \right] \quad (1)$$

For a 0-mA to 24-mA output range:

$$IOUT_x = 24 \text{ mA} \cdot \left[\frac{CODE}{2^N} \right] \quad (2)$$

For a 3.5-mA to 23.5-mA output range:

$$IOUT_x = 20 \text{ mA} \cdot \left[\frac{CODE}{2^N} \right] + 3.5 \text{ mA} \quad (3)$$

For a 4-mA to 20-mA output range:

$$IOUT_x = 16 \text{ mA} \cdot \left[\frac{CODE}{2^N} \right] + 4 \text{ mA} \quad (4)$$

For a -24-mA to 24-mA output range:

$$IOUT_x = 48 \text{ mA} \cdot \left[\frac{CODE}{2^N} \right] - 24 \text{ mA} \quad (5)$$

Where:

- *CODE* is the decimal equivalent of the code loaded to the DAC.
- *N* is the bits of resolution; 16.

Feature Description (continued)

8.3.2 Voltage Output Stage

The voltage output stage as conceptualized in [Figure 102](#) provides the voltage output according to the DAC code and the output range setting. The output range can be programmed as 0 V to +5 V or 0 V to +10 V for unipolar output mode, and ± 5 V or ± 10 V for bipolar output mode. In addition, an option is available to increase the output voltage range by 20%. The output current drive can be up to 10 mA. The output stage has short-circuit current protection that limits the output current to 16 mA, this limit can be changed to 8 mA, 20 mA or 24mA via writing bits 15 and 14 of address 0x04. This minimum headroom and footroom for the voltage output stage is automatically maintained when the Buck-Boost converter is used to generate these supplies. However, when using an external supply for VPOS_IN_x and VNEG_IN_x pin (Buck-Boost converter disabled) the minimum headroom and footroom as per must be maintained. In this case, the [Recommended Operating Conditions](#) shows the maximum allowable difference between VPOS_IN_x and VNEG_IN_x.

The voltage output is designed to drive capacitive loads of up to 1 μ F. For loads greater than 20 nF, an external compensation capacitor can be connected between CCOMP_x and VOUT_x to keep the output voltage stable at the expense of reduced bandwidth and increased settling time. Note that, a step response (due to input code change) on the voltage output pin loaded with large capacitive load (> 20 nF) will trigger the short circuit limit circuit of the output stage. This will result in setting the short circuit alarm status bits. Therefore, it is recommended to use slew rate control for large step change, when the voltage output pin is loaded with high capacitive loads.

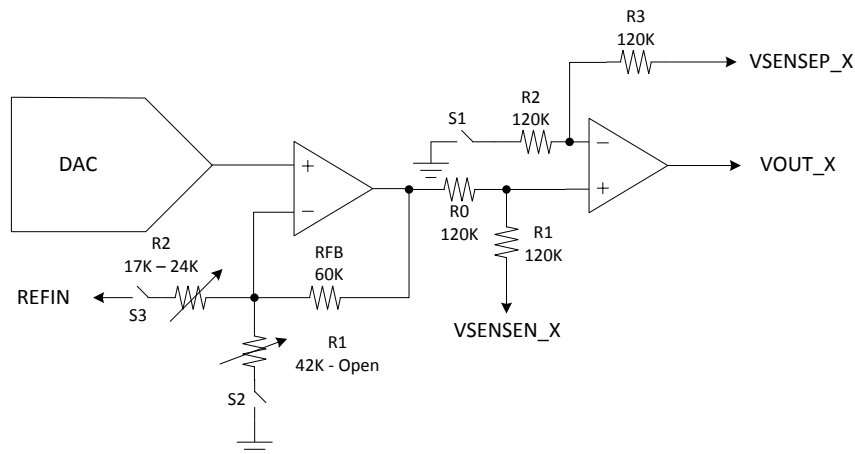

Copyright © 2016, Texas Instruments Incorporated

Figure 102. Voltage Output

The VSENSEP_x pin is provided to enable sensing of the load. Ideally, it is connected to VOUT_x at the terminals. Additionally, it can also be used to connect remotely to points electrically "nearer" to the load. This allows the internal output amplifier to ensure that the correct voltage is applied across the load as long as headroom is available on the power supply. However, if this line is cut, the amplifier loop would be broken. Therefore, an optional resistor can be used between VOUT_x and VSENSEP_x to prevent this.

The VSENSE_N_x pin can be used to sense the remote ground and offset the VOUT pin accordingly. The VSENSE_N_x pin can sense a maximum of ± 7 V difference from the PBKG pin of the DAC8775.

The 16-bit data can be written to DAC8775 as shown in DAC data registers, see [Table 5](#) and [Table 6](#).

For unipolar output mode:

$$VOUT_x = VREFIN \cdot GAIN \cdot \left[\frac{CODE}{2^N} \right] \quad (6)$$

For bipolar output mode:

$$VOUT_x = VREFIN \cdot GAIN \cdot \left[\frac{CODE}{2^N} \right] - \frac{GAIN \cdot VREFIN}{2} \quad (7)$$

Feature Description (continued)

Where:

- *CODE* is the decimal equivalent of the code loaded to the DAC.
- *N* is the bits of resolution; 16.
- *VREFIN* is the reference voltage; for internal reference, *VREFIN* = +5 V.
- *GAIN* is automatically selected for a desired voltage output range as shown in 表 7.

8.3.3 Buck-Boost Converter

The DAC8775 includes a Buck-Boost Converter for each channel to minimize the power dissipation of the chip and provides significant system integration. This Buck-Boost converter is based on a Single Inductor Multiple Output (SIMO) architecture and requires a single inductor (per channel) to simultaneously generate all the analog power supplies required by the chip. The Buck-Boost converters utilize three on-chip switches (shown in 图 103) which are synchronously controlled via current mode control logic. These converters are designed to work in discontinuous conduction mode (DCM) with an external inductor (per channel) of value 100 μ H connected between *LN_x* and *LP_x* pins (see [Buck-Boost Converter External Component Selection](#) section). The peak inductor current is limited to a value of 0.5 A internally.

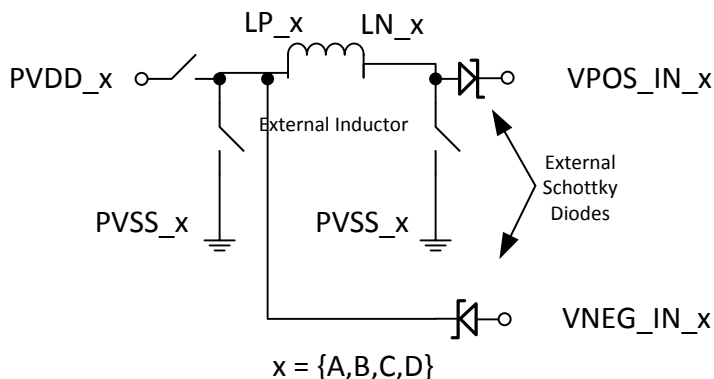

Copyright © 2016, Texas Instruments Incorporated

图 103. Buck-Boost Converter

These Buck-Boost converters employ a variable switching frequency technique. This technique increases the converter efficiency at all loads by automatically reducing the switching frequency at light loads and increasing it at heavy loads. At no load condition, the converter stops switching completely until the load capacitor discharges by a preset voltage. At this point the converter automatically starts switching and recharges the load capacitor(s). In addition to saving power at all loads, this technique ensures low switching noise on the converter outputs at light loads. The minimum load capacitor for these Buck-Boost converters is 10 μ F. This capacitor must be connected between the schottky diode(s) and ground (0 V) for each arm of each Buck-Boost converter (A, B, C, D). The Buck-Boost converter, when enabled, generates ripple on the supply pins (*VPOS_IN_x* and *VNEG_IN_x*). This ripples is typically attenuated by the power supply rejection ratio of the output amplifiers (*IOUT_x* or *VOUT_x*) and appears as noise on the output pin of the amplifiers (*IOUT_x* and *VOUT_x*). A larger load capacitor in combination with additional filter (see [Application Information](#) section) reduces the output ripple at the expense of increasing settling time of the converter output.

The input voltage to the Buck-Boost converters (pin *PVDD_x*) can vary from +12 V to +36 V. These outputs can be individually enabled or disabled via the user SPI interface (see Commands in 表 5 and 表 6).

8.3.3.1 Buck-Boost Converters Outputs

Each of the four Buck-Boost converters can be used to provide power to the current output stage or the voltage output stage by enabling the respective Buck-Boost converter and connecting the power supplies as shown in 图 104. Additional passive filters can optionally be added between the schottky diode and input supply pins (*VPOS_IN_x* and *VNEG_IN_x*) to attenuate the ripple feeding into the *VPOS_IN_x* and *VNEG_IN_x* pin.

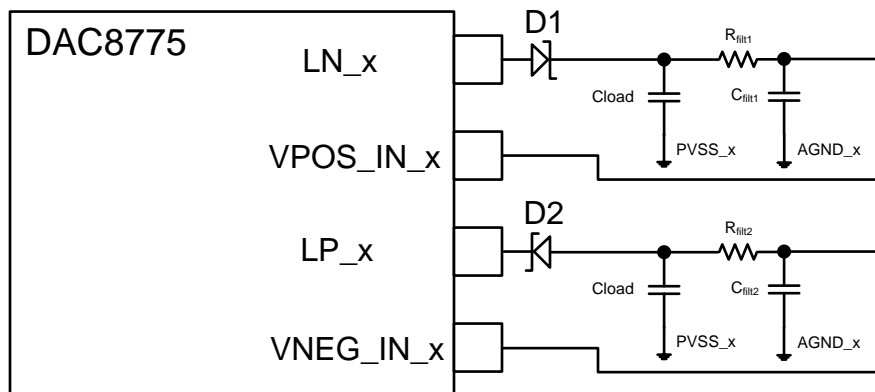
Feature Description (continued)

Copyright © 2016, Texas Instruments Incorporated

FIG 104. Buck-Boost Converter Positive and Negative Outputs
8.3.3.2 Selecting and Enabling Buck-Boost Converters

The analog outputs of the Buck-Boost converters can be enabled in two different ways: Current Output Mode or Voltage Output Mode. Any and all combination of the DAC8775 Buck-Boost converters can be selected by writing to address 0x06 (see Table 5). The positive/negative arm of the selected Buck-Boost converter can be enabled via writing to address 0x07 (see Table 6). Note that, VNEG_IN_x is internally shorted to PBKG when the negative arm of Buck-Boost converter is not enabled.

When used in voltage output mode, the Buck-Boost converter generates a constant ± 15.0 V for the positive and negative power supplies. Alternatively this constant voltage may be modified by the clamp register setting for each channel.

When used in current output mode the Buck-Boost converter generates the positive and negative power supply based on the RANGE setting, for example the negative power supply is only generated for ± 24 mA range.

The minimum voltage that the Buck-Boost converter can generate on the VPOS_IN_x pin is 4.96 V with a typical efficiency of 75% at PVDD_x = 12 V and a load current of 24 mA, thus significantly minimizing power dissipation on chip. The maximum voltage that the Buck-Boost converter can generate on the VPOS_IN_x pin is 32 V. Similarly, the minimum voltage that the Buck-Boost converter can generate on the VNEG_IN_x pin is -18.0 V. The maximum voltage that the Buck-Boost converter can generate on the VNEG_IN_x pin is -5.0 V.

8.3.3.3 Configurable Clamp Feature and Current Output Settling Time

A large signal step on the output pin IOOUT_x (for example 0 mA to 24 mA) with a load of 1 K Ω would require that the respective Buck-Boost converter change the output voltage on the VPOS_IN_x pin from 4 V to 27 V. Thus, the current output settling time will be dominated by the settling time of the VPOS_IN_x voltage. A trade off can be made to reduce the settling time at the expense of power saving by increasing the minimum voltage that the respective Buck-Boost converter generates on the positive output.

The DAC8775 implements a configurable clamp feature. This feature allows multiple modes of operation based on CCLP[1:0] and HSCLMP bits (see Table 6).

8.3.3.3.1 Default Mode - CCLP[1:0] = "00" - Current Output Only

This is the default mode of operation, CCLP[1:0] = "00" for Buck-Boost converter is to be in full tracking mode. The minimum voltage generated on VPOS_IN_x in this case is 4 V. The Buck-Boost converter varies the positive and negative outputs adaptively such that the voltage across these outputs and IOOUT_x pins is ≤ 3 V. This is accomplished by internally feeding back the voltage across the current output PMOS and NMOS to the respective Buck-Boost converter control circuit. For example, for a load current of 24 mA flowing through a load resistance of 1 K Ω , the generated voltage at the VPOS_IN_x pin will be around 27 V.

Feature Description (continued)

8.3.3.3.2 Fixed Clamp Mode - CCLP[1:0] = "01" - Current and Voltage Output

In this mode of operation, the user can over-ride the default operation by writing "01" to CCLP[1:0]. The minimum voltage generated on VPOS_IN_x and VNEG_IN_x can be adjusted by writing to PCLMP[3:0] / NCLMP[3:0] (address 0x07). The voltage setting for current output and voltage output are specified in [表 6](#).

8.3.3.3.3 Auto Learn Mode - CCLP[1:0] = "10" - Current Output Only

In this mode, the device automatically senses the load on the current output terminal and sets the minimum voltage generated on VPOS_IN_x terminals to a fixed value. The value is calculated such that for any code change, the settling time is dependent only on the DAC settling time. For example, with a load of 250 Ω and a maximum current of 24 mA, the Buck-Boost output voltage is set as 9 - 12 V. This achieves the maximum power saving without sacrificing settling time because the Buck-Boost output is fixed.

In order to ensure the correct operation of auto-learn mode, following steps below must be followed.

1. The device must be enabled in full tracking mode, CCLP[1:0] = "00".
2. Current output is enabled and a code greater than 4000h should be written to the DAC.
3. Write CCLP[1:0] = "10" to enable auto learn mode.

At this point, the clamp register (PCLMP - address 0x07) is populated with the appropriate settings. The clamp status bit CLST (address 0x0B) is set once the clamp register is populated indicating the completion of this process. In this mode the PCLMP bits are read only. Typically, this process of sensing the load is done only once after power up. In order to re initiate this process, the CCLP bits must be rewritten with "10".

8.3.3.3.4 High Side Clamp (HSCLMP)

The default maximum positive voltage that the Buck-Boost converter can generate is 32 V. However, this voltage can be reduced to 26 V by writing '1' to HSCLMP bit (address 0x0E, [表 6](#)). Note that this feature can be enabled or disabled per channel by selecting the corresponding channel (address 0x03, [表 6](#)).

8.3.3.4 Buck-Boost Converters and Open Circuit Current Output

In normal operating condition when current output is loaded with a resistive load, the Buck-Boost converter varies the positive and negative outputs adaptively such that the voltage across these outputs and IOU_x pins is ≤ 3 V. However, if the current output is in open circuit condition, the Buck-Boost converter output would rail to fixed voltages as described in [表 1](#).

表 1. Open Circuit IOU with Buck-Boost Converter

| BUCK-BOOST POSITIVE ARM | BUCK-BOOST NEGATIVE ARM | IOU RANGE | IOU PIN VOLTAGE | VPOS_IN_x | VNEG_IN_x |
|-------------------------|-------------------------|-------------------------------|-----------------|-----------|-----------|
| Enabled | Enabled | All Ranges | ≥ 0 V | 20 V | -5 V |
| Enabled | Enabled | ± 24 mA only | < 0 V | 4 V | -20 V |
| Enabled | Disabled | All ranges except ± 24 mA | ≥ 0 V | 32 V | 0 V |

8.3.4 Analog Power Supply

After power up it is required that a hardware reset is issued using the RESET pin.

The DAC8775 is design to operate with a single power supply (12 V to 36 V) using integrated Buck-Boost converter. In this mode, pins PVDD_x and AVDD must be tied together and driven by the same power supply. VPOS_INx and VNEG_IN_x will be enabled as programmed by the device registers. It is recommended that DVDD is applied first to reduce output transients.

The DAC8775 can also be operated without using the integrated Buck-Boost converter. In this mode, pins PVDD_x, AVDD, and VPOS_IN_x must be tied together and driven by the same power supply (12 V to 36 V). In this mode in order to reduce output transients it is recommended that DVDD is applied first, followed by VPOS_IN_x / PVDD_x / AVDD and finally REFIN. Note that in this mode, the minimum required head room and foot room for the output amplifiers must be met.

[Recommended Operating Conditions](#) shows the maximum and minimum allowable limits for all the power supplies when DAC8775 is powered using external power supplies.

8.3.5 Digital Power Supply

The digital power supply to DAC8775 can be internally generated or externally supplied. This is determined by the status of DVDD_EN pin.

When the DVDD_EN pin is left floating, the voltage on DVDD pin is generated via an internal LDO. The typical value of the voltage generated on DVDD pin is 5 V. In this mode, the DVDD pin can also be used to power other digital components on the board. The maximum drive capability of this pin is 10mA. Please note that to ensure stability the minimum load capacitance on this pin is limited to 100 pF, where as the maximum load capacitance is limited to 0.1 μ F.

When the DVDD_EN pin is tied to 0 V, the internal LDO is disabled and the DVDD pin must be powered via an external digital supply.

8.3.6 Internal Reference

The DAC8775 includes an integrated 5-V reference with an initial accuracy of ± 10 mV maximum and a temperature drift coefficient of 10 ppm/ $^{\circ}$ C maximum. A buffered output capable of driving up to 5 mA is available on REFOUT. The internal reference for DAC8775 is disabled by default. To enable the internal reference, REF_EN bit on address 0x02h must be set to '1' (see [表 6](#)).

8.3.7 Power-On-Reset

The DAC8775 contain power on reset circuits which is based on AVDD and DVDD power supplies. After power-on, the power-on-reset circuit ensures that all registers are at their default values (see [表 5](#)). The current, voltage output DACs, and the Buck-Boost converters are disabled. The current output pin is in high impedance state.

The voltage output pin is in a 30k Ω -to-GND state; however, the VSENSEP_x pin is an open circuit. The voltage output pin impedance may be changed to high-impedance by the POC bit setting.

8.3.8 $\overline{\text{ALARM}}$ Pin

The DAC8775 contains an $\overline{\text{ALARM}}$ pin. When one or more of following events occur, the $\overline{\text{ALARM}}$ pin is pulled low:

1. The load on any channel's IOUT_x pin is in open circuit (> 500 μ sec); or
2. The voltage at IOUT_x, when enabled, reaches a level where the accuracy of the output current would be compromised. This condition is detected by monitoring internal voltage levels of the IOUT_x circuitry and will typically be below the specified compliance voltage minimum of 3 V (> 500 μ sec). Note that, when the buck boost converter is enabled in full tracking mode (CCLP[1:0] = "00"), a transient alarm signal can be observed during the current output transition. This condition occurs because the compliance voltage for current output is violated as the buck boost converter is adjusting the power supply. Alternatively the alarm can be programmed to only indicate an alarm once the DC/DC has reached saturation and the compliance voltage condition is still being violated; or
3. The die temperature has exceeded $+150^{\circ}$ C; or
4. The SPI watchdog timer exceeded the timeout period (if enabled); or
5. The SPI frame error check (CRC) encountered an error (if enabled).
6. A short circuit current limit is reached (> 500 μ sec) on any VOUT_x when enabled in voltage output mode.
7. The Buck-Boost converter has reached the maximum output voltage (set by bit HSCLMP, [表 6](#) address 0x0E).

When connecting the $\overline{\text{ALARM}}$ pins of multiple DAC8775 devices together, forming a wired-AND function, the host processor should read the status register of each device to know all the fault conditions that are present.

The $\overline{\text{ALARM}}$ pin continuously monitors the above mentioned conditions and returns to open drain condition if the alarm condition is removed (non-latched behavior - default). For condition (1) mentioned above and Buck-Boost converter used to power the DAC, the ALARM pin if pulled low due to the alarm condition will remain pulled low even after the alarm condition is removed (latched behavior). In this condition the alarm pin can be reset by

1. Resetting the corresponding fault bits in the status register (address 0x0B, [表 6](#)); or
2. Performing software reset (write to address 0x01, [表 6](#)); or
3. Toggling hardware reset pin; or
4. Performing power on reset.

Note that if the alarm action bits are programmed to "10" (AC_IOC[1:0]), the Buck-Boost converter and the current output amplifier are automatically disabled upon the event of open circuit on current output. In this case, the ALARM automatically resets to the default behavior (non-latched behavior).

8.3.9 Power GOOD Bits

Each Buck-Boost converter in DAC8775 has a read only bit called power good (PGx) (address 0x0B, [表 6](#)). This bit is set to logic '1' when both of the following conditions are met:

1. The VPOS_IN_x > 4 V (if enabled) and
2. The VNEG_IN_x < -3 V (if enabled)

The PGx bit indicates the status of the outputs of the enabled Buck-Boost converters. For example if the output of Buck-Boost converter A is the only one enabled, then the PGA bit will be set to a logic '1' only after the positive output pins of the Buck-Boost converter A are ≥ 3.0 V and the negative output pin of Buck-boost converter A is ≤ -3.0 V.

8.3.10 Status Register

Since, DAC8775 contains one $\overline{\text{ALARM}}$ pin for the entire chip, the status of individual fault condition can be checked using the status register. This register (see [Register Maps and Bit Functions](#) section) consists of five types of $\overline{\text{ALARM}}$ status bits (Faults on current and voltage outputs, Over temperature condition, CRC errors, Watchdog timeout and Buck-Boost converter power good) and two status bit (User toggle, Auto Learn status). The device continuously monitors these conditions. When an alarm occurs, the ALARM pin is pulled low and the corresponding status bit is set ('1'). Whenever one of these status bits is set, it remains set until the user clears it by writing '1' to corresponding bit on address 0x0B. The status bit can also be cleared by performing a hardware reset, software reset, or power-on reset, note that it takes a minimum of 8 μsec for the status register to get reset. These bits are reasserted if the ALARM condition continues to exist in the next monitoring cycle.

8.3.11 Status Mask

The $\overline{\text{ALARM}}$ pin for DAC8775 is triggered by any of the alarm conditions (see [ALARM Pin](#) section). However, these different alarm conditions can be masked from creating the alarm signal at the pin by using the status mask register. The status mask register (address 0x0C, [Table 6](#)) has the same bit order as the status register except that it can be set to mask any or all status bits that create the alarm signal.

8.3.12 Alarm Action

The DAC8775 implements an alarm action register (address 0x0D, [Table 6](#)). By writing to this register, the user can select the action that the device will take automatically in case of a specific alarm condition. In case, different settings are chosen for different alarm conditions, the following priority (high to low) will be considered when taking action:

1. Over temperature alarm
2. Output fault alarm
3. CRC error/Watchdog timer fault alarm

This device also contains a 6-bit alarm code register (address 0x0E, [表 6](#)) which can be loaded to the DACs if the alarm action register is set to "01". Note that the alarm code, once set, remains set even if the alarm condition is removed. Also note that the alarm action change to the programmed code is a step function even if slew rate control is enabled.

8.3.13 Watchdog Timer

This feature is useful to ensure that communication between the host processor and the DAC8775 has not been lost. It can be enabled by setting the WEN (address 0x03) bit to '1', see [Table 6](#). The watchdog timeout period can be set using the WPD[1:0] address 0x03) bits. The timer period is based off an internal oscillator with a typical value of 8 MHz.

If enabled, the chip must have an SPI frame with 0x10 as the write address byte written to the device within the programmed timeout period. Otherwise, the $\overline{\text{ALARM}}$ pin asserts low and the WDT bit (address 0x0B) of the status register is set to '1'. The WDT bit is set to '0' with a software/hardware reset, or by disabling the watchdog timer (WEN = '0'), or powering down the device.

When using multiple DAC8775 devices in a daisy-chain configuration, the open-drain $\overline{\text{ALARM}}$ pins of all devices can be connected together to form a wired-AND network. The watchdog timer can be enabled in any number of the devices in the chain although enabling it in one device in the chain should be sufficient. The wired-AND ALARM pin may get pulled low because of the simultaneous presence of different trigger conditions in the devices in the daisy-chain. The host processor should read the status register of each device to know all the fault conditions present in the chain.

8.3.14 Programmable Slew Rate

The slew rate control feature allows the user to control the rate at which the output voltage or current changes. This feature is disabled by default and can be enabled for the selected channel by writing logic '1' to the SREN bit at address 0x04 (see [Table 6](#)). With the slew rate control feature disabled, the output changes smoothly at a rate limited by the output drive circuitry and the attached load.

With this feature enabled, the output does not slew directly between the two values. Instead, the output steps digitally at a rate defined by bits [2:0] (SR_STEP) and bits [3:0] (SRCLK_RATE) on address 0x04 (see [Table 6](#)). SR_RATE defines the rate at which the digital slew updates; SRCLK_STEP defines the amount by which the output value changes at each update. [Table 6](#) shows different settings for SRCLK_STEP and SR_RATE.

The time required for the output to slew over a given range can be expressed as [式 8](#):

$$\text{Slew Time} = \frac{\text{Output Change}}{\text{Step Size} \cdot \text{Update Clock Frequency} \cdot \text{LSB Size}} \quad (8)$$

Where:

- *Slew Time* is expressed in seconds
- *Output Change* is expressed in amps (A) for current output mode or volts (V) for voltage output mode

When the slew rate control feature is enabled, the output changes happen at the programmed slew rate. This configuration results in a staircase formation at the output. If the CLR pin is asserted, the output slews to the zero-scale value at the programmed slew rate. When a new DAC data is written, the output starts slewing to the new value at the slew rate determined by the current DAC code and the new DAC data. The update clock frequency for any given value is the same for all output ranges. The step size, however, varies across output ranges for a given value of step size because the LSB size is different for each output range.

Note that disabling the slew rate feature while the DAC is executing the slew rate command will abort the slew rate operation and the DAC output will stay at the last code after which the slew rate disable command was acknowledged.

8.3.15 HART Interface

On the DAC8775, digital communication such as HART can be modulated onto the input signal for each channel.

In the case where the RANGE (address 0x04) bits are programmed such that the IOUT_x is enabled, the external HART signal (ac voltage; 500 mV_{PP}, 1200 Hz and 2200 Hz) can be capacitively coupled in through the HARTIN_x pin and transferred to a current that is superimposed on the current output. The HARTIN_x pin has a typical input impedance of 20 kΩ to 30 kΩ, depending on the selected current output range, which together with the input capacitor used to couple the external HART signal into the HARTIN_x pin can be used to form a high-pass filter to attenuate frequencies below the HART bandpass region. In addition to this filter, an external passive filter is recommended to complete the filtering requirements of the HART specifications. [Figure 105](#) illustrates the output current versus time operation for a typical HART interface.

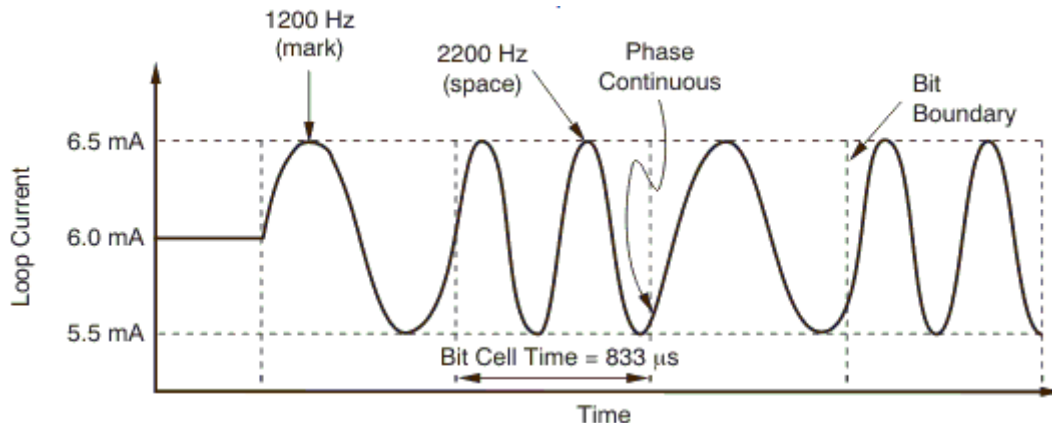

Note: DC current = 6 mA.

图 105. Output Current vs Time

The HART pin for the selected channel can be enabled by writing logic '1' to the HTEN bit at address 0x04 (see 表 5 and 表 6).

8.4 Device Functional Modes

8.4.1 Serial Peripheral Interface (SPI)

The device is controlled over a versatile four-wire serial interface (SDIN, SDO, SCLK, and $\overline{\text{SYNC}}$) that operates at clock rates of up to 25 MHz and is compatible with SPI, QSPI™, Microwire™, and digital signal processing (DSP) standards. The SPI communication command consists of a write address byte and a data word for a total of 24 bits (when CRC is disabled). The timing for the digital interface is shown in the [Timing Requirements: Write and Readback Mode](#) section.

8.4.1.1 Stand-Alone Operation

The serial clock SCLK can be a continuous or a gated clock. When $\overline{\text{SYNC}}$ is high, the SCLK and SDIN signals are blocked and the SDO pin is in a HiZ state. Exactly 24 falling clock edges must be applied before $\overline{\text{SYNC}}$ is brought high. If $\overline{\text{SYNC}}$ is brought high before the 24th falling SCLK edge, then the data written are not transferred into the internal registers. If more than 24 falling SCLK edges are applied before $\overline{\text{SYNC}}$ is brought high, then the last 24 bits are used. The device internal registers are updated from the Shift Register on the rising edge of $\overline{\text{SYNC}}$. In order for another serial transfer to take place, $\overline{\text{SYNC}}$ must be brought low again.

8.4.1.2 Daisy-Chain Operation

For systems that contain more than one device, the SDO pin can be used to daisy-chain multiple devices together. Daisy-chain operation can be useful for system diagnostics and in reducing the number of serial interface lines. The daisy chain feature can be enabled by writing logic '0' to DSDO bit address 0x03 (see [Table 6](#)), the SDO pin is set to HiZ when DSDO bit is set to 1. By connecting the SDO of the first device to the SDIN input of the next device in the chain, a multiple-device interface is constructed, as [Figure 11](#) illustrates.

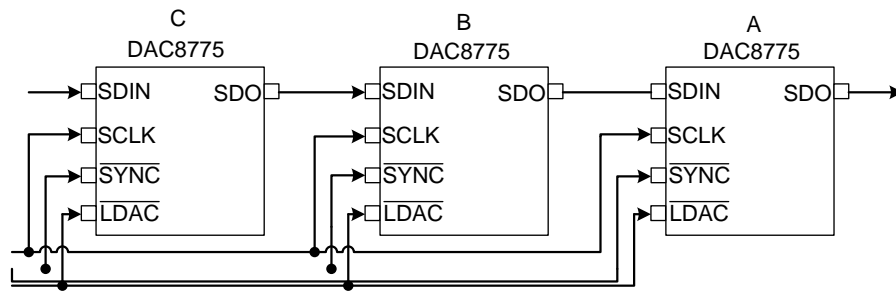
Device Functional Modes (continued)

Copyright © 2016, Texas Instruments Incorporated

图 106. Three DAC8775s in Daisy-Chain Mode

The DAC8775 provides two modes for daisy-chain operation: normal and transparent. The TRN bit in the Reset config register determines which mode is used. In Normal mode (TRN bit = '0'), the data clocked into the SDIN pin are transferred into the shift register. The first falling edge of $\overline{\text{SYNC}}$ starts the operating cycle. SCLK is continuously applied to the SPI Shift Register when $\overline{\text{SYNC}}$ is low. If more than 24 clock pulses are applied, the data ripple out of the shift register and appear on the SDO line. These data are clocked out on the rising edge of SCLK and are valid on the falling edge. By connecting the SDO pin of the first device to the SDIN input of the next device in the chain, a multiple-device interface is constructed. Each device in the system requires 24 clock pulses. Therefore, the total number of clock cycles must equal $24 \times N$, where N is the total number of DAC8775s in the chain. When the serial transfer to all devices is complete, $\overline{\text{SYNC}}$ is taken high. This action latches the data from the SPI Shift registers to the device internal registers synchronously for each device in the daisy-chain, and prevents any further data from being clocked in. Note that a continuous SCLK source can only be used if $\overline{\text{SYNC}}$ is held low for the correct number of clock cycles. For gated clock mode, a burst clock containing the exact number of clock cycles must be used and $\overline{\text{SYNC}}$ must be taken high after the final clock in order to latch the data.

In Transparent mode (address 0x02h, TRN bit = '1' 表 6), the data clocked into SDIN are routed to the SDO pin directly; the Shift Register is bypassed. When SCLK is continuously applied with $\overline{\text{SYNC}}$ low, the data clocked into the SDIN pin appear on the SDO pin almost immediately (with approximately a 12 ns delay); there is no 24 clock delay, as there is in normal operating mode. While in Transparent mode, no data bits are clocked into the Shift Register, and the device does not receive any new data or commands. Putting the device into transparent mode eliminates the 24 clock delay from SDIN to SDO caused by the Shift Register, thus greatly speeding up the data transfer. For example, consider three DAC8775s (C, B, and A) in a daisy-chain configuration (see Figure 11). The data from the SPI controller are transferred first to C, then to B, and finally to A. In normal daisy-chain operation, a total of 72 clocks are needed to transfer one word to A. However, if C and B are placed into Sleep mode, the first 24 data bits are directly transferred to A (through C and B); therefore, only 24 clocks are needed.

To wake the device up from transparent mode and return to normal operation, the hardware $\overline{\text{RESET}}$ pin must be toggled.

8.4.2 SPI Shift Register

The SPI Shift Register is 24 bits wide (refer to the [Frame Error Checking](#) section for 32-bit frame mode). The default 24-bit input frame consists of an 8-bit address byte followed by a 16-bit data word as shown in 表 2.

表 2. Default SPI Frame

| BIT 23:BIT 16 | BIT 15:BIT 0 |
|---------------|--------------|
| Address byte | Data word |

8.4.3 Write Operation

A typical write to program a channel of the DAC8775 consists of writing to the following registers in the sequence shown in [Figure 12](#).



图 107. Typical Write to DAC8775

8.4.4 Read Operation

A read operation is accomplished when DB 23 is '1' (see [Table 3](#)). A no-operation (NOP) command should follow the read operation in order to clock out an addressed register. The read register value is output MSB first on SDO on successive falling edges of SCLK.

表 3. Register Read Address Functions⁽¹⁾

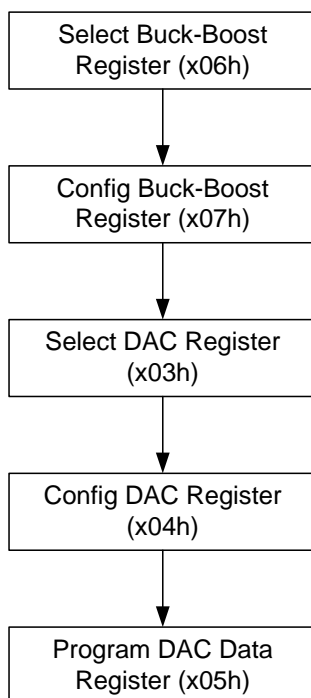
| ADDRESS BYTE | |
|----------------|--------------------|
| DB23 | DB 22: DB 16 |
| Read/Write Bit | Register Addresses |

(1) 'X' denotes *don't care* bits.

8.4.5 Updating the DAC Outputs and $\overline{\text{LDAC}}$ Pin

Depending on the status of both $\overline{\text{SYNC}}$ and $\overline{\text{LDAC}}$, and after data have been transferred into the DAC Data registers, the DAC outputs can be updated either in asynchronous mode or synchronous mode.

8.4.5.1 Asynchronous Mode

In this mode, the $\overline{\text{LDAC}}$ pin is set low before the rising edge of $\overline{\text{SYNC}}$. This action places the DAC8775 into Asynchronous mode, and the $\overline{\text{LDAC}}$ signal is ignored. The DAC latches are updated immediately when $\overline{\text{SYNC}}$ goes high.

8.4.5.2 Synchronous Mode

To use this mode, set $\overline{\text{LDAC}}$ high before the rising edge of $\overline{\text{SYNC}}$, and then take $\overline{\text{LDAC}}$ low after $\overline{\text{SYNC}}$ goes high. In this mode, when $\overline{\text{LDAC}}$ stays high, the DAC latch is not updated; therefore, the DAC output does not change. The DAC latch is updated by taking $\overline{\text{LDAC}}$ low any time after a certain delay from the rising edge of $\overline{\text{SYNC}}$ (see [Figure 1](#)). If this delay requirement is not satisfied, invalid data are loaded. Refer to the [Timing Requirements: Write and Readback Mode](#) section for details.

8.4.6 Hardware $\overline{\text{RESET}}$ Pin

When the $\overline{\text{RESET}}$ pin is low, the device is in hardware reset. All the analog outputs (VOUT_A to VOUT_D and IOUT_A to IOUT_D), all the registers except the POC register, and the DAC latches are set to the default reset values. In addition, the Gain and Zero registers are loaded with default values, communication is disabled, and the signals on $\overline{\text{SYNC}}$ and SDIN are ignored (note that SDO is in a high-impedance state). When the $\overline{\text{RESET}}$ pin is high, the serial interface returns to normal operation and all the analog outputs (VOUT_A to VOUT_D and IOUT_A to IOUT_D) maintain the reset value until a new value is programmed.

8.4.7 Hardware CLR Pin

The CLR pin is an active high input that should be low for normal operation. When this pin is a logic '1', all the outputs are cleared to either zero-scale code or midscale code depending on the status of the CLSLx bit (see [Reset Register \(address = 0x01\) \[reset = 0x0000\]](#)). While CLR is high, all $\overline{\text{LDAC}}$ pulses are ignored. When CLR is taken low again, the DAC outputs remain cleared until new data is written to the DACs. The contents of the Offset registers, Gain registers, and DAC input registers are not affected by taking CLR high. Note that the clear action will result in the outputs clearing to the default value instantaneously even if slew rate control is enabled.

8.4.8 Frame Error Checking

If the DAC8775 is used in a noisy environment, error checking can be used to check the integrity of SPI data communication between the device and the host processor. This feature can be enabled by setting the CREN bit address 0x03 (see [Table 6](#)).

The frame error checking scheme is based on the CRC-8-ATM (HEC) polynomial $x^8 + x^2 + x + 1$ (that is, 10000011). When error checking is enabled, the SPI frame width is 32 bits, as shown in [Table 1](#). The normal 24-bit SPI data are appended with an 8-bit CRC polynomial by the host processor before feeding it to the device. For a register readback, the CRC polynomial is output on the SDO pins by the device as part of the 32 bit frame.

Note that the user has to start with the default 24 bit frame and enable frame error checking through the CREN bit and switch to the 32 bit frame. Alternatively, the user can use a 32-bit frame from the beginning and pad the 8 MSB bits as the device will only use the last 24 bits until the CRCEN bit is set. The frame length has to be carefully managed, especially when using daisy-chaining in combination with CRC checking to ensure correct operation.

表 4. SPI Frame with Frame Error Checking Enabled

| BIT 31:BIT 8 | BIT 7:BIT 0 |
|-----------------------|----------------------|
| Normal SPI frame data | 8-bit CRC polynomial |

The DAC8775 decodes the 32-bit input frame data to compute the CRC remainder. If no error exists in the frame, the CRC remainder is zero. When the remainder is non-zero (that is, the input frame has single- or multiple-bit errors), the $\overline{\text{ALARM}}$ pin asserts low and the CRE bit of the status register (address 0x0B) is also set to '1'. Note that the $\overline{\text{ALARM}}$ pin can be asserted low for any of the different conditions as explained in the [ALARM Pin](#) section. The CRE bit is set to '0' with a software or hardware reset, or by disabling the frame error checking, or by powering down the device. In the case of a CRC error, the specific SPI frame is blocked from writing to the device.

Frame error checking can be enabled for any number of DAC8775 devices connected in a daisy-chain configuration. However, it is recommended to enable error checking for none or all devices in the chain. When connecting the $\overline{\text{ALARM}}$ pins of all combined devices, forming a wired-AND function, the host processor should read the status register of each device to know all the fault conditions present in the chain. For proper operation, the host processor must provide the correct number of SCLK cycles in each frame, taking care to identify whether or not error checking is enabled in each device in the daisy-chain.

8.4.9 DAC Data Calibration

Each channel of the DAC8775 contains a dedicated user calibration register set. This feature allows the user to trim the system gain and offset errors. Both the voltage output and the current output have common user calibration registers available. The user calibration feature is disabled by default. To enable this feature for a selected channel(s), the CLEN bit (DB0) on address 0x08 must be set to logic '1' (see [Table 6](#)).

8.4.9.1 DAC Data Gain and Offset Calibration Registers

The DAC calibration register set includes one gain calibration and one offset calibration register (16 bits for DAC8775) per channel (address 0x09 and 0x0A). The range of gain adjustment is typically $\pm 50\%$ of full-scale with 1 LSB per step. The power-on value of the gain register is 0x8000 which is equivalent to a gain of 1. The offset code adjustment is typically $\pm 32,768$ LSBs with 1 LSB per step. The input data format of the gain register is unsigned straight binary, and the input data format of the offset register is twos complement. The gain and offset calibration is described by 式 9.

$$\text{CODE_OUT} = \left[\text{CODE} \cdot \left(\frac{\text{User_Gain} + 2^{15}}{2^{16}} \right) + \text{User_Zero} \right] \quad (9)$$

Where:

- *CODE* is the decimal equivalent of the code loaded to the DAC.
- *VREFIN* is the reference voltage; for internal reference, *VREFIN* = +5 V.
- *GAIN* is automatically selected for a desired voltage output range as shown in 表 7.
- *User_Offset* is the signed 16-bit code in the offset register.
- *User_GAIN* is the unsigned 16-bit code in the gain register.

It is important to note that this is a purely digital implementation and the output is still limited by the programmed value at both ends of the voltage or current output range. Therefore, the user must remember that the correction only makes sense for endpoints inside of the true device end points. If the user desires to correct more than just the actual device error, for example a system offset, the valid range for the adjustment would change accordingly and must be taken into account. This range is set by the RANGE bits as described in Table 6.

8.5 Register Maps

8.5.1 DAC8775 Commands

表 5. Address Functions

| ADDRESS BYTE | FUNCTION | READ/WRITE | PER CHANNEL | POWER-ON RESET VALUE |
|--------------|---|------------|-------------|----------------------|
| 0x00 | No operation (NOP) | Write | No | 0x0000 |
| 0x01 | Reset register | Read+Write | No | 0x0000 |
| 0x02 | Reset config register | Read+Write | No | 0x0000 |
| 0x03 | Select DAC register | Read+Write | No | 0x0000 |
| 0x04 | Configuration DAC register | Read+Write | Yes | 0x0000 |
| 0x05 | DAC data register | Read+Write | Yes | 0x0000 |
| 0x06 | Select Buck-Boost converter register | Read+Write | No | 0x0000 |
| 0x07 | Configuration Buck-Boost converter register | Read+Write | Yes | 0x0000 |
| 0x08 | DAC channel calibration enable register | Read+Write | Yes | 0x0000 |
| 0x09 | DAC channel gain calibration register | Read+Write | Yes | 0x0000 |
| 0x0A | DAC channel offset calibration register | Read+Write | Yes | 0x0000 |
| 0x0B | Status register | Read+Write | No | 0x1000 |
| 0x0C | Status mask register | Read+Write | No | 0x0000 |
| 0x0D | Alarm action register | Read+Write | No | 0x0000 |
| 0x0E | User alarm code register | Read+Write | Yes | 0x0000 |
| 0x0F | Reserved | N/A | N/A | N/A |
| 0x10 | Write watchdog timer reset | Write | No | 0x0000 |
| 0x11 | Device ID | Read | No | 0x0000 |
| 0x12 - 0xFF | Reserved | N/A | N/A | N/A |

Note that, in order to write to (or read from) a per channel address, corresponding Buck-Boost converter and DAC channel must be selected using commands 0x06 and 0x03.

8.5.2 Register Maps and Bit Functions

表 6. Register Map

| ADDRESS | BITS | | | | | | | | | | | | | | | |
|---------|----------------|----|------|--------|-----------------|--------|--------|------------|-----------------|------|-------------|--------|-------------|------------|-------------|------|
| | 15 | 14 | 13 | 12 | 11 | 10 | 9 | 8 | 7 | 6 | 5 | 4 | 3 | 2 | 1 | 0 |
| 0x01 | x | x | x | x | x | x | x | x | x | x | x | x | x | x | x | RST |
| 0x02 | x | x | x | CLREND | CLRENC | CLRENB | CLRENA | x | x | x | x | REF_EN | TRN | CLR | POC | UBT |
| 0x03 | x | x | x | CLSLD | CLSLC | CLSLB | CLSLA | CHD | CHC | CHB | CHA | DSDO | CREN | WPD[1:0] | | WEN |
| 0x04 | SCLIM[1:0] | | HTEN | OTEN | SRCLK_RATE[3:0] | | | | SR_STEP[2:0] | | | SREN | RANGE[3:0] | | | |
| 0x05 | DAC_DATA[15:0] | | | | | | | | | | | | | | | |
| 0x06 | x | x | x | x | x | x | x | x | x | x | x | x | DCD | DCC | DCB | DCA |
| 0x07 | x | x | x | x | CCLP[1:0] | | | PCLMP[3:0] | | | NCLMP[3:0] | | | PNSEL[1:0] | | |
| 0x08 | x | x | x | x | x | x | x | x | x | x | x | x | x | x | x | CLEN |
| 0x09 | UGAIN[15:0] | | | | | | | | | | | | | | | |
| 0x0A | UOFF[15:0] | | | | | | | | | | | | | | | |
| 0x0B | x | x | x | CLST | WDT | PGD | PGC | PGB | PGA | UTGL | CRE | TMP | FD | FC | FB | FA |
| 0x0C | x | x | x | x | MWT | x | x | x | x | x | MCRE | MTMP | MFD | MFC | MFB | MFA |
| 0x0D | x | x | x | x | x | x | x | x | AC_CRE_WDT[1:0] | | AC_IOC[1:0] | | AC_VSC[1:0] | | AC_TMP[1:0] | |
| 0x0E | ACODE[15:10] | | | | | | HSCLMP | 0 | x | x | x | x | x | x | x | x |
| 0x10 | x | x | x | x | x | x | x | x | x | x | x | x | x | x | x | RWD |
| 0x11 | x | x | x | x | x | x | x | x | x | x | x | x | x | DID[2:0] | | |

表 7. Voltage Output GAIN vs DAC Range

| BIT 3: Bit 0 (RANGE) | GAIN |
|----------------------|----------------------|
| 0000 | 1 |
| 0001 | 2 |
| 0010 | 2 |
| 0011 | 4 |
| 1000 | 1.2 (20% Over-range) |
| 1001 | 2.4 (20% Over-range) |
| 1010 | 2.4 (20% Over-range) |
| 1011 | 4.8 (20% Over-range) |

8.5.2.1 No Operation Register (address = 0x00) [reset = 0x0000]

☒ 108. No Operation Register

| 15 | 14 | 13 | 12 | 11 | 10 | 9 | 8 |
|----------|----|----|----|----|----|---|---|
| Reserved | | | | | | | |
| W | | | | | | | |
| 7 | 6 | 5 | 4 | 3 | 2 | 1 | 0 |
| Reserved | | | | | | | |
| W | | | | | | | |

LEGEND: R/W = Read/Write; R = Read only; W = Write Only; -n = value after reset

表 8. No Operation Field Descriptions

| Bit | Field | Type | Reset | Description |
|-------|----------|------|----------------------|-------------|
| 15:10 | Reserved | W | 00000000 00000000 | Reserved |

8.5.2.2 Reset Register (address = 0x01) [reset = 0x0000]
图 109. Reset Register

| | | | | | | | |
|----------|----|----|----|----|----|---|-----|
| 15 | 14 | 13 | 12 | 11 | 10 | 9 | 8 |
| Reserved | | | | | | | |
| R/W | | | | | | | |
| 7 | 6 | 5 | 4 | 3 | 2 | 1 | 0 |
| Reserved | | | | | | | RST |
| R/W | | | | | | | R/W |

LEGEND: R/W = Read/Write; R = Read only; -n = value after reset

表 9. Reset Register Field Descriptions

| Bit | Field | Type | Reset | Description |
|------|----------|------|----------------------|---|
| 15:1 | Reserved | R/W | 00000000 00000000 | Reserved |
| 0 | RST | R/W | 0 | Reset. When set, it resets all registers except POC register bit to the respective power-on reset default value. After reset completes the RST bit clears |

8.5.2.3 Reset Config Register (address = 0x02) [reset = 0x0000]
图 110. Reset Config Register

| | | | | | | | |
|----------|----|----|--------|--------|--------|--------|----------|
| 15 | 14 | 13 | 12 | 11 | 10 | 9 | 8 |
| Reserved | | | CLREND | CLRENC | CLRENB | CLRENA | Reserved |
| R/W | | | R/W | R/W | R/W | R/W | R/W |
| 7 | 6 | 5 | 4 | 3 | 2 | 1 | 0 |
| Reserved | | | REF_EN | TRN | CLR | POC | UBT |
| R/W | | | R/W | R/W | R/W | R/W | R/W |

LEGEND: R/W = Read/Write; R = Read only; -n = value after reset

表 10. Reset Config Register Field Descriptions

| Bit | Field | Type | Reset | Description |
|-------|----------|------|-------|---|
| 15:13 | Reserved | R/W | 000 | Reserved |
| 12 | CLREND | R/W | 0 | Clear Enable 0 - DACD hardware and software clear is disabled 1 - DACD hardware and software clear is enabled |
| 11 | CLRENC | R/W | 0 | Clear Enable 0 - DACC hardware and software clear is disabled 1 - DACC hardware and software clear is enabled |
| 10 | CLRENB | R/W | 0 | Clear Enable 0 - DACB hardware and software clear is disabled 1 - DACB hardware and software clear is enabled |
| 9 | CLRENA | R/W | 0 | Clear Enable 0 - DACA hardware and software clear is disabled 1 - DACA hardware and software clear is enabled |
| 8:5 | Reserved | R/W | 0000 | Reserved |
| 4 | REF_EN | R/W | 0 | Internal reference enable/disable 0 - Internal reference disabled (default) 1 - Internal reference enabled |
| 3 | TRN | R/W | 0 | Enable transparent mode (see section "daisy chain operation") |
| 2 | CLR | R/W | 0 | Active high, clears all DAC registers to either zero or full scale based on CLSL bit. After clear completes the CLR bit resets. |

表 10. Reset Config Register Field Descriptions (continued)

| Bit | Field | Type | Reset | Description |
|-----|-------|------|-------|--|
| 1 | POC | R/W | 0 | Power-Off-Condition 0 - IOUT_x to HiZ, VOUT_x to 30K-to-PBKG at power up, hardware or software reset (default) 1 - IOUT_x and VOUT_x to HiZ at power up, hardware and software reset |
| 0 | UBT | R/W | 0 | User Bit - This bit can be used to check if the communication to the chip is working correctly by writing a known value to this bit and reading that value from the status register toggle bit. The toggle register bit UTGL (address 0x0B) is set to the same value as the UBT bit. |

8.5.2.4 Select DAC Register (address = 0x03) [reset = 0x0000]
图 111. Select DAC Register

| | | | | | | | |
|----------|-----|-----|-------|-------|----------|-------|-----|
| 15 | 14 | 13 | 12 | 11 | 10 | 9 | 8 |
| Reserved | | | CLSLD | CLSLC | CLSLB | CLSLA | CHD |
| R/W | | | R/W | R/W | R/W | R/W | R/W |
| 7 | 6 | 5 | 4 | 3 | 2 | 1 | 0 |
| CHC | CHB | CHA | DSDO | CREN | WPD[1:0] | | WEN |
| R/W | R/W | R/W | R/W | R/W | R/W | | R/W |

LEGEND: R/W = Read/Write; R = Read only; -n = value after reset

表 11. Select DAC Register Field Descriptions

| Bit | Field | Type | Reset | Description |
|-------|----------|------|-------|---|
| 15:13 | Reserved | R/W | 000 | Reserved |
| 12 | CLSLD | R/W | 0 | Clear Select 0 - DACD DAC registers cleared to zero scale upon hardware or software clear (default) 1 - DACD DAC registers cleared to mid scale upon hardware or software clear |
| 11 | CLSLC | R/W | 0 | Clear Select 0 - DACC DAC registers cleared to zero scale upon hardware or software clear (default) 1 - DACC DAC registers cleared to mid scale upon hardware or software clear |
| 10 | CLSLB | R/W | 0 | Clear Select 0 - DACB DAC registers cleared to zero scale upon hardware or software clear (default) 1 - DACB DAC registers cleared to mid scale upon hardware or software clear |
| 9 | CLSLA | R/W | 0 | Clear Select 0 - DACA DAC registers cleared to zero scale upon hardware or software clear (default) 1 - DACA DAC registers cleared to mid scale upon hardware or software clear |
| 8 | CHD | R/W | 0 | Channel D selected |
| 7 | CHC | R/W | 0 | Channel C selected |
| 6 | CHB | R/W | 0 | Channel B selected |
| 5 | CHA | R/W | 0 | Channel A selected |
| 4 | DSDO | R/W | 0 | Disable SDO - When set, this bit disables daisy chain operation and SDO pin is set to HiZ, enabled by default |
| 3 | CREN | R/W | 0 | Enable CRC - When set, this bit enables frame error checking, disabled by default |

表 11. Select DAC Register Field Descriptions (continued)

| Bit | Field | Type | Reset | Description |
|-----|----------|------|-------|---|
| 2:1 | WPD[1:0] | R/W | 00 | Watchdog Timer Period 00 - 10 ms (typical) 01 - 51 ms (typical) 10 - 102 ms (typical) 11 - 204 ms (typical) |
| 0 | WEN | R/W | 0 | Enable Watchdog Timer - When set, this bit enables watchdog timer, disabled by default |

8.5.2.5 Configuration DAC Register (address = 0x04) [reset = 0x0000]
☒ 112. Configuration DAC Register

| | | | | | | | |
|--------------|----|------|------|-----------------|----|---|---|
| 15 | 14 | 13 | 12 | 11 | 10 | 9 | 8 |
| SCLIM[1:0] | | HTEN | OTEN | SRCLK_RATE[3:0] | | | |
| R/W | | R/W | R/W | R/W | | | |
| 7 | 6 | 5 | 4 | 3 | 2 | 1 | 0 |
| SR_STEP[2:0] | | | SREN | RANGE[3:0] | | | |
| R/W | | | R/W | R/W | | | |

LEGEND: R/W = Read/Write; R = Read only; -n = value after reset

表 12. Configuration DAC Register Field Descriptions

| Bit | Field | Type | Reset | Description |
|-------|-----------------|------|-------|---|
| 15:14 | SCLIM[1:0] | R/W | 00 | Voltage output short circuit limit 00 - 16 mA (default). Actual value will be between the minimum and maximum values specified in Electrical Characteristics . 01 - 8 mA. Actual value will be between the minimum and maximum values specified in Electrical Characteristics . 10 - 20 mA. Actual value will be between the minimum and maximum values specified in Electrical Characteristics . 11 - 24 mA. Actual value will be between the minimum and maximum values specified in Electrical Characteristics . |
| 13 | HTEN | R/W | 0 | Enable HART - When set, this bit enables HART, disabled by default |
| 12 | OTEN | R/W | 0 | Output Enabled - When set, this bit enables DAC (Voltage or Current) outputs, disabled by default |
| 11:8 | SRCLK_RATE[3:0] | R/W | 0000 | Slew Clock Rate 0000 - DAC updates at 258,065 Hz (default) 0001 - DAC updates at 200,000 Hz 0010 - DAC updates at 153,845 Hz 0011 - DAC updates at 131,145 Hz 0100 - DAC updates at 115,940 Hz 0101 - DAC updates at 69,565 Hz 0110 - DAC updates at 37,560 Hz 0111 - DAC updates at 25,805 Hz 1000 - DAC updates at 20,150 Hz 1001 - DAC updates at 16,030 Hz 1010 - DAC updates at 10,295 Hz 1011 - DAC updates at 8,280 Hz 1100 - DAC updates at 6,900 Hz 1101 - DAC updates at 5,530 Hz 1110 - DAC updates at 4,240 Hz 1111 - DAC updates at 3,300 Hz |
| 7:5 | SR_STEP[2:0] | R/W | 000 | Slew Rate Step Size 000 - 1 LSB (default) 001 - 2 LSB 010 - 4 LSB 011 - 8 LSB 100 - 16 LSB 101 - 32 LSB 110 - 64 LSB 111 - 128 LSB |

表 12. Configuration DAC Register Field Descriptions (continued)

| Bit | Field | Type | Reset | Description |
|-----|------------|------|-------|---|
| 4 | SREN | R/W | 0 | Slew Rate Enabled - When set, this bit enables slew rate feature, disabled by default |
| 3:0 | RANGE[3:0] | R/W | 0000 | Range, Please note that upon changing the range, the DAC output changes based on CLSLx (Address 0x03) 0000 - Voltage output 0 to +5 V (default) 0001 - Voltage output 0 to +10 V 0010 - Voltage output ±5 V 0011 - Voltage output ±10 V 0100 - Current output 3.5 mA to 23.5 mA 0101 - Current output 0 to 20 mA 0110 - Current output 0 to 24 mA 0111 - Current output ±24 mA 1000 - Voltage output 0 to +6 V 1001 - Voltage output 0 to +12 V 1010 - Voltage output ±6 V 1011 - Voltage output ±12 V 11xx - Current output 4 mA to 20 mA |

8.5.2.6 DAC Data Register (address = 0x05) [reset = 0x0000]

☒ 113. DAC Data Register

| | | | | | | | |
|----------------|----|----|----|----|----|---|---|
| 15 | 14 | 13 | 12 | 11 | 10 | 9 | 8 |
| DAC_DATA[15:8] | | | | | | | |
| R/W | | | | | | | |
| 7 | 6 | 5 | 4 | 3 | 2 | 1 | 0 |
| DAC_DATA[7:0] | | | | | | | |
| R/W | | | | | | | |

LEGEND: R/W = Read/Write; R = Read only; -n = value after reset

表 13. DAC Data Register Field Descriptions

| Bit | Field | Type | Reset | Description |
|------|----------------|------|-------|-----------------|
| 15:0 | DAC_DATA[15:0] | R/W | | 16-bit DAC data |

8.5.2.7 Select Buck-Boost Converter Register (address = 0x06) [reset = 0x0000]

☒ 114. Select Buck-Boost Converter Register

| | | | | | | | |
|----------|----|----|----|-----|-----|-----|-----|
| 15 | 14 | 13 | 12 | 11 | 10 | 9 | 8 |
| Reserved | | | | | | | |
| R/W | | | | | | | |
| 7 | 6 | 5 | 4 | 3 | 2 | 1 | 0 |
| Reserved | | | | DCD | DCC | DCB | DCA |
| R/W | | | | R/W | R/W | R/W | R/W |

LEGEND: R/W = Read/Write; R = Read only; -n = value after reset

表 14. Select Buck-Boost Converter Register Field Descriptions

| Bit | Field | Type | Reset | Description |
|------|----------|------|------------------|---------------------------------|
| 15:4 | Reserved | R/W | 00000000 0000 | Reserved |
| 3 | DCD | R/W | 0 | Buck-Boost converter D selected |
| 2 | DCC | R/W | 0 | Buck-Boost converter C selected |
| 1 | DCB | R/W | 0 | Buck-Boost converter B selected |
| 0 | DCA | R/W | 0 | Buck-Boost converter A selected |

8.5.2.8 Configuration Buck-Boost Register (address = 0x07) [reset = 0x0000]
☒ 115. Configuration Buck-Boost Register

| | | | | | | | |
|------------|----|------------|----|-----------|----|------------|---|
| 15 | 14 | 13 | 12 | 11 | 10 | 9 | 8 |
| Reserved | | | | CCLP[1:0] | | PCLMP[3:2] | |
| R/W | | | | R/W | | R/W | |
| 7 | 6 | 5 | 4 | 3 | 2 | 1 | 0 |
| PCLMP[1:0] | | NCLMP[3:0] | | | | PNSEL[1:0] | |
| R/W | | R/W | | | | R/W | |

LEGEND: R/W = Read/Write; R = Read only; -n = value after reset

表 15. Configuration Buck-Boost Register Field Descriptions

| Bit | Field | Type | Reset | Description | | | | | | | | | | | | | | | | | | | | | | | | | | | | | | | | | | | | | | | | | | | | | | | | | | | |
|-------|---------------------|---------------------|-------|---|--|---------------------|---------------------|------|-----------------|---------|------|-------|---------|------|-------|---------|------|-------|-------|------|--------|---------|------|--------|---------|------|--------|---------|------|--------|---------|------|--------|--------|------|--------|--------|------|--------|---------|------|--------|---------|------|--------|---------|------|--------|---------|------|--------|---------|------|--------|---------|
| 15:12 | Reserved | R/W | 0000 | Reserved | | | | | | | | | | | | | | | | | | | | | | | | | | | | | | | | | | | | | | | | | | | | | | | | | | | |
| 11:10 | CCLP[1:0] | R/W | 00 | Buck-Boost converter configurable clamp setting 00 - Buck-Boost converter in full tracking mode (default) 01 - User can write to PCLMP and NCLMP bits 10 - PCLMP bits are populated automatically to optimum value - "Auto Learn mode", User cannot write to PCLMP bits 11 - Invalid | | | | | | | | | | | | | | | | | | | | | | | | | | | | | | | | | | | | | | | | | | | | | | | | | | | |
| 9:6 | PCLMP[3:0] | R/W | 0000 | Buck-Boost converter positive clamp setting, DAC output unloaded - Buck-Boost converter positive arm low side clamp <table border="1" style="width: 100%; border-collapse: collapse;"> <thead> <tr> <th></th> <th>Current Output Mode</th> <th>Voltage Output Mode</th> </tr> </thead> <tbody> <tr><td>0000</td><td>4.0 V (default)</td><td>Invalid</td></tr> <tr><td>0001</td><td>5.0 V</td><td>Invalid</td></tr> <tr><td>0010</td><td>6.0 V</td><td>Invalid</td></tr> <tr><td>0011</td><td>9.0 V</td><td>9.0 V</td></tr> <tr><td>0100</td><td>11.0 V</td><td>Invalid</td></tr> <tr><td>0101</td><td>12.0 V</td><td>Invalid</td></tr> <tr><td>0110</td><td>13.0 V</td><td>Invalid</td></tr> <tr><td>0111</td><td>14.0 V</td><td>Invalid</td></tr> <tr><td>1000</td><td>15.0 V</td><td>15.0 V</td></tr> <tr><td>1001</td><td>18.0 V</td><td>18.0 V</td></tr> <tr><td>1010</td><td>20.0 V</td><td>Invalid</td></tr> <tr><td>1011</td><td>23.0 V</td><td>Invalid</td></tr> <tr><td>1100</td><td>25.0 V</td><td>Invalid</td></tr> <tr><td>1101</td><td>27.0 V</td><td>Invalid</td></tr> <tr><td>1110</td><td>30.0 V</td><td>Invalid</td></tr> <tr><td>1111</td><td>32.0 V</td><td>Invalid</td></tr> </tbody> </table> | | Current Output Mode | Voltage Output Mode | 0000 | 4.0 V (default) | Invalid | 0001 | 5.0 V | Invalid | 0010 | 6.0 V | Invalid | 0011 | 9.0 V | 9.0 V | 0100 | 11.0 V | Invalid | 0101 | 12.0 V | Invalid | 0110 | 13.0 V | Invalid | 0111 | 14.0 V | Invalid | 1000 | 15.0 V | 15.0 V | 1001 | 18.0 V | 18.0 V | 1010 | 20.0 V | Invalid | 1011 | 23.0 V | Invalid | 1100 | 25.0 V | Invalid | 1101 | 27.0 V | Invalid | 1110 | 30.0 V | Invalid | 1111 | 32.0 V | Invalid |
| | Current Output Mode | Voltage Output Mode | | | | | | | | | | | | | | | | | | | | | | | | | | | | | | | | | | | | | | | | | | | | | | | | | | | | | |
| 0000 | 4.0 V (default) | Invalid | | | | | | | | | | | | | | | | | | | | | | | | | | | | | | | | | | | | | | | | | | | | | | | | | | | | | |
| 0001 | 5.0 V | Invalid | | | | | | | | | | | | | | | | | | | | | | | | | | | | | | | | | | | | | | | | | | | | | | | | | | | | | |
| 0010 | 6.0 V | Invalid | | | | | | | | | | | | | | | | | | | | | | | | | | | | | | | | | | | | | | | | | | | | | | | | | | | | | |
| 0011 | 9.0 V | 9.0 V | | | | | | | | | | | | | | | | | | | | | | | | | | | | | | | | | | | | | | | | | | | | | | | | | | | | | |
| 0100 | 11.0 V | Invalid | | | | | | | | | | | | | | | | | | | | | | | | | | | | | | | | | | | | | | | | | | | | | | | | | | | | | |
| 0101 | 12.0 V | Invalid | | | | | | | | | | | | | | | | | | | | | | | | | | | | | | | | | | | | | | | | | | | | | | | | | | | | | |
| 0110 | 13.0 V | Invalid | | | | | | | | | | | | | | | | | | | | | | | | | | | | | | | | | | | | | | | | | | | | | | | | | | | | | |
| 0111 | 14.0 V | Invalid | | | | | | | | | | | | | | | | | | | | | | | | | | | | | | | | | | | | | | | | | | | | | | | | | | | | | |
| 1000 | 15.0 V | 15.0 V | | | | | | | | | | | | | | | | | | | | | | | | | | | | | | | | | | | | | | | | | | | | | | | | | | | | | |
| 1001 | 18.0 V | 18.0 V | | | | | | | | | | | | | | | | | | | | | | | | | | | | | | | | | | | | | | | | | | | | | | | | | | | | | |
| 1010 | 20.0 V | Invalid | | | | | | | | | | | | | | | | | | | | | | | | | | | | | | | | | | | | | | | | | | | | | | | | | | | | | |
| 1011 | 23.0 V | Invalid | | | | | | | | | | | | | | | | | | | | | | | | | | | | | | | | | | | | | | | | | | | | | | | | | | | | | |
| 1100 | 25.0 V | Invalid | | | | | | | | | | | | | | | | | | | | | | | | | | | | | | | | | | | | | | | | | | | | | | | | | | | | | |
| 1101 | 27.0 V | Invalid | | | | | | | | | | | | | | | | | | | | | | | | | | | | | | | | | | | | | | | | | | | | | | | | | | | | | |
| 1110 | 30.0 V | Invalid | | | | | | | | | | | | | | | | | | | | | | | | | | | | | | | | | | | | | | | | | | | | | | | | | | | | | |
| 1111 | 32.0 V | Invalid | | | | | | | | | | | | | | | | | | | | | | | | | | | | | | | | | | | | | | | | | | | | | | | | | | | | | |

表 15. Configuration Buck-Boost Register Field Descriptions (continued)

| Bit | Field | Type | Reset | Description | | |
|-----|-------------|------|-------|--|---------------------|-------------------|
| 5:2 | NCLMP[3:0] | R/W | 0000 | Buck-Boost converter negative clamp setting, DAC output unloaded - Buck-Boost converter negative arm low side clamp | | |
| | | | | Current Output Mode | Voltage Output Mode | |
| | | | | 0000 | -5.0 V | Invalid |
| | | | | 0001 | -6.0 V | Invalid |
| | | | | 0010 | -9.0 V | -9.0 V |
| | | | | 0011 | -11.0 V | Invalid |
| | | | | 0100 | -12.0 V | Invalid |
| | | | | 0101 | -13.0 V | Invalid |
| | | | | 0110 | -14.0 V | Invalid |
| | | | | 0111 | -15.0 V | -15.0 V (default) |
| | | | | 1000 | -18.0 V | Invalid |
| | | | | 1001 | -18.0 V | -18.0 V |
| | | | | 101x | Invalid | Invalid |
| | | | | 11xx | Invalid | Invalid |
| 1:0 | PNSSEL[1:0] | R/W | 00 | Enable Buck-Boost converter positive and negative arm 00 - Buck-Boost converter positive and negative arm disabled (default) 01 - Buck-Boost converter positive arm enabled and negative arm disabled 10 - Buck-Boost converter positive arm disabled and negative arm enabled 11 - Buck-Boost converter positive arm and negative arm enabled | | |

8.5.2.9 DAC Channel Calibration Enable Register (address = 0x08) [reset = 0x0000]

图 116. DAC Channel Calibration Enable Register

| | | | | | | | |
|----------|----|----|----|----|----|---|------|
| 15 | 14 | 13 | 12 | 11 | 10 | 9 | 8 |
| Reserved | | | | | | | |
| R/W | | | | | | | |
| 7 | 6 | 5 | 4 | 3 | 2 | 1 | 0 |
| Reserved | | | | | | | CLEN |
| R/W | | | | | | | R/W |

LEGEND: R/W = Read/Write; R = Read only; -n = value after reset

表 16. DAC Channel Calibration Enable Register Field Descriptions

| Bit | Field | Type | Reset | Description |
|------|----------|------|----------------------|---|
| 15:1 | Reserved | R/W | 00000000 00000000 | Reserved |
| 0 | CLEN | R/W | 0 | Enable DAC calibration - When set, this bit enables DAC data calibration, disabled by default |

8.5.2.10 DAC Channel Gain Calibration Register (address = 0x09) [reset = 0x0000]

图 117. DAC Channel Gain Calibration Register

| | | | | | | | |
|-------------|----|----|----|----|----|---|---|
| 15 | 14 | 13 | 12 | 11 | 10 | 9 | 8 |
| UGAIN[15:8] | | | | | | | |
| R/W | | | | | | | |
| 7 | 6 | 5 | 4 | 3 | 2 | 1 | 0 |
| UGAIN[7:0] | | | | | | | |

| |
|-----|
| R/W |
|-----|

LEGEND: R/W = Read/Write; R = Read only; -n = value after reset

表 17. DAC Channel Gain Calibration Register Field Descriptions

| Bit | Field | Type | Reset | Description |
|------|-------------|------|----------------------|-----------------------|
| 15:0 | UGAIN[15:0] | R/W | 00000000 00000000 | 16-bit user gain data |

8.5.2.11 DAC Channel Offset Calibration Register (address = 0x0A) [reset = 0x0000]

☒ 118. DAC Channel Offset Calibration Register

| | | | | | | | |
|------------|----|----|----|----|----|---|---|
| 15 | 14 | 13 | 12 | 11 | 10 | 9 | 8 |
| UOFF[15:8] | | | | | | | |
| R/W | | | | | | | |
| 7 | 6 | 5 | 4 | 3 | 2 | 1 | 0 |
| UOFF[7:0] | | | | | | | |
| R/W | | | | | | | |

LEGEND: R/W = Read/Write; R = Read only; -n = value after reset

表 18. DAC Channel Offset Calibration Register Field Descriptions

| Bit | Field | Type | Reset | Description |
|------|------------|------|----------------------|-------------------------|
| 15:0 | UOFF[15:0] | R/W | 00000000 00000000 | 16-bit user offset data |

8.5.2.12 Status Register (address = 0x0B) [reset = 0x1000]

☒ 119. Status Register

| | | | | | | | |
|----------|------|-----|------|-----|-----|-----|-----|
| 15 | 14 | 13 | 12 | 11 | 10 | 9 | 8 |
| Reserved | | | CLST | WDT | PGF | PGC | PGB |
| R/W | | | R/W | R/W | R/W | R/W | R/W |
| 7 | 6 | 5 | 4 | 3 | 2 | 1 | 0 |
| PGA | UTGL | CRE | TMP | FD | FC | FB | FA |
| R/W | R/W | R/W | R/W | R/W | R/W | R/W | R/W |

LEGEND: R/W = Read/Write; R = Read only; -n = value after reset

表 19. Status Register Field Descriptions

| Bit | Field | Type | Reset | Description |
|-------|----------|------|-------|--|
| 15:13 | Reserved | R/W | 000 | Reserved |
| 12 | CLST | R/W | 1 | Auto Learn status - Indicates that Auto Learn operation is finished |
| 11 | WDT | R/W | 0 | Watchdog timer fault - Indicates that watchdog timer fault has occurred |
| 10 | PGF | R/W | 0 | Buck-Boost D power good - Indicates the power good condition on Buck-Boost converter D |
| 9 | PGC | R/W | 0 | Buck-Boost C power good - Indicates the power good condition on Buck-Boost converter C |
| 8 | PGB | R/W | 0 | Buck-Boost B power good - Indicates the power good condition on Buck-Boost converter B |
| 7 | PGA | R/W | 0 | Buck-Boost A power good - Indicates the power good condition on Buck-Boost converter A |
| 6 | UTGL | R/W | 0 | User toggle - Copy of user bit (UBT) |
| 5 | CRE | R/W | 0 | CRC error - Indicates CRC error condition |
| 4 | TMP | R/W | 0 | Over temperature - Indicates over temperature condition |

表 19. Status Register Field Descriptions (continued)

| Bit | Field | Type | Reset | Description |
|-----|-------|------|-------|---|
| 3 | FD | R/W | 0 | Fault channel D - Indicates fault condition channel D |
| 2 | FC | R/W | 0 | Fault channel C - Indicates fault condition channel C |
| 1 | FB | R/W | 0 | Fault channel B - Indicates fault condition channel B |
| 0 | FA | R/W | 0 | Fault channel A - Indicates fault condition channel A |

8.5.2.13 Status Mask Register (address = 0x0C) [reset = 0x0000]

图 120. Status Mask Register

| | | | | | | | | |
|----------|----|------|------|-----|----------|-----|-----|--|
| 15 | 14 | 13 | 12 | 11 | 10 | 9 | 8 | |
| Reserved | | | | MWT | Reserved | | | |
| R/W | | | | R/W | R/W | | | |
| 7 | 6 | 5 | 4 | 3 | 2 | 1 | 0 | |
| Reserved | | MCRE | MTMP | MFD | MFC | MFB | MFA | |
| R/W | | R/W | R/W | R/W | R/W | R/W | R/W | |

LEGEND: R/W = Read/Write; R = Read only; -n = value after reset

表 20. Status Mask Register Field Descriptions

| Bit | Field | Type | Reset | Description |
|-------|----------|------|-------|---|
| 15:12 | Reserved | R/W | 0000 | Reserved |
| 11 | MWT | R/W | 0 | Mask WDT - When set, it masks the alarm pin from watchdog timer fault condition |
| 10:6 | Reserved | R/W | 00000 | Reserved |
| 5 | MCRE | R/W | 0 | CRC error - When set, it masks the alarm pin from CRC error condition |
| 4 | MTMP | R/W | 0 | Mask TMP - When set, it masks the alarm pin from over temperature condition |
| 3 | MFD | R/W | 0 | Mask FD - When set, it masks the alarm pin from fault condition channel D |
| 2 | MFC | R/W | 0 | Mask FC - When set, it masks the alarm pin from fault condition channel C |
| 1 | MFB | R/W | 0 | Mask FB - When set, it masks the alarm pin from fault condition channel B |
| 0 | MFA | R/W | 0 | Mask FA - When set, it masks the alarm pin from fault condition channel A |

8.5.2.14 Alarm Action Register (address = 0x0D) [reset = 0x0000]

图 121. Alarm Action Register

| | | | | | | | |
|-----------------|----|-------------|----|-------------|----|-------------|---|
| 15 | 14 | 13 | 12 | 11 | 10 | 9 | 8 |
| Reserved | | | | | | | |
| R/W | | | | | | | |
| 7 | 6 | 5 | 4 | 3 | 2 | 1 | 0 |
| AC_CRE_WDT[1:0] | | AC_IOC[1:0] | | AC_VSC[1:0] | | AC_TMP[1:0] | |
| R/W | | R/W | | R/W | | R/W | |

LEGEND: R/W = Read/Write; R = Read only; -n = value after reset

表 21. Alarm Action Register Field Descriptions

| Bit | Field | Type | Reset | Description |
|------|-----------------|------|----------|--|
| 15:8 | Reserved | R/W | 00000000 | Reserved |
| 7:6 | AC_CRE_WDT[1:0] | R/W | 00 | Action CRC error and Watchdog timer fault circuit condition 00 - No action on Buck-Boost converters, no action on DACs (default) 01 - No action on Buck-Boost converters, respective user alarm code on all DACs 10 - All Buck-Boost converters and DACs disabled and remain disabled even after the alarm condition is removed. 11 - Invalid |
| 5:4 | AC_IOC[1:0] | R/W | 00 | Action current output open circuit condition 00 - No action on Buck-Boost converters, no action on DACs (default) 01 - No action on Buck-Boost converters, respective user alarm code on DAC(s) initiating the alarm 10 - All Buck-Boost converters and DACs disabled and remain disabled even after the alarm condition is removed. 11 - Invalid |
| 3:2 | AC_VSC[1:0] | R/W | 00 | Action voltage output short circuit condition 00 - No action on Buck-Boost converters, no action on DACs (default) 01 - No action on Buck-Boost converters, respective user alarm code on DAC(s) initiating the alarm 10 - All Buck-Boost converters and DACs disabled and remain disabled even after the alarm condition is removed. 11 - Invalid |
| 1:0 | AC_TMP[1:0] | R/W | 00 | Action over temperature condition 00 - No action on Buck-Boost converters, no action on DACs (default) 01 - No action on Buck-Boost converters, respective user alarm code on all DACs 10 - All Buck-Boost converters and DACs disabled and remain disabled even after the alarm condition is removed. 11 - Invalid |

8.5.2.15 User Alarm Code Register (address = 0x0E) [reset = 0x0000]
☒ 122. User Alarm Code Register

| | | | | | | | |
|--------------|----|----|----|----|----|--------|-----|
| 15 | 14 | 13 | 12 | 11 | 10 | 9 | 8 |
| ACODE[15:10] | | | | | | HSCLMP | 0 |
| R/W | | | | | | R/W | R/W |
| 7 | 6 | 5 | 4 | 3 | 2 | 1 | 0 |
| Reserved | | | | | | | |
| R/W | | | | | | | |

LEGEND: R/W = Read/Write; R = Read only; -n = value after reset

表 22. User Alarm Code Register Field Descriptions

| Bit | Field | Type | Reset | Description |
|-------|--------------|------|----------|--|
| 15:10 | ACODE[15:10] | R/W | 000000 | 6 bit alarm code data |
| 9 | HSCLMP | R/W | 0 | Buck-Boost positive output high side clamp 0 - Buck-Boost converter positive output high side clamp set to 32 V (default) 1 - Buck-Boost converter positive output high side clamp set to 26 V (default) |
| 8 | 0 | R/W | 0 | 0 |
| 7:0 | Reserved | R/W | 00000000 | Reserved |

8.5.2.16 Reserved Register (address = 0x0F) [reset = N/A]
图 123. Reserved Register

| | | | | | | | |
|----------|----|----|----|----|----|---|---|
| 15 | 14 | 13 | 12 | 11 | 10 | 9 | 8 |
| Reserved | | | | | | | |
| 7 | 6 | 5 | 4 | 3 | 2 | 1 | 0 |
| Reserved | | | | | | | |

LEGEND: R/W = Read/Write; R = Read only; -n = value after reset

表 23. Reserved Register Field Descriptions

| Bit | Field | Type | Reset | Description |
|------|----------|------|-------|-------------|
| 15:0 | Reserved | – | N/A | Reserved |

8.5.2.17 Write Watchdog Timer Register (address = 0x10) [reset = 0x0000]
图 124. Write Watchdog Timer Register

| | | | | | | | |
|----------|----|----|----|----|----|---|-----|
| 15 | 14 | 13 | 12 | 11 | 10 | 9 | 8 |
| Reserved | | | | | | | |
| W | | | | | | | |
| 7 | 6 | 5 | 4 | 3 | 2 | 1 | 0 |
| Reserved | | | | | | | RWD |
| W | | | | | | | W |

LEGEND: R/W = Read/Write; R = Read only; W = Write only; -n = value after reset

表 24. Write Watchdog Timer Register Field Descriptions

| Bit | Field | Type | Reset | Description |
|------|----------|------|----------------------|--|
| 15:1 | Reserved | – | 00000000 00000000 | Reserved |
| 0 | RWD | W | 0 | Reset watchdog timer, this bit clears itself after resetting watch dog timer |

8.5.2.18 Device ID Register (address = 0x11) [reset = 0x0000]
图 125. Device ID Register

| | | | | | | | |
|----------|----|----|----|----|----|----------|---|
| 15 | 14 | 13 | 12 | 11 | 10 | 9 | 8 |
| Reserved | | | | | | | |
| R | | | | | | | |
| 7 | 6 | 5 | 4 | 3 | 2 | 1 | 0 |
| Reserved | | | | | | DID[2:0] | |
| R | | | | | | R | |

LEGEND: R/W = Read/Write; R = Read only; -n = value after reset

表 25. Device ID Register Field Descriptions

| Bit | Field | Type | Reset | Description |
|------|-----------|------|--------------------|----------------------------------|
| 15:3 | Reserved | – | 00000000 000000 | Reserved |
| 2:0 | DID [2:0] | R | 000 | 3-bit device identification code |

8.5.2.19 Reserved Register (address 0x12 - 0xFF) [reset = N/A]
☒ 126. Reserved Register

| | | | | | | | |
|----------|----|----|----|----|----|---|---|
| 15 | 14 | 13 | 12 | 11 | 10 | 9 | 8 |
| Reserved | | | | | | | |
| 7 | 6 | 5 | 4 | 3 | 2 | 1 | 0 |
| Reserved | | | | | | | |

LEGEND: R/W = Read/Write; R = Read only; -n = value after reset

表 26. Reserved Register Field Descriptions

| Bit | Field | Type | Reset | Description |
|------|----------|------|-------|-------------|
| 15:0 | Reserved | – | N/A | Reserved |

9 Application and Implementation

注

Information in the following applications sections is not part of the TI component specification, and TI does not warrant its accuracy or completeness. TI's customers are responsible for determining suitability of components for their purposes. Customers should validate and test their design implementation to confirm system functionality.

9.1 Application Information

9.1.1 Buck-Boost Converter External Component Selection

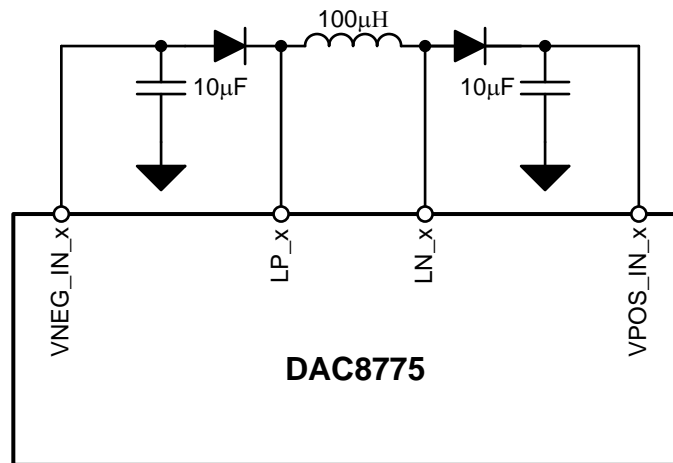

Copyright © 2016, Texas Instruments Incorporated

图 127. DAC8775 External Buck-Boost Components with Recommended Values

The buck-boost converters integrated in the DAC8775 each require three external passive components for operation: a single inductor per channel as well as storage capacitors and switching diodes for each VPOS_IN_x and VNEG_IN_x channels that are active. If only one output is used, either VPOS_IN_x or VNEG_IN_x, the inactive output components may be removed and the respective inputs tied to ground. In order to meet the parametric performance outlined in the [Electrical Characteristics](#) section for the voltage output, 500 mV of foot-room is required on VNEG_IN_x.

The recommended value for the external inductor is 100 µH with at least 500 mA peak inductor current. Reducing the inductor value to as low as 80 µH is possible, though this will limit the buck-boost converter maximum input voltage to output voltage ratio, reduce efficiency, and increase ripple. Reducing the inductor below 80 µH will result in device damage. Peak inductor current should be rated at 500 mA or greater with 20% inductance tolerance at peak current. If peak inductor current for an inductor is violated the effective inductance is reduced, which will impact maximum input to output voltage ratio, efficiency, and ripple.

An output, or storage, X7R capacitor with value of 10 µF and voltage rating of 50 V is recommended though other values and dielectric materials may be used without damaging the DAC8775. Reducing capacitor value will increase buck-boost converter output ripple and reduced voltage rating will reduce effective capacitance at full-scale buck-boost converter outputs. X7R capacitors are rated for –55°C to 125°C operation with 15% maximum capacitance variance over temperature. Designs operating over reduced temperature spans and with loose efficiency requirements may use different dielectric material. C0G capacitor typically offer tighter capacitance variance but come in larger packages, but may be beneficial substitutes.

Application Information (continued)

The external diode switches illustrated on the left and right side of the 100 μH inductor shown in [Figure 127](#) should be selected based on reverse voltage rating, reverse recovery time, leakage or parasitic capacitance, and current or power ratings. Breakdown voltage rating of at least 60 V is recommended to accommodate for the maximum voltage that may be across the diode when both V_{POS_x} and V_{NEG_x} are both active during switching of the DC/DCs. Minimal reverse recovery time and parasitic capacitance is recommended in order to preserve efficiency of the DC/DCs. The external diode should be rated for at least 500 mA average forward current.

9.1.2 Voltage and Current Outputs on a Shared Terminal

[Figure 128](#) illustrates a simplified block diagram of the voltage output stages of the DAC8775.

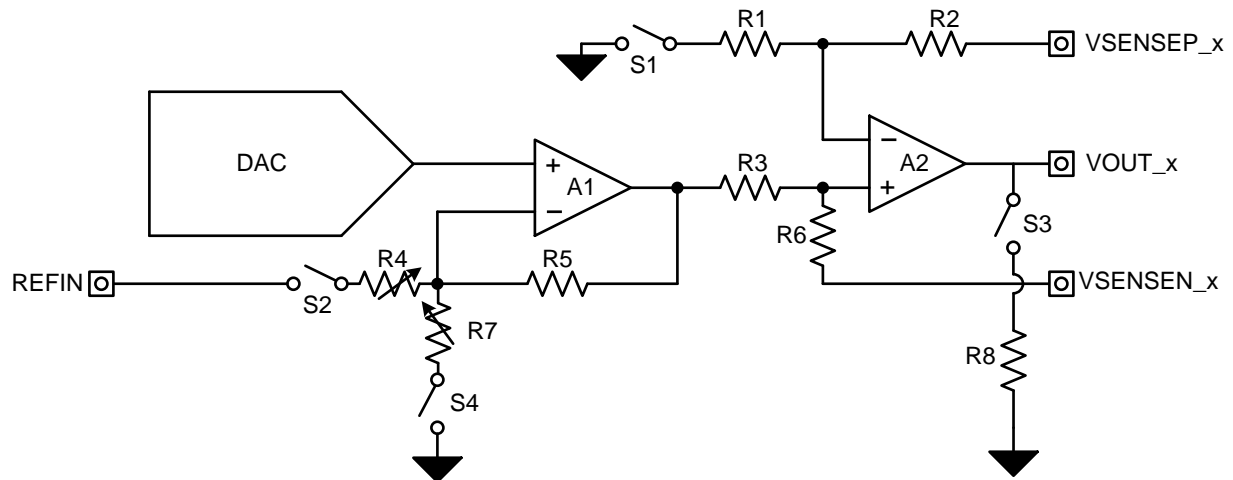

Copyright © 2016, Texas Instruments Incorporated

Figure 128. Simplified Block Diagram of Voltage Output Architecture

When designing for a shared voltage and current output terminal it is important to consider leakage paths that may corrupt the voltage or current output stages.

When the voltage output is active and the current output is inactive the I_{OUT_x} pin becomes a high-impedance node and therefore does not significantly load the voltage output in a way that would degrade V_{OUT_x} performance. When the voltage output is inactive and the current output is active switches S1, S2, and S4 all become open while switch S3 is controlled by the POC bit in the Reset Config Register for each respective channel. When the POC bit is set to a 0, the default value, switch S3 is closed when V_{OUT} is disabled. This creates a leakage path with respect to the current output when the terminals are shared which will create a load-dependent error. In order to reduce this error the POC bit can be set to a 1 which opens switch S3, effectively making the V_{OUT} pin high-impedance and reducing the magnitude of leakage current.

9.1.3 Optimizing Current Output Settling time with Auto learn Mode

When the buck-boost converters are active power and heat dissipation of the device are at a minimum, however settling time of the current output is dominated by the slew rate of the buck-boost converter, which is significantly slower than the current output signal chain alone. When the buck-boost converters are bypassed settling time of the current output is minimized while power and heat dissipation are significant.

Auto-learn mode offers an alternative mode which allows the buck-boost converter to learn the size of the load and choose a clamped output value that does not change over the full range of the selected current output. This allows a balance between settling time and power dissipation. There are two options for entering auto-learn mode:

- Enable the buck-boost converter in full-tracking mode followed by enabling the current output. Until the DAC code 0x4000 is passed, settling time will be dominated by the buck-boost converter. After code 0x400 is surpassed the buck-boost converter detects the load and sets the clamp value appropriately.
- Enable the buck-boost converter in clamp-mode with clamp value set to a greater voltage than required by the largest load the current output will be expected to drive, followed by enabling the current output. Enter full-

Application Information (continued)

tracking mode. In this case the clamp value of maintained without the buck-boost converter output changing, therefore settling time is set by the IOUT_x signal chain. After code 0x4000 is surpassed the buck-boost converter detects the load and adjusts the clamp value appropriately. At all times using this initialization procedure the settling time is defined by the IOUT_x signal chain.

9.1.4 Protection for Industrial Transients

In order to successfully protect the DAC8775, or any integrated circuit, against industrial transient testing the internal structures and how they may behave when exposed to said signals must be understood. [129](#) depicts a simplified representation of internal structures present on the device's output pins which are represented as a pair of clamp-to-rail diodes connected to the VPOS_IN_x and VNEG_IN_x supply rails.

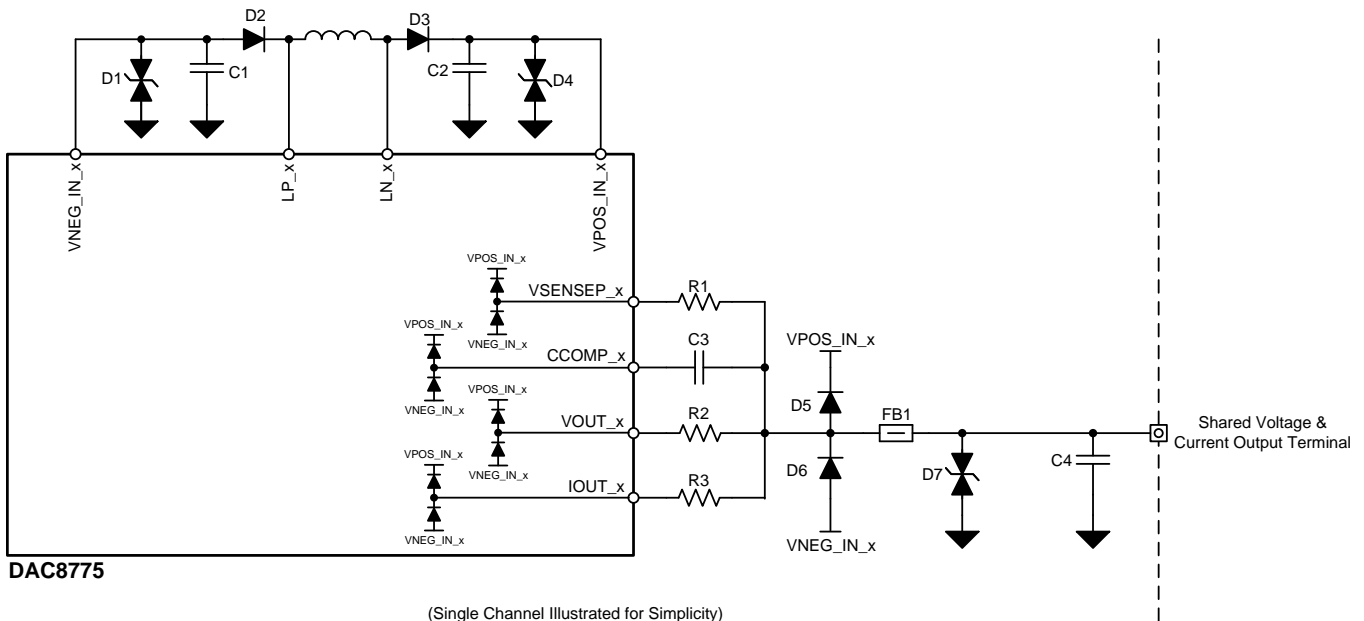

Copyright © 2016, Texas Instruments Incorporated

129. Simplified Block Diagram of Internal Structures and External Protection

When these internal structures are exposed to industrial transient testing, without the external protection components, the diode structures will become forward biased and conduct current. If the conducted current is too large, which is often true for high-voltage industrial transient tests, the structures will become permanently damaged and impact device functionality.

Both attenuation and diversion strategies are implemented to protect the internal structures as well as the device itself. Attenuation is realized by capacitor C4 which forms an R/C low-pass filter when interacting with the source impedance of the transient generator, ferrite bead FB1 also helps attenuate high-frequency current, along with both AC and DC current limiters realized by series pass elements R1, R2, and R3. Diversion is achieved by transient voltage suppressor (TVS) diode D7 and clamp-to-rail diodes D5 and D6. The combined effects of both strategies effectively limit the current flowing into the device and through the internal diode structures such that the device is not damaged and remains functional.

It is important to also include TVS diodes D1 and D4 at the VPOS_IN_x and VNEG_IN_x nodes in order to provide a discharge path for the energy that is going to be sent to these nodes through diodes D5, D6, and the internal diode structures. Without these diodes when current is diverted to these nodes the DC/DC converter storage capacitors C1 and C2 will charge, slowly increasing the voltage at these nodes.

Application Information (continued)

9.1.5 Implementing HART with DAC8775

The DAC8775 features internal resistors to convert a 500-mVpp HART FSK signal sourced by an external HART modem. These resistors are ratiometrically matched to the gain-setting resistors for the current output signal chain to ensure that a 500-mVpp input at the HART_IN_x pin is delivered as a 1-mAapp signal at the respective IOUT_x pin regardless of which gain mode is selected.

An external capacitor, placed in series between the HART_IN_x pin and HART FSK source, is required to AC couple the HART FSK signal to the HART_IN_x pin. The recommended capacitance for this external capacitor is from 10 nF to 22 nF.

9.2 Typical Application

9.2.1 1W Power Dissipation, Quad Channel, EMC and EMI Protected Analog Output Module with Adaptive Power Management

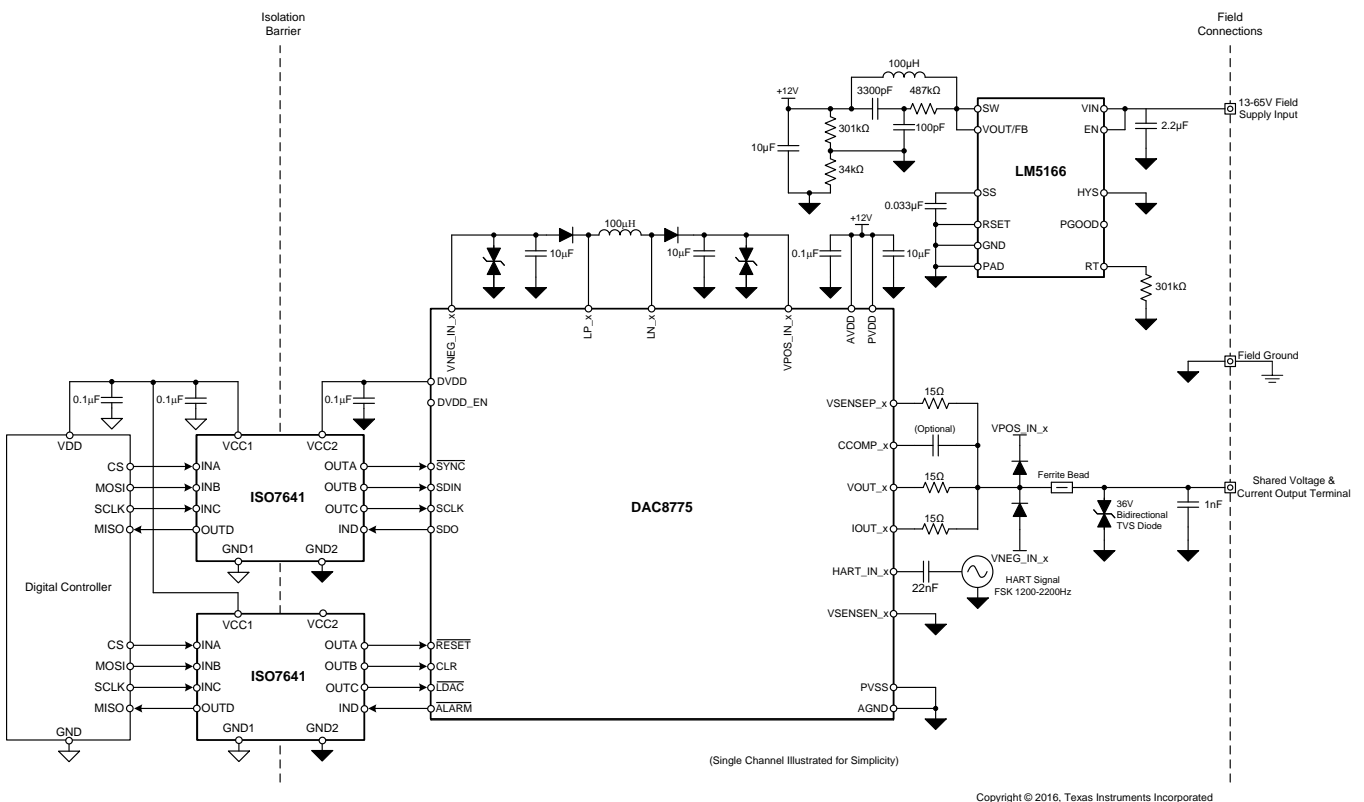

130. DAC8775 in Quad-Channel PLC AO Module

9.2.2 Design Requirements

Analog I/O modules are used by programmable logic controllers (PLCs) to interface sensors, actuators, and other field instruments. These modules must meet stringent electrical specifications for both accuracy and robust protection. These outputs are typically current outputs based on the 4-mA to 20-mA range and derivatives or voltage outputs ranging from 0 V to 5 V, 0 V to 10 V, ±5 V, and ±10 V. Common error budgets accommodate 0.1% full-scale range total unadjusted error (% FSR TUE) at room temperature. Designs that desire stronger accuracy over temperature frequently implement calibration. Often the PLC back-plane provides access to a 12-V to 36-V analog supply from which a majority of analog supply voltages are derived.

Typical Application (continued)

Analog output modules are frequently multi-channel modules featuring either channel-to-channel isolation between each channel or group isolation where several channels share a common ground connection. As channel count increases it is desirable to maintain small form-factor requiring high levels of integration and reduced power dissipation in order to control heat inside of the PLC enclosure.

Therefore the design requirements are:

- Support of standard industrial automation voltage and current output spans
- Operation with standard industrial automation supply voltages from 12 V to 36 V
- Current and voltage outputs with TUE less than 0.1% at 25°C
- Total on-board power dissipation less than or equal to 1 W
- At minimum criteria B IEC61000-4 ESD, EFT, CI, and Surge immunity

9.2.3 Detailed Design Procedure

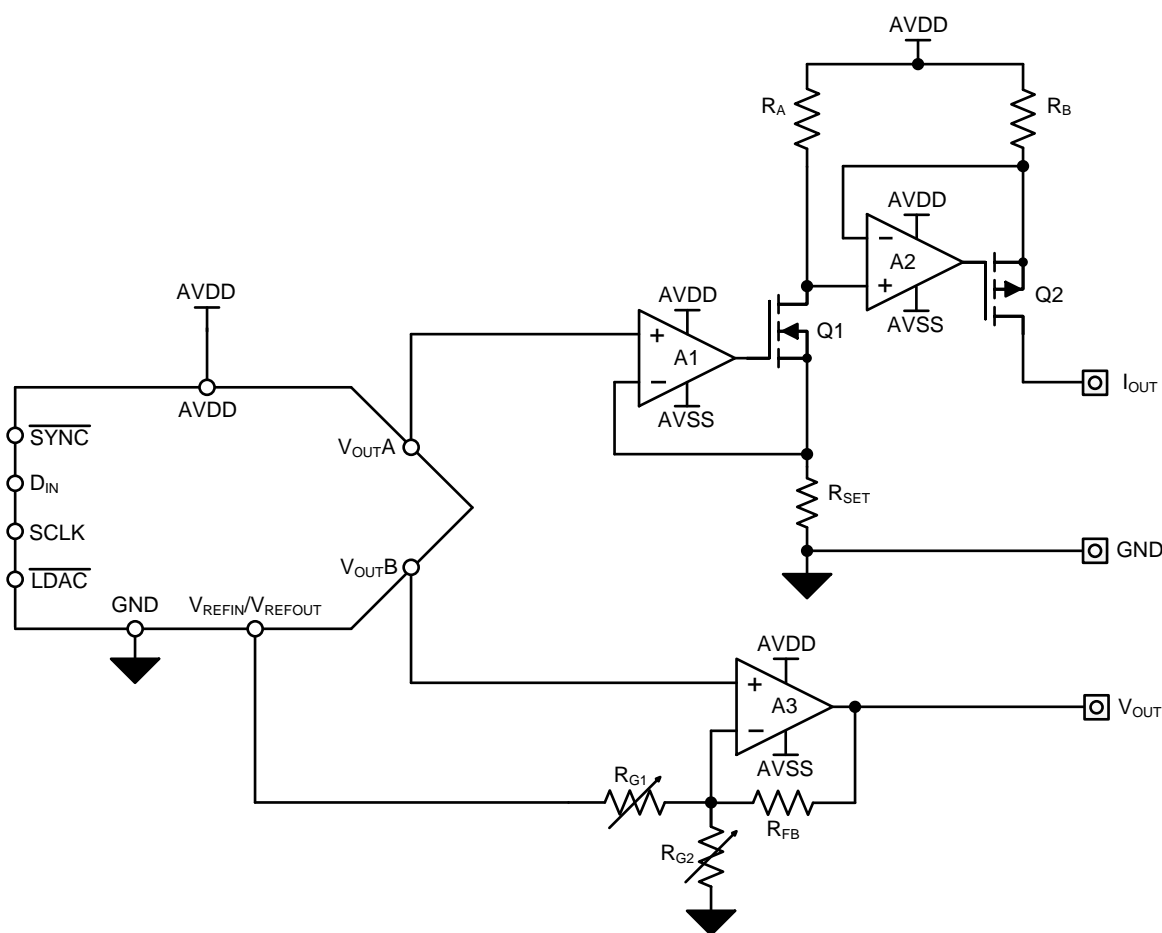

Copyright © 2016, Texas Instruments Incorporated

✶ 131. Generic Design for Typical PLC Current and Voltage Outputs

✶ 131 illustrates a common generic solution for realizing the desired voltage and current output spans for industrial automation applications.

The current output circuit is comprised of amplifiers A1 and A2, MOSFETs Q1 and Q2, and the three resistors RSET, RA, and RB. This two-stage current source enables the ground-referenced DAC output voltage to drive the high-side amplifier required for the current-source.

Typical Application (continued)

The voltage output circuit is composed of amplifier A3 and the resistor network consisting of RFB, RG1, and RG2. A3 operates as a modified summing amplifier, where the DAC controls the non-inverting input and inverting input has one path to GND and a second to VREF. This configuration allows the single-ended DAC to create both the unipolar 0-V to 5-V and 0-V to 10-V outputs and the bipolar ± 5 -V and ± 10 -V outputs by modifying the values of RG1 and RG2.

Though this generic circuit realizes the desired spans, both the voltage and current outputs have short-comings. The current output high-side supply voltage is typically 24 V, when driving low impedance loads with this supply voltage a considerable amount of power is dissipated on RB and Q2. This power dissipation results in increased heat which leads to drift errors for amplifiers A1 and A2 as well as the DAC, resistors, and the reference voltage. In order to reduce the power dissipation in the high-side voltage to current converter circuit a feedback system which monitors the voltage drop across Q2 and adaptively adjusts the high-side supply voltage can be implemented. This feedback system adjusts the high side supply voltage to the minimum supply required to keep Q2 in the linear region of operation, avoiding compliance voltage saturation, reducing power dissipation and heat to a minimum which helps maintain accuracy.

The generic voltage output circuit performs well but does not compensate for errors associated with excessive output impedance or differences in ground potential from the local PLC ground and the load ground. A modified circuit can be implemented which provides connections to sense errors associated with both output impedance voltage drops and differences in ground potentials, this circuit is shown in [128](#).

[130](#) illustrates the DAC8775 along with the LM5166 in a quad-channel PLC analog output module. The DAC8775 includes the generic voltage and current output circuits along with buck-boost converter and feedback circuits for the current output and positive and negative sense connections for the voltage output circuit. The DAC8775 includes an internal reference and internal LDO for supplying the field-side of a digital isolator along with the buck-boost converter generating the single or dual high voltage supplies required for the output circuits, all powered from a single supply.

The DAC8775 buck-boost converter operates at peak efficiency with 12-V input voltage with peak power consumption of approximately 780mW. The LM5166 circuit accepts a wide range of input voltages from just above 12 V to 65 V, providing coverage for most standard PLC supply voltages, and buck-converts this supply voltage to the optimal 12-V supply for the DAC8775. Cumulative power dissipation for the DAC8775 and LM5166 is under 1 W.

Two ISO7641 devices implement galvanic isolation for all of the digital communication lines, though only a single ISO7641 is required for basic communication with the DAC8775 SPI compatible interface. An output protection circuit is included which is designed to provide immunity to the IEC61000-4 industrial transient and radiation test suite. The protection circuit includes transient voltage suppressor (TVS) diodes, clamp-to-rail steering diodes, and pass elements in the form of resistors and ferrite beads.

9.2.4 Application Curves

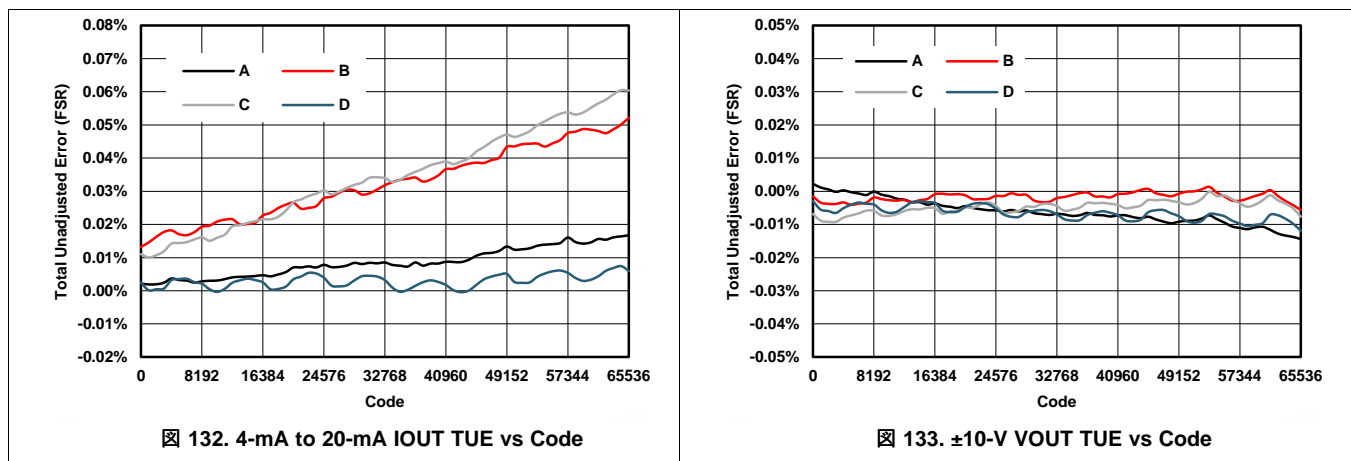

Typical Application (continued)

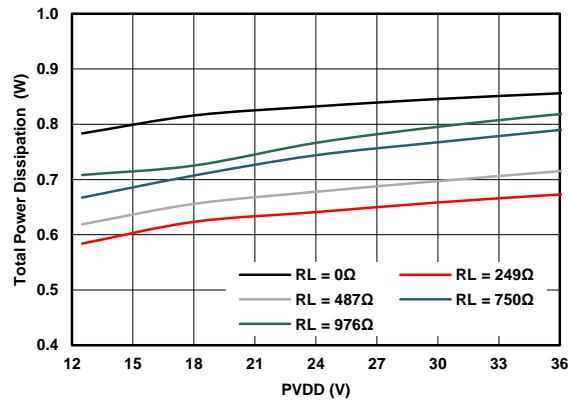

☒ 134. Total On-Board Power Dissipation vs Supply

10 Power Supply Recommendations

There are three possible hardware power supply configurations for the DAC8775: the internal DC/DC provides both positive and negative supply voltages, the internal DC/DC provides only one of the supply voltages with an external supply provided on the other, or the internal DC/DC is not used at all and external supply voltages are provided for both positive and negative supply voltages. Simple illustrations for each case are shown below.

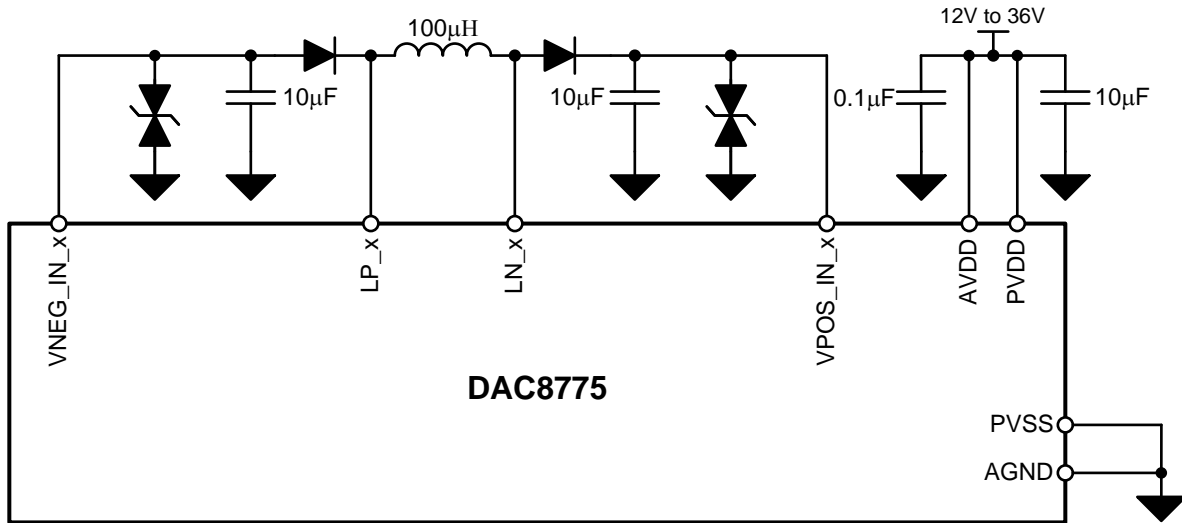

(Single Channel Illustrated for Simplicity)

Copyright © 2016, Texas Instruments Incorporated

☒ 135. DAC8775 With Dual Supplies from Internal DC/DC

☒ 136 illustrates using a single supply from the DAC8775 internal DC/DC and the other supply from an external source. In this example the VNEG_IN_x supply is the input being supplied by an external supply, or ground for unipolar output spans. A similar scheme could be used if VPOS_IN_x was supplied by an external supply and VNEG_IN_x was supplied by the internal DC/DC.

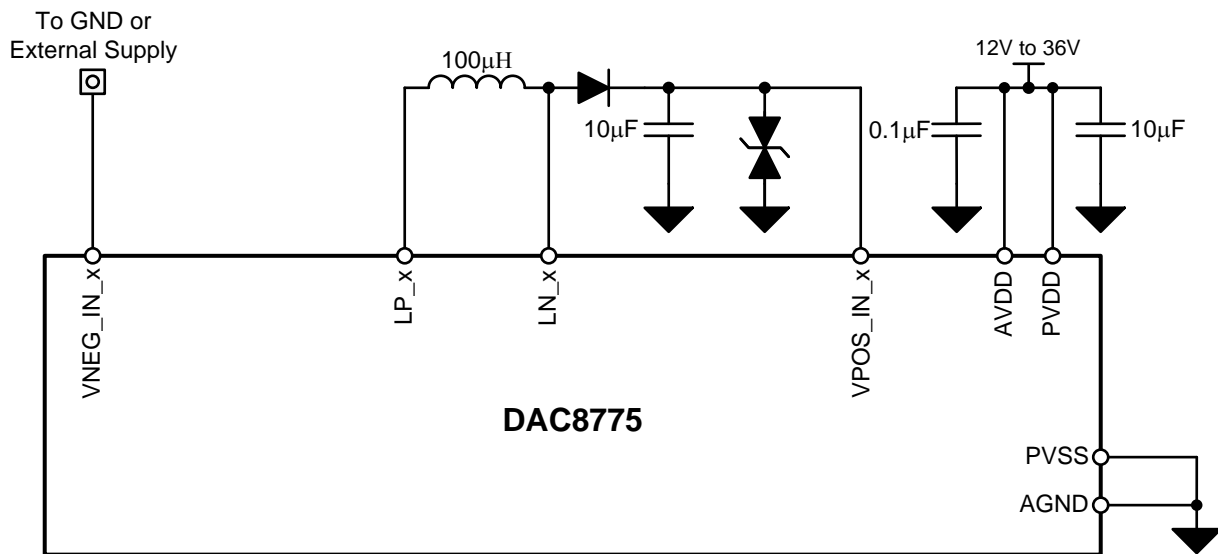

(Single Channel Illustrated for Simplicity)

Copyright © 2016, Texas Instruments Incorporated

☒ 136. DAC8775 With Single Supply from Internal DC/DC

DAC8775

JAJSCW9 – FEBRUARY 2017

www.tij.co.jp

The scheme in [☒ 137](#) should be used if the internal DC/DC is not used at all and external supplies are selected for VPOS_IN_x and VNEG_IN_x. When using external supplies for VPOS_IN_x it is important that VPOS_IN_x, PVDD, and AVDD nodes are tied to the same voltage potential with the same ramp-rate.

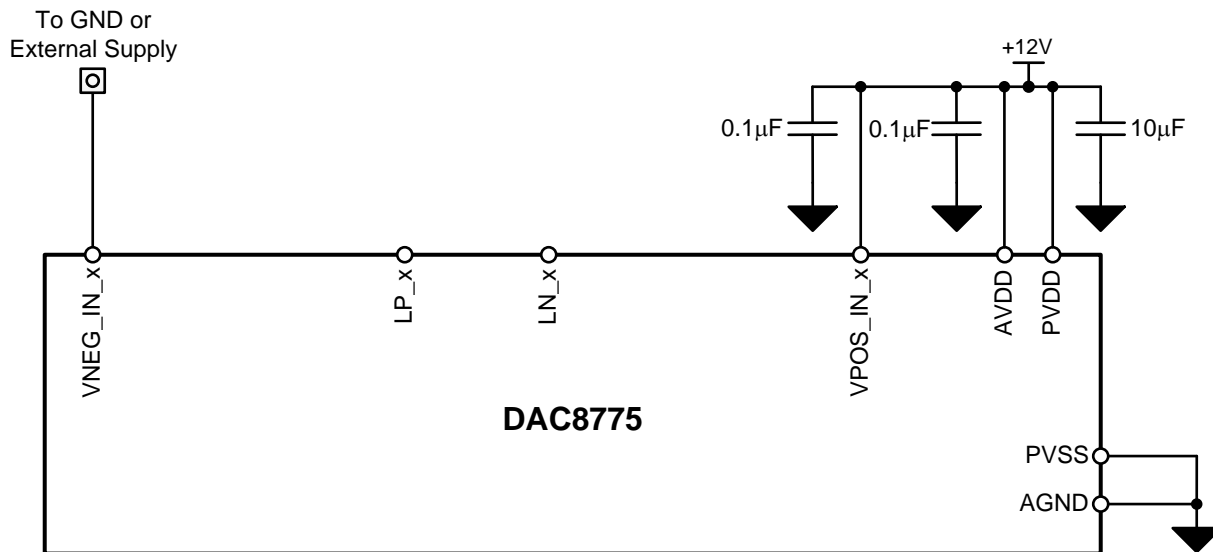

(Single Channel Illustrated for Simplicity)

Copyright © 2016, Texas Instruments Incorporated

☒ 137. DAC8775 with External Supplies

11 Layout

11.1 Layout Guidelines

An example layout based on the design discussed in the *Typical Application* section is shown in the *Layout Example* section. [Figure 139](#) shows the top-layer of the design which illustrates all component placement as no components are placed on the bottom layer. [Figure 140](#) shows two of the internal power-layers: the layer on the left contains VPOS_IN_B, VPOS_IN_C, VNEG_IN_B, and VNEG_IN_D nets while the layer on the right contains VPOS_IN_A, VPOS_IN_D, VNEG_IN_A, and VNEG_IN_C nets.

The layer stack-up for this 6-layer example layout is shown below. A 6-layer design is not required, however provides optimal conditions for ground and power-supply planes. The solid ground plane beneath the majority of the signal traces, which are placed on the top layer, allows for a clean return path for sensitive analog traces and keeps them isolated from the internal power supply nets which will exhibit ripple from the DC/DC converter.

| |
|---|
| Signal Traces and Ground Fill |
| Solid Ground Plane |
| Split Power Supply Plane for 13V to 66V Field Supply Connection and PVDD/AVDD net |
| Split VPOS_IN_B, VPOS_IN_C, VNEG_IN_B, and VNEG_IN_D net Planes |
| Split VPOS_IN_A, VPOS_IN_D, VNEG_IN_A, and VNEG_IN_C net Planes |
| Signal Traces and Ground Fill |

Figure 138. Example Layout Layer Stack-Up

Traces for the DC/DC external components should be as low impedance, low inductance, and low capacitance as possible in order to maintain optimum performance. As such wide traces should be used to minimize inductance with minimal use of vias as vias will contribute large inductance and capacitance to the trace. For this reason it is recommended that all DC/DC components placed on the top layer.

The industrial transient protection circuit should be placed as close to the output connectors as possible to ensure that the return currents from these transients have a controlled path to exit the PCB which does not impact the analog circuitry.

Split ground planes for the DC/DC, digital, and analog grounds are not required but may be helpful to isolated ground return currents from cross-talk. If split ground planes are used care should be taken to ensure that signal traces are only placed above or below the locations where their respective grounds are placed in order to mitigate unexpected return paths or coupling to the other ground planes. If a single ground plane is used it is advisable to follow similar practices implementing a star-ground where the respective return currents interact with one another minimally. The example layout uses a single ground plane, based on measured results, performs similarly to an identical version with split ground planes.

The perimeter of the board is stitched with vias in order to enhance design performance against environments which may include radiated emissions. Additional vias are placed in critical areas nearby the design in order to place ground pours in between nodes to reduce cross-talk between adjacent traces.

Standard best-practices should be applied to the remaining components, including but not limited to, placing decoupling capacitors close to their respective pins and using wide traces or copper pours where possible, particularly for power traces where high current may flow.

11.2 Layout Example

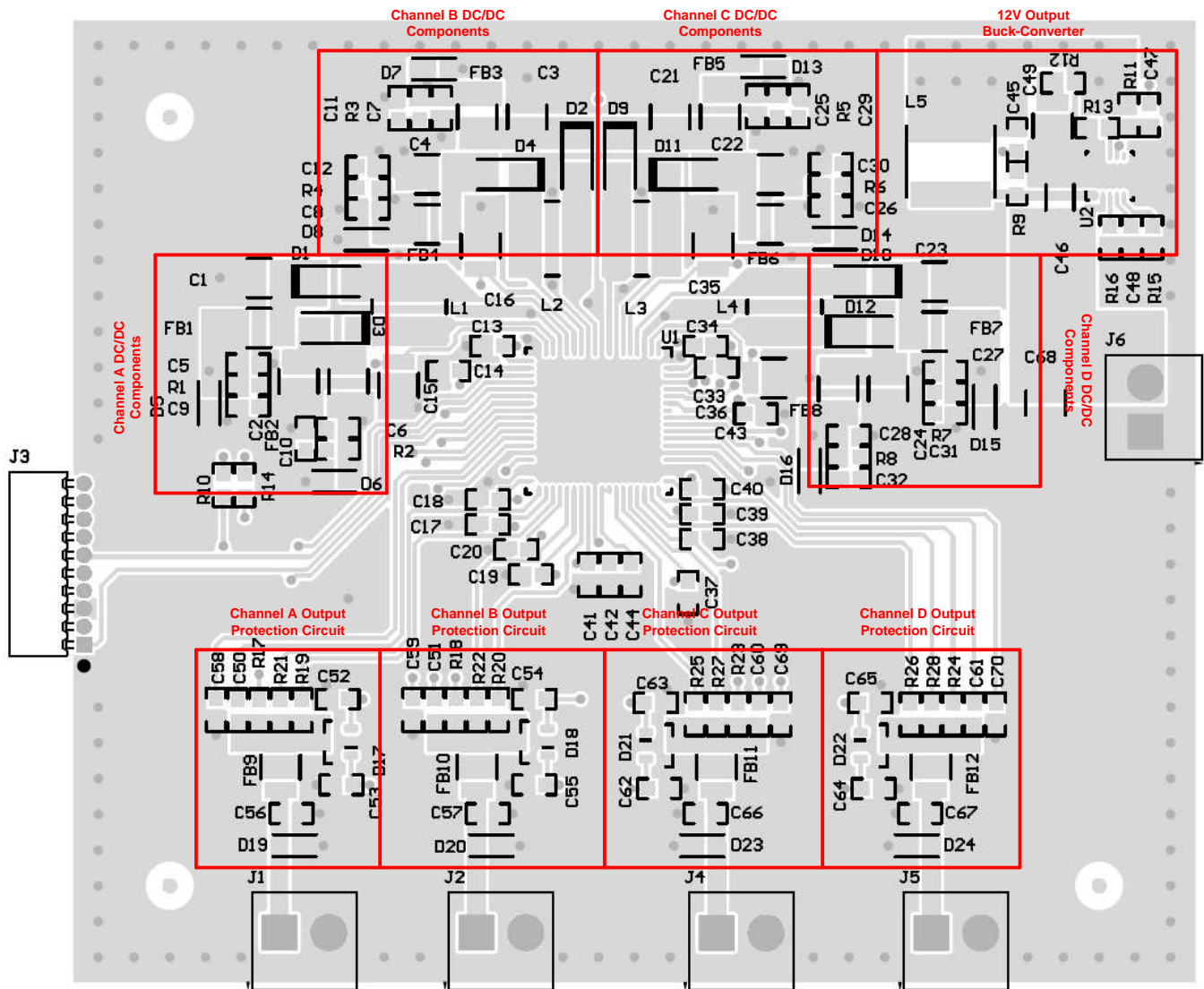
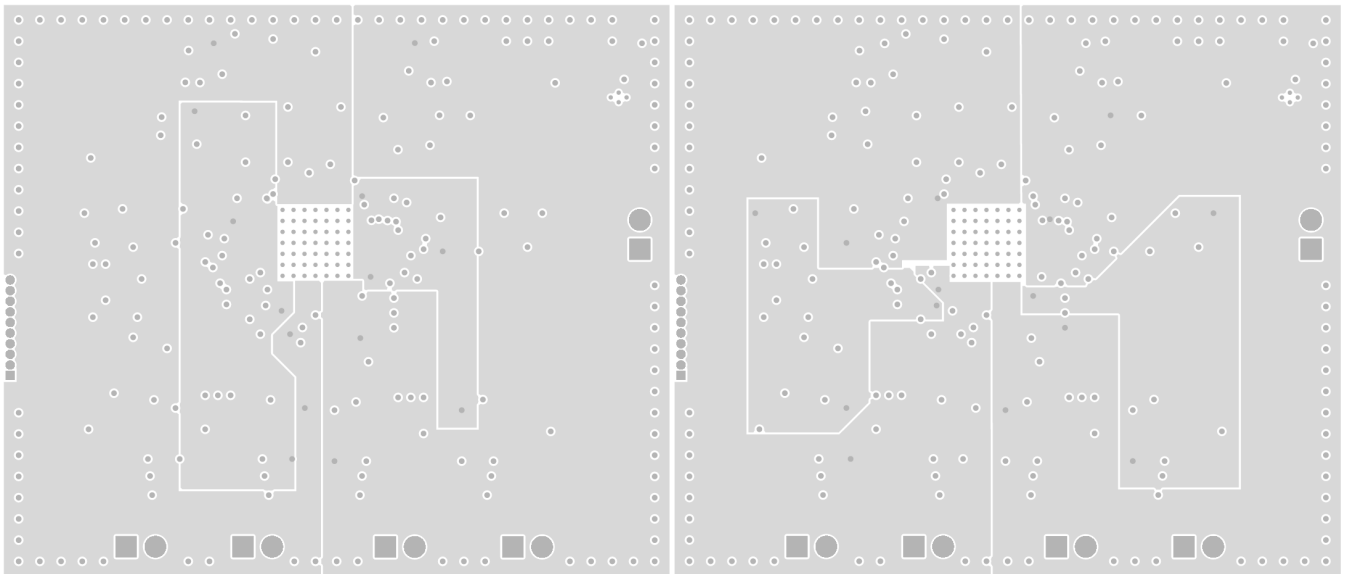

Figure 139. Application Example Layout

Layout Example (continued)



☒ 140. Example Design Internal Copper Pours

12 デバイスおよびドキュメントのサポート

12.1 ドキュメントのサポート

12.1.1 関連資料

関連資料については、以下を参照してください。

- 『DAC8775 EVMユーザー・ガイド』(SBAU248)
- LM5166 3V~65V入力、500mA、超低 I_Q の同期整流降圧コンバータ データシート(SNVSA67)
- ISO76x1 低消費電力、トリプルおよびクワッド・チャンネルのデジタル・アイソレータ(SLLSEC3)

12.2 ドキュメントの更新通知を受け取る方法

ドキュメントの更新についての通知を受け取るには、ti.comのデバイス製品フォルダを開いてください。右上の隅にある「通知を受け取る」をクリックして登録すると、変更されたすべての製品情報に関するダイジェストを毎週受け取れます。変更の詳細については、修正されたドキュメントに含まれている改訂履歴をご覧ください。

12.3 コミュニティ・リソース

The following links connect to TI community resources. Linked contents are provided "AS IS" by the respective contributors. They do not constitute TI specifications and do not necessarily reflect TI's views; see TI's [Terms of Use](#).

TI E2E™オンライン・コミュニティ *TIのE2E (Engineer-to-Engineer)* コミュニティ。エンジニア間の共同作業を促進するために開設されたものです。e2e.ti.comでは、他のエンジニアに質問し、知識を共有し、アイデアを検討して、問題解決に役立てることができます。

設計サポート *TIの設計サポート* 役に立つE2Eフォーラムや、設計サポート・ツールをすばやく見つけることができます。技術サポート用の連絡先情報も参照できます。

12.4 商標

Microwire, E2E are trademarks of Texas Instruments.

SPI, QSPI are trademarks of Motorola, Inc.

All other trademarks are the property of their respective owners.

12.5 静電気放電に関する注意事項



すべての集積回路は、適切なESD保護方法を用いて、取扱いと保存を行うようにして下さい。

静電気放電はわずかな性能の低下から完全なデバイスの故障に至るまで、様々な損傷を与えます。高精度の集積回路は、損傷に対して敏感であり、極めてわずかなパラメータの変化により、デバイスに規定された仕様に適合しなくなる場合があります。

12.6 Glossary

SLYZ022 — *TI Glossary*.

This glossary lists and explains terms, acronyms, and definitions.

13 メカニカル、パッケージ、および注文情報

以降のページには、メカニカル、パッケージ、および注文に関する情報が記載されています。この情報は、そのデバイスについて利用可能な最新のデータです。このデータは予告なく変更されることがあり、ドキュメントが改訂される場合もあります。本データシートのブラウザ版を使用されている場合は、画面左側の説明をご覧ください。

PACKAGING INFORMATION

| Orderable Device | Status (1) | Package Type | Package Drawing | Pins | Package Qty | Eco Plan (2) | Lead finish/ Ball material (6) | MSL Peak Temp (3) | Op Temp (°C) | Device Marking (4/5) | Samples |
|------------------|---------------|--------------|-----------------|------|-------------|-----------------|--------------------------------------|----------------------|--------------|-------------------------|-------------------------|
| DAC8775IRWFR | ACTIVE | VQFN | RWF | 72 | 2000 | RoHS & Green | NIPDAU | Level-3-260C-168 HR | -40 to 125 | DAC8775 | Samples |
| DAC8775IRWFT | OBSOLETE | VQFN | RWF | 72 | | TBD | Call TI | Call TI | -40 to 125 | DAC8775 | |

(1) The marketing status values are defined as follows:

ACTIVE: Product device recommended for new designs.

LIFEBUY: TI has announced that the device will be discontinued, and a lifetime-buy period is in effect.

NRND: Not recommended for new designs. Device is in production to support existing customers, but TI does not recommend using this part in a new design.

PREVIEW: Device has been announced but is not in production. Samples may or may not be available.

OBSOLETE: TI has discontinued the production of the device.

(2) **RoHS:** TI defines "RoHS" to mean semiconductor products that are compliant with the current EU RoHS requirements for all 10 RoHS substances, including the requirement that RoHS substance do not exceed 0.1% by weight in homogeneous materials. Where designed to be soldered at high temperatures, "RoHS" products are suitable for use in specified lead-free processes. TI may reference these types of products as "Pb-Free".

RoHS Exempt: TI defines "RoHS Exempt" to mean products that contain lead but are compliant with EU RoHS pursuant to a specific EU RoHS exemption.

Green: TI defines "Green" to mean the content of Chlorine (Cl) and Bromine (Br) based flame retardants meet JS709B low halogen requirements of <=1000ppm threshold. Antimony trioxide based flame retardants must also meet the <=1000ppm threshold requirement.

(3) MSL, Peak Temp. - The Moisture Sensitivity Level rating according to the JEDEC industry standard classifications, and peak solder temperature.

(4) There may be additional marking, which relates to the logo, the lot trace code information, or the environmental category on the device.

(5) Multiple Device Markings will be inside parentheses. Only one Device Marking contained in parentheses and separated by a "~" will appear on a device. If a line is indented then it is a continuation of the previous line and the two combined represent the entire Device Marking for that device.

(6) Lead finish/Ball material - Orderable Devices may have multiple material finish options. Finish options are separated by a vertical ruled line. Lead finish/Ball material values may wrap to two lines if the finish value exceeds the maximum column width.

Important Information and Disclaimer: The information provided on this page represents TI's knowledge and belief as of the date that it is provided. TI bases its knowledge and belief on information provided by third parties, and makes no representation or warranty as to the accuracy of such information. Efforts are underway to better integrate information from third parties. TI has taken and continues to take reasonable steps to provide representative and accurate information but may not have conducted destructive testing or chemical analysis on incoming materials and chemicals. TI and TI suppliers consider certain information to be proprietary, and thus CAS numbers and other limited information may not be available for release.

In no event shall TI's liability arising out of such information exceed the total purchase price of the TI part(s) at issue in this document sold by TI to Customer on an annual basis.

RWF0072A



PACKAGE OUTLINE

VQFN - 0.9 mm max height

PLASTIC QUAD FLATPACK - NO LEAD

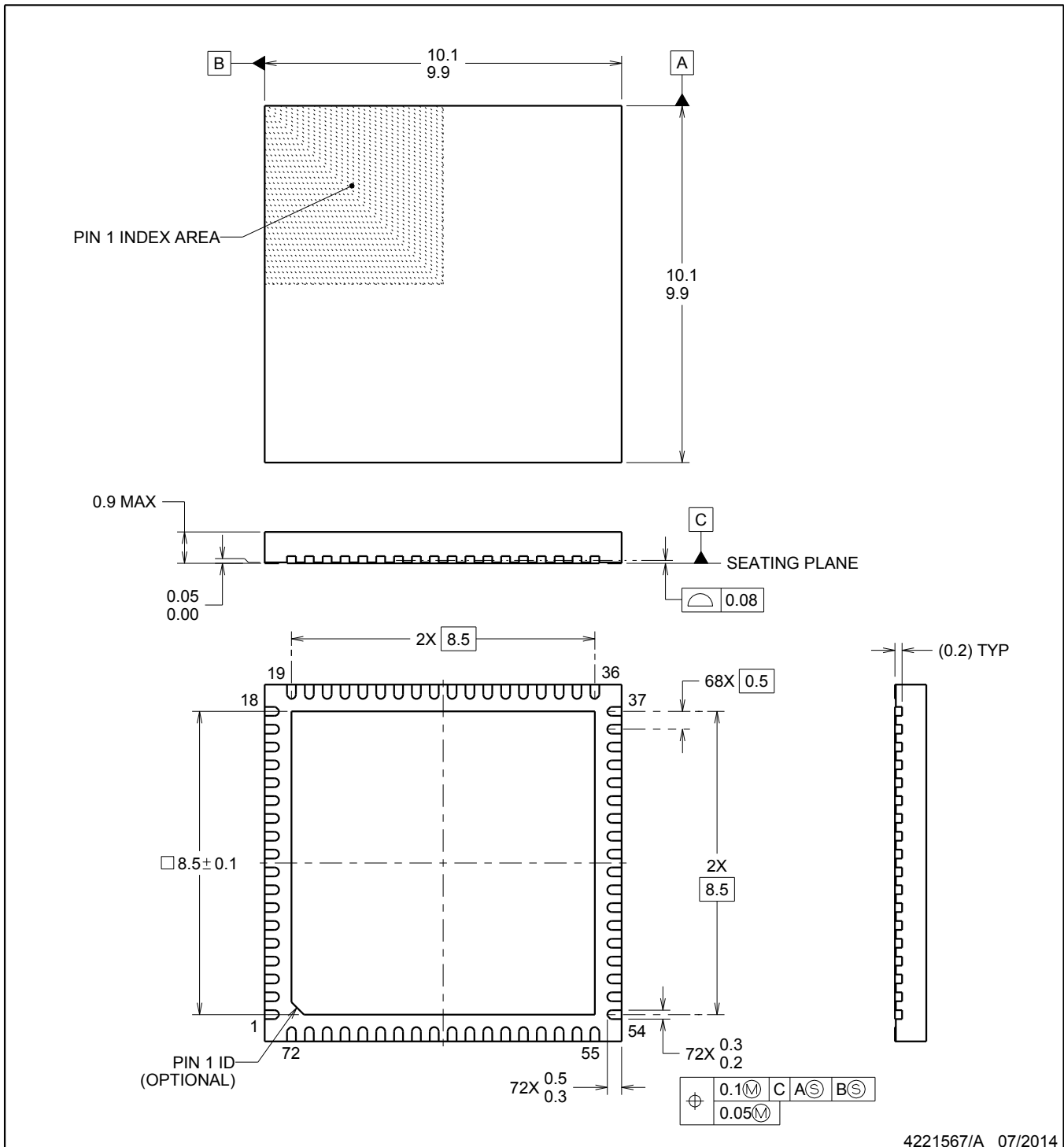

4221567/A 07/2014

NOTES:

1. All linear dimensions are in millimeters. Any dimensions in parenthesis are for reference only. Dimensioning and tolerancing per ASME Y14.5M.
2. This drawing is subject to change without notice.
3. The package thermal pad must be soldered to the printed circuit board for thermal and mechanical performance.

EXAMPLE BOARD LAYOUT

RWF0072A

VQFN - 0.9 mm max height

PLASTIC QUAD FLATPACK - NO LEAD

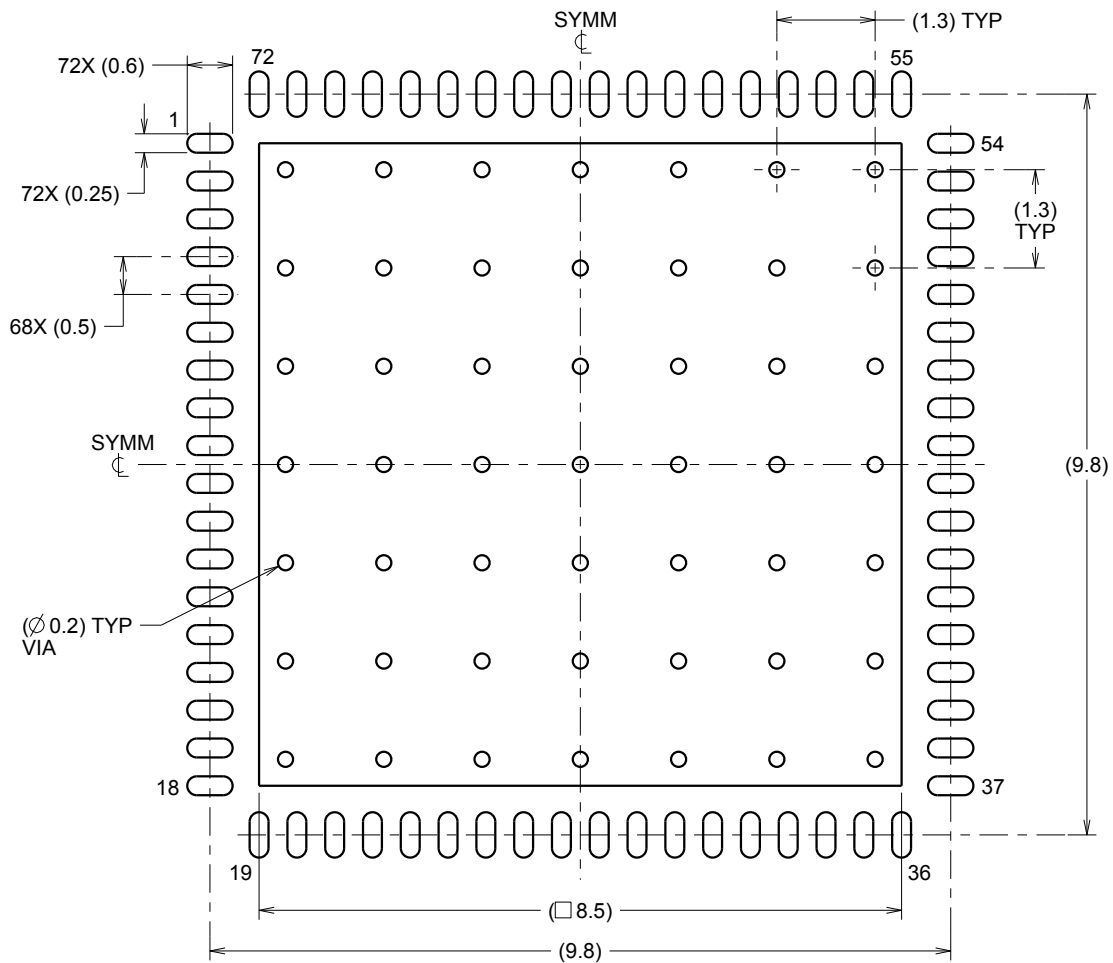

LAND PATTERN EXAMPLE
SCALE:10X

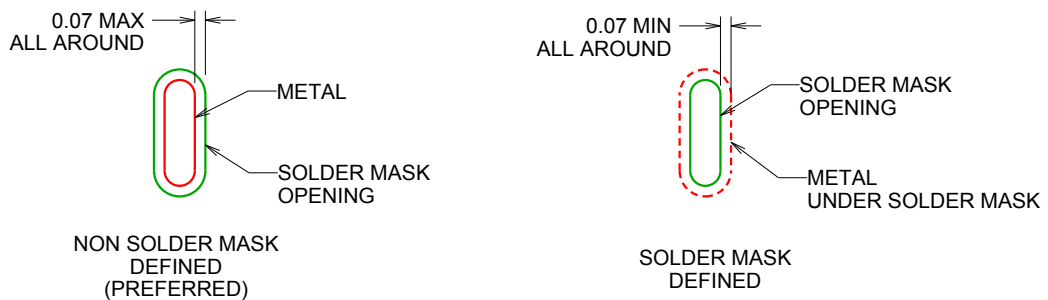

SOLDER MASK DETAILS

4221567/A 07/2014

NOTES: (continued)

4. This package is designed to be soldered to a thermal pad on the board. For more information, see Texas Instruments literature number SLUA271 (www.ti.com/lit/sluea271).

EXAMPLE STENCIL DESIGN

RWF0072A

VQFN - 0.9 mm max height

PLASTIC QUAD FLATPACK - NO LEAD

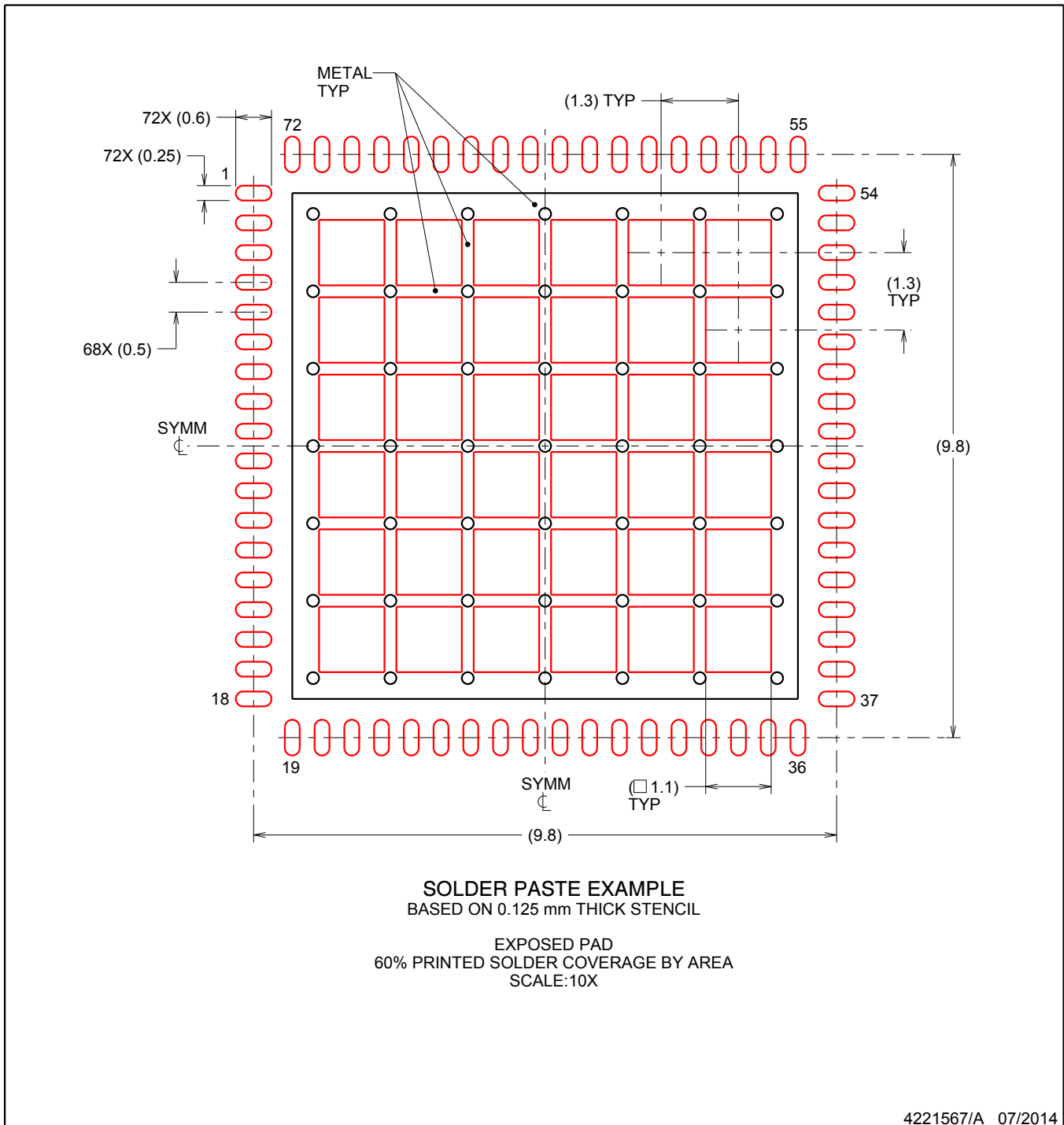

NOTES: (continued)

5. Laser cutting apertures with trapezoidal walls and rounded corners may offer better paste release. IPC-7525 may have alternate design recommendations.

重要なお知らせと免責事項

TI は、技術データと信頼性データ(データシートを含みます)、設計リソース(リファレンス・デザインを含みます)、アプリケーションや設計に関する各種アドバイス、Web ツール、安全性情報、その他のリソースを、欠陥が存在する可能性のある「現状のまま」提供しており、商品性および特定目的に対する適合性の黙示保証、第三者の知的財産権の非侵害保証を含むいかなる保証も、明示的または黙示的にかかわらず拒否します。

これらのリソースは、TI 製品を使用する設計の経験を積んだ開発者への提供を意図したものです。(1) お客様のアプリケーションに適した TI 製品の選定、(2) お客様のアプリケーションの設計、検証、試験、(3) お客様のアプリケーションに該当する各種規格や、その他のあらゆる安全性、セキュリティ、規制、または他の要件への確実な適合に関する責任を、お客様のみが単独で負うものとし、

上記の各種リソースは、予告なく変更される可能性があります。これらのリソースは、リソースで説明されている TI 製品を使用するアプリケーションの開発の目的でのみ、TI はその使用をお客様に許諾します。これらのリソースに関して、他の目的で複製することや掲載することは禁止されています。TI や第三者の知的財産権のライセンスが付与されている訳ではありません。お客様は、これらのリソースを自身で使用した結果発生するあらゆる申し立て、損害、費用、損失、責任について、TI およびその代理人を完全に補償するものとし、TI は一切の責任を拒否します。

TI の製品は、[TI の販売条件](#)、または [ti.com](#) やかかる TI 製品の関連資料などのいずれかを通じて提供する適用可能な条項の下で提供されています。TI がこれらのリソースを提供することは、適用される TI の保証または他の保証の放棄の拡大や変更を意味するものではありません。

お客様がいかなる追加条項または代替条項を提案した場合でも、TI はそれらに異議を唱え、拒否します。

郵送先住所 : Texas Instruments, Post Office Box 655303, Dallas, Texas 75265
Copyright © 2024, Texas Instruments Incorporated