

BQ21088 パワーパス、シップモード、シャットダウンモード、バッテリー トラッキング VINDPM 付き、I²C 制御、1セル、1A リニア バッテリー チャージャ

1 特長

- 1A リニア バッテリー チャージャ
 - バッテリー間充電と USB アダプタ用の入力動作電圧範囲: 3.0V~5.5V
 - バッテリーレギュレーション電圧を 3.6V~4.65V の間で 10mV 刻み、精度 0.5% で設定可能
 - リチウムイオン電池、リチウムポリマー電池、LiFePO4 電池をサポート
 - 5mA ~ 1A の設定可能な高速充電電流
 - 55mΩ バッテリー FET オン抵抗
 - 最大 3A の放電電流で高いシステム負荷に対応
 - JEITA サポートを含む NTC 充電プロファイルのスレッシュホールドを設定可能
- システム電源およびバッテリー充電用のパワーパス管理
 - バッテリー電圧トラッキングと入力パススルーのオプションに加えて、4.4V ~ 4.9V の範囲でレギュレートされたシステム電圧 (SYS)
 - ハイインピーダンス入力ソース用のバッテリートラッキング入力電圧ダイナミック パワー マネージメント (VINDPM)
- 非常に低い静止電流
 - バッテリー単独モードで 4μA
 - 30μA 入力アダプタ I_q (スリープモード)
- 1つの押しボタンによるウェイクアップおよびリセット入力
- フォルト保護機能内蔵
 - 入力過電圧保護 (VIN_OVP)
 - バッテリー短絡保護 (BATSC)
 - バッテリー過電流保護 (BATOCP)
 - 入力電流制限保護 (ILIM)
 - サーマルレギュレーション (TREG) およびサーマルシャットダウン (TSHUT)
 - バッテリー過熱フォルト保護 (TS)
 - ウォッチドッグおよび安全タイマフォルト

2 アプリケーション

- TWS ヘッドセットと充電ケース
- スマート眼鏡、AR、VR
- スマートウォッチ、その他のウェアラブルデバイス
- リテールオートメーションおよびペイメント
- ビルオートメーション

3 概要

BQ21088 は、小さなソリューション サイズと、バッテリー寿命を延長するための低い静止電流に重点を置いたリニア バッテリー チャージャ IC です。このデバイスは、製造に HDI PCB プロセスを必要せず、PCB コストを削減可能な 8 ボール チップスケール パッケージ、供給されます。このデバイスは、最大 1A の充電および最大 3A のシステム負荷をサポートできます。

パッケージ情報

部品番号	パッケージ ⁽¹⁾	パッケージサイズ ⁽²⁾	本体サイズ (公称)
BQ21088	YBG (DSBGA 8)	1.6 mm × 1.1mm	1.6 mm × 1.1mm

- 供給されているすべてのパッケージについては、[セクション 13](#) を参照してください。
- パッケージサイズ (長さ × 幅) は公称値であり、該当する場合はピンも含まれます。

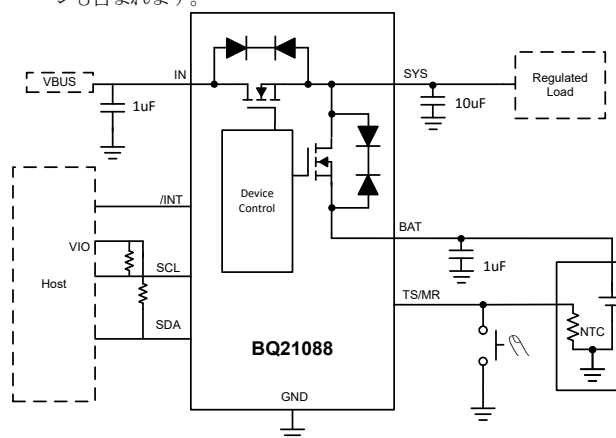

概略回路図



Table of Contents

1 特長	1	8 Application and Implementation	41
2 アプリケーション	1	8.1 Application Information.....	41
3 概要	1	8.2 Typical Application.....	41
4 概要 (続き)	3	9 Power Supply Recommendations	46
5 Pin Configuration and Functions	4	10 Layout	47
6 Specifications	5	10.1 Layout Guidelines.....	47
6.1 Absolute Maximum Ratings.....	5	10.2 Layout Example.....	47
6.2 ESD Ratings.....	5	11 Device and Documentation Support	48
6.3 Thermal Information.....	5	11.1 Device Support.....	48
6.4 Recommended Operating Conditions.....	5	11.2 Documentation Support.....	48
6.5 Electrical Characteristics.....	6	11.3 ドキュメントの更新通知を受け取る方法.....	48
6.6 Timing Requirements.....	9	11.4 サポート・リソース.....	48
6.7 Typical Characteristics.....	11	11.5 Trademarks.....	48
7 Detailed Description	12	11.6 静電気放電に関する注意事項.....	48
7.1 Overview.....	12	11.7 用語集.....	48
7.2 Functional Block Diagram.....	16	12 Revision History	48
7.3 Feature Description.....	16	13 Mechanical, Packaging, and Orderable Information	49
7.4 Device Functional Modes.....	25		
7.5 Register Maps.....	27		

4 概要 (続き)

バッテリーは、標準のリチウムイオンまたは LiFePO4 充電プロファイルを使用して、プリチャージ、定電流、定電圧の 3 つのフェーズで充電されます。サーマルレギュレーションにより、デバイス温度を管理しながら最大充電電流を供給できます。また、このチャージャは、3V の最小入力電圧で動作するバッテリー間充電に最適化されており、25V の絶対最大ライン過渡電圧に耐えられます。このデバイスには、1 つの押しボタン入力が内蔵されているため、ソリューション全体の占有面積を減らすことができます。

5 Pin Configuration and Functions



図 5-1. YBG Package WCSP 8 Pin (Top View)

表 5-1. Pin Functions

PIN		I/O ⁽¹⁾	DESCRIPTION
NAME	NO.		
IN	A2	P	DC Input Power Supply. IN is connected to the external DC supply. Bypass IN to GND with at least 1 μ F of effective capacitance using a ceramic capacitor.
SYS	B2	P	Regulated System Output. Connect at least 10- μ F ceramic capacitor (at least 1 μ F of ceramic capacitance with DC bias de-rating) from SYS to GND as close to the SYS and GND pins as possible.
BAT	C2	P	Battery Connection. Connect to the positive terminal of the battery. Bypass BAT to GND with at least 1 μ F of ceramic capacitance.
GND	D2	-	Ground connection. Connect to the ground plane of the circuit.
SCL	B1	I/O	I ² C Interface Clock. Connect SCL to the logic rail through a 10-k Ω resistor.
SDA	C1	I/O	I ² C Interface Data. Connect SDA to the logic rail through a 10-k Ω resistor.
/INT	A1	O	INT is an open-drain output that signals fault interrupts. When a fault occurs, a 128- μ s active low pulse is sent out as an interrupt for the host. INT is enabled/disabled using the MASK_INT bit in the control register. Can be pulled up to a 1- to 20-k Ω resistor. Typical pull-up voltage = 1.8 V, max pull-up voltage = 5 V.
TS/MR	D1	I/O	Manual Reset Input/ NTC thermistor pin. TSMR is a general purpose input that must be held low for greater than t_{L_PRESS} to go into Shipmode or perform a hardware reset. It can also be used to detect shorter button press durations such as t_{wake1} and t_{wake2} . TSMR may be driven by a momentary push-button or a MOS switch. The TSMR pin will also have an NTC thermistor connected on to it.

(1) I = Input, O = Output, I/O = Input or Output, G = Ground, P = Power.

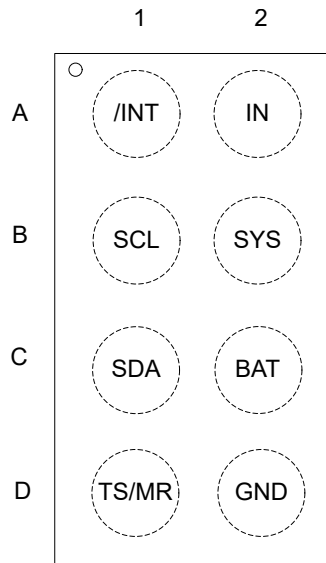
6 Specifications

6.1 Absolute Maximum Ratings

over operating free-air temperature range (unless otherwise noted)⁽¹⁾

		MIN	MAX	UNIT
Input Voltage	IN	-0.3	25	V
Voltage	All other pins	-0.3	5.5	V
Input Current (DC)	IN		1.1	A
Output Sink Current	/INT		20	mA
T _J	Junction temperature	-40	150	°C
T _{stg}	Storage temperature	-65	150	°C

- (1) Stresses beyond those listed under *Absolute Maximum Rating* may cause permanent damage to the device. These are stress ratings only, which do not imply functional operation of the device at these or any other conditions beyond those indicated under *Recommended Operating Condition*. Exposure to absolute-maximum-rated conditions for extended periods may affect device reliability.

6.2 ESD Ratings

			VALUE	UNIT
V _(ESD)	Electrostatic discharge	Human body model (HBM), per ANSI/ESDA/ JEDEC JS-001, all pins ⁽¹⁾	±2500	V
		Charged device model (CDM), per ANSI/ESDA/ JEDEC JS-002, all pins ⁽²⁾	±1500	

- (1) JEDEC document JEP155 states that 500-V HBM allows safe manufacturing with a standard ESD control process.
 (2) JEDEC document JEP157 states that 250-V CDM allows safe manufacturing with a standard ESD control process.

6.3 Thermal Information

THERMAL METRIC ⁽¹⁾		BQ25185	UNIT
		DLH	
		10	
R _{θJA}	Junction-to-ambient thermal resistance (JEDEC ⁽¹⁾)	107.1	°C/W
R _{θJC(top)}	Junction-to-case (top) thermal resistance	0.9	°C/W
R _{θJB}	Junction-to-board thermal resistance	30.3	°C/W
Ψ _{JT}	Junction-to-top characterization parameter	0.3	°C/W
Ψ _{JB}	Junction-to-board characterization parameter	30.3	°C/W
R _{θJC(bot)}	Junction-to-case (bottom) thermal resistance	N/A	°C/W

- (1) For more information about traditional and new thermal metrics, see the [Semiconductor and IC Package Thermal Metrics](#) application report.

6.4 Recommended Operating Conditions

over operating free-air temperature range (unless otherwise noted)

		MIN	NOM	MAX	UNIT
VBAT	Battery Voltage Range	2.2		4.6	V
VIN	Input Voltage Range	2.7		5.5	V
IIN	Input Current Range (IN to SYS)			1.1	A
ISYS (DC)	SYS Discharge Current (DC)			2	A
ISYS (Peak)	SYS Discharge Current (tpulse < 20mS)			3	A
IBAT	Battery Discharge Current (BAT to SYS)			3	A
TJ	Operating Junction Temperature Range	-40		125	°C

6.5 Electrical Characteristics

VIN = 5V, VBAT = 3.6V. TJ = 25°C unless otherwise noted.

PARAMETER		TEST CONDITIONS	MIN	TYP	MAX	UNIT
INPUT CURRENTS						
I _{Q_IN}	Input supply quiescent current	VBAT = 3.6V, VIN = 5V, Charge enabled, ICHG = 0mA, SYSREG = 4.5V		0.75	1	mA
I _{Q_IN}	Input supply quiescent current	VBAT = 3.6V, VIN = 5V, Charge enabled, ICHG = 0mA, SYSREG = Passthrough		0.660	1.5	mA
I _{SLEEP_IN}	SLEEP input current	VIN = 3.6V, VBAT = 3.7V		30		μA
I _{Q_BAT}	Battery quiescent current	V _{IN} < V _{UVLO} or floating, Watchdog disabled, Push button disabled, I2C functional. VBAT = 3.6V TJ = 25°C		3	3.5	μA
I _{Q_BAT}	Battery quiescent current	V _{IN} < V _{UVLO} , VBAT = 3.6V, Push-button function enabled, 0°C < TJ < 85°C		4	5	μA
I _{BAT_SHUTDOWN}	Battery discharge current in Shutdown Mode	VIN = 0V, Shutdown Mode, VBAT = 3.6V, Adapter Sense wake enabled.		30		nA
I _{BAT_SHIP}	Battery discharge current in Ship Mode	VBAT = 3.6V, Push button function enabled (average current), 0°C < TJ < 85°C		3.2	5	μA
POWER-PATH MANAGEMENT AND INPUT						
V _{IN_OP}	Input voltage operating range		3.6		5.5	V
V _{IN_UVLOZ}	Exit IN undervoltage lock-out	IN rising			3	V
V _{IN_UVLO}	Enter IN undervoltage lock-out	IN falling			2.7	V
V _{IN_LOWV}	IN voltage to start charging	IN rising		3	3.15	V
V _{IN_LOWVZ}	IN voltage to stop charging	IN falling		2.95	3.1	V
V _{IN_PORZ}	IN voltage threshold to enter shipmode	IN falling	1.09	1.3	1.66	V
V _{SLEEP}	Enter sleep mode threshold	IN falling, VIN - VBAT, VBAT = 4V		82		mV
V _{SLEEPZ}	Exit sleep mode threshold	IN rising, VIN - VBAT, VBAT = 4V	168	208	262	mV
V _{IN_OVP}	VIN overvoltage rising threshold	IN rising	5.5	5.7	5.9	V
V _{IN_OVP_HYS}	IN overvoltage hysteresis	IN falling		125		mV
I _{BAT_OCP}	BATOCP(Reverse OCP only)	VBAT = 4V, IBAT_OCP= 00		0.5		A
		VBAT = 4V, IBAT_OCP= 01		1.05		A
		VBAT = 4V, IBAT_OCP= 10		1.65		A
		VBAT = 4V, IBAT_OCP= 11		3		A
I _{BAT_OCPACC}	Battery OCP Accuracy	IBAT= 3 A, TJ = 27C			18	%
VBSUP1	Enter supplement mode threshold	VBAT = 3.6V, VBAT > V _{BUVLO} , V _{SYS} < VBAT-VBSUP1		40		mV
VBSUP2	Exit supplement mode threshold	V _{BAT} > V _{BUVLO} , V _{SYS} >VBAT-VBSUP2		20		mV
ILIM	Input Current Limit	VIN = 5V, ILIM = 50mA	40	50	60	mA
		VIN = 5V, ILIM = 100mA	80	90	98	mA
		VIN = 5V, ILIM = 200mA	180	200	220	mA
		VIN = 5V, ILIM = 300mA	270	300	330	mA
		VIN = 5V, ILIM = 380mA	360	380	400	mA
		VIN = 5V, ILIM = 500mA	450	475	498	mA
		VIN = 5V, ILIM = 665mA	630	665	700	mA
VIN = 5V, ILIM = 1050mA	995	1050	1100	mA		
V _{INDPM_ACC}	VINDPM accuracy	VINDPM target is not disabled	-3		3	%

6.5 Electrical Characteristics (続き)

VIN = 5V, VBAT = 3.6V. TJ = 25°C unless otherwise noted.

PARAMETER		TEST CONDITIONS	MIN	TYP	MAX	UNIT
V _{INDPM}	Input voltage threshold when input current is reduced	VINDPM target = VBAT + V _{INDPM_TRACK}		VBAT + V _{INDPM_TRACK}		V
	Input voltage threshold when input current is reduced	VINDPM target = 4.5V		4.5		V
	Input voltage threshold when input current is reduced	VINDPM target = 4.7V		4.7		V
V _{INDPM_TRACK}	Input voltage threshold offset for when input current is reduced and when VBAT > 3.5 V	VINDPM target = VBAT + V _{INDPM_TRACK}		330		mV
V _{DPPM}	SYS voltage threshold when charge current is reduced	VBAT = 3.6V, VSYS = V _{DPPM} + VBAT before charge current is reduced.		0.1		V
V _{SYS_REG_ACCURACY}	Programmable SYS voltage regulation accuracy	VIN = 5V, VBAT = 3.6V, RSYS = 100ohm, SYS regulation target = 4.4V to 4.9V	-2		2	%
V _{MINSYS}	Minimum SYS voltage when in battery tracking mode	VBAT < 3.6V		3.8		V
V _{SYS_TRACK}	Voltage regulation threshold for SYS when VBAT > 3.6V in battery tracking mode	VBAT = 4V, VSYS = VBAT + V _{SYS_TRACK}		225		mV
R _{SYS_PD}	SYS pull down resistance	V _{SYS} = 3.6V		20		Ω
V _{SYS_SHORT}	Voltage threshold for detecting SYS_SHORT condition has occurred	falling voltage		0.86		V
V _{SYS_SHORT_HYS}	Voltage threshold for exiting SYS_SHORT condition has occurred	rising voltage		1.1		V
BATTERY CHARGER						
R _{ON_BAT}	Battery FET on-resistance	VBAT = 4.5V, IBAT = 500mA		55	90	mΩ
R _{ON_IN}	Input FET on-resistance	IN = 5V, IIN = 0.8A		330	470	mΩ
V _{REG_RANGE}	Typical BAT charge voltage regulation range	10mV steps, programmable through I ² C	3.5		4.65	V
V _{REG_ACC}	BAT charge voltage accuracy, summary for all settings	All VBATREG settings, typical measurement at VBATREG = 4.2V	-0.5		0.5	%
I _{CHG_RANGE}	Typical charge current regulation range	V _{BAT} > V _{LOWV}	5		1000	mA
I _{CHG_ACC}	Charge current accuracy	VIN = 5V, Fastcharge >=40mA	-10		10	%
I _{CHG_ACC}	Charge current accuracy	Fastcharge current = 5mA	4.1	5	5.5	mA
I _{CHG_ACC}	Charge current accuracy	Fastcharge current = 40mA	36	40	44	mA
I _{CHG_ACC}	Charge current accuracy	Fastcharge current = 630mA	567	630	693	mA
I _{PRECHG}	Typical pre-charge current, as percentage of ICHG	V _{OUT} < V _{LOWV}		20		%
I _{PRECHG_ACC}	Precharge current accuracy	Fastcharge current >=40mA	-10		10	%
I _{TERM}	Typical termination current, as percentage of ICHG	V _{OUT} = VBATREG		10		%
I _{TERM_ACC}	Termination current accuracy	IBAT = 3mA (ICHG= 30mA) Tj = 25°C	-10		10	%
I _{TERM_ACC}	Termination current accuracy	IBAT = 3mA (ICHG= 30mA) Tj = 25°C	2.7		3.3	mA
V _{LOWV}	Pre-charge to fast-charge transition threshold	VLOWVSEL = 3.0V, VBAT rising	2.9	3	3.1	V
V _{LOWV}	Pre-charge to fast-charge transition threshold	VLOWVSEL = 2.8V, VBAT rising	2.7	2.8	2.9	V
V _{LOWV_HYS}	Battery LOWV hysteresis	All settings		100		mV

6.5 Electrical Characteristics (続き)

VIN = 5V, VBAT = 3.6V. TJ = 25°C unless otherwise noted.

PARAMETER		TEST CONDITIONS	MIN	TYP	MAX	UNIT
V _{BUVLO}	Battery UVLO, VBAT falling	BUVLO setting = b000		3		V
	Battery UVLO, VBAT falling	BUVLO setting = b011		2.8		V
	Battery UVLO, VBAT falling	BUVLO setting = b100		2.6		V
	Battery UVLO, VBAT falling	BUVLO setting = b101		2.4		V
	Battery UVLO, VBAT falling	BUVLO setting = b110		2.2		V
	Battery UVLO, VBAT falling	BUVLO setting = b111		2.0		V
V _{BUVLO_HYS}	Battery UVLO hysteresis, VBAT rising	Any BUVLO Setting, value above VBAT, VIN = 5V	110	150	190	mV
V _{BUVLO_HYS}	Battery UVLO hysteresis, VBAT rising	Any BUVLO Setting, value above VBAT, VIN = 0V	90	150	210	mV
V _{BATPOR}	Battery only power up voltage, VBAT rising	-40C < Tj < 125C	3.08	3.21	3.46	V
V _{RCH}	Battery Recharge Threshold	BAT falling, VRCH bit = 0	75	100	130	mV
		BAT falling, VRCH bit = 1	175	200	230	mV
V _{BATSC}	Short on battery threshold for trickle charge, VBAT rising		1.6	1.8	2.0	V
V _{BATSC_HYS}	Battery short circuit voltage hysteresis			200		mV
I _{BATSC}	Trickle Charge Current	VBAT < V _{BATSC}		1		mA
TEMPERATURE REGULATION AND TEMPERATURE SHUTDOWN						
T _{REG}	Typical junction temperature regulation	THERM_REG = 00		100		°C
T _{REG}	Typical junction temperature regulation	THERM_REG = 01		80		°C
T _{REG}	Typical junction temperature regulation	THERM_REG = 10		60		°C
T _{REG}	Typical junction temperature regulation	THERM_REG = 11		Disabled		
T _{SHUT_RISING}	Thermal shutdown rising threshold	Temperature increasing		150		°C
T _{SHUT_FALLING}	Thermal shutdown falling threshold	Temperature decreasing		135		°C
BATTERY NTC MONITOR						
I _{TS_BIAS}	TS nominal bias current		36.5	38	39.5	μA
V _{T1_Entry}	Cold - 00 @ Approx. 0°C, default	VIN = 5V	0.9575	1.0075	1.0575	V
V _{T2_Entry}	Cold - 01 @ Approx. 3°C	VIN = 5V	0.8450	0.8900	0.9325	V
V _{T3_Entry}	Cold - 10 @ Approx. 5°C	VIN = 5V	0.7775	0.8200	0.8600	V
V _{T4_Entry}	Cold - 11 @ Approx. -3°C	VIN = 5V	1.0850	1.1425	1.2000	V
V _{T5_Entry}	Cool - 00 @ Approx. 10°C, default	VIN = 5V	0.6350	0.6700	0.7025	V
V _{T6_Entry}	Warm - 00 @ Approx. 45°C, default	VIN = 5V	0.1730	0.1850	0.198	V
V _{T7_Entry}	Hot - 00 @ Approx. 60°C, default	VIN = 5V	0.1050	0.1150	0.1250	V
V _{T8_Entry}	Hot - 01 @ Approx. 65°C	VIN = 5V	0.0875	0.0975	0.1075	V
V _{T9_Entry}	Hot - 10 @ Approx. 50°C	VIN = 5V	0.1475	0.1575	0.1675	V
V _{T10_Entry}	Hot - 11 @ Approx. 45°C	VIN = 5V	0.1750	0.1850	0.1950	V
V _{T1_Exit}	Cold - 00 @ Approx. 5°C, default	VIN = 5V	0.7775	0.8200	0.8600	V
V _{T2_Exit}	Cold - 01 @ Approx. 8°C	VIN = 5V	0.6875	0.7250	0.7600	V
V _{T3_Exit}	Cold - 10 @ Approx. 10°C	VIN = 5V	0.6350	0.6700	0.7025	V
V _{T4_Exit}	Cold - 11 @ Approx. 2°C	VIN = 5V	0.8800	0.9275	0.9725	V
V _{T5_Exit}	Cool - 00 @ Approx. 15°C, default	VIN = 5V	0.5225	0.5500	0.5775	V
V _{T6_Exit}	Warm - 00 @ Approx. 41°C, default	VIN = 5V	0.2080	0.2200	0.235	V
V _{T7_Exit}	Hot - 00 @ Approx. 55°C, default	VIN = 5V	0.1250	0.1350	0.1450	V
V _{T8_Exit}	Hot - 01 @ Approx. 60°C	VIN = 5V	0.1050	0.1150	0.1250	V

6.5 Electrical Characteristics (続き)

VIN = 5V, VBAT = 3.6V. TJ = 25°C unless otherwise noted.

PARAMETER		TEST CONDITIONS	MIN	TYP	MAX	UNIT
V _{T9_Exit}	Hot - 10 @ Approx. 45°C	VIN = 5V	0.1750	0.1850	0.1950	V
V _{T10_Exit}	Hot - 11 @ Approx. 40°C	VIN = 5V	0.2100	0.2200	0.23	V
V _{TS_ENZ}	TS monitoring enable threshold VTSMR < VTS_ENZ for TS function to be enabled	TS Rising, VIN = 5V	1.8	2.1	2.8	V
V _{TS_CLAMP}	TS maximum voltage clamp	TS open-circuit (float), VIN = 5V	2.2	2.8	3.3	V
PUSH BUTTON TIMERS AND THRESHOLDS						
I _{TSMR}	Adapter present		36.5	38	39.5	μA
I _{TSMR}	Battery only mode			60		μA
V _{TSMR}	TSMR voltage to detect a button press event, battery only mode				90	mV
V _{TSMR}	TSMR voltage to detect a button press event, adapter present				90	mV
t _{WAKE1}	WAKE1 Timer. Time from TSMR low detection	MR_WAKE1_TIMER = 0		300		ms
		MR_WAKE1_TIMER = 1		1		s
t _{WAKE2}	WAKE2 Timer. Time from TSMR low detection	MR_WAKE2_TIMER = 0		2		s
		MR_WAKE2_TIMER = 1		3		s
t _{RESET_WARN}	RESET_WARN Timer. Time prior to HW RESET	MR_RESET_WARN = 0	0.9	1	1.1	s
t _{LPRESS}	Long Press timer. Time from button press detection to long press action.	MR_LPRESS = 00	4.5	5	5.5	s
		MR_LPRESS = 01	9	10	11	s
		MR_LPRESS = 10	13.5	15	16.5	s
		MR_LPRESS = 11	18	20	22	s
t _{RESTART(AUTOWAKE)}	RESTART Timer. Time from HW Reset to SYS power up	AUTOWAKE = 00		0.5		s
		AUTOWAKE = 01		1		s
		AUTOWAKE = 10		2		s
		AUTOWAKE = 11		4		s
BATTERY CHARGING TIMERS						
t _{MAXCHG}	Charge safety timer	Programmable range	180		720	min
t _{PRECHG}	Precharge safety timer		0.25 * t _{MAXCHG}			
I2C INTERFACE						
I _{sink}	/PG pin current sink capability (QFN)	VBAT = 4V			20	mA
V _{IL}	Input low threshold level	VPULLUP = 1.8V, SDA and SCL			0.4	V
V _{IH}	Input high threshold level	VPULLUP = 1.8V, SDA and SCL	1.3			V
V _{OL}	Output low threshold level	IL = 5mA, sink current, VPULLUP = 1.8V			0.4	V
I _{LKG}	High-Level leakage current	VPULLUP = 1.8V			1	μA
LOGIC PINS						
V _{OL}	Output low threshold level	IL = 5mA, sink current, VPULLUP = 3.3V, /INT pin			0.4	V

6.6 Timing Requirements

		MIN	NOM	MAX	UNIT
INPUT					
t _{VIN_OVPZ_DGL}	VIN_OVP deglitch, VIN falling		30		ms
t _{SLEEP_DGL}	Deglitch time to enter SLEEP, VIN falling		64		μs

6.6 Timing Requirements (続き)

		MIN	NOM	MAX	UNIT
t _{VIN_WAKE}	V _{IN} Required for Shipmode or Shutdown Exit	10			ms
BATTERY CHARGER					
t _{REC_SC}	Recovery time, BATOCP during Discharge Mode		250		ms
t _{RETRY_SC}	Retry window for SYS or BAT short circuit recovery(BATOCP)		2		s
t _{BUVLO}	Deglintch time to disconnect the BATFET when VBAT < V _{BUVLO} setting		60		μs
t _{TS_DUTY_ON}	TS turnon-time (battery only mode)		4		ms
t _{TS_DUTY_OFF}	TS turnoff time (battery only mode)		196		ms
DIGITAL CLOCK, WATCHDOG and PUSHBUTTON					
t _{WDOG}	I2C interface reset timer, adjustable	40	160	Disabled	s
t _{I2CRESET}	I2C interface inactive reset timer		500		ms
t _{HW_RESET}	Hardware Reset	4		14	s
t _{SHIPWAKE}	Wake timer to count for ship mode (WAKE2 DefaultTimer)		2		s

6.7 Typical Characteristics

VIN = 5 V, CIN = 2.2 μF, COUT = 10 μF, CBAT = 1 μF (unless otherwise specified)

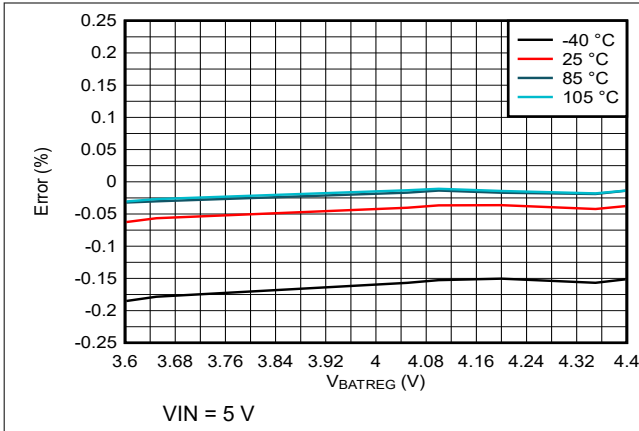

6-1. Battery Regulation Voltage Accuracy vs VBATREG Setting

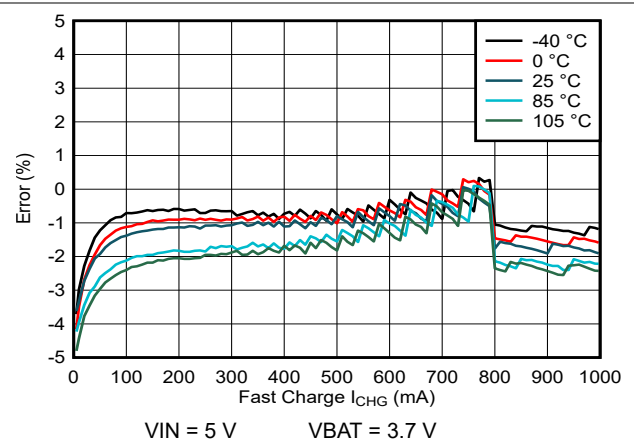

6-2. Charge Current Accuracy vs ICHARGE Setting

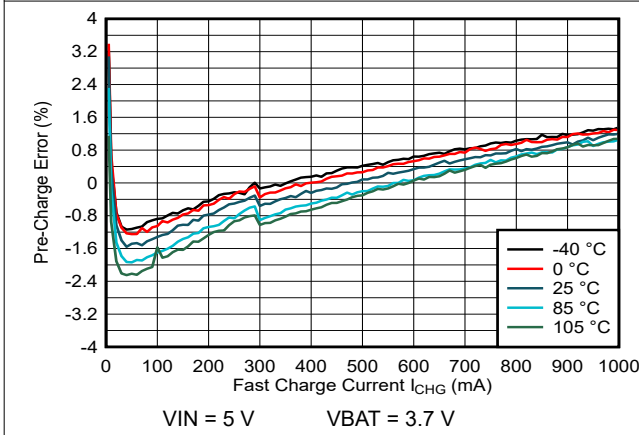

6-3. Precharge Accuracy vs Battery Voltage

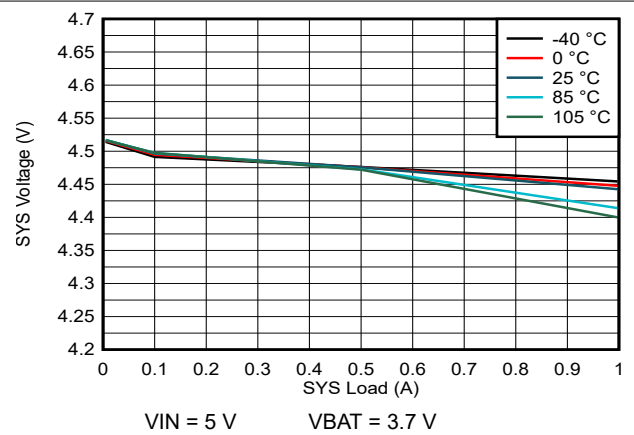

6-4. SYS Load Regulation

7 Detailed Description

7.1 Overview

The BQ21088 integrates a linear charger that allows the battery to be charged with a programmable charge current of up to 1 A. In addition to the charge current, other charging parameters can be programmed through I²C such as the precharge, termination, and input current limit.

The power path allows the system to be powered from a regulated output, SYS, even when the battery is empty or charging, by drawing power from IN pin. It also prioritizes the system load in SYS, reducing the charging current, if necessary, in order support the load when input power is limited. If the input supply is removed and the battery voltage level is above V_{BUVLO} , SYS will automatically and seamlessly switch to battery power.

Charging is done through the internal battery MOSFET. There are several loops that influence the charge current: constant current loop (CC), constant voltage loop (CV), input current limit, thermal regulation, VDPPM, and VINDPM. During the charging process, all loops are enabled and the one that is dominant takes control.

The device supports multiple battery chemistries for single-cell applications, through adjustable battery regulation voltage regulation (V_{BATREG}) and charge current (I_{CHG}) options.

7.1.1 Battery Charging Process

When a valid input source is connected ($V_{IN} > V_{INDPM}$ and $V_{BAT} + V_{SLEEP} < V_{IN} < V_{IN_OVP}$), the state of the CHARGE_DISABLE bit and the TS/MR pin determine whether a charge cycle is initiated. When the CHARGE_DISABLE bit is set to disable charging, $V_{HOT} < V_{TS/MR} < V_{COLD}$ and a valid input source is connected, the battery FET is turned off, preventing any kind of charging of the battery. Note that supplement behavior is independent of the CHARGE_DISABLE bit. The device will be able to charge a battery as long as VIN voltage is higher than the V_{IN_LOWV} threshold. This threshold is present as the VIN can be considered "powergood" with a very low battery voltage or a 0-V battery.

The following figure illustrates a typical charge cycle.



図 7-1. Charger Flow Diagram

7.1.1.1 Trickle Charge

In order to prevent damage to the battery, the device will charge the battery at a much lower current level known as trickle charge (I_{BATSC}) when the battery voltage (V_{BAT}) is below the V_{BATSC} threshold. During trickle charge, the device still counts against the precharge safety timer. Rather trickle charge and precharge are counting against the same duration of 25% of the fast charge timer.

7.1.1.2 Pre-Charge

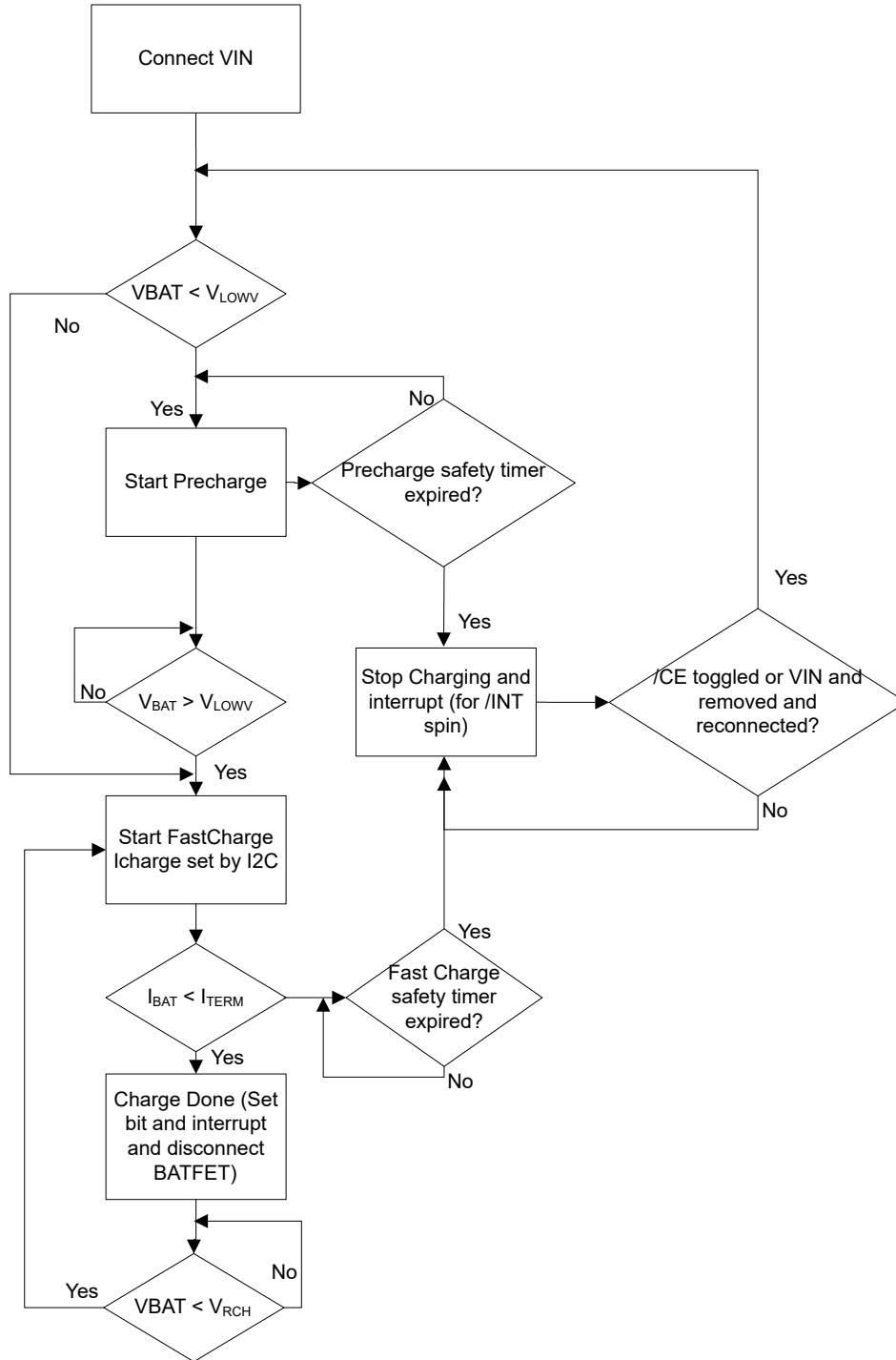
When battery voltage is above the V_{BATSC} but lower than V_{LOWV} threshold, the battery is charged with the pre-charge current (I_{PRECHG}). Pre-charge current is a multiplier of the termination current (Section 8.1.1.5 Termination). As a result, the pre-charge current is a percentage of the fast charge current (I_{CHG}).

When the battery voltage reaches the precharge to fast charge transition threshold (V_{LOWV}), the device charges the battery at the fast charge current. If the device does not exit pre-charge within 25% of the fast charge safety timer, the device will stop charging. For more information on safety timers, see Section 8.3.7.7. Safety Timer.

7.1.1.3 Fast Charge

The charger has two main control loops that control charging when $V_{BAT} > V_{LOWV}$: the Constant Current (CC) and Constant Voltage (CV) loops. When the CC loop is dominant, typically when $V_{BAT} < V_{BATREG} - V_{RCH}$, the battery is charged at the maximum charge current level I_{CHG} , unless there is a TS fault condition, (JEITA operation), VINDPM is active, thermal regulation or DPPM is active. (See respective sections for details on these modes of operation). Once the battery voltage approaches the V_{BATREG} level, the CV loops becomes more dominant and the charging current starts tapering off as shown in Typical Charging Profile of a Battery. Once the charging current reaches the termination current (I_{TERM}) the charge is done, then Charge_done status is set. If the I^2C of V_{BATREG} is set higher than 4.65 V, the battery regulation voltage is still maintained at 4.65 V. The device will switch to fast charge based on V_{LOWV} setting.

7.1.1.4 Termination

As the device CV loop becomes more dominate than the CC loop in fast charge operation, the charge current will taper and approach the I_{TERM} threshold. can be configured by I^2C transactions writing to the $ITERM_0$ bits.

表 7-1. Termination Based on $ITERM_0$ Bits

$ITERM_0$	TERMINATION THRESHOLD
0b00	Disabled
0b01	5 % of I_{CHG}
0b10	10 % of I_{CHG}
0b11	20 % of I_{CHG}

Once the I_{TERM} threshold is met during the CV phase, the device automatically terminates charge current by disabling the BATFET (disconnects the battery from SYS) to enter high impedance mode. If there is a regulation loop such as VINDPM, DPPM, or a thermal regulation loop that affects the charge current while the CV loop is tapering the charge current, termination will not occur. Charge current will continue to taper due to the active current affecting regulation loops and CV but the device will not terminate the charge current.

Termination only occurs when the CV loop is operating without any other regulation loops in effect that could reduce the charge current further. Post termination, the battery FET is disabled and the device monitors the BAT pin voltage. If the BAT pin voltage has dropped lower than the battery regulation voltage (V_{BATREG}) by the recharge threshold (V_{RCH}), a new charge cycle is started and safety timers are reset.

During charging or even when charge done, a higher SYS load will be supported through the supplement operation.

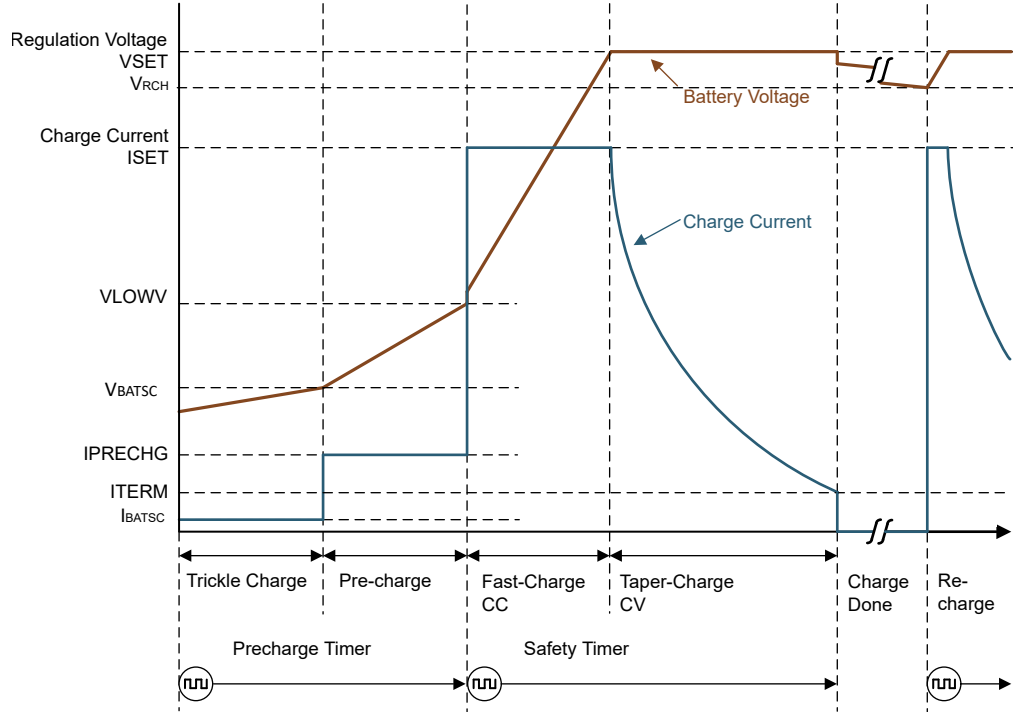

7-2. Typical Charging Profile of a Battery

7.2 Functional Block Diagram



图 7-3. Functional Block Diagram

7.3 Feature Description

7.3.1 Input Voltage Based Dynamic Power Management (VINDPM)

The VINDPM loop prevents the input voltage from collapsing to a point where charging would be interrupted. This is done by reducing the current drawn by charger enough to keep the input voltage above the VINDPM threshold (V_{INDPM}).

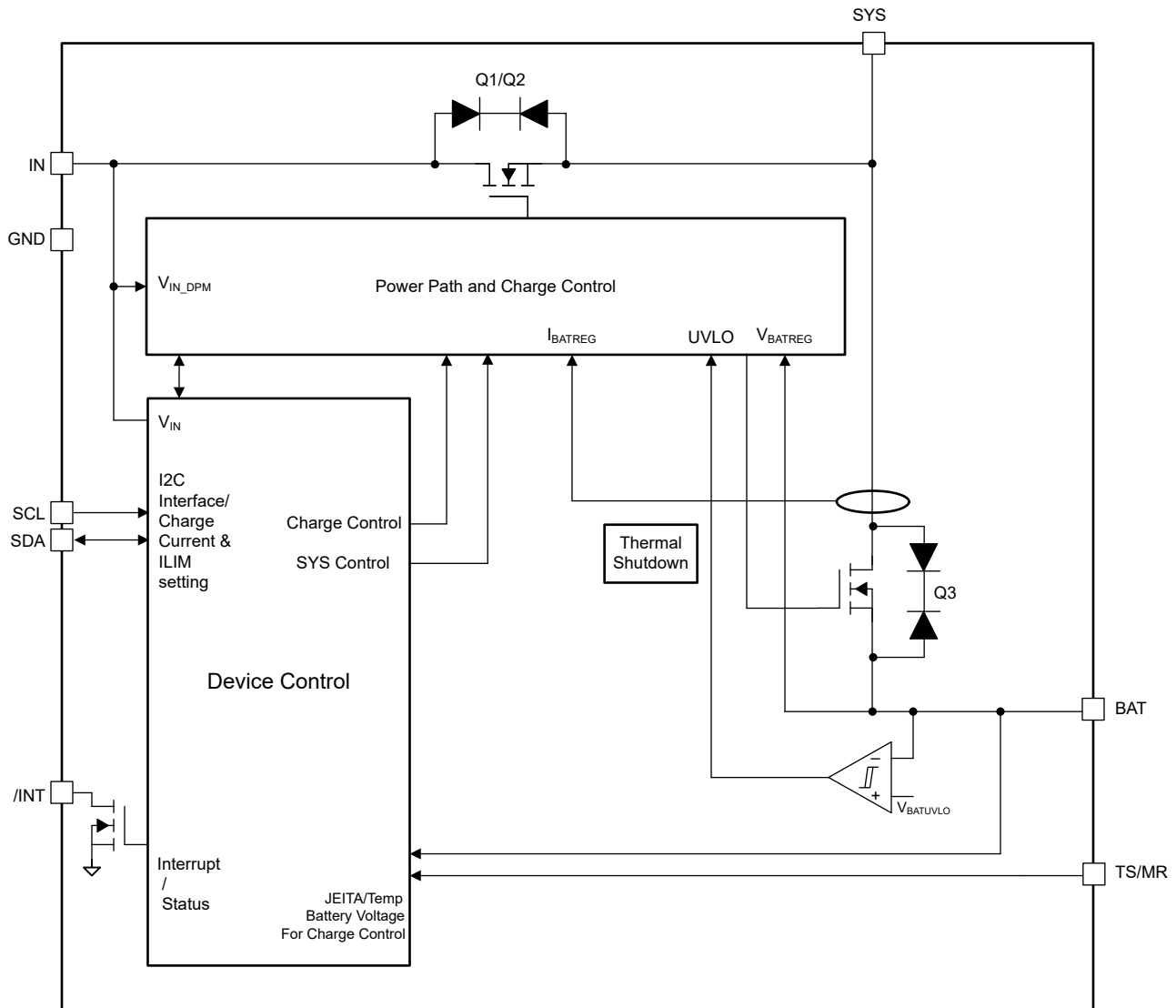
During the normal charging process, if the input power source is not able to support the programmed or default charging current and System load, the supply voltage decreases. Once the supply drops to the V_{INDPM} threshold, the input DPM current and voltage loops will reduce the input current through the blocking FETs to prevent the further drop of the supply.

The VINDPM threshold is programmable through the I²C register and can be completely disabled. This is set through the VINDPM_0 and VINDPM_1 selection bits. When the device enters this mode, the charge current may be lower than the set value and the VINDPM_ACTIVE_STAT bit is set. If the 2x timer is set through

2XTMR_EN bit, the safety timer is extended while VINDPM is active. The VINDPM threshold can be configured to track battery voltage. In BATTRACK mode, the VINDPM threshold 330 mV above VBAT or 3.6V, whichever is greater. Additionally, termination is disabled when VINDPM is active.

7.3.2 Dynamic Power Path Management Mode (DPPM)

With a valid input source connected, the power-path management circuitry monitors the input voltage and current continuously. The current into IN is shared at SYS between charging the battery and powering the system load at SYS. If the sum of the charging and load currents exceeds the preset maximum input current, the input DPM loop reduces input current. If SYS drops below the DPPM voltage threshold, the charging current is reduced by the DPPM loop through the BATFET. If SYS falls below the supplement mode threshold after BATFET charging current is reduced to zero, the part will enter supplement mode. SYS voltage is maintained above battery voltage when the DPPM loop is in control. Battery termination is disabled when the DPPM loop is active.

The VDPPM threshold is typically 100 mV above VBAT. The VDPPM disable bit (VDPPM_DIS = b1) will allow the charger to operate with lower headroom on VSYS. No current reduction occurs when the voltage between SYS and BAT is less than the VDPPM threshold. In VBAT tracking mode where VSYS is VBAT+225 mV, disabling this bit will have no effect.

7.3.3 Battery Supplement Mode

While in DPPM mode, if the charging current falls to zero and the system load current increases beyond the programmed input current limit, the voltage at SYS reduces further. When the SYS voltage drops below the battery voltage to V_{BSUP1} , the battery supplements the system load. The battery stops supplementing the system load when the voltage on the SYS pin rises within the battery voltage to V_{BSUP2} . During supplement mode, the battery supplement current is not regulated, however, the BATOCP protection circuit is active if enabled. Battery termination is disabled while in supplement mode. Battery voltage has to be higher than battery undervoltage lockout threshold (V_{BUVLO}) to be able to supplement the system.

7.3.4 Sleep Mode

The device enters the low-power sleep mode if V_{IN} falls below the sleep-mode entry threshold and V_{IN} is higher than the undervoltage lockout threshold. In sleep mode, the input is isolated from the battery. This feature prevents draining the battery during the absence of V_{IN} . When $V_{IN} < V_{BAT} + V_{SLEEP}$, the device turns the battery discharge FET on, sends a pulse on the INT output, and the VIN_PGOOD_STAT bits of the register is updated over I²C. Once $V_{IN} > V_{BAT} + V_{SLEEP}$ and V_{IN} exceeds the VINDPM threshold, the device initiates a new charge cycle.

7.3.5 SYS Power Control (SYS_MODE bit control)

The device also offers the option to control SYS through the I²C SYS_MODE bits. These bits can force SYS to be supplied by BAT instead of IN (even if $V_{IN} > V_{BAT} + V_{SLEEP}$), disconnect SYS from either supply, pull SYS down or leave it floating. The table below shows the device behavior based on SYS_MODE setting:

表 7-2. Settings

SYS_MODE	DESCRIPTION	SYS SUPPLY	SYS PULL-DOWN
00	Normal Operation	IN or BAT	Off except during HW reset
01	Force BAT power (USB Suspend)	BAT	Off except during HW reset
10	SYS Off – Floating	None	Off
11	SYS Off – Pulled Down	None	On

SYS_MODE = 00

This is the default state / normal operation of the device. SYS will be powered from IN if $V_{IN} > V_{UVLO}$, $V_{IN} > V_{BAT} + V_{SLEEP}$, and $V_{IN} < VIN_OVP$. SYS will powered by BAT if these conditions are not met. SYS will only be disconnected from IN or BAT and pulled down when a HW Reset occurs or the device goes into Ship mode.

SYS_MODE = 01

When this configuration is set, SYS will be powered by BAT if $V_{BAT} > V_{BUVLO}$ regardless of V_{IN} state. This allows the host to minimize the current draw from the adapter while it is still connected as needed in the system. If SYS_MODE = 01 is set while $V_{BAT} < V_{BUVLO}$, the SYS_MODE = 01 setting will be ignored and the device will go to SYS_MODE = 00. In the same manner, if the adapter (V_{IN}) is removed and then connected the device will also switch to SYS_MODE=00. This prevents the device from needing a POR in order to restore power to the system thereby allowing battery charging and providing a true USB suspend mode. If SYS_MODE = 01 is set during charging, charging will be stopped and the battery will start to provide power to SYS as needed. The behavior is similar to that when the input adapter is disconnected.

SYS_MODE = 10

When this configuration is set, SYS will be disconnected and left floating. The digital remains on and active. When floating, SYS can only be forced to a voltage up to V_{BAT} level. Toggling V_{IN} ($V_{IN} < V_{INUVLO}$) will reset the SYS_MODE to 00.

SYS_MODE = 11

When this configuration is set, SYS will be disconnected and pulled down to ground. Toggling V_{IN} will reset the SYS_MODE to 00.

7.3.5.1 SYS Pulldown Control

The device has an internal pulldown on the SYS pin which is enabled in the following cases:

表 7-3. States

STATE	NOTES
Shipmode	Pulldown on SYS is enabled once the device enters the shipmode and after disconnecting the BATFET
HW_RESET	Pulldown on SYS is enabled after the BATFET and ILIM FET are disconnected and retained until the autowake timer expires
SYS_MODE = 11 (SYS pulldown mode)	Pulldown on SYS is enabled after the BATFET and ILIM FET are disconnected and retained till either an I2C transaction – changing SYS_MODE or a hardware reset – is given or V_{IN} is toggled.

7.3.6 SYS Regulation

The BQ21088 includes a SYS voltage regulation loop. By regulating the SYS voltage the device prevents downstream devices connected to SYS from being exposed to voltages as high as VIN_OVP . SYS regulation is only active when $V_{IN} > V_{UVLO}$, $V_{IN} > V_{BAT} + V_{SLEEP}$ and $V_{IN} < VIN_OVP$ rather meeting the $VIN_Powergood$ condition.

SYS voltage regulation target can be controlled through the SYS_REG_CTRL_2:0 bits on the SYS_REG Register to either track the battery, set to a fixed voltage, or enable pass through modes.

In battery tracking mode, the minimum voltage is at V_{MINSYS} value for battery < 3.6 V. As battery voltage increases- V_{SYS} is regulated to 225 mV above battery. If $V_{IN} < V_{MINSYS}$ and $VIN_Powergood$ is still active, then the SYS will be in dropout.

In the fixed voltage mode, the SYS voltage is regulated to a target set by the host ranging from 4.4 V to 4.9 V . If V_{IN} voltage is less than the SYS target voltage, then the device will be in dropout mode.

表 7-4. Regulation

SYS_REG_CTRL	VSYS TARGET
000	$V_{BAT} + 225\text{ mV}$ (3.8 V minimum)

表 7-4. Regulation (続き)

SYS_REG_CTRL	VSYS TARGET
001	4.4
010 (default)	4.5
011	4.6
100	4.7
101	4.8
110	4.9
111	Passthrough

7.3.7 ILIM Control

The input current limit can be controlled through I²C by selecting the ILIM bits.

If the ILIM clamp is active, ILIM_ACTIVE_STAT bit is set.

The MASK_ILIM will prevent interrupt from being issued but does not override the ILIM behavior itself. ILIM value can be programmed dynamically through the I²C by the host.

7.3.8 Protection Mechanisms

7.3.8.1 Input Overvoltage Protection

The input overvoltage protection protects the device and downstream components connected to SYS, and BAT against damage from overvoltage on the input supply. When $V_{IN} > V_{IN_OVP}$, a VIN overvoltage condition is determined to exist. During the VIN overvoltage condition, the device turns the battery discharge FET on, sends a single 128- μ s pulse on INT, and the fault bit (VIN_OVP_FAULT_FLAG) is updated over I²C. The VIN_PGOOD_STAT bit also is affected by VIN overvoltage condition as the VIN powergood condition will fail. For a persisting OVP fault- even after clear on read- the OVP bit will be set right away. Once the VIN overvoltage condition is removed, the VIN_OVP_FAULT_FLAG fault bit is cleared and the device returns to normal operation. Thereafter VIN powergood condition is determined if $V_{IN} > V_{BAT} + V_{SLEEP}$.

7.3.8.2 Battery Undervoltage Lockout

To prevent deep discharge of the battery, the device integrates a battery undervoltage lockout feature that disengages the BAT to SYS path when voltage at the battery drops below the programmed BUVLO voltagesetting present in the CHARGERCTRL1 register. BUVLO status can also be read when a valid voltage on VIN is present.

7.3.8.3 Battery Overcurrent Protection

In order to protect the device from overcurrent and prevent excessive battery discharge current, the device detects if the current on the battery FET exceeds IBAT_OCP. If the BATOCP limit is reached, the battery discharge FET is turned off and the device starts operating in hiccup mode, re-enabling the BATFET t_{REC_SC} (250 ms) after being turned OFF by the over current condition. If the overcurrent condition is triggered upon retry for 4 to 7 consecutive times in a 2-s window, the BATFET shall then remain off until valid VIN is connected ($V_{IN} = V_{IN_POWERGOOD}$). If the overcurrent condition and hiccup operation occurs while in supplement mode where VIN is already present, VIN must be toggled in order for BATFET to be enabled and start another detection cycle.

7.3.8.4 System Overvoltage Protection

The system overvoltage protection is to prevent the SYS from overshooting to a high voltage due to the input supply. The SYS_OVP will momentarily disconnect the blocking FETs and re-engage when the thresholds have dropped to less than SYS_OVP_FALLING threshold.

The SYS_OVP_RISING threshold is typically 120% of the target SYS voltage and the SYS_OVP_FALLING threshold is 117% of the target SYS voltage.

7.3.8.5 System Short Protection

System short protection kicks in when the following conditions are met - the adapter connected the device turns ON the input FET for 5 ms and it detects the SYS pin to be shorted (voltage on SYS $< V_{\text{SYS_SHORT}}$). In this scenario, the device will turn OFF the input FET for 200 μs and turn it back ON for 5 ms for SYS to rise above the V_{SYSSHORT} threshold. If after 10 tries, the voltage at SYS does not rise above the V_{SYSSHORT} threshold, the device will disable both the input and BATFET paths and wait on adapter insertion before turning the paths ON again. A 2s timer is implemented to refresh the retry counter. After 2s, the device will check for system short again repeating the 10 attempts if there is a system short. The device should allow BATFET to supplement SYS during the 10 attempts to identify a short.

7.3.8.6 Thermal Protection and Thermal Regulation

During operation, to protect the device from damage due to overheating, the junction temperature of the die, T_J , is monitored. When T_J reaches $T_{\text{SHUT_RISING}}$ the device stops charging operation and V_{SYS} is shutdown. In the case where $T_J > T_{\text{SHUT_RISING}}$ prior to power being applied to the device (either battery or adapter), the input FET or BATFET will not turn ON, regardless of TSMR pin. Thereafter if temperature falls below $T_{\text{SHUT_FALLING}}$ the device will automatically power up if VIN is present or if in Battery Only mode.

Thermal considerations such as input voltage, charge current, and system load should be taken into account when designing the charging system. It should not be designed such that the device not regularly reaches T_{SHUT} . Rather, device junction temperature should be limited to the [Recommended Operating Temperature conditions](#).

During the charging process, to prevent overheating in the device, the device monitors the junction temperature of the die and reduces the charging current once T_J reaches the thermal regulation threshold (T_{REG}) based on bits set by THERM_REG setting. If the charge current is reduced to 0, the battery supplies the current needed to supply the SYS output.

To ensure that the system power dissipation is under the limit of the device. The power dissipated by the device can be calculated using the following equation:

$P_{\text{DISS}} = P_{\text{SYS}} + P_{\text{BAT}}$ Where:

$$P_{\text{SYS}} = (V_{\text{IN}} - V_{\text{SYS}}) * I_{\text{IN}}$$

$$P_{\text{BAT}} = (V_{\text{SYS}} - V_{\text{BAT}}) * I_{\text{BAT}}$$

The die junction temperature, T_J , can be estimated based on the expected board performance using the following equation:

$$T_J = T_A + \theta_{\text{JA}} * P_{\text{DISS}}$$

The θ_{JA} is largely driven by the board layout, board layers, copper thickness and the layout. For more information about traditional and new thermal metrics, see the [IC Package Thermal Metrics Application Report](#). Under typical conditions, the time spent in this state is very short.

7.3.8.7 Safety Timer and Watchdog Timer

At the beginning of each charge cycle mode (Precharge or Fast Charge), the device starts the respective mode safety timer. If charging has not terminated before the programmed safety time, t_{MAXCHG} expires or the device does not exit the precharge mode before t_{PRECHG} expires, charging is disabled. The precharge safety timer, t_{PRECHG} , is 25% of t_{MAXCHG} . When a safety timer fault occurs, a single 128- μs pulse is sent to the /INT pin and the STAT and FAULT bits of the status registers are updated. The charge enable bit or the input power must be toggled in order to clear the safety timer.

If the safety timer has expired, the device will produce an interrupt and update the SAFETY_TMR_FAULT_FLAG bit on the register map. The safety timer duration is programmable using the SAFETY_TIMER_1:0 bits. When the safety timer is active, changing the safety timer duration resets the safety timer. The device also contains a

2XTMR_EN bit that doubles the safety timer duration to prevent premature safety timer expiration when the charge current is reduced by a high load on SYS (DPM operation- causing VDPPM to be enabled), VINDPM, thermal regulation, or a NTC (JEITA) condition. When 2XTMR_EN bit is set, the timer is allowed to run at half speed when any loop is active other than CC or CV. If the charge current is reduced by pre-charge or TS_Cool then 2XTMR_EN has no effect and the safety timer runs at normal speed. Input sources that can't provide sufficient current even at a significantly lowered charge current may not be operating properly so it is safest to not double safety timer duration. In the event where during CC mode the battery voltage drops to push the charger into precharge mode, (due to a large load on battery, thermal events, and so forth) the safety timer will reset counting through precharge and then resetting the fast charge safety timer. If the device entered battery supplement mode while in precharge, CC or CV mode, while the charger is not disabled, the device will suspend the safety timer till the charging can resume back again. This prevents the safety timer from resetting when a supplement condition is caused.

In addition to the safety timer, the device contains a watchdog timer that monitors the host through the I²C interface. The watchdog timer is enabled by default and may be disabled by the host through an I²C transaction. Once the initial transaction is received, the watchdog timer is started. The watchdog timer is reset by any transaction by the host using the I²C interface. If the watchdog timer expires without a reset from the I²C interface, all R/W registers are reset to the default values. Watchdog timer can be set through the WATCHDOG_SEL_1:0 bits either on battery only mode or when adapter is present.

7.3.9 Pushbutton Wake and Reset Input

The pushbutton function implemented through TS/MR pin has three main functions. First, it serves as a means to wake the device from ultra-low power modes like Factory mode. Second, it serves as a short button press detector, sending an interrupt to the host when the button driving the TSMR pin has been pressed for a Wake1, Wake2 or long press durations. This allows the implementation of different functions in the end application such as menu selection and control. Finally it serves as a mean to get device into , Shutdown mode, or reset the system by performing a power cycle (shut down SYS and automatically powering it back on) after detecting a long button press. The timing for the short and long button press duration is programmable through I²C for added flexibility and allows system designers to customize the end user experience of a specific application. Note that if a specific timer duration is changed through I²C while that timer is active and has not expired, the new programmed value will be ignored until the timer expires and/or is reset by /MR.

7.3.9.1 Pushbutton Wake or Short Button Press Functions

There are two programmable wake or short button press timers, Wake1 and Wake2. There are no specific actions taken by the t_{wake1} or t_{wake2} durations other than issuing an interrupt and updating the MR_WAKE registers. For a wake from ship mode event , the push button has to be low for $t_{shipwake}$ before it can turn ON the SYS rail. This only applies to ship mode; a button press that pulls the TS/MR pin low for a duration $t_{shipwake}$ will not turn on the SYS rail when the device is in shutdown mode.

In the case where a valid V_{IN} ($V_{IN} > V_{UVLO}$) is connected prior to $t_{shipwake}$ timer expiring, the device will exit the shipmode immediately regardless of the TS/MR or wake timer state. V_{IN} should remain valid for t_{VIN_WAKE} to allow for a proper shipmode exit. Refer to [セクション 7.5](#) for more details.

The EN_PUSH bit will enable the button checking event through the periodic wake up of the current source on the TSMR pin. The timing will be similar to when in shipmode. When this bit is enabled all button events such as Wake1, Wake2 and MR_LPRESS events are valid. When this function is disabled, the button events are ignored. When the adapter is present and charging is actively in progress, this bit status is ignored as the current source is ON/ OFF when the NTC is being checked.

7.3.9.2 Pushbutton Reset or Long Button Press Functions

Depending on the configuration set on pushbutton long press action register bits, the device will perform a ship mode entry, shutdown mode entry, or hardware reset or completely ignore the long button press action. Toggling the /CE pin will restart the timer for the long press button when VIN is present.

To wake up the device from ship mode, there are two methods: a valid VIN power up or holding the TS/MR button for a time $t_{SHIPWAKE}$.

7.3.10 15-Second Timeout for HW Reset

Based on the I²C register bit WATCHDOG_15S_ENABLE the device can perform HW reset/power cycle in the same manner a long button press or HW_RESET would. This 15-second watchdog or timeout is gated upon $V_{IN} > V_{VBAT} + V_{SLEEP}$ so that the HW reset would only occur if the host does not respond after a charger is connected and the

If the charger is connected and the host responds before the 15-second watchdog expires, the part continues in normal operation and starts the normal 50-second watchdog timer if enabled. The 15-second watchdog may be enabled/ disabled through I²C through the WATCHDOG_15S_ENABLE bit.

7.3.11 Hardware Reset

The device is capable of hardware reset to completely powercycle the system. This is particularly useful when a soft reset on the MCU or host fails to work. A hardware reset needs to be possible in all SYS MODES.

There are a few ways a hardware reset occurs. A hardware reset will occur when:

1. The HW_RESET clock expires when the WATCHDOG_SEL is set to 0b01 or 0b10
2. No I2C transaction occurs when VIN is plugged in when the WATCHDOG_15_SENABLE is set to 0b1 within 15s
3. EN_RST_SHIP is set to 2b11
4. PB_LPRESS_ACTION is set to 2b11 and the button has been pressed for a duration set by MR_LP_LPRESS

Below is a sequence of events during a hardware reset:

1. Turn OFF (if adapter is present) input FET
2. Turn OFF battery FET
3. Engage pulldown on SYS
4. Start the Autowake timer
5. Once the Autowake timer expires, disconnect the pulldown on SYS
6. Reset all registers to default (as in new power up)
7. Turn ON battery FET and input FET (if applicable).

At a time t_{RESET_WARN} before the reset pulldown on SYS occurs, an interrupt occurs to signify a hardware reset is about to occur.

7.3.12 Software Reset

When a software reset is issued either through the watchdog action configurable through WATCHDOG_SEL bits or register reset configurable through REG_RST bit, the device will reset all the registers to defaults.

7.3.13 Interrupt Indicator (/INT) Pin

The device contains an open-drain output that signals its status and is valid only after the device has completed start-up into a valid state. If the part starts into a fault, interrupts will not be sent.

The /INT pin is normally in high impedance and is pulled low for 128 μ s when an interrupt condition occurs. When a fault or status change occurs or any other condition that generates an interrupt, a 128- μ s pulse (/INT pin pulled down) is sent on /INT to notify the host.

Interrupts can be masked through I²C. If the interrupt condition occurs while the interrupt is masked an interrupt pulse will not be sent. If the interrupt is unmasked while the fault condition is still present, an interrupt pulse will not be sent until the /INT trigger condition occurs while unmasked. Below are a list of interrupts that can be masked through I²C.

表 7-5. Mask Bit

MASK BIT	ACTION
ILIM_INT_MASK	Do not issue an /INT pulse when ILIM limiting occurs
DPM_INT_MASK	Do not issue an /INT pulse when VINDPM is active or VDPPM
TS_INT_MASK	Do not issue an /INT pulse when any of the TS events have occurred.
TREG_INT_MASK	Do not issue an /INT pulse when TREG is actively reducing the current
BAT_INT_MASK	Do not issue an /INT pulse when BATOCP or BUVLO event is triggered
CHG_STATUS_INT_MASK	Do not send an interrupt anytime there is a charging status change.

7.3.14 External NTC Monitoring (TS)

7.3.14.1 TS Biasing and Function

The device is configured to meet JEITA requirements ora simpler HOT/COLD function only. Additionally, the TS charger control function can be disabled through the TS_EN bit. This will only disable the TS charge action but the faults are still reported based on the TS voltage. To satisfy the JEITA requirements, four temperature thresholds are monitored: the cold battery threshold, the cool battery threshold, the warm battery threshold, and the hot battery threshold. These temperatures correspond to the V_{COLD} , V_{COOL} , V_{WARM} , and V_{HOT} thresholds in the Electrical Characteristics table. Charging and safety timers are suspended when $V_{TS} < V_{HOT}$ or $V_{TS} > V_{COLD}$. When $V_{COOL} < V_{TS} < V_{COLD}$, the charging current is reduced to the value programmed in the TS_Setting register/ bit TS_ICHG_0. When $V_{HOT} < V_{TS} < V_{WARM}$, the battery regulation voltage is reduced by 100 mV or 200 mV based on the value programmed in TS_VRCG_0 bit within the TS_Setting register.

For devices where the TS function is not needed, tie a 10-kΩ resistor to the TS/MR pin.

There is an active voltage clamp present on this device which will prevent the voltage on TS/MR pin from rising above the V_{TS_CLAMP} threshold. This will particularly be ON when the TS/MR pin is floating. The bit TS_OPEN_STAT is set when this clamp is active. This will also be ON regardless of the TS_EN bit. The interrupt is asserted as long as the TS_INT mask is not written.

The bits TS_HOT, TS_COLD, TS_WARM and TS_COOL will allow these thresholds to be adjusted slightly. The hysteresis will also move along with these thresholds. When the TS_WARM condition occurs, the device will lower the battery target regulation voltage by TS_VRCG but will not modify the VBAT_CTRL register.

The TS_ICHG bit will reduce charging current based on the factor described in the register map when the TSMR pin hits a TS_COOL condition. The TREG function will still be based on this reduced threshold.

The TS_VRCG_0 bit will reduce the charging voltage when the TS/MR pin hits the TS_WARM threshold. The factor will be based on the register map.

When the button is detected as a “press” during the charging process, charging will be momentarily suspended until the button is high again. When charging is disabled in any of the TS faults, the trickle charging is also disabled. In a TS fault where the current is reduced (COOL), the trickle charging current is not altered.

7.3.15 I²C Interface

The device uses an I²C compatible interface to program and read control parameters, status bits, etc. I²C™ is a 2-wire serial interface developed by Philips Semiconductor (see I²C-Bus Specification, Version 2.1, January 2000). The bus consists of a data line (SDA) and a clock line (SCL) with pull-up structures. When the bus is idle, both SDA and SCL lines are pulled high. All the I²C compatible devices connect to the I²C bus through open drain I/O pins, SDA and SCL. A master device, usually a microcontroller or a digital signal processor, controls the bus. The master is responsible for generating the SCL signal and device addresses. The master also generates specific conditions that indicate the START and STOP of data transfer. A slave device receives and/or transmits data on the bus under control of the master device.

The device works as a peripheral and supports the following data transfer modes, as defined in the I²C Bus™ Specification: standard mode (100 kbps) and fast mode (400 kbps). The interface adds flexibility to the battery charge solution, enabling most functions to be programmed to new values depending on the instantaneous application requirements.

Register contents remain intact as long as V_{BAT} or V_{IN} voltages remains above their respective undervoltage lockout thresholds and the device is not in shutdown mode.

The data transfer protocol for standard and fast modes is exactly the same; therefore, they are referred to as the F/S-mode in this document. The device only supports 7-bit addressing. The device 7-bit address is 0x6A (8-bit shifted address is 0xD4).

7.3.15.1 F/S Mode Protocol

The master initiates data transfer by generating a start condition. The start condition is when a high-to-low transition occurs on the SDA line while SCL is high, as shown in [Figure 7-4](#). All I²C-compatible devices should recognize a start condition.

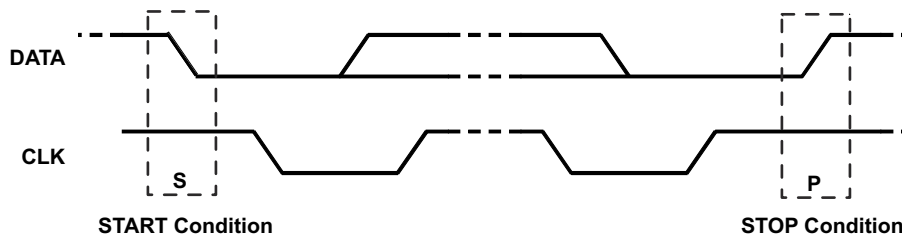

Figure 7-4. START and STOP Condition

The master then generates the SCL pulses, and transmits the 8-bit address and the read/write direction bit R/W on the SDA line. During all transmissions, the master ensures that data is valid. A valid data condition requires the SDA line to be stable during the entire high period of the clock pulse (see [Figure 7-5](#)). All devices recognize the address sent by the master and compare it to their internal fixed addresses. Only the slave device with a matching address generates an acknowledge (see [Figure 7-6](#)) by pulling the SDA line low during the entire high period of the ninth SCL cycle. Upon detecting this acknowledge, the master knows that communication link with a slave has been established.

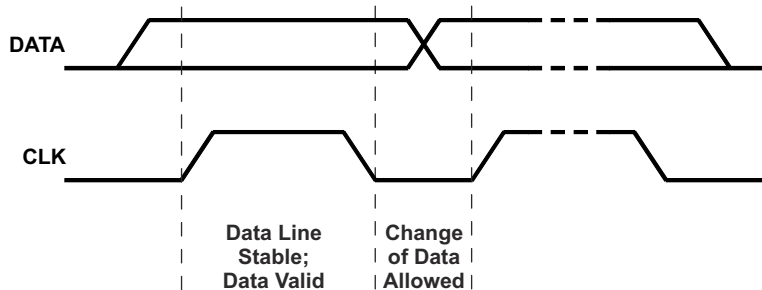

Figure 7-5. Bit Transfer on the Serial Interface

The master generates further SCL cycles to either transmit data to the slave (R/W bit 1) or receive data from the slave (R/W bit 0). In either case, the receiver needs to acknowledge the data sent by the transmitter. So an acknowledge signal can either be generated by the master or by the slave, depending on which one is the receiver. The 9-bit valid data sequences consisting of 8-bit data and 1-bit acknowledge can continue as long as necessary. To signal the end of the data transfer, the master generates a stop condition by pulling the SDA line from low to high while the SCL line is high (see [Figure 7-4](#)). This releases the bus and stops the communication link with the addressed slave. All I²C compatible devices must recognize the stop condition. Upon the receipt of a stop condition, all devices know that the bus is released, and wait for a start condition followed by a matching address. If a transaction is terminated prematurely, the master needs sending a STOP condition to prevent the

slave I²C logic from remaining in an incorrect state. Attempting to read data from register addresses not listed in this section will result in FFh being read out.



図 7-6. Acknowledge on the I²C Bus



図 7-7. Bus Protocol

7.4 Device Functional Modes

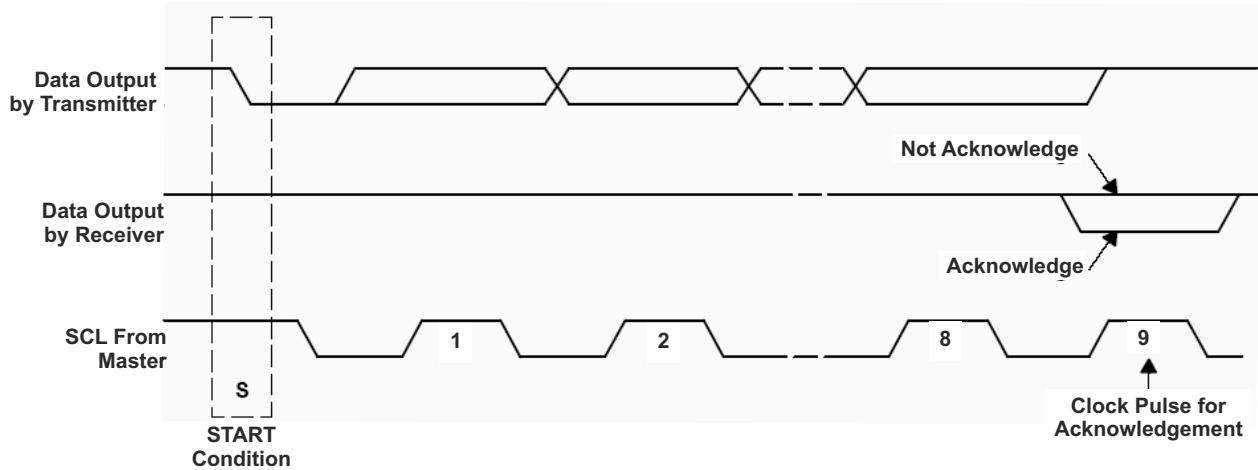
The BQ21088 has four main modes of operation: Charger/Adapter Mode (when a supply is connected to IN), Battery Mode (when only battery is connected), Ship Mode, and Shutdown Mode. The table below summarizes the functions that are active for each operation mode.

表 7-6. Device Functional Modes

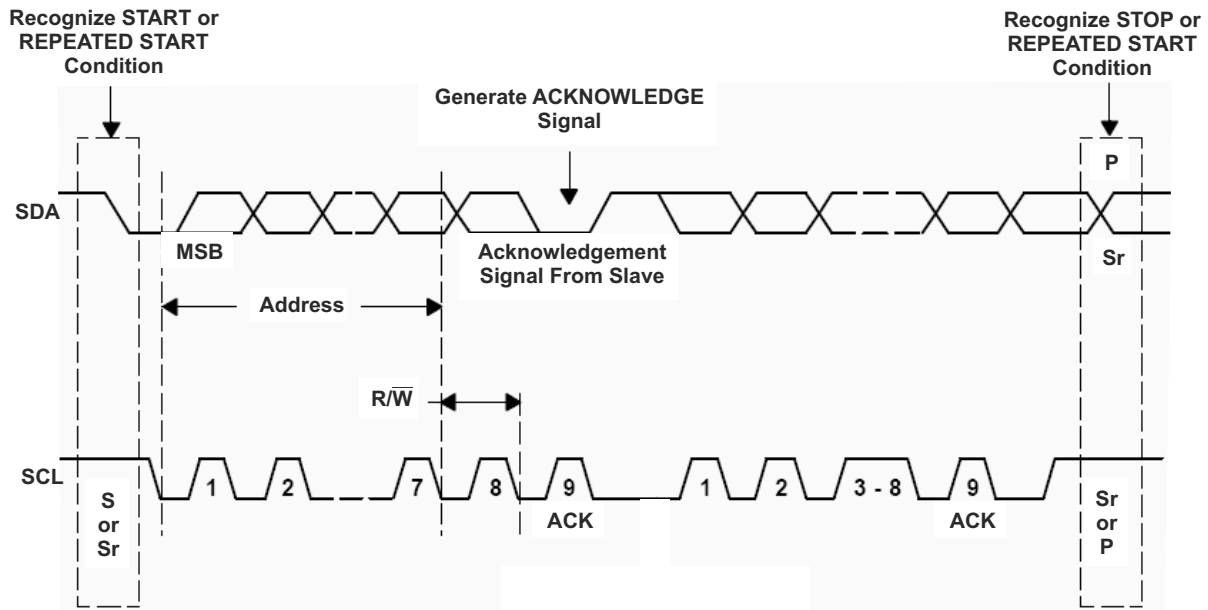
FUNCTION	CHARGER/ADAPTER MODE	BATTERY MODE	SHIP MODE	SHUTDOWN MODE
Input Overvoltage	Yes	Yes	No	No
Input Undervoltage	Yes	Yes	Yes	Yes
Battery Overcurrent	Yes	Yes	Yes	No

表 7-6. Device Functional Modes (続き)

FUNCTION	CHARGER/ADAPTER MODE	BATTERY MODE	SHIP MODE	SHUTDOWN MODE
Input DPM	Yes	No	Yes	No
Dynamic Power Path Management	Yes	No	No	No
BATFET	Yes	Yes	No	No
TS Measurement	Yes	No	No	No
Battery Charging	Yes	No	No	No
Input Current Limit	Yes	No	No	No
Pushbutton Input	Yes	No	No	No

7.5 Register Maps

7.5.1 I²C Registers

表 7-7 lists the I²C registers. All register offset addresses not listed in 表 7-7 should be considered as reserved locations and the register contents should not be modified.

表 7-7. I²C Registers

Offset	Acronym	Register Name	Section
0x0	STAT0	Charger Status	Go
0x1	STAT1	Charger Status and Faults	Go
0x2	FLAG0	Charger Flag Registers	Go
0x3	VBAT_CTRL	Battery Voltage Control	Go
0x4	ICHG_CTRL	Fast Charge Current Control	Go
0x5	CHARGECTRL0	Charger Control 0	Go
0x6	CHARGECTRL1	Charger Control 1	Go
0x7	IC_CTRL	IC Control	Go
0x8	TMR_ILIM	Timer and Input Current Limit Control	Go
0x9	SHIP_RST	Shipmode, Reset and Pushbutton Control	Go
0xA	SYS_REG	SYS Regulation Voltage Control	Go
0xB	TS_CONTROL	TS Control	Go
0xC	MASK_ID	MASK and Device ID	Go

Complex bit access types are encoded to fit into small table cells. 表 7-8 shows the codes that are used for access types in this section.

表 7-8. I²C Access Type Codes

Access Type	Code	Description
Read Type		
R	R	Read
RC	RC	Read to Clear
Write Type		
W	W	Write
Reset or Default Value		
- n		Value after reset or the default value

7.5.1.1 STAT0 Register (Offset = 0x0) [Reset = X]

STAT0 is shown in [図 7-8](#) and described in [表 7-9](#).

Return to the [Summary Table](#).

図 7-8. STAT0 Register

7	6	5	4	3	2	1	0
TS_OPEN_STAT	CHG_STAT_1:0		ILIM_ACTIVE_STAT	VDPPM_ACTIVE_STAT	VINDPM_ACTIVE_STAT	THERMREG_ACTIVE_STAT	VIN_PGOOD_STAT
R-X	R-X		R-X	R-X	R-X	R-X	R-X

表 7-9. STAT0 Register Field Descriptions

Bit	Field	Type	Reset	Description
7	TS_OPEN_STAT	R	X	TS Open Status (Clamp is active) 1b0 = TSMR pin is not Open 1b1 = TSMR pin is Open or $V_{BAT} < V_{BAT_HALT}$.
6-5	CHG_STAT_1:0	R	X	Charging Status Indicator 2b00 = Not Charging while charging is enabled. 2b01 = Constant Current Charging (Trickle Charge/ Pre Charge or in Fast Charge Mode) 2b10 = Constant Voltage Charging 2b11 = Charge Done or charging is disabled by the host.
4	ILIM_ACTIVE_STAT	R	X	Input Current Limit Active 1b0 = Not Active 1b1 = Active
3	VDPPM_ACTIVE_STAT	R	X	VDPPM Mode Active 1b0 = Not Active 1b1 = Active
2	VINDPM_ACTIVE_STAT	R	X	VINDPM Mode Active 1b0 = Not Active 1b1 = Active
1	THERMREG_ACTIVE_STAT	R	X	Thermal Regulation Active 1b0 = Not Active 1b1 = Active
0	VIN_PGOOD_STAT	R	X	VIN Power Good 1b0 = VIN Power Not Good 1b1 = VIN Power Good

7.5.1.2 STAT1 Register (Offset = 0x1) [Reset = X]

STAT1 is shown in [図 7-9](#) and described in [表 7-10](#).

Return to the [Summary Table](#).

図 7-9. STAT1 Register

7	6	5	4	3	2	1	0
VIN_OVP_STAT	BUVLO_STAT	RESERVED	TS_STAT_1:0		SAFETY_TMR_FAULT_FLAG	WAKE1_FLAG	WAKE2_FLAG
R-1b0	R-X	R-X	R-2b00		RC-1b0	RC-1b0	RC-1b0

表 7-10. STAT1 Register Field Descriptions

Bit	Field	Type	Reset	Description
7	VIN_OVP_STAT	R	1b0	VIN_OVP Status 1b0 = Not Active 1b1 = Active
6	BUVLO_STAT	R	X	Battery UVLO Status 1b0 = Not Active 1b1 = Active
4-3	TS_STAT_1:0	R	2b00	TS Status 2b00 = Normal 2b01 = VTS < VHOT or VTS > VCOLD(charging suspended) 2b10 = VCOOL < VTS < VCOLD (Charging current reduced by value set by TS_Registers) 2b11 = VWARM > VTS > VHOT (Charging voltage reduced by value set by TS_Registers)
2	SAFETY_TMR_FAULT_FLAG	RC	1b0	Safety Timer Expired Fault Cleared only after CE is toggled. 1b0 = Not Active 1b1 = Active
1	WAKE1_FLAG	RC	1b0	Wake 1 Timer Flag 1b0 = Does not meet Wake 1 Condition 1b1 = Met Wake 1 Condition
0	WAKE2_FLAG	RC	1b0	Wake 2 Timer Flag 1b0 = Does not meet Wake 2 Condition 1b1 = Met Wake2 Condition

7.5.1.3 FLAG0 Register (Offset = 0x2) [Reset = X]

FLAG0 is shown in [図 7-10](#) and described in [表 7-11](#).

Return to the [Summary Table](#).

図 7-10. FLAG0 Register

7	6	5	4	3	2	1	0
TS_FAULT	ILIM_ACTIVE_FLAG	VDPPM_ACTIVE_FLAG	VINDPM_ACTIVE_FLAG	THERMREG_ACTIVE_FLAG	VIN_OVP_FAULT_FLAG	BUVLO_FAULT_FLAG	BAT_OCP_FAULT
RC-X	RC-X	RC-X	RC-X	RC-X	RC-X	RC-X	RC-X

表 7-11. FLAG0 Register Field Descriptions

Bit	Field	Type	Reset	Description
7	TS_FAULT	RC	X	TS_Fault 1b0 = No TS Fault detected 1b1 = TS Fault detected
6	ILIM_ACTIVE_FLAG	RC	X	ILIM Active 1b0 = NO ILIM Fault detected 1b1 = ILIM Fault detected
5	VDPPM_ACTIVE_FLAG	RC	X	VDPPM FLAG 1b0 = VDPPM fault not detected 1b1 = VDPPM fault detected
4	VINDPM_ACTIVE_FLAG	RC	X	VINDPM FLAG 1b0 = VINDPM fault not detected 1b1 = VINDPM fault detected
3	THERMREG_ACTIVE_FLAG	RC	X	Thermal Regulation FLAG 1b0 = No thermal regulation detected 1b1 = Thermal regulation has occurred
2	VIN_OVP_FAULT_FLAG	RC	X	VIN_OVP FLAG 1b0 = VIN_OVP fault not detected 1b1 = VIN_OVP fault detected
1	BUVLO_FAULT_FLAG	RC	X	Battery undervoltage FLAG 1b0 = Battery undervoltage fault not detected 1b1 = Battery undervoltage fault detected
0	BAT_OCP_FAULT	RC	X	Battery overcurrent protection 1b0 = Battery overcurrent condition not detected 1b1 = Battery overcurrent condition detected

7.5.1.4 VBAT_CTRL Register (Offset = 0x3) [Reset = 0x46]

VBAT_CTRL is shown in [図 7-11](#) and described in [表 7-12](#).

Return to the [Summary Table](#).

図 7-11. VBAT_CTRL Register

7	6	5	4	3	2	1	0
RESERVED	VBATREG_6:0						
R/W-1b0	R/W-7b1000110						

表 7-12. VBAT_CTRL Register Field Descriptions

Bit	Field	Type	Reset	Description
7	PG_MODE	R/W	1b0	PG_GPO pin as GPO 1b0 = PG_GPO as a status of VIN (Power Good) 1b1 = PG_GPO as a general-purpose output pin (GPO)
6-0	VBATREG_6:0	R/W	7b1000110	Battery Regulation Voltage VBATREG= 3.5V + VBATREG_CODE * 10mV. Maximum programmable voltage = 4.65V

7.5.1.5 ICHG_CTRL Register (Offset = 0x4) [Reset = 0x5]

ICHG_CTRL is shown in [図 7-12](#) and described in [表 7-13](#).

Return to the [Summary Table](#).

図 7-12. ICHG_CTRL Register

7	6	5	4	3	2	1	0
CHG_DIS	ICHG_6:0						
R/W-1b0	R/W-7b0000101						

表 7-13. ICHG_CTRL Register Field Descriptions

Bit	Field	Type	Reset	Description
7	CHG_DIS	R/W	1b0	Charge Disable 1b0 = Battery Charging Enabled 1b1 = Battery Charging Disabled
6-0	ICHG_6:0	R/W	7b0000101	For ICHG ≤ 35mA = ICHGCODE +5mA For ICHG > 35mA = 40+ ((ICHGCODE-31)*10)mA. Maximum programmable current = 1000mA

7.5.1.6 CHARGECTRL0 Register (Offset = 0x5) [Reset = 0x24]

CHARGECTRL0 is shown in [図 7-13](#) and described in [表 7-14](#).

Return to the [Summary Table](#).

図 7-13. CHARGECTRL0 Register

7	6	5	4	3	2	1	0
RESERVED	IPRECHG	ITERM_1:0		VINDPM_1:0		THERM_REG_1:0	
R/W-1b0	R/W-1b0	R/W-2b10		R/W-2b01		R/W-2b00	

表 7-14. CHARGECTRL0 Register Field Descriptions

Bit	Field	Type	Reset	Description
7	EN_FC_MODE	R/W	1b0	Enable or disable Flash Charging mode 1b0 = Disable 1b1 = Enable
6	IPRECHG	R/W	1b0	Precharge current = x times of term 1b0 = Precharge is 2x Term 1b1 = Precharge is Term
5-4	ITERM_1:0	R/W	2b10	Termination current = % of Icharge 2b00 = Disable 2b01 = 5% of ICHG 2b10 = 10% of ICHG 2b11 = 20% of ICHG
3-2	VINDPM_1:0	R/W	2b11	VINDPM Level Selection 2b00 = VBAT + 300 mV. 2b01 = 4.5 V 2b10 = 4.7 V 2b11 = Disabled
1-0	THERM_REG_1:0	R/W	2b00	Thermal Regulation Threshold 2b00 = 100C 2b01 = 80C 2b10 = 60C 2b11 = Disabled

7.5.1.7 CHARGECTRL1 Register (Offset = 0x6) [Reset = 0x56]

CHARGECTRL1 is shown in [図 7-14](#) and described in [表 7-15](#).

Return to the [Summary Table](#).

図 7-14. CHARGECTRL1 Register

7	6	5	4	3	2	1	0
IBAT_OCP_1:0		BUVLO_2:0			CHG_STATUS_INT_MASK	ILIM_INT_MASK	VINDPM_INT_MASK
R/W-2b01		R/W-3b010			R/W-1b1	R/W-1b1	R/W-1b0

表 7-15. CHARGECTRL1 Register Field Descriptions

Bit	Field	Type	Reset	Description
7-6	IBAT_OCP_1:0	R/W	2b01	Battery Discharge Current Limit 2b00 = 500mA 2b01 = 1000mA 2b10 = 1500mA 2b11 = 3000mA
5-3	BUVLO_2:0	R/W	3b010	Battery Undervoltage LockOut Threshold Falling (150mV Hist). 3b000 = 3.0V 3b001 = 3.0V 3b010 = 3.0V 3b011 = 2.8V 3b100 = 2.6V 3b101 = 2.4V 3b110 = 2.2V 3b111 = 2.0V
2	CHG_STATUS_INT_MASK	R/W	1b1	Mask Charging Status Interrupt 1b0 = Enable Charging Status Interrupt anytime there is a charging status change. 1b1 = Mask Charging Status Interrupt
1	ILIM_INT_MASK	R/W	1b1	Mask ILIM Fault Interrupt 1b0 = Enable ILIM Interrupt 1b1 = Mask ILIM Interrupt
0	VINDPM_INT_MASK	R/W	1b0	Mask VINDPM Interrupt 1b0 = Enable VINDPM and DPPM Interrupt 1b1 = Mask VINDPM and DPPM Interrupt

7.5.1.8 IC_CTRL Register (Offset = 0x7) [Reset = 0x84]

IC_CTRL is shown in [図 7-15](#) and described in [表 7-16](#).

Return to the [Summary Table](#).

図 7-15. IC_CTRL Register

7	6	5	4	3	2	1	0
TS_EN	VLOWV_SEL	VRCH_0	2XTMR_EN	SAFETY_TIMER_1:0		WATCHDOG_SEL_1:0	
R/W-1b1	R/W-1b0	R/W-1b0	R/W-1b0	R/W-2b01		R/W-2b00	

表 7-16. IC_CTRL Register Field Descriptions

Bit	Field	Type	Reset	Description
7	TS_EN	R/W	1b1	TS Auto Function 1b0 = TS auto function disabled (Only charge control is disabled. TS monitoring is enabled) 1b1 = TS auto function enabled
6	VLOWV_SEL	R/W	1b0	Precharge Voltage Threshold (VLOWV) 1b0 = 3V 1b1 = 2.8V
5	VRCH_0	R/W	1b0	Recharge Voltage Threshold 1b0 = 100mV 1b1 = 200 mV
4	2XTMR_EN	R/W	1b0	Timer Slow 1b0 = The timer is not slowed at any time 1b1 = The timer is slowed by 2x when in any control other than CC or CV
3-2	SAFETY_TIMER_1:0	R/W	2b01	Fast Charge Timer 2b00 = 3 hour fast charge 2b01 = 6 hour fast charge 2b10 = 12 hour fast charge 2b11 = Disable safety timer
1-0	WATCHDOG_SEL_1:0	R/W	2b00	Watchdog Selection 2b00 = 160s default register values 2b01 = 160s HW_RESET 2b10 = 40s HW_RESET 2b11 = Disable watchdog function

7.5.1.9 TMR_ILIM Register (Offset = 0x8) [Reset = 0x4D]

TMR_ILIM is shown in [図 7-16](#) and described in [表 7-17](#).

Return to the [Summary Table](#).

図 7-16. TMR_ILIM Register

7	6	5	4	3	2	1	0
MR_LPRESS_1:0		MR_RESET_VI N	AUTOWAKE_1:0		ILIM_2:0		
R/W-2b01		R/W-1b0	R/W-2b01		R/W-3b101		

表 7-17. TMR_ILIM Register Field Descriptions

Bit	Field	Type	Reset	Description
7-6	MR_LPRESS_1:0	R/W	2b01	Push button Long Press duration timer 2b00 = 5s 2b01 = 10s 2b10 = 15s 2b11 = 20s
5	MR_RESET_VIN	R/W	1b0	Hardware reset condition 1b0 = HW Resets are not gated by VIN_PowerGood 1b1 = HW Resets require VIN_PowerGood
4-3	AUTOWAKE_1:0	R/W	2b01	Auto Wake Up Timer Restart 2b00 = 0.5s 2b01 = 1s 2b10 = 2s 2b11 = 4s
2-0	ILIM_2:0	R/W	3b101	Input Current Limit Setting (max) 3b000 = 50mA 3b001 = 100mA 3b010 = 200mA 3b011 = 300mA 3b100 = 400mA 3b101 = 500mA 3b110 = 665mA 3b111 = 1050mA

7.5.1.10 SHIP_RST Register (Offset = 0x9) [Reset = 0x11]

SHIP_RST is shown in [図 7-17](#) and described in [表 7-18](#).

Return to the [Summary Table](#).

図 7-17. SHIP_RST Register

7	6	5	4	3	2	1	0
REG_RST	EN_RST_SHIP_1:0		PB_LPRESS_ACTION_1:0		WAKE1_TMR	WAKE2_TMR	EN_PUSH
R/W-1b0	R/W-2b00		R/W-2b10		R/W-1b0	R/W-1b0	R/W-1b1

表 7-18. SHIP_RST Register Field Descriptions

Bit	Field	Type	Reset	Description
7	REG_RST	R/W	1b0	Software Reset 1b0 = Do nothing 1b1 = Software Reset
6-5	EN_RST_SHIP_1:0	R/W	2b00	Ship mode Enable and Hardware Reset 2b00 = Do nothing 2b01 = Enable shutdown mode 2b10 = Enable ship mode 2b11 = Hardware Reset
4-3	PB_LPRESS_ACTION_1:0	R/W	2b10	Pushbutton long press action 2b00 = Do nothing 2b01 = Hardware Reset 2b10 = Enable Ship mode. Ship mode can be exited by waking the device with a TSMR button press or adapter insertion 2b11 = Enable Shutdown Mode. Shutdown mode can be exited by an adapter insertion.
2	WAKE1_TMR	R/W	1b0	Wake 1 Timer Set 1b0 = 300ms 1b1 = 1s
1	WAKE2_TMR	R/W	1b0	Wake 2 Timer Set 1b0 = 2s 1b1 = 3s
0	EN_PUSH	R/W	1b1	Enable Push Button and Reset Functionality when in Active Battery 1b0 = Disable 1b1 = Enable

7.5.1.11 SYS_REG Register (Offset = 0xA) [Reset = 0x42]

SYS_REG is shown in [図 7-18](#) and described in [表 7-19](#).

Return to the [Summary Table](#).

図 7-18. SYS_REG Register

7	6	5	4	3	2	1	0
SYS_REG_CTRL_2:0			RESERVED	SYS_MODE_1:0		WATCHDOG_1 5S_ENABLE	VDPPM_DIS
R/W-3b010			R/W-1b0	R/W-2b00		R/W-1b0	R/W-1b0

表 7-19. SYS_REG Register Field Descriptions

Bit	Field	Type	Reset	Description
7-5	SYS_REG_CTRL_2:0	R/W	3b010	SYS Regulation Voltage 3b000 = Battery Tracking Mode 3b001 = 4.4V 3b010 = 4.5V 3b011 = 4.6V 3b100 = 4.7V 3b101 = 4.8V 3b110 = 4.9V 3b111 = Pass-Through (if OVP is 5.7 V) or 5.5 V (if OVP is 18.5 V)
4	PG_GPO	R/W	1b0	Power Good Logic Level 1b0 = PG_GPO is high impedance 1b1 = PG_GPO is low
3-2	SYS_MODE_1:0	R/W	2b00	Sets how SYS is powered in any state, except SHIPMODE 2b00 = SYS powered from VIN if present or VBAT (current def) 2b01 = SYS powered from VBAT only, even if VIN present 2b10 = SYS disconnected and left floating (VDD and digital are all still running. TSMR/ VIN would have to wake SYS) 2b11 = SYS disconnected with pulldown(VDD and digital are all still running. TSMR/VIN would have to wake SYS)
1	WATCHDOG_15S_ENABLE	R/W	1b0	I2C Watchdog 1b0 = Mode Disabled 1b1 = Do a HW reset after 15s if no I2C transaction after VIN plugged
0	VDPPM_DIS	R/W	1b0	Disable DPPM 1b0 = Enable DPPM 1b1 = Disable DPPM

7.5.1.12 TS_CONTROL Register (Offset = 0xB) [Reset = 0x0]

TS_CONTROL is shown in [図 7-19](#) and described in [表 7-20](#).

Return to the [Summary Table](#).

図 7-19. TS_CONTROL Register

7	6	5	4	3	2	1	0
TS_HOT		TS_COLD		TS_WARM	TS_COOL	TS_ICHG	TS_VRCG
R/W-2b00		R/W-2b00		R/W-1b0	R/W-1b0	R/W-1b0	R/W-1b0

表 7-20. TS_CONTROL Register Field Descriptions

Bit	Field	Type	Reset	Description
7-6	TS_HOT	R/W	2b00	TS Hot threshold register 2b00 = Default 60C 2b01 = 65C 2b10 = 50C 2b11 = 45C
5-4	TS_COLD	R/W	2b00	TS Cold threshold register 2b00 = Default 0C 2b01 = 3C 2b10 = 5C 2b11 = -3C
3	TS_WARM	R/W	1b0	TS Warm threshold register TS Warm threshold (Easy to push with Rs, favor low) 1b0 = Default 45C 1b1 = Disabled
2	TS_COOL	R/W	1b0	TS Cool threshold register (Easy to push with Rp, favor high) 1b0 = Default 10C 1b1 = Disabled
1	TS_ICHG	R/W	1b0	Fast charge current when decreased by TS function 1b0 = 0.5*ICHG 1b1 = 0.2*ICHG
0	TS_VRCG	R/W	1b0	Reduced target battery voltage during Warm 1b0 = VBATREG -100mV 1b1 = VBATREG -200mV

7.5.1.13 MASK_ID Register (Offset = 0xC) [Reset = 0x40]

MASK_ID is shown in [図 7-20](#) and described in [表 7-21](#).

Return to the [Summary Table](#).

図 7-20. MASK_ID Register

7	6	5	4	3	2	1	0
TS_INT_MASK	TREG_INT_MASK	BAT_INT_MASK	PG_INT_MASK	Device_ID			
R/W-1b0	R/W-1b1	R/W-1b0	R/W-1b0	R-4b0000			

表 7-21. MASK_ID Register Field Descriptions

Bit	Field	Type	Reset	Description
7	TS_INT_MASK	R/W	1b0	MASK_TS 1b0 = Enable TS Interrupt 1b1 = Mask TS Interrupt
6	TREG_INT_MASK	R/W	1b1	MASK_TREG 1b0 = Enable TREG Interrupt 1b1 = Mask TREG Interrupt
5	BAT_INT_MASK	R/W	1b0	MASK_BATOCP_BUVLO 1b0 = Enable BOCP or BUVLO Interrupt 1b1 = Mask BOCP or BUVLO Interrupt
4	PG_INT_MASK	R/W	1b0	MASK_PG 1b0 = Enable PG and VINOVP Interrupt 1b1 = Mask PG and VINOVP Interrupt
3-0	Device_ID	R	4b0100	Device ID

8 Application and Implementation

注

Information in the following applications sections is not part of the TI component specification, and TI does not warrant its accuracy or completeness. TI's customers are responsible for determining suitability of components for their purposes, as well as validating and testing their design implementation to confirm system functionality.

8.1 Application Information

A typical application of the BQ21088 consists of the device configured as an I²C controlled single cell Li-ion battery charger and power path manager or battery applications such as smart-watches and wireless headsets. A battery thermistor may be connected to the TS pin to allow the device to monitor the battery temperature and control charging as desired.

The system designer may connect the TS/MR pin input to a push-button to send interrupts to the host as a button is pressed or to allow the application end user to reset the system.

8.2 Typical Application



図 8-1. Typical Application

8.2.1 Application

8.2.2 Design Requirements

The design requirements for the following design example are shown in 表 8-1.

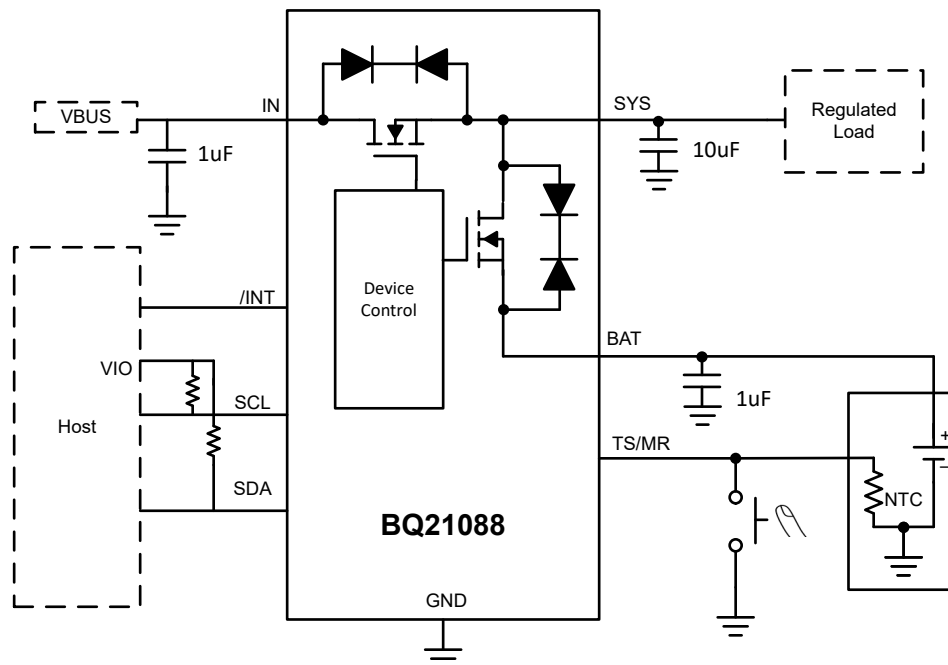
表 8-1. Design Parameters

PARAMETER	VALUE
IN Supply Voltage	5 V
Battery Regulation Voltage	4.2 V

8.2.3 Detailed Design Procedure

Input (IN/SYS) Capacitors

Low ESR ceramic capacitors such as X7R or X5R are preferred for input decoupling capacitors and should be placed as close as possible to the supply and ground pins for the IC. Due to the voltage derating of the capacitors, it is recommended that 35-V rated capacitors are used for the IN pin. Higher IN voltages can cause significant decrease in effective capacitance due to DC Bias derating. For output stability, it is important that the minimum capacitance after derating be higher than 1 μF for the operating input voltage.

TS

The ground connection for the NTC must be made as close as possible to the GND pin of the device or kelvin connected to it to minimize any error in TS measurement due to IR drops on the ground board lines.

If the system designer does not wish to use the TS function for charging control, a 10-k Ω resistor must be connected from TS to ground.

Recommended Passive Components

PARAMETER		MIN	NOM	MAX	UNIT
C _{SYS}	Capacitance on SYS pin	1	10	100	μF
C _{BAT}	Capacitance on BAT pin	1	1	-	μF
C _{IN}	IN input bypass capacitance (After DC Bias Derating)	1	1	10	μF

8.2.4 Application Curves

$C_{IN} = 1 \mu\text{F}$, $C_{OUT} = 10 \mu\text{F}$, $V_{IN} = 5 \text{ V}$, $V_{OUT} = 3.8 \text{ V}$, $I_{CHG} = 10 \text{ mA}$ (unless otherwise specified)

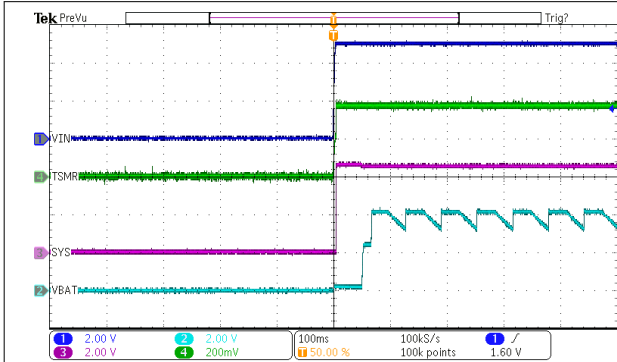

VIN = 5 V VBAT = Floating

8-2. Power Up with IN Supply Insertion with No Battery

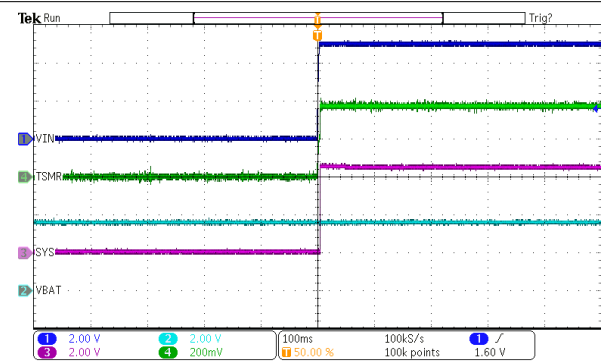

VIN = 5 V VBAT = 3.6 V

8-3. Power Up from Shutdown Mode with VIN Supply Insertion

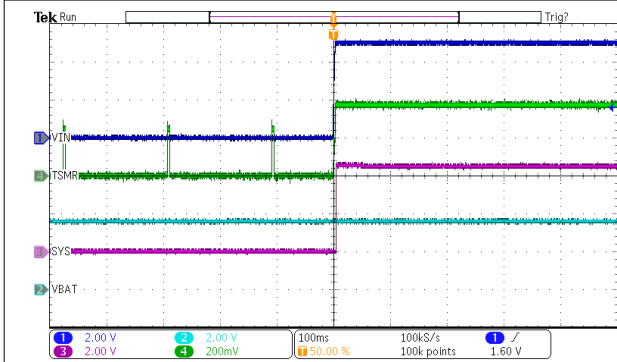

VIN = 0 V → 5 V VBAT = 3.8 V

8-4. Power Up from Shipmode with VIN Insertion

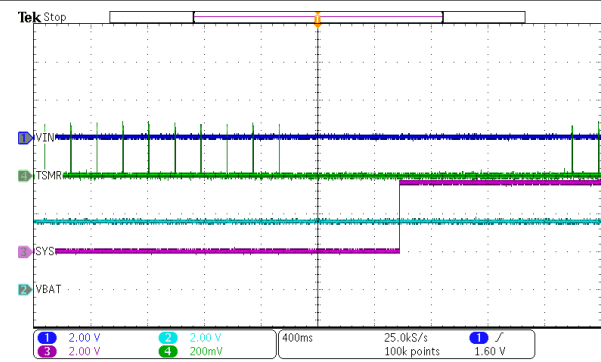

MR_LPRESS = 00 (5s Long Press Timer)

8-5. Power Up from Shipmode with /TSMR Button Press

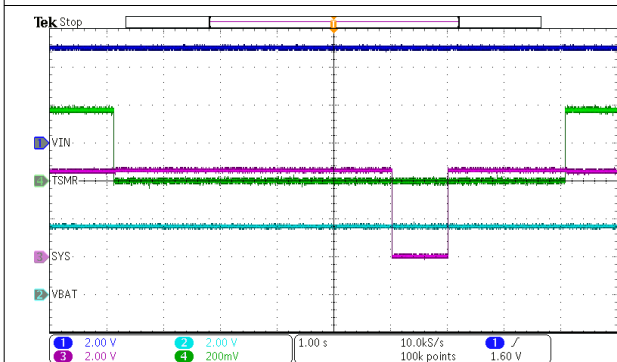

MR_LPRESS = 00 (5s Long Press Timer)
PB_LPRESS_ACTION = 01 (Hardware Reset)

8-6. Hardware Reset with /TSMR Press

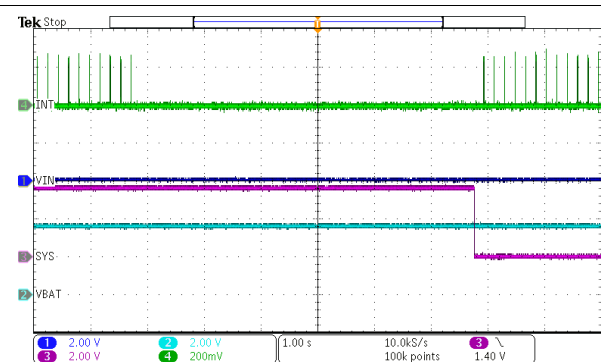

MR_LPRESS = 00 (5s Long Press Timer)
PB_LPRESS_ACTION = 10

8-7. Enter Shipmode with Push Button Long Press

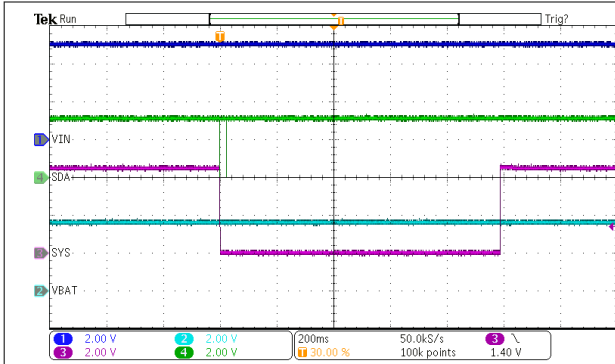

8-8. Hardware Reset Through I²C

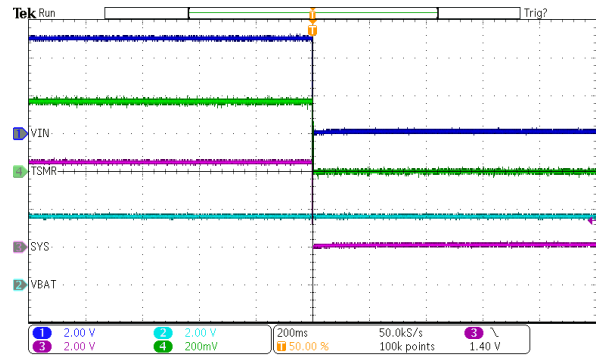

EN_RST_SHIP = 01 (enable shutdown with wake on adapter insert only)

8-9. Shutdown Entry on VIN Removal

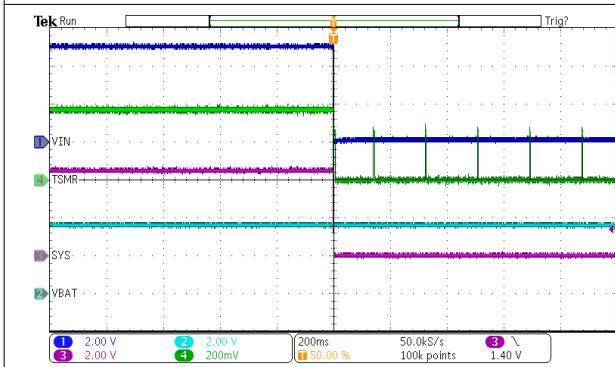

EN_RST_SHIP = 10 (enable shutdown with wake on adapter insert only)

8-10. Shipmode Entry on VIN Removal

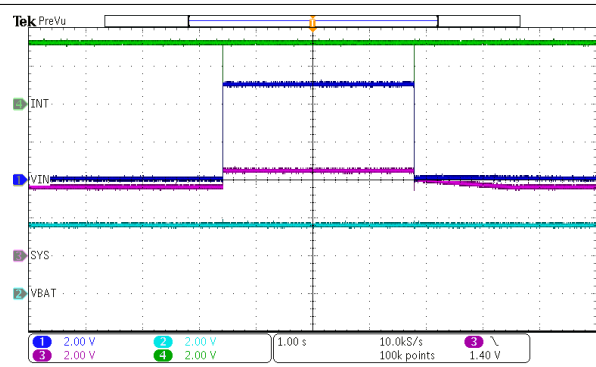

V_{IN} = 0 V → 5 V → 0 V

8-11. Power Good Interrupt on /INT

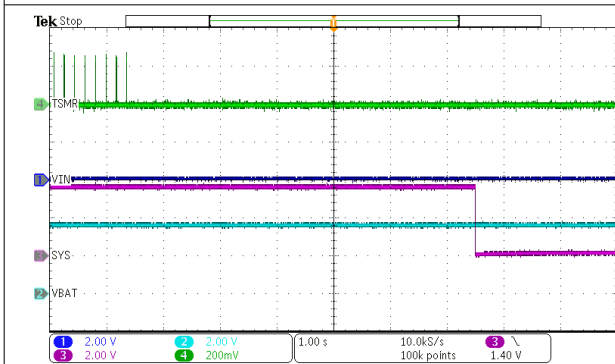

V_{IN} = 0 V
 PB_LPRESS_ACTION = 11 (enable shutown mode)
 MR_LPRESS = 00 (5 seconds)

8-12. Shutdown Mode Entry with Push Button Long Press

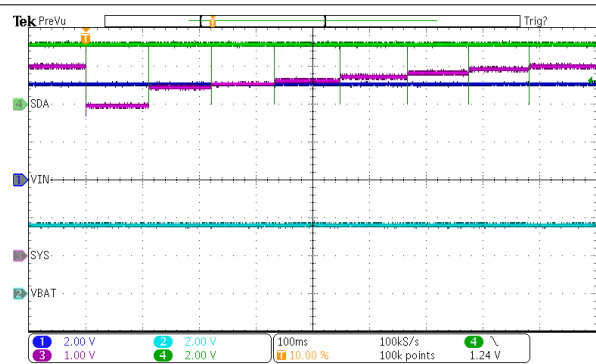

SYS_REG_CTRL = 000 → 111 in steps

8-13. SYS Regulation Sweep

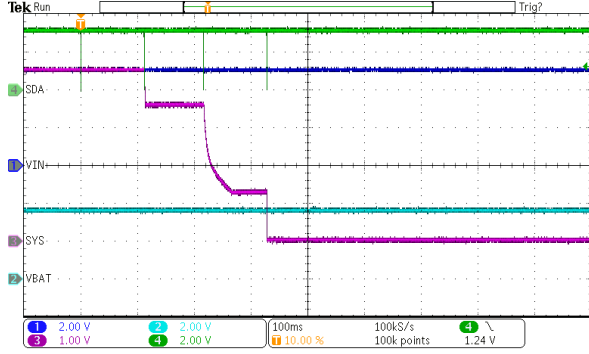

SYS_MODE = 00 → 01 → 10 → 11

8-14. SYS Mode Sweep

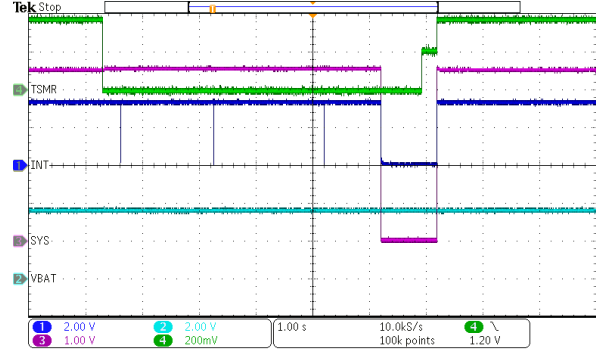

WAKE1 = 300 ms
 WAKE2 = 2 s
 PB_LPRESS_ACTION = HW Reset
 MR_LPRESS = 5 s

8-15. Wake1, Wake2, LP_Warn and Hardware Reset

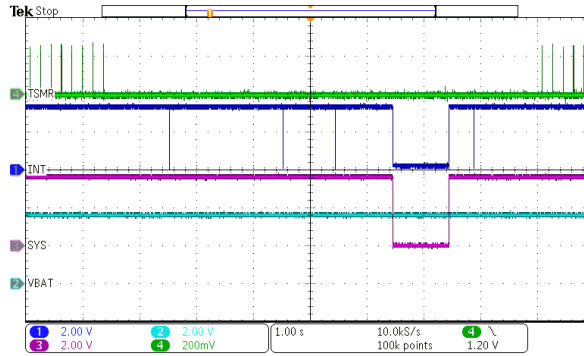

WAKE1 = 1 s
 WAKE2 = 3 s
 PB_LPRESS_ACTION = HW Reset
 MR_LPRESS = 5 s

8-16. Wake2 Interrupt with VIN Present

9 Power Supply Recommendations

The BQ21088 requires the adapter or IN supply to be between 3.3 V and 5.5 V. The battery voltage must be higher than 3.15 V or $V_{BATUVLO}$ to ensure proper operation. Higher input voltages result in higher input dissipation.

10 Layout

10.1 Layout Guidelines

- To obtain optimal performance, the decoupling capacitor from IN to GND, the capacitor from SYS to GND, and the BAT to GND capacitor should be placed as close as possible to the device.
- A solid ground plane should be used that is tied to the GND pin and thermal pad
- The pushbutton GND should be connected as close to the device as possible
- The high current charge paths into IN, SYS, and BAT must be sized appropriately for the maximum charge current in order to avoid voltage drops in these traces

10.2 Layout Example



図 10-1. Board Layout Example

11 Device and Documentation Support

11.1 Device Support

11.1.1 サード・パーティ製品に関する免責事項

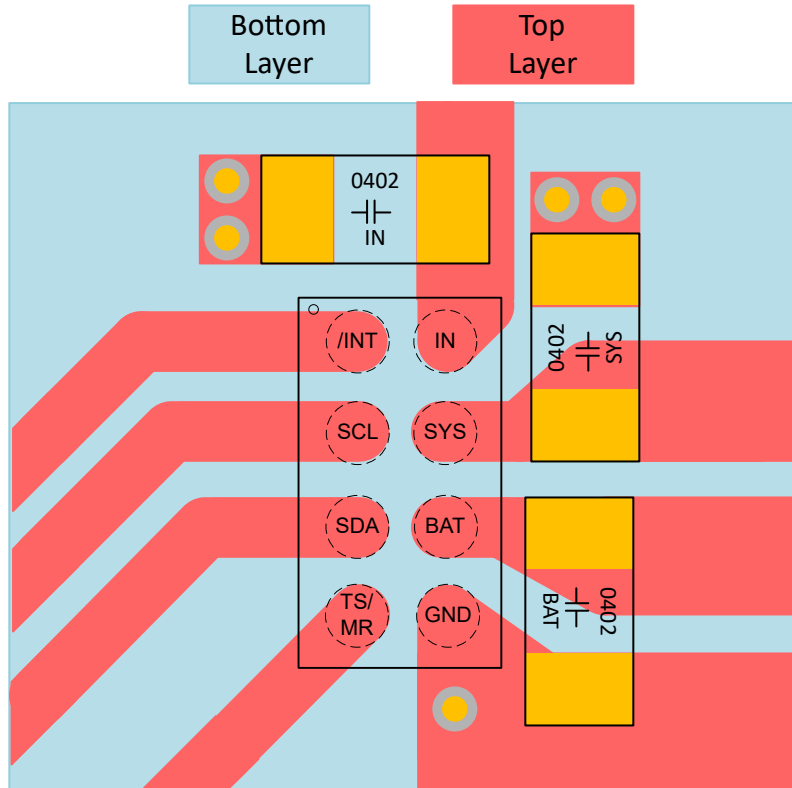
サード・パーティ製品またはサービスに関するテキサス・インスツルメンツの出版物は、単独またはテキサス・インスツルメンツの製品、サービスと一緒に提供される場合に関係なく、サード・パーティ製品またはサービスの適合性に関する是認、サード・パーティ製品またはサービスの是認の表明を意味するものではありません。

11.2 Documentation Support

11.2.1 Related Documentation

11.3 ドキュメントの更新通知を受け取る方法

ドキュメントの更新についての通知を受け取るには、www.tij.co.jp のデバイス製品フォルダを開いてください。[通知] をクリックして登録すると、変更されたすべての製品情報に関するダイジェストを毎週受け取ることができます。変更の詳細については、改訂されたドキュメントに含まれている改訂履歴をご覧ください。

11.4 サポート・リソース

テキサス・インスツルメンツ E2E™ サポート・フォーラムは、エンジニアが検証済みの回答と設計に関するヒントをエキスパートから迅速かつ直接得ることができる場所です。既存の回答を検索したり、独自の質問をしたりすることで、設計に必要な支援を迅速に得ることができます。

リンクされているコンテンツは、各寄稿者により「現状のまま」提供されるものです。これらはテキサス・インスツルメンツの仕様を構成するものではなく、必ずしもテキサス・インスツルメンツの見解を反映したものではありません。テキサス・インスツルメンツの[使用条件](#)を参照してください。

11.5 Trademarks

テキサス・インスツルメンツ E2E™ is a trademark of Texas Instruments.

すべての商標は、それぞれの所有者に帰属します。

11.6 静電気放電に関する注意事項



この IC は、ESD によって破損する可能性があります。テキサス・インスツルメンツは、IC を取り扱う際には常に適切な注意を払うことを推奨します。正しい取り扱いおよび設置手順に従わない場合、デバイスを破損するおそれがあります。

ESD による破損は、わずかな性能低下からデバイスの完全な故障まで多岐にわたります。精密な IC の場合、パラメータがわずかに変化するだけで公表されている仕様から外れる可能性があるため、破損が発生しやすくなっています。

11.7 用語集

[テキサス・インスツルメンツ用語集](#) この用語集には、用語や略語の一覧および定義が記載されています。

12 Revision History

資料番号末尾の英字は改訂を表しています。その改訂履歴は英語版に準じています。

DATE	REVISION	NOTES
November 2024	*	Initial Release

13 Mechanical, Packaging, and Orderable Information

The following pages include mechanical, packaging, and orderable information. This information is the most current data available for the designated devices. This data is subject to change without notice and revision of this document. For browser-based versions of this data sheet, refer to the left-hand navigation.

重要なお知らせと免責事項

テキサス・インスツルメンツは、技術データと信頼性データ (データシートを含みます)、設計リソース (リファレンス デザインを含みます)、アプリケーションや設計に関する各種アドバイス、Web ツール、安全性情報、その他のリソースを、欠陥が存在する可能性のある「現状のまま」提供しており、商品性および特定目的に対する適合性の黙示保証、第三者の知的財産権の非侵害保証を含むいかなる保証も、明示的または黙示的にかかわらず拒否します。

これらのリソースは、テキサス・インスツルメンツ製品を使用する設計の経験を積んだ開発者への提供を意図したものです。(1) お客様のアプリケーションに適した テキサス・インスツルメンツ製品の選定、(2) お客様のアプリケーションの設計、検証、試験、(3) お客様のアプリケーションに該当する各種規格や、その他のあらゆる安全性、セキュリティ、規制、または他の要件への確実な適合に関する責任を、お客様のみが単独で負うものとします。

上記の各種リソースは、予告なく変更される可能性があります。これらのリソースは、リソースで説明されている テキサス・インスツルメンツ製品を使用するアプリケーションの開発の目的でのみ、テキサス・インスツルメンツはその使用をお客様に許諾します。これらのリソースに関して、他の目的で複製することや掲載することは禁止されています。テキサス・インスツルメンツや第三者の知的財産権のライセンスが付与されている訳ではありません。お客様は、これらのリソースを自身で使用した結果発生するあらゆる申し立て、損害、費用、損失、責任について、テキサス・インスツルメンツおよびその代理人を完全に補償するものとし、テキサス・インスツルメンツは一切の責任を拒否します。

テキサス・インスツルメンツの製品は、[テキサス・インスツルメンツの販売条件](#)、または [ti.com](https://www.ti.com) やかかる テキサス・インスツルメンツ製品の関連資料などのいずれかを通じて提供する適用可能な条項の下で提供されています。テキサス・インスツルメンツがこれらのリソースを提供することは、適用されるテキサス・インスツルメンツの保証または他の保証の放棄の拡大や変更を意味するものではありません。

お客様がいかなる追加条項または代替条項を提案した場合でも、テキサス・インスツルメンツはそれらに異議を唱え、拒否します。

郵送先住所: Texas Instruments, Post Office Box 655303, Dallas, Texas 75265

Copyright © 2024, Texas Instruments Incorporated

PACKAGING INFORMATION

Orderable Device	Status (1)	Package Type	Package Drawing	Pins	Package Qty	Eco Plan (2)	Lead finish/ Ball material (6)	MSL Peak Temp (3)	Op Temp (°C)	Device Marking (4/5)	Samples
BQ21088YBGR	ACTIVE	DSBGA	YBG	8	3000	RoHS & Green	SNAGCU	Level-1-260C-UNLIM	-40 to 85	B088	Samples

(1) The marketing status values are defined as follows:

ACTIVE: Product device recommended for new designs.

LIFEBUY: TI has announced that the device will be discontinued, and a lifetime-buy period is in effect.

NRND: Not recommended for new designs. Device is in production to support existing customers, but TI does not recommend using this part in a new design.

PREVIEW: Device has been announced but is not in production. Samples may or may not be available.

OBSELETE: TI has discontinued the production of the device.

(2) **RoHS:** TI defines "RoHS" to mean semiconductor products that are compliant with the current EU RoHS requirements for all 10 RoHS substances, including the requirement that RoHS substance do not exceed 0.1% by weight in homogeneous materials. Where designed to be soldered at high temperatures, "RoHS" products are suitable for use in specified lead-free processes. TI may reference these types of products as "Pb-Free".

RoHS Exempt: TI defines "RoHS Exempt" to mean products that contain lead but are compliant with EU RoHS pursuant to a specific EU RoHS exemption.

Green: TI defines "Green" to mean the content of Chlorine (Cl) and Bromine (Br) based flame retardants meet JS709B low halogen requirements of <=1000ppm threshold. Antimony trioxide based flame retardants must also meet the <=1000ppm threshold requirement.

(3) MSL, Peak Temp. - The Moisture Sensitivity Level rating according to the JEDEC industry standard classifications, and peak solder temperature.

(4) There may be additional marking, which relates to the logo, the lot trace code information, or the environmental category on the device.

(5) Multiple Device Markings will be inside parentheses. Only one Device Marking contained in parentheses and separated by a "~" will appear on a device. If a line is indented then it is a continuation of the previous line and the two combined represent the entire Device Marking for that device.

(6) Lead finish/Ball material - Orderable Devices may have multiple material finish options. Finish options are separated by a vertical ruled line. Lead finish/Ball material values may wrap to two lines if the finish value exceeds the maximum column width.

Important Information and Disclaimer:The information provided on this page represents TI's knowledge and belief as of the date that it is provided. TI bases its knowledge and belief on information provided by third parties, and makes no representation or warranty as to the accuracy of such information. Efforts are underway to better integrate information from third parties. TI has taken and continues to take reasonable steps to provide representative and accurate information but may not have conducted destructive testing or chemical analysis on incoming materials and chemicals. TI and TI suppliers consider certain information to be proprietary, and thus CAS numbers and other limited information may not be available for release.

In no event shall TI's liability arising out of such information exceed the total purchase price of the TI part(s) at issue in this document sold by TI to Customer on an annual basis.

TAPE AND REEL INFORMATION

QUADRANT ASSIGNMENTS FOR PIN 1 ORIENTATION IN TAPE

*All dimensions are nominal

Device	Package Type	Package Drawing	Pins	SPQ	Reel Diameter (mm)	Reel Width W1 (mm)	A0 (mm)	B0 (mm)	K0 (mm)	P1 (mm)	W (mm)	Pin1 Quadrant
BQ21088YBGR	DSBGA	YBG	8	3000	180.0	8.4	1.15	1.75	0.65	4.0	8.0	Q1

TAPE AND REEL BOX DIMENSIONS

*All dimensions are nominal

Device	Package Type	Package Drawing	Pins	SPQ	Length (mm)	Width (mm)	Height (mm)
BQ21088YBGR	DSBGA	YBG	8	3000	182.0	182.0	20.0

YBG0008

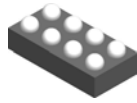

PACKAGE OUTLINE

DSBGA - 0.5 mm max height

DIE SIZE BALL GRID ARRAY

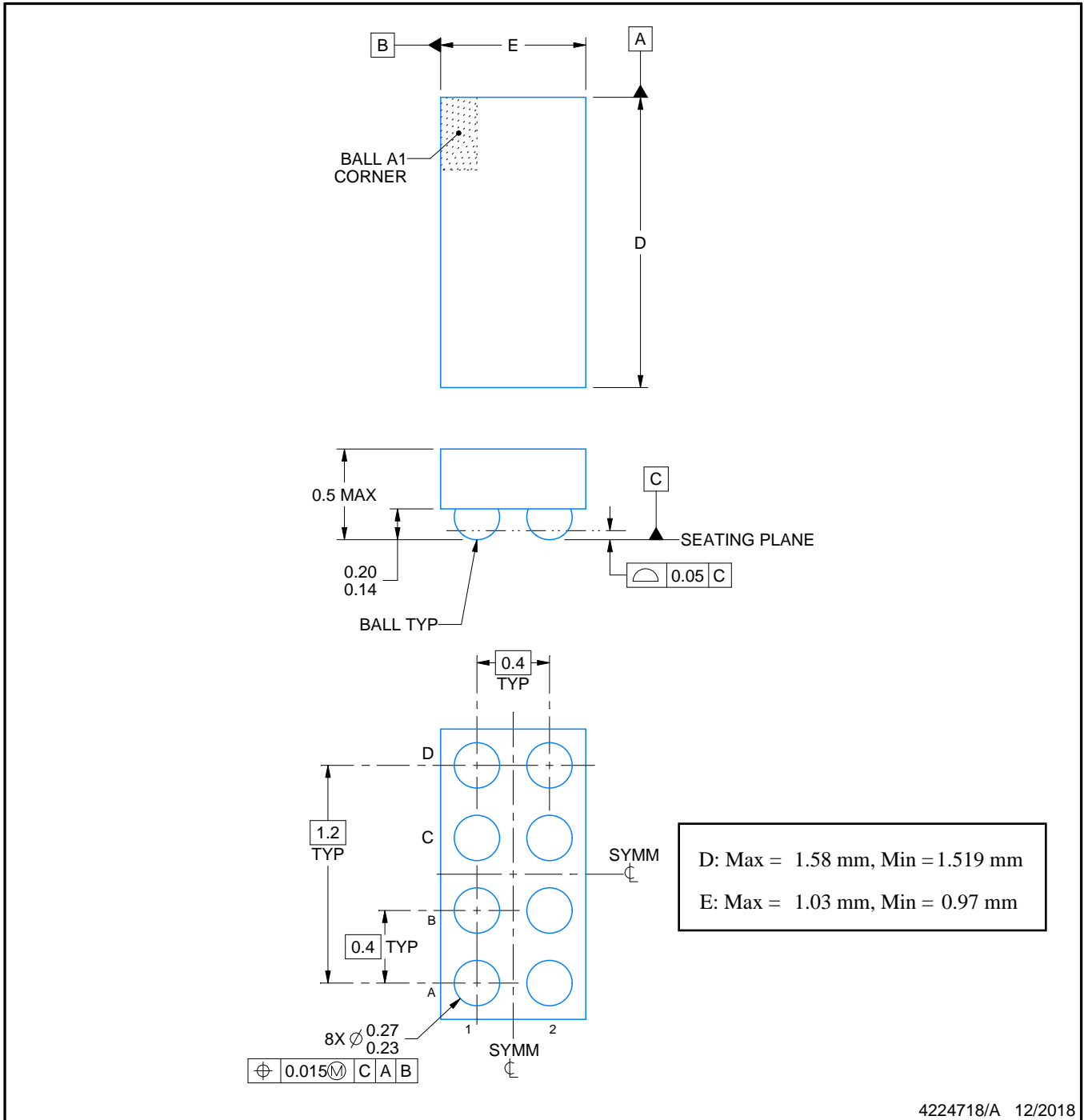

NOTES:

1. All linear dimensions are in millimeters. Any dimensions in parenthesis are for reference only. Dimensioning and tolerancing per ASME Y14.5M.
2. This drawing is subject to change without notice.

EXAMPLE BOARD LAYOUT

YBG0008

DSBGA - 0.5 mm max height

DIE SIZE BALL GRID ARRAY

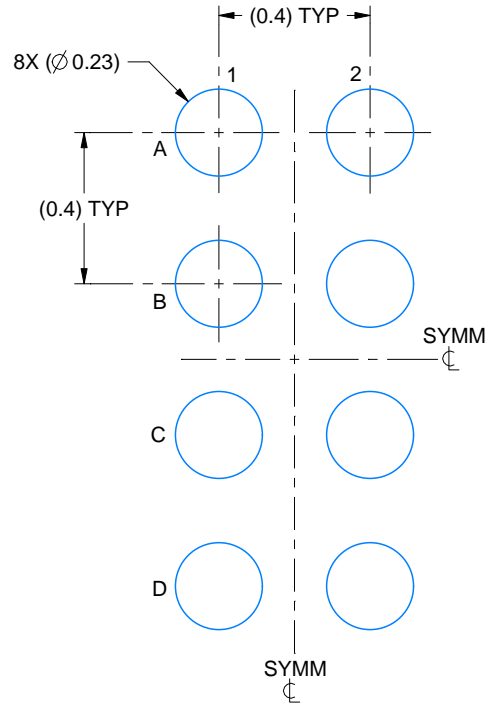

LAND PATTERN EXAMPLE
EXPOSED METAL SHOWN
SCALE: 50X

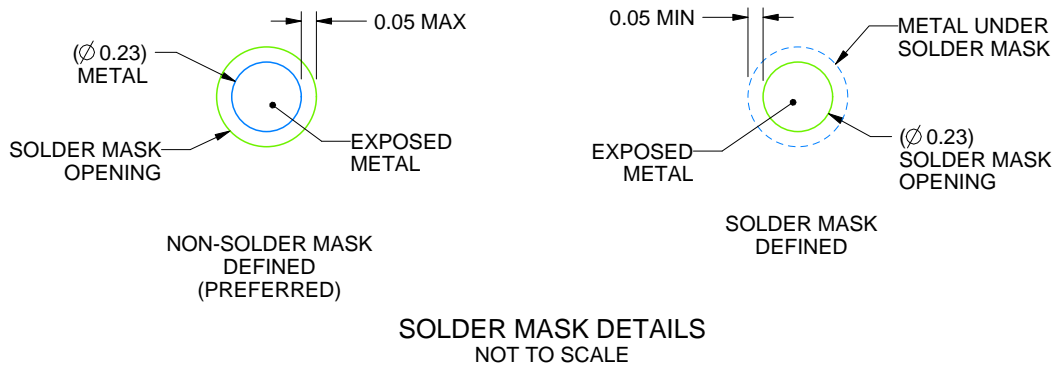

4224718/A 12/2018

NOTES: (continued)

- Final dimensions may vary due to manufacturing tolerance considerations and also routing constraints. See Texas Instruments Literature No. SNVA009 (www.ti.com/lit/snva009).

EXAMPLE STENCIL DESIGN

YBG0008

DSBGA - 0.5 mm max height

DIE SIZE BALL GRID ARRAY

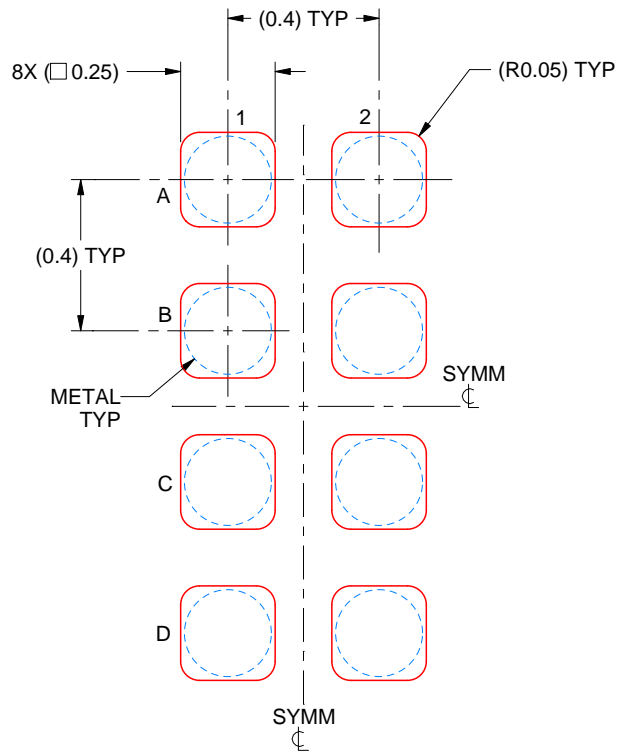

SOLDER PASTE EXAMPLE
BASED ON 0.1 mm THICK STENCIL
SCALE: 50X

4224718/A 12/2018

NOTES: (continued)

4. Laser cutting apertures with trapezoidal walls and rounded corners may offer better paste release.

重要なお知らせと免責事項

TI は、技術データと信頼性データ (データシートを含みます)、設計リソース (リファレンス・デザインを含みます)、アプリケーションや設計に関する各種アドバイス、Web ツール、安全性情報、その他のリソースを、欠陥が存在する可能性のある「現状のまま」提供しており、商品性および特定目的に対する適合性の黙示保証、第三者の知的財産権の非侵害保証を含むいかなる保証も、明示的または黙示的にかかわらず拒否します。

これらのリソースは、TI 製品を使用する設計の経験を積んだ開発者への提供を意図したものです。(1) お客様のアプリケーションに適した TI 製品の選定、(2) お客様のアプリケーションの設計、検証、試験、(3) お客様のアプリケーションに該当する各種規格や、その他のあらゆる安全性、セキュリティ、規制、または他の要件への確実な適合に関する責任を、お客様のみが単独で負うものとし、

上記の各種リソースは、予告なく変更される可能性があります。これらのリソースは、リソースで説明されている TI 製品を使用するアプリケーションの開発の目的でのみ、TI はその使用をお客様に許諾します。これらのリソースに関して、他の目的で複製することや掲載することは禁止されています。TI や第三者の知的財産権のライセンスが付与されている訳ではありません。お客様は、これらのリソースを自身で使用した結果発生するあらゆる申し立て、損害、費用、損失、責任について、TI およびその代理人を完全に補償するものとし、TI は一切の責任を拒否します。

TI の製品は、[TI の販売条件](#)、または [ti.com](#) やかかる TI 製品の関連資料などのいずれかを通じて提供する適用可能な条項の下で提供されています。TI がこれらのリソースを提供することは、適用される TI の保証または他の保証の放棄の拡大や変更を意味するものではありません。

お客様がいかなる追加条項または代替条項を提案した場合でも、TI はそれらに異議を唱え、拒否します。

郵送先住所 : Texas Instruments, Post Office Box 655303, Dallas, Texas 75265
Copyright © 2024, Texas Instruments Incorporated