

12GSPS DAC / 3GSPS ADC 搭載、AFE7950-x 4T6R RF サンプリング AFE

1 特長

- データシート全体のご請求
- 放射線耐性保証 AFE7950-SP:
 - シングル イベント ラッチアップ (SEL): 70MeV-cm²/mg
 - RLAT 吸収線量 (TID): 100krad (Si)
- 耐放射線特性 AFE7950-SEP:
 - シングル イベント ラッチアップ (SEL): 43MeV-cm²/mg
 - RLAT 吸収線量 (TID): 30krad (Si)
- 4 個の RF サンプリング 12GSPS TX DAC
- 6 個の RF サンプリング 3GSPS RX ADC
- 最大 RF 信号帯域幅: 1200MHz (または 2TX の場合は 2400MHz)
- RF 周波数範囲:
 - TX: 600MHz~12GHz
 - RX: 5MHz~12GHz
- デジタル ステップ アッテネータ (DSA):
 - TX: 40dB レンジ、0.125dB ステップ
 - RX または FB: 25dB レンジ、0.5dB ステップ
- TX と RX 向けにシングルバンドまたはデュアルバンド DUC または DDC を搭載
- SerDes データ インターフェイス:
 - 8 個の SerDes トランシーバ (最大 24.75Gbps)
 - JESD204B/C サブクラス 1 互換
- パッケージ: 17mm × 17mm FCBGA、0.8mm ピッチ
- スクリーニング:
 - 単一の製造、アセンブリ、テスト施設
 - 製品のトレーサビリティ
 - 長期にわたる製品ライフ サイクル
 - 長期にわたる製品変更通知
 - ベンダー品目の図面
 - 放射線ロット受け入れ試験 (RLAT) (AFE7950-Sx のみ)
 - ASTM E595 OUT ガス仕様に適合 (AFE7950-Sx のみ)
 - 量産時のバーンイン (AFE7950-SP のみ)

2 アプリケーション

- 衛星通信ペイロードのダウンリンク
- 衛星テレメトリ ペイロードのダウンリンク

3 概要

AFE7950-x は、高性能で広帯域幅のマルチチャネル トランシーバで、4 個の RF サンプリング トランスミッタ チェーン、4 個の RF サンプリング レシーバ チェーン、2 個の RF サンプリング フィードバック チェーン (合計 6 個の RF サンプリング ADC) を統合しています。このデバイスは、最大 12GHz で動作するため、追加の周波数変換段を必要とせず、L、S、C、X バンドの周波数範囲について直接 RF サンプリングが可能です。この密度と柔軟性の向上により、多くのチャネル数を持つマルチミッション システムが可能になります。

TX 信号パスは、4 個の TX で最大 1200MHz の信号帯域幅、または 2 個の TX で 2400MHz を実現する、補間およびデジタル アップコンバージョン オプションをサポートしています。DUC の出力は、2 次ナイキスト動作を拡張する混在モード出力方式で 12GSPS の DAC (D/A コンバータ) を駆動します。DAC 出力は、40dB レンジ、1dB アナログ ステップ、0.125dB デジタル ステップの可変ゲイン アンプ (TX DSA) を内蔵しています。

各レシーバ チェーンは、3GSPS の ADC (A/D コンバータ) に接続された 25dB レンジのデジタル ステップ アッテネータ (DSA) を備えています。各レシーバ チェーンは、外部または内部の自律的な AGC (自動ゲイン制御) を補助するためのアナログ ピーク電力検出器とさまざまなデジタル電力検出器、およびデバイスの信頼性を確保するための RF 過負荷検出器を備えています。柔軟なデシメーション オプションによりデータ帯域幅を最適化でき、FB パスなしの 4 個の RX では最高 1200MHz、2 個の FB パス付き (それぞれ 1200MHz の帯域幅) では最高 600MHz が得られます。

製品情報

部品番号	グレード	パッケージ サイズ ⁽¹⁾ ⁽²⁾
AFE7950-SP	放射線耐性保証宇宙 (RHA)	17mm × 17mm プラスチック サブストレート
AFE7950-SEP ⁽³⁾	耐放射線特性の宇宙用エンハンスト製品	FC-BGA
AFE7950-EP ⁽³⁾	エンハンスト製品	400 SnPb ボール 0.8mm ピッチ

- 詳細については、[セクション 7](#) を参照してください。
- パッケージ サイズ (長さ × 幅) は公称値であり、該当する場合はピンも含まれます。
- 製品プレビュー



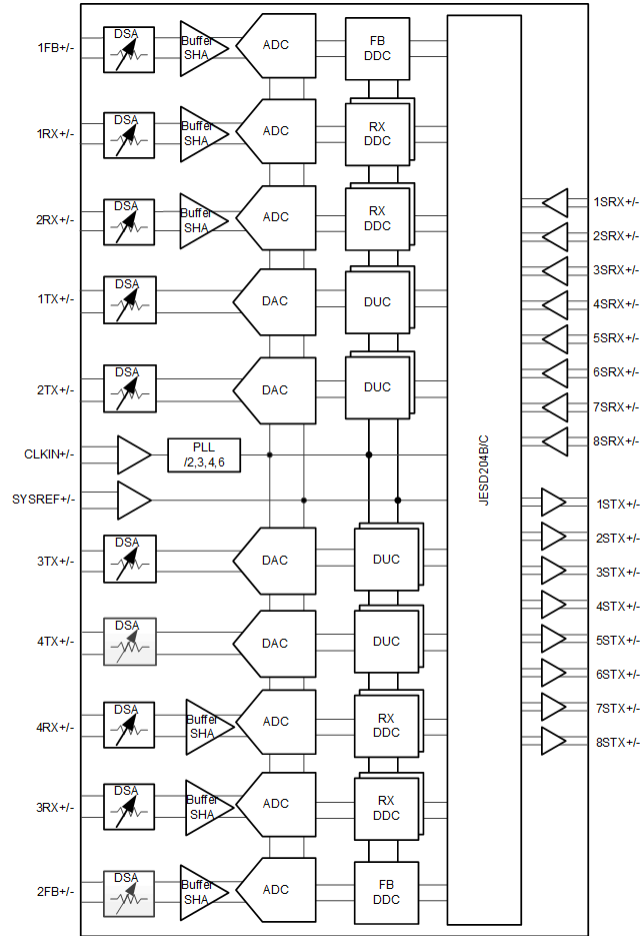

機能ブロック図

Table of Contents

1 特長	1	4.9 Power Supply Electrical Characteristics	21
2 アプリケーション	1	4.10 Timing Requirements	27
3 概要	1	4.11 Switching Characteristics	28
4 Specifications	4	4.12 Typical Characteristics	29
4.1 Absolute Maximum Ratings.....	4	5 Device and Documentation Support	121
4.2 ESD Ratings.....	4	5.1 ドキュメントの更新通知を受け取る方法.....	121
4.3 Recommended Operating Conditions.....	5	5.2 サポート・リソース.....	121
4.4 Thermal Information.....	5	5.3 Trademarks.....	121
4.5 Transmitter Electrical Characteristics.....	6	5.4 静電気放電に関する注意事項.....	121
4.6 RF ADC Electrical Characteristics.....	13	5.5 用語集.....	121
4.7 PLL/VCO/Clock Electrical Characteristics.....	18	6 Revision History	121
4.8 Digital Electrical Characteristics.....	20	7 Mechanical, Packaging, and Orderable Information	121

4 Specifications

4.1 Absolute Maximum Ratings

over operating free-air temperature range (unless otherwise noted)⁽¹⁾

		MIN	MAX	UNIT
Supply Voltage Range	DVDD0P9, VDDT0P9	-0.3	1.2	V
	VDD1P2RX, VDD1P2TXCLK, VDD1P2TXENC, VDD1P2PLL, VDD1P2PLLCLKREF, VDD1P2FB, VDD1P2FBCML, VDD1P2RXCML	-0.3	1.4	V
	VDD1P8RX, VDD1P8RXCLK, VDD1P8TX, VDD1P8TXDAC, VDD1P8TXENC, VDD1P8PLL, VDD1P8PLLVCO, VDD1P8FB, VDD1P8FBCLK, VDD1P8GPIO, VDDA1P8	-0.5	2.1	V
Pin Voltage Range	{1/2/3/4}RXIN+/-	-0.5	VDDR1P8+0.3	V
	1FBIN+/-, 2FB+/-	-0.5	VDDFB1P8+0.3	V
	{1/2/3/4}TXOUT+/-	-0.5	VDDTX1P8+0.3	V
	REFCLK+/-, SYSREF+/-	-0.3	1.4	V
	{1:8}SRX+/-	-0.3	1.4	V
	{1:8}STX+/-	-0.3	1.4	V
	GPIO{B/C/D/E}x, SPICLK, SPISDIO, SPISDO, SPISEN, RESETZ, BISTB0, BISTB1	-0.5	VDD1P8GPIO + 0.3	V
	IFORCE, VSENSE	-0.3	VDDCLK1P8 + 0.3	V
SRDAMUX1, SRDAMUX2	-0.3	VDDA1P8+0.3	V	
Peak Input Current	any input		20	mA
T _J	Junction temperature		150	°C
T _{stg}	Storage temperature	-65	150	°C

(1) Stresses beyond those listed under *Absolute Maximum Rating* may cause permanent damage to the device. These are stress ratings only, which do not imply functional operation of the device at these or any other conditions beyond those indicated under *Recommended Operating Condition*. Exposure to absolute-maximum-rated conditions for extended periods may affect device reliability.

4.2 ESD Ratings

			VALUE	UNIT
V _(ESD)	Electrostatic discharge	Human body model (HBM), per ANSI/ESDA/ JEDEC JS-001, all pins ⁽¹⁾	1000	V
		Charged device model (CDM), per ANSI/ESDA/ JEDEC JS-002, all pins	150	

(1) JEDEC document JEP155 states that 500-V HBM allows safe manufacturing with a standard ESD control process.

4.3 Recommended Operating Conditions

over operating free-air temperature range (unless otherwise noted)

		MIN	NOM	MAX	UNIT
DVDD0P9, VDDT0P9	Supply voltage 0.9V	0.9	0.925	0.95	V
VDD1P2{RX/TXCLK/TXENC/FB/PLL/ PLLCLKREF/FBCML/RXCML}	Supply voltage 1.2V	1.15	1.2	1.25	V
VDD1P8{RX/RXCLK/TX/TXDAC/ TXENC/PLL/PLLVCO/FB/FBCLK/ GPIO}, VDDA1P8	Supply voltage 1.8V	1.75	1.8	1.85	V
T _A	Ambient temperature	-45		85	°C
T _J	Operating Junction Temperature			105	°C

4.4 Thermal Information

THERMAL METRIC ⁽¹⁾		FC-BGA	UNIT
		400 PINS	
R _{θJA}	Junction-to-ambient thermal resistance	15.3	°C/W
R _{θJC(top)}	Junction-to-case (top) thermal resistance	0.44	°C/W
R _{θJB}	Junction-to-board thermal resistance	4.8	°C/W
Ψ _{JB}	Junction-to-board characterization parameter	4.5	°C/W

- (1) For more information about traditional and new thermal metrics, see the [Semiconductor and IC Package Thermal Metrics](#) application report.

4.5 Transmitter Electrical Characteristics

Typical values at $T_A = +25^\circ\text{C}$, full temperature range is $T_{A,\text{MIN}} = -40^\circ\text{C}$ to $T_{J,\text{MAX}} = +110^\circ\text{C}$; TX Input Rate = 491.52MSPS below 6GHz and 1474.56MSPS above 6GHz, $f_{\text{DAC}} = 11796.48\text{MSPS}$; PLL clock mode below 6GHz output frequency and External clock mode above 6GHz output frequency; interleave mode for 1st Nyquist, non-interleave mix mode for 2nd Nyquist, nominal power supplies; 1 tone at -1 dBFS; DSA Attenuation = 0dB; SerDes rate = 16.22Gbps, unless otherwise noted.

PARAMETER		TEST CONDITIONS	MIN	TYP	MAX	UNIT
DAC _{RES}	DAC resolution			14		bits
F _{DAC}	DAC Sample Rate		9		12	GSPS
f _{RFout_MIN}	RF output frequency range	Requires PCB matching based on frequency range		600		MHz
f _{RFout_MAX}	RF output frequency range	Requires PCB matching based on frequency range		12000		MHz
P _{max_FS}	Max Full Scale Output Power, max gain 1 tone, at device pins	f _{out} = 850 MHz, f _{DAC} = 5898.24 MSPS, -0.5dBFS		4.2		dBm
		f _{out} = 1800 MHz, f _{DAC} = 5898.24 MSPS, -0.5dBFS		4.6		dBm
		f _{out} = 2600 MHz, f _{DAC} = 8847.36 MSPS, -0.5dBFS		4.0		dBm
		f _{out} = 3500 MHz, -0.5dBFS		3.9		dBm
		f _{out} = 4900 MHz, -0.5dBFS		3.1		dBm
		f _{out} = 3500 MHz, f _{DAC} = 5898.24 MSPS, -0.5dBFS, straight mode		1.0		dBm
		f _{out} = 4900 MHz, f _{DAC} = 5898.24 MSPS, -0.5dBFS, straight mode		0.1		dBm
		f _{out} = 4900 MHz, f _{DAC} = 8847.36 MSPS, -0.5dBFS, straight mode		-0.7		dBm
		f _{out} = 8100 MHz, -0.1dBFS, mixed mode		-2.8		dBm
f _{out} = 9600 MHz, -0.1dBFS, mixed mode		-4.3		dBm		
R _{TERM}	Output termination resistor	Default setting		50		Ω
ATT _{range}	DSA Attenuation range			40		dB
ATT _{step}	DSA Analog Attenuation step			1.0		dB
	DSA Attenuation step accuracy (DNL)	0 < Atten < 40dB, before calibration		±0.2		dB
	DSA Attenuation step accuracy (DNL)	0 < Atten < 40dB, after calibration		±0.1		dB
ATT _{phase-err}	DSA Gain Steps Phase accuracy, any 8dB range	f _{out} = 850MHz ⁽²⁾		±1		deg
		f _{out} = 1800MHz ⁽²⁾		±1		deg
		f _{out} = 2600MHz ⁽²⁾		±1		deg
		f _{out} = 3500MHz ⁽²⁾		±1		deg
		f _{out} = 4900MHz ⁽²⁾		±1		deg
		f _{out} = 8100MHz ⁽²⁾		±2		deg
G _{flat}	Gain flatness	any 20MHz		0.1		dB
		600MHz BW, F _{out} < 4.9G		1.2		

Typical values at $T_A = +25^\circ\text{C}$, full temperature range is $T_{A,\text{MIN}} = -40^\circ\text{C}$ to $T_{J,\text{MAX}} = +110^\circ\text{C}$; TX Input Rate = 491.52MSPS below 6GHz and 1474.56MSPS above 6GHz, $f_{\text{DAC}} = 11796.48\text{MSPS}$; PLL clock mode below 6GHz output frequency and External clock mode above 6GHz output frequency; interleave mode for 1st Nyquist, non-interleave mix mode for 2nd Nyquist, nominal power supplies; 1 tone at -1 dBFS; DSA Attenuation = 0dB; SerDes rate = 16.22Gbps, unless otherwise noted.

PARAMETER		TEST CONDITIONS	MIN	TYP	MAX	UNIT
IMD3	3rd Order Intermodulation distortion, 2 tones at $f_{\text{IF}} \pm 10\text{ MHz}$	$f_{\text{out}} = 850\text{MHz}$, -7dBFS each tone		-66		dBc
		$f_{\text{out}} = 1800\text{MHz}$, -7dBFS each tone		-63		dBc
		$f_{\text{out}} = 2600\text{MHz}$, -7dBFS each tone		-62		dBc
		$f_{\text{out}} = 3500\text{MHz}$, -7dBFS each tone		-61		dBc
		$f_{\text{out}} = 4900\text{MHz}$, -7dBFS each tone		-57		dBc
		$f_{\text{out}} = 8100\text{MHz}$, -7dBFS each tone		-55		dBc
		$f_{\text{out}} = 9600\text{MHz}$, -7dBFS each tone		-52		dBc
		$f_{\text{out}} = 850\text{MHz}$, -13dBFS each tone		-74		dBc
		$f_{\text{out}} = 1800\text{MHz}$, -13dBFS each tone		-71		dBc
		$f_{\text{out}} = 2501\text{MHz}$, -12dBFS each tone		-67	-60	dBc
		$f_{\text{out}} = 2600\text{MHz}$, -13dBFS each tone		-73		dBc
		$f_{\text{out}} = 3500\text{MHz}$, -13dBFS each tone		-72		dBc
		$f_{\text{out}} = 4900\text{MHz}$, -13dBFS each tone		-68		dBc
		$f_{\text{out}} = 8100\text{MHz}$, -13dBFS each tone		-64		dBc
$f_{\text{out}} = 9600\text{MHz}$, -13dBFS each tone		-68		dBc		
SFDR	Spurious Free Dynamic Range (within Nyquist zone)	$f_{\text{out}} = 850\text{ MHz}$		51		dBc
		$f_{\text{out}} = 1800\text{ MHz}$		52		dBc
		$f_{\text{out}} = 2600\text{ MHz}$		42		dBc
		$f_{\text{out}} = 3500\text{ MHz}$		44		dBc
		$f_{\text{out}} = 4900\text{ MHz}$		46		dBc
$f_{\text{S}}/2 - f_{\text{OUT}}$	Interleaving Image	$f_{\text{DAC}} = 5898.24\text{MSPS}$, interleave mode		-52		dBc
		$f_{\text{DAC}} = 8847.36\text{ MSPS}$, interleave mode		-46		dBc
		$f_{\text{DAC}} = 11796.48\text{MSPS}$, interleave mode		-42		dBc
HD2	2nd Harmonic Distortion (within Nyquist zone)	$f_{\text{out}} = 850\text{ MHz}$		-49		dBc
		$f_{\text{out}} = 1800\text{ MHz}$		-53		dBc
		$f_{\text{out}} = 2600\text{ MHz}$		-50		dBc
		$f_{\text{out}} = 3500\text{ MHz}$		-48		dBc
		$f_{\text{out}} = 4900\text{ MHz}$		-47		dBc
		$f_{\text{out}} = 8100\text{ MHz}$		-50		dBc
		$f_{\text{out}} = 9600\text{ MHz}$		-53		dBc
		$f_{\text{out}} = 850\text{ MHz}$, $A_{\text{OUT}} = -12\text{dBFS}$		-60		dBc
		$f_{\text{out}} = 1800\text{ MHz}$, $A_{\text{OUT}} = -12\text{dBFS}$		-64		dBc
		$f_{\text{out}} = 2600\text{ MHz}$, $A_{\text{OUT}} = -12\text{dBFS}$		-45		dBc
		$f_{\text{out}} = 3500\text{ MHz}$, $A_{\text{OUT}} = -12\text{dBFS}$		-57		dBc
		$f_{\text{out}} = 4900\text{ MHz}$, $A_{\text{OUT}} = -12\text{dBFS}$		-58		dBc
		$f_{\text{out}} = 8100\text{ MHz}$, $A_{\text{OUT}} = -12\text{dBFS}$		-60		dBc
		$f_{\text{out}} = 9600\text{ MHz}$, $A_{\text{OUT}} = -12\text{dBFS}$		-62		dBc

Typical values at $T_A = +25^\circ\text{C}$, full temperature range is $T_{A,\text{MIN}} = -40^\circ\text{C}$ to $T_{J,\text{MAX}} = +110^\circ\text{C}$; TX Input Rate = 491.52MSPS below 6GHz and 1474.56MSPS above 6GHz, $f_{\text{DAC}} = 11796.48\text{MSPS}$; PLL clock mode below 6GHz output frequency and External clock mode above 6GHz output frequency; interleave mode for 1st Nyquist, non-interleave mix mode for 2nd Nyquist, nominal power supplies; 1 tone at -1 dBFS; DSA Attenuation = 0dB; SerDes rate = 16.22Gbps, unless otherwise noted.

PARAMETER		TEST CONDITIONS	MIN	TYP	MAX	UNIT
HD3	3rd Harmonic Distortion (within Nyquist zone)	$f_{\text{out}} = 850 \text{ MHz}$		-62		dBc
		$f_{\text{out}} = 1800 \text{ MHz}$		-55		dBc
		$f_{\text{out}} = 2600 \text{ MHz}$		-57		dBc
		$f_{\text{out}} = 3500 \text{ MHz}$		-60		dBc
		$f_{\text{out}} = 4900 \text{ MHz}$		-54		dBc
		$f_{\text{out}} = 8100 \text{ MHz}$		-54		dBc
		$f_{\text{out}} = 9600 \text{ MHz}$		-56		dBc
		$f_{\text{out}} = 850 \text{ MHz}, A_{\text{OUT}} = -12\text{dBFS}$		-80		dBc
		$f_{\text{out}} = 1800 \text{ MHz}, A_{\text{OUT}} = -12\text{dBFS}$		-79		dBc
		$f_{\text{out}} = 2600 \text{ MHz}, A_{\text{OUT}} = -12\text{dBFS}$		-77		dBc
		$f_{\text{out}} = 3500 \text{ MHz}, A_{\text{OUT}} = -12\text{dBFS}$		-77		dBc
		$f_{\text{out}} = 4900 \text{ MHz}, A_{\text{OUT}} = -12\text{dBFS}$		-78		dBc
		$f_{\text{out}} = 8100 \text{ MHz}, A_{\text{OUT}} = -12\text{dBFS}$		-82		dBc
		$f_{\text{out}} = 9600 \text{ MHz}, A_{\text{OUT}} = -12\text{dBFS}$		-80		dBc
HDn, n >= 4	Harmonic Distortion n >= 4 (within Nyquist zone)	$f_{\text{out}} = 850 \text{ MHz}$		-81		dBc
		$f_{\text{out}} = 1800 \text{ MHz}$		-88		dBc
		$f_{\text{out}} = 2600 \text{ MHz}$		-86		dBc
		$f_{\text{out}} = 3500 \text{ MHz}$		-79		dBc
		$f_{\text{out}} = 4900 \text{ MHz}$		-86		dBc
		$f_{\text{out}} = 8100 \text{ MHz}$		-87		dBc
		$f_{\text{out}} = 9600 \text{ MHz}$		-85		dBc
		$f_{\text{out}} = 850 \text{ MHz}, A_{\text{OUT}} = -12\text{dBFS}$		-93		dBc
		$f_{\text{out}} = 1800 \text{ MHz}, A_{\text{OUT}} = -12\text{dBFS}$		-98		dBc
		$f_{\text{out}} = 2600 \text{ MHz}, A_{\text{OUT}} = -12\text{dBFS}$		-84		dBc
		$f_{\text{out}} = 3500 \text{ MHz}, A_{\text{OUT}} = -12\text{dBFS}$		-87		dBc
		$f_{\text{out}} = 4900 \text{ MHz}, A_{\text{OUT}} = -12\text{dBFS}$		-87		dBc
		$f_{\text{out}} = 8100 \text{ MHz}, A_{\text{OUT}} = -12\text{dBFS}$		-87		dBc
		$f_{\text{out}} = 9600 \text{ MHz}, A_{\text{OUT}} = -12\text{dBFS}$		-87		dBc
SFDR +/- 250 MHz	Spurious Free Dynamic Range within +/- 250 MHz	$f_{\text{out}} = 850 \text{ MHz}$		69		dBc
		$f_{\text{out}} = 1800 \text{ MHz}$		79		dBc
		$f_{\text{out}} = 2600 \text{ MHz}$		77		dBc
		$f_{\text{out}} = 3500 \text{ MHz}$		75		dBc
		$f_{\text{out}} = 4900 \text{ MHz}$		76		dBc
		$f_{\text{out}} = 8100 \text{ MHz}$		61		dBc
$f_s/4$	Fixed Spur	$f_{\text{DAC}} = 5898.24\text{MSPS}$		-64		dBFS
		$f_{\text{DAC}} = 8847.36\text{MSPS}$		-75		dBFS
		$f_{\text{DAC}} = 11796.48\text{MSPS}$		-67		dBFS
$f_s/2$	Fixed Spur	$f_{\text{DAC}} = 5898.24\text{MSPS}$		-49		dBFS
		$f_{\text{DAC}} = 8847.36\text{MSPS}$		-48		dBFS
		$f_{\text{DAC}} = 11796.48 \text{ MSPS}$		-48		dBFS

Typical values at $T_A = +25^\circ\text{C}$, full temperature range is $T_{A,MIN} = -40^\circ\text{C}$ to $T_{J,MAX} = +110^\circ\text{C}$; TX Input Rate = 491.52MSPS below 6GHz and 1474.56MSPS above 6GHz, $f_{DAC} = 11796.48\text{MSPS}$; PLL clock mode below 6GHz output frequency and External clock mode above 6GHz output frequency; interleave mode for 1st Nyquist, non-interleave mix mode for 2nd Nyquist, nominal power supplies; 1 tone at -1 dBFS; DSA Attenuation = 0dB; SerDes rate = 16.22Gbps, unless otherwise noted.

PARAMETER		TEST CONDITIONS	MIN	TYP	MAX	UNIT
3*f _S /4	Fixed Spur	2nd Nyquist, f _{DAC} = 5898.24MSPS		-76		dBFS
		2nd Nyquist, f _{DAC} = 8847.36MSPS		-89		dBFS
		2nd Nyquist, f _{DAC} = 11796.48MSPS		-63		dBFS
ACPR _{1xcarr}	ACPR - 1 carrier, LTE 20MHz E-TM1.1 carrier f _{out} = 0.85 GHz	Atten=0dB, Pout=-13dBFS		-68.5		dBc
		Atten=20dB, Pout=-13dBFS		-67.2		dBc
		Atten=28dB, Pout=-13dBFS		-64.5		dBc
		Atten=39dB, Pout=-13dBFS		-53.9		dBc
ACPR _{1xcarr}	ACPR - 1 carrier, LTE 20MHz E-TM1.1 carrier f _{out} = 1.8425 GHz	Atten=0dB, Pout=-13dBFS		-70.7		dBc
		Atten=20dB, Pout=-13dBFS		-68.3		dBc
		Atten=28dB, Pout=-13dBFS		-62.9		dBc
		Atten=39dB, Pout=-13dBFS		-52.0		dBc
ACPR _{1xcarr}	ACPR - 1 carrier, LTE 20MHz E-TM1.1 carrier f _{out} = 2.6 GHz	Atten=0dB, Pout=-13dBFS		-71		dBc
		Atten=20dB, Pout=-13dBFS		-68		dBc
		Atten=28dB, Pout=-13dBFS		-62		dBc
		Atten=39dB, Pout=-13dBFS		-51.3		dBc
ACPR _{1xcarr}	ACPR - 1 carrier, LTE 20MHz E-TM1.1 carrier f _{out} = 3.5 GHz	Atten=0dB, Pout=-13dBFS		-70		dBc
		Atten=20dB, Pout=-13dBFS		-67		dBc
		Atten=28dB, Pout=-13dBFS		-60		dBc
		Atten=39dB, Pout=-13dBFS		-49.8		dBc
ACPR _{1xcarr}	ACPR - 1 carrier, LTE 20MHz E-TM1.1 carrier f _{out} = 4.9 GHz	Atten=0dB, Pout=-13dBFS		-68.8		dBc
		Atten=20dB, Pout=-13dBFS		-65.9		dBc
		Atten=28dB, Pout=-13dBFS		-60.6		dBc
		Atten=39dB, Pout=-13dBFS		-49.5		dBc
ACPR _{1xcarr}	ACPR - 1 carrier, NR 100MHz E-TM1.1 carrier f _{out} = 2.6 GHz	Atten=0dB, Pout=-13dBFS		-65		dBc
		Atten=20dB, Pout=-13dBFS		-62		dBc
		Atten=20dB, Pout=-13dBFS		-55		dBc
		Atten=39dB, Pout=-13dBFS		-44.3		dBc
ACPR _{1xcarr}	ACPR - 1 carrier, NR 100MHz E-TM1.1 carrier f _{out} = 3.5 GHz	Atten=0dB, Pout=-13dBFS		-64		dBc
		Atten=20dB, Pout=-13dBFS		-59		dBc
		Atten=28dB, Pout=-13dBFS		-52		dBc
		Atten=39dB, Pout=-13dBFS		-41.1		dBc
ACPR _{1xcarr}	ACPR - 1 carrier, NR 100MHz E-TM1.1 carrier f _{out} = 4.9 GHz	Atten=0dB, Pout=-13dBFS		-64.1		dBc
		Atten=20dB, Pout=-13dBFS		-60.4		dBc
		Atten=28dB, Pout=-13dBFS		-53.5		dBc
		Atten=39dB, Pout=-13dBFS		-42.5		dBc
ACPR _{1xcarr}	ACPR - 1 carrier, NR 100MHz E-TM1.1 carrier f _{out} = 8.1 GHz	Atten=0dB, Pout=-13dBFS		-58		dBc
		Atten=20dB, Pout=-13dBFS		-53		dBc
		Atten=28dB, Pout=-13dBFS		-46		dBc
		Atten=39dB, Pout=-13dBFS		-36		dBc
ACPR _{1xcarr}	ACPR - 1 carrier, NR 100MHz E-TM1.1 carrier f _{out} = 9.6 GHz	Atten=0dB, Pout=-13dBFS		-57		dBc
		Atten=20dB, Pout=-13dBFS		-50		dBc
		Atten=28dB, Pout=-13dBFS		-42		dBc
		Atten=39dB, Pout=-13dBFS		-31		dBc

Typical values at $T_A = +25^\circ\text{C}$, full temperature range is $T_{A,\text{MIN}} = -40^\circ\text{C}$ to $T_{J,\text{MAX}} = +110^\circ\text{C}$; TX Input Rate = 491.52MSPS below 6GHz and 1474.56MSPS above 6GHz, $f_{\text{DAC}} = 11796.48\text{MSPS}$; PLL clock mode below 6GHz output frequency and External clock mode above 6GHz output frequency; interleave mode for 1st Nyquist, non-interleave mix mode for 2nd Nyquist, nominal power supplies; 1 tone at -1 dBFS; DSA Attenuation = 0dB; SerDes rate = 16.22Gbps, unless otherwise noted.

PARAMETER		TEST CONDITIONS	MIN	TYP	MAX	UNIT
EVM	Error Vector Magnitude, 1x 20MHz E-TM3.1/3.1a, no ref. clock noise	$F_{\text{out}} = 0.85\text{ GHz}$, $P_{\text{OUT}} = -13\text{dBFS}$		0.16		%
		$F_{\text{out}} = 1.8425\text{ GHz}$, $P_{\text{OUT}} = -13\text{dBFS}$		0.29		%
		$F_{\text{out}} = 2.6\text{ GHz}$, $P_{\text{OUT}} = -13\text{dBFS}$		0.28		%
		$F_{\text{out}} = 3.5\text{ GHz}$, $P_{\text{OUT}} = -13\text{dBFS}$		0.38		%
		$F_{\text{out}} = 4.9\text{ GHz}$, $P_{\text{OUT}} = -13\text{dBFS}$		0.43		%
NSD _{dBFS}	Noise Spectral Density 20MHz offset $f_{\text{OUT}} = 0.85\text{ GHz}$	Atten=0dB, $f_{\text{DAC}} = 5898.24\text{MSPS}$, $P_{\text{out}} = -13\text{dBFS}$		-156		dBFS/ Hz
		Atten=20dB, $f_{\text{DAC}} = 5898.24\text{MSPS}$, $P_{\text{out}} = -13\text{dBFS}$		-151		dBFS/ Hz
		Atten=28dB, $f_{\text{DAC}} = 5898.24\text{MSPS}$, $P_{\text{out}} = -13\text{dBFS}$		-145		dBFS/ Hz
		Atten=39dB, $f_{\text{DAC}} = 5898.24\text{MSPS}$, $P_{\text{out}} = -13\text{dBFS}$		-134		dBFS/ Hz
NSD _{dBFS}	Noise Spectral Density 20MHz offset $f_{\text{OUT}} = 1.8\text{ GHz}$	Atten=0dB, $f_{\text{DAC}} = 5898.24\text{MSPS}$, $P_{\text{out}} = -13\text{dBFS}$		-158		dBFS/ Hz
		Atten=20dB, $f_{\text{DAC}} = 5898.24\text{MSPS}$, $P_{\text{out}} = -13\text{dBFS}$		-152		dBFS/ Hz
		Atten=28dB, $f_{\text{DAC}} = 5898.24\text{MSPS}$, $P_{\text{out}} = -13\text{dBFS}$		-146		dBFS/ Hz
		Atten=39dB, $f_{\text{DAC}} = 5898.24\text{MSPS}$, $P_{\text{out}} = -13\text{dBFS}$		-135		dBFS/ Hz
NSD _{dBFS}	Noise Spectral Density 20MHz offset $f_{\text{OUT}} = 2.6\text{ GHz}$	Atten=0dB, $f_{\text{DAC}} = 8847.36\text{MSPS}$, $P_{\text{out}} = -13\text{dBFS}$		-157		dBFS/ Hz
		Atten=20dB, $f_{\text{DAC}} = 8847.36\text{MSPS}$, $P_{\text{out}} = -13\text{dBFS}$		-151		dBFS/ Hz
		Atten=28dB, $f_{\text{DAC}} = 8847.36\text{MSPS}$, $P_{\text{out}} = -13\text{dBFS}$		-144		dBFS/ Hz
		Atten=39dB, $f_{\text{DAC}} = 8847.36\text{MSPS}$, $P_{\text{out}} = -13\text{dBFS}$		-133		dBFS/ Hz
NSD _{dBFS}	Noise Spectral Density 20MHz offset $F_{\text{out}} = 3.5\text{ GHz}$	Atten=0dB, $P_{\text{out}} = -13\text{dBFS}$		-158		dBFS/ Hz
		Atten=20dB, $P_{\text{out}} = -13\text{dBFS}$		-150		dBFS/ Hz
		Atten=28dB, $P_{\text{out}} = -13\text{dBFS}$		-143		dBFS/ Hz
		Atten=39dB, $P_{\text{out}} = -13\text{dBFS}$		-132		dBFS/ Hz
NSD _{dBFS}	Noise Spectral Density 20MHz offset $F_{\text{out}} = 4.9\text{ GHz}$	Atten=0dB, $P_{\text{out}} = -13\text{dBFS}$		-155		dBFS/ Hz
		Atten=20dB, $P_{\text{out}} = -13\text{dBFS}$		-148		dBFS/ Hz
		Atten=28dB, $P_{\text{out}} = -13\text{dBFS}$		-141		dBFS/ Hz
		Atten=39dB, $P_{\text{out}} = -13\text{dBFS}$		-130		dBFS/ Hz

Typical values at $T_A = +25^\circ\text{C}$, full temperature range is $T_{A,\text{MIN}} = -40^\circ\text{C}$ to $T_{J,\text{MAX}} = +110^\circ\text{C}$; TX Input Rate = 491.52MSPS below 6GHz and 1474.56MSPS above 6GHz, $f_{\text{DAC}} = 11796.48\text{MSPS}$; PLL clock mode below 6GHz output frequency and External clock mode above 6GHz output frequency; interleave mode for 1st Nyquist, non-interleave mix mode for 2nd Nyquist, nominal power supplies; 1 tone at -1 dBFS; DSA Attenuation = 0dB; SerDes rate = 16.22Gbps, unless otherwise noted.

PARAMETER		TEST CONDITIONS	MIN	TYP	MAX	UNIT
NSD _{dBFS}	Noise Spectral Density 50MHz offset $F_{\text{out}} = 8.1\text{ GHz}$	Atten=0dB, Pout=-13dBFS		-149		dBFS/ Hz
		Atten=20dB, Pout=-13dBFS		-147		dBFS/ Hz
		Atten=28dB, Pout=-13dBFS		-141		dBFS/ Hz
		Atten=39dB, Pout=-13dBFS		-130		dBFS/ Hz
NSD _{dBFS}	Noise Spectral Density 50MHz offset $F_{\text{out}} = 9.6\text{ GHz}$	Atten=0dB, Pout=-13dBFS		-148		dBFS/ Hz
		Atten=20dB, Pout=-13dBFS		-144		dBFS/ Hz
		Atten=28dB, Pout=-13dBFS		-137		dBFS/ Hz
		Atten=39dB, Pout=-13dBFS		-126		dBFS/ Hz
S22	Output Return Loss, <6GHz, +/- fc * 10%	with matching		-17		dB
	Output Return Loss, >8GHz, +/- fc * 10%	with matching		-13		dB
Isolation	Near Channel: 1TXOUT to 2TXOUT or 3TXOUT to 4TXOUT ⁽¹⁾	$f_{\text{out}} = 900\text{ MHz}$, $f_{\text{DAC}} = 8847.36\text{MSPS}$, straight mode		-49		dB
		$f_{\text{out}} = 1850\text{ MHz}$, $f_{\text{DAC}} =$ 8847.36MSPS, straight mode		-59		dB
		$f_{\text{out}} = 2600\text{ MHz}$, $f_{\text{DAC}} =$ 8847.36MSPS, straight mode		-64		dB
		$f_{\text{out}} = 3500\text{ MHz}$, $f_{\text{DAC}} =$ 8847.36MSPS, straight mode		-66		dB
		$f_{\text{out}} = 4900\text{ MHz}$, $f_{\text{DAC}} =$ 8847.36MSPS, straight mode		-60		dB
		$f_{\text{out}} = 900\text{ MHz}$, $f_{\text{DAC}} = 8847.36\text{MSPS}$, straight mode		-90		dB
		$f_{\text{out}} = 1850\text{ MHz}$, $f_{\text{DAC}} =$ 8847.36MSPS, straight mode		-91		dB
		$f_{\text{out}} = 2600\text{ MHz}$, $f_{\text{DAC}} =$ 8847.36MSPS, straight mode		-93		dB
		$f_{\text{out}} = 3500\text{ MHz}$, $f_{\text{DAC}} =$ 8847.36MSPS, straight mode		-94		dB
		$f_{\text{out}} = 4900\text{ MHz}$, $f_{\text{DAC}} =$ 8847.36MSPS, straight mode		-83		dB
		$f_{\text{out}} = 8100\text{ MHz}$		-47		dB
		$f_{\text{out}} = 9600\text{ MHz}$		-60		dB
	Far Channel: 1/2TXOUT to 3/4TXOUT	$f_{\text{out}} = 8100\text{ MHz}$		-80		dB

Typical values at $T_A = +25^\circ\text{C}$, full temperature range is $T_{A,\text{MIN}} = -40^\circ\text{C}$ to $T_{J,\text{MAX}} = +110^\circ\text{C}$; TX Input Rate = 491.52MSPS below 6GHz and 1474.56MSPS above 6GHz, $f_{\text{DAC}} = 11796.48\text{MSPS}$; PLL clock mode below 6GHz output frequency and External clock mode above 6GHz output frequency; interleave mode for 1st Nyquist, non-interleave mix mode for 2nd Nyquist, nominal power supplies; 1 tone at -1 dBFS; DSA Attenuation = 0dB; SerDes rate = 16.22Gbps, unless otherwise noted.

PARAMETER		TEST CONDITIONS	MIN	TYP	MAX	UNIT
PN _{TXADD}	Additive Phase Noise External Clock Mode ⁽³⁾	$f_{\text{out}} = 9.6\text{GHz}$, $f_{\text{OFFSET}} = 100\text{Hz}$		-88		dBc/Hz
		$f_{\text{out}} = 9.6\text{GHz}$, $f_{\text{OFFSET}} = 1\text{kHz}$		-102		dBc/Hz
		$f_{\text{out}} = 9.6\text{GHz}$, $f_{\text{OFFSET}} = 10\text{kHz}$		-110		dBc/Hz
		$f_{\text{out}} = 9.6\text{GHz}$, $f_{\text{OFFSET}} = 100\text{kHz}$		-123		dBc/Hz
		$f_{\text{out}} = 9.6\text{GHz}$, $f_{\text{OFFSET}} = 1\text{MHz}$		-136		dBc/Hz
		$f_{\text{out}} = 9.6\text{GHz}$, $f_{\text{OFFSET}} = 10\text{MHz}$		-143		dBc/Hz
		$f_{\text{out}} = 9.6\text{GHz}$, $f_{\text{OFFSET}} = 100\text{MHz}$		-146		dBc/Hz

- (1) Measured with differential 50 ohm across TxP/M. The DC bias to 1.8V to each TxP/M at each pin remains and is not removed. Other external components on the TX paths are disconnected.
- (2) After DSA calibration procedure
- (3) Single side band, input clock phase noise subtracted.

4.6 RF ADC Electrical Characteristics

Typical values at $T_A = +25^\circ\text{C}$, full temperature range is $T_{A,\text{MIN}} = -40^\circ\text{C}$ to $T_{J,\text{MAX}} = +110^\circ\text{C}$; RX Output Rate = 491.52MSPS below 6GHz input frequency and 1474.56MSPS above 6GHz input frequency, $f_{\text{ADC}} = 2949.12\text{MSPS}$; PLL clock mode with $f_{\text{REF}} = 491.52\text{MHz}$ below 6GHz input frequency and External clock mode with $f_{\text{CLK}} = 11796.48\text{MHz}$ above 6GHz input frequency; nominal power supplies; DSA Setting = 4dB below 6GHz and 3dB above 6GHz; SerDes rate =24.33Gbps; unless otherwise noted.

PARAMETER		TEST CONDITIONS	MIN	TYP	MAX	UNIT
ADC _{RES}	ADC resolution			14		bits
F _{ADC}	ADC Sample Rate		1.5		3	GSPS
F _{RFin_MAX}	RF input frequency range	Requires PCB matching based on frequency range		12000		MHz
F _{RFin_MIN}	RF input frequency range	Requires PCB matching based on frequency range		5		MHz
P _{FS_CW,min}	Min Full scale input power, at device pins (1)	f _{IN} = 830 MHz, DSA=0dB		-2.9		dBm
		f _{IN} = 1760 MHz, DSA=0dB		-2.8		dBm
		f _{IN} = 2610 MHz, DSA=0dB		-1.8		dBm
		f _{IN} = 3610 MHz, DSA=0dB		-0.4		dBm
		f _{IN} = 4910 MHz, DSA=0dB		0.1		dBm
		f _{IN} = 8150 MHz, DSA=0dB		2.1		dBm
		f _{IN} = 9610 MHz, DSA=0dB		4.3		dBm
P _{FS_CW,MAX}	MAX Full scale input power - reliability limited, at device pins	f _{IN} = 830 MHz, DSA = 20dB		16.7		dBm
		f _{IN} = 1760 MHz, DSA = 20dB		17.0		dBm
		f _{IN} = 2610 MHz, DSA = 20dB		18		dBm
		f _{IN} = 3610 MHz, DSA = 20dB		18.5		dBm
		f _{IN} = 4910 MHz, DSA = 20dB		19.3		dBm
		f _{IN} = 8150 MHz, DSA = 20dB		21.3		dBm
		f _{IN} = 9610 MHz, DSA = 20dB		23.5		dBm
S11	Input Return Loss	with matching network		-12		dB
ATT _{range}	DSA Attenuation range			25		dB
ATT _{step}	DSA Attenuation step			0.5		dB
	DSA Attenuation step accuracy	Delta=Gatt(X)-Gatt(X-1), F _{in} =3610MHz, after calibration		±0.1		dB
	DSA Gain Steps Phase accuracy any 8dB range	F _{in} =3610MHz, after calibration		±0.9		deg
	DSA Gain Steps Phase accuracy any 8dB range	F _{in} =4910MHz, after calibration		±1.8		deg

Typical values at $T_A = +25^\circ\text{C}$, full temperature range is $T_{A,\text{MIN}} = -40^\circ\text{C}$ to $T_{J,\text{MAX}} = +110^\circ\text{C}$; RX Output Rate = 491.52MSPS below 6GHz input frequency and 1474.56MSPS above 6GHz input frequency, $f_{\text{ADC}} = 2949.12\text{MSPS}$; PLL clock mode with $f_{\text{REF}} = 491.52\text{MHz}$ below 6GHz input frequency and External clock mode with $f_{\text{CLK}} = 11796.48\text{MHz}$ above 6GHz input frequency; nominal power supplies; DSA Setting = 4dB below 6GHz and 3dB above 6GHz; SerDes rate = 24.33Gbps; unless otherwise noted.

PARAMETER		TEST CONDITIONS	MIN	TYP	MAX	UNIT
NSD	Noise Density (small signal)	$f_{\text{IN}} = 830 \text{ MHz}$, DSA = 3dB ⁽³⁾		-155.2		dBFS/Hz
		$f_{\text{IN}} = 1760 \text{ MHz}$, DSA = 3dB ⁽³⁾		-155.0		dBFS/Hz
		$f_{\text{IN}} = 2610 \text{ MHz}$, DSA = 3dB ⁽³⁾		-154.4		dBFS/Hz
		$f_{\text{IN}} = 3610 \text{ MHz}$, DSA = 3dB ⁽³⁾		-154.1		dBFS/Hz
		$f_{\text{IN}} = 4910 \text{ MHz}$, DSA = 3dB ⁽³⁾		-155.1		dBFS/Hz
		$f_{\text{IN}} = 8150 \text{ MHz}$, DSA = 3dB ⁽³⁾		-150		dBFS/Hz
		$f_{\text{IN}} = 9610 \text{ MHz}$, DSA = 3dB ⁽³⁾		-151		dBFS/Hz
		$f_{\text{IN}} = 830 \text{ MHz}$, 3<=Atten<=22		-156.0		dBFS/Hz
		$f_{\text{IN}} = 1760 \text{ MHz}$, 3<=Atten<=25		-155.8		dBFS/Hz
		$f_{\text{IN}} = 2610 \text{ MHz}$, 3<=Atten<=25		-155.7		dBFS/Hz
		$f_{\text{IN}} = 3610 \text{ MHz}$, 3<=Atten<=25		-155.4		dBFS/Hz
		$f_{\text{IN}} = 4910 \text{ MHz}$, 3<=Atten<=25		-155.8		dBFS/Hz
		$f_{\text{IN}} = 8150 \text{ MHz}$, 3<=Atten<=25		-152.5		dBFS/Hz
		$f_{\text{IN}} = 9610 \text{ MHz}$, 3<=Atten<=25		-152.5		dBFS/Hz
NF _{min}	Noise Figure min DSA Atten=0 - 3dB	$f_{\text{IN}} = 830 \text{ MHz}$		19.1		dB
		$f_{\text{IN}} = 1760 \text{ MHz}$		19.0		dB
		$f_{\text{IN}} = 2610 \text{ MHz}$		20.9		dB
		$f_{\text{IN}} = 3610 \text{ MHz}$		22.8		dB
		$f_{\text{IN}} = 4910 \text{ MHz}$		22.4		dB
		$f_{\text{IN}} = 8150 \text{ MHz}$		27.3		dB
		$f_{\text{IN}} = 9610 \text{ MHz}$		30		dB
NF	Noise Figure DSA Atten=4dB	$f_{\text{IN}} = 830 \text{ MHz}$ ⁽⁴⁾		20.0		dB
		$f_{\text{IN}} = 1760 \text{ MHz}$ ⁽⁴⁾		20.6		dB
		$f_{\text{IN}} = 2610 \text{ MHz}$ ⁽⁴⁾		21.9		dB
		$f_{\text{IN}} = 3610 \text{ MHz}$ ⁽⁴⁾		23.5		dB
		$f_{\text{IN}} = 4910 \text{ MHz}$ ⁽⁴⁾		22.3		dB
		$f_{\text{IN}} = 8150 \text{ MHz}$ ⁽⁴⁾		27.9		dB
		$f_{\text{IN}} = 9610 \text{ MHz}$ ⁽⁴⁾		30.7		dB
NF _{max}	Noise Figure DSA Atten=20dB	$f_{\text{IN}} = 830 \text{ MHz}$		34.7		dB
		$f_{\text{IN}} = 1760 \text{ MHz}$		35.2		dB
		$f_{\text{IN}} = 2610 \text{ MHz}$		36.0		dB
		$f_{\text{IN}} = 3610 \text{ MHz}$		37.3		dB
		$f_{\text{IN}} = 4910 \text{ MHz}$		37.6		dB
		$f_{\text{IN}} = 8150 \text{ MHz}$		42.8		dB
		$f_{\text{IN}} = 9610 \text{ MHz}$		45		dB

Typical values at $T_A = +25^\circ\text{C}$, full temperature range is $T_{A,\text{MIN}} = -40^\circ\text{C}$ to $T_{J,\text{MAX}} = +110^\circ\text{C}$; RX Output Rate = 491.52MSPS below 6GHz input frequency and 1474.56MSPS above 6GHz input frequency, $f_{\text{ADC}} = 2949.12\text{MSPS}$; PLL clock mode with $f_{\text{REF}} = 491.52\text{MHz}$ below 6GHz input frequency and External clock mode with $f_{\text{CLK}} = 11796.48\text{MHz}$ above 6GHz input frequency; nominal power supplies; DSA Setting = 4dB below 6GHz and 3dB above 6GHz; SerDes rate = 24.33Gbps; unless otherwise noted.

PARAMETER		TEST CONDITIONS	MIN	TYP	MAX	UNIT
IMD3	3 rd order intermodulation 2 tones at at $f_{\text{IN}} \pm 10\text{MHz}$ -7dBFS each tone	$f_{\text{IN}} = 840\text{ MHz}, 3 \leq \text{Atten} \leq 12$		-82		dBc
		$f_{\text{IN}} = 1770\text{ MHz}, 3 \leq \text{Atten} \leq 12$		-84		dBc
		$f_{\text{IN}} = 2610\text{ MHz}, 3 \leq \text{Atten} \leq 12$		-74		dBc
		$f_{\text{IN}} = 3610\text{ MHz}, 3 \leq \text{Atten} \leq 12$		-77		dBc
		$f_{\text{IN}} = 4920\text{ MHz}, 3 \leq \text{Atten} \leq 12$		-76		dBc
		$f_{\text{IN}} = 8150\text{ MHz}, 3 \leq \text{Atten} \leq 12$, 25MHz tone spacing		-55		dBc
		$f_{\text{IN}} = 9610\text{ MHz}, 3 \leq \text{Atten} \leq 12$, 25MHz tone spacing		-60		dBc
SFDR	Spurious Free Dynamic Range within output bandwidth, $A_{\text{IN}} = -3\text{ dBFS}$	$f_{\text{IN}} = 830\text{ MHz}$		88		dBFS
		$f_{\text{IN}} = 1760\text{ MHz}$		81		dBFS
		$f_{\text{IN}} = 2610\text{ MHz}$		88		dBFS
		$f_{\text{IN}} = 3610\text{ MHz}$		84		dBFS
		$f_{\text{IN}} = 4910\text{ MHz}$		79		dBFS
		$f_{\text{IN}} = 8150\text{ MHz}$		78		dBFS
		$f_{\text{IN}} = 9610\text{ MHz}$		71		dBFS
HD2	2nd Harmonic Distortion $A_{\text{IN}} = -3\text{ dBFS}^{(2)}$	$f_{\text{IN}} = 830\text{ MHz}$		-86		dBFS
		$f_{\text{IN}} = 1760\text{ MHz}$		-91		dBFS
		$f_{\text{IN}} = 2610\text{ MHz}$		-88		dBFS
		$f_{\text{IN}} = 3610\text{ MHz}$		-87		dBFS
		$f_{\text{IN}} = 4910\text{ MHz}$		-84		dBFS
		$f_{\text{IN}} = 8150\text{ MHz}$		-70		dBFS
		$f_{\text{IN}} = 9610\text{ MHz}$		-70		dBFS
HD3	3rd Harmonic Distortion $A_{\text{IN}} = -3\text{ dBFS}$	$f_{\text{IN}} = 830\text{ MHz}$		-80		dBFS
		$f_{\text{IN}} = 1760\text{ MHz}$		-85		dBFS
		$f_{\text{IN}} = 2501\text{ MHz}$		-80	-58	dBFS
		$f_{\text{IN}} = 2610\text{ MHz}$		-85		dBFS
		$f_{\text{IN}} = 3610\text{ MHz}$		-78		dBFS
		$f_{\text{IN}} = 4910\text{ MHz}$		-75		dBFS
		$f_{\text{IN}} = 8150\text{ MHz}$		-70		dBFS
HDn, n>3	SFDR excl. HD2 and HD3 $A_{\text{IN}} = -3\text{ dBFS}$	$f_{\text{IN}} = 830\text{ MHz}$		-88		dBFS
		$f_{\text{IN}} = 1760\text{ MHz}$		-81		dBFS
		$f_{\text{IN}} = 2610\text{ MHz}$		-88		dBFS
		$f_{\text{IN}} = 3610\text{ MHz}$		-84		dBFS
		$f_{\text{IN}} = 4910\text{ MHz}$		-82		dBFS
		$f_{\text{IN}} = 8150\text{ MHz}$		-78		dBFS
		$f_{\text{IN}} = 9610\text{ MHz}$		-78		dBFS

Typical values at $T_A = +25^\circ\text{C}$, full temperature range is $T_{A,\text{MIN}} = -40^\circ\text{C}$ to $T_{J,\text{MAX}} = +110^\circ\text{C}$; RX Output Rate = 491.52MSPS below 6GHz input frequency and 1474.56MSPS above 6GHz input frequency, $f_{\text{ADC}} = 2949.12\text{MSPS}$; PLL clock mode with $f_{\text{REF}} = 491.52\text{MHz}$ below 6GHz input frequency and External clock mode with $f_{\text{CLK}} = 11796.48\text{MHz}$ above 6GHz input frequency; nominal power supplies; DSA Setting = 4dB below 6GHz and 3dB above 6GHz; SerDes rate = 24.33Gbps; unless otherwise noted.

PARAMETER		TEST CONDITIONS	MIN	TYP	MAX	UNIT
SFDR	Spurious Free Dynamic Range $A_{\text{IN}} = -13\text{ dBFS}$ $0 \leq \text{Atten} \leq 16$	$f_{\text{IN}} = 830\text{ MHz}$		89		dBFS
		$f_{\text{IN}} = 1760\text{ MHz}$		89		dBFS
		$f_{\text{IN}} = 2610\text{ MHz}$		95		dBFS
		$f_{\text{IN}} = 3610\text{ MHz}$		90		dBFS
		$f_{\text{IN}} = 4910\text{ MHz}$		90		dBFS
		$f_{\text{IN}} = 8150\text{ MHz}$		83		dBFS
		$f_{\text{IN}} = 9610\text{ MHz}$		80		dBFS
HD2	2nd Harmonic Distortion $A_{\text{IN}} = -13\text{ dBFS}$ $0 \leq \text{Atten} \leq 16$	$f_{\text{IN}} = 830\text{ MHz}$, with board trim		-79		dBFS
		$f_{\text{IN}} = 1760\text{ MHz}$, with board trim		-102		dBFS
		$f_{\text{IN}} = 2610\text{ MHz}$, with board trim		-100		dBFS
		$f_{\text{IN}} = 3610\text{ MHz}$, with board trim		-101		dBFS
		$f_{\text{IN}} = 4910\text{ MHz}$, with board trim		-99		dBFS
		$f_{\text{IN}} = 8150\text{ MHz}$, with board trim		-107		dBFS
		$f_{\text{IN}} = 9610\text{ MHz}$, with board trim		-107		dBFS
HD3	3rd Harmonic Distortion $A_{\text{IN}} = -13\text{ dBFS}$ $0 \leq \text{Atten} \leq 16$	$f_{\text{IN}} = 830\text{ MHz}$		-95		dBFS
		$f_{\text{IN}} = 1760\text{ MHz}$		-95		dBFS
		$f_{\text{IN}} = 2610\text{ MHz}$		-98		dBFS
		$f_{\text{IN}} = 3610\text{ MHz}$		-97		dBFS
		$f_{\text{IN}} = 4910\text{ MHz}$		-94		dBFS
		$f_{\text{IN}} = 8150\text{ MHz}$		-100		dBFS
		$f_{\text{IN}} = 9610\text{ MHz}$		-102		dBFS
HDn, n>3	SFDR excl. HD2 and HD3 $A_{\text{IN}} = -13\text{ dBFS}$ $0 \leq \text{Atten} \leq 16$	$f_{\text{IN}} = 830\text{ MHz}$		-89		dBFS
		$f_{\text{IN}} = 1760\text{ MHz}$		-89		dBFS
		$f_{\text{IN}} = 2610\text{ MHz}$		-95		dBFS
		$f_{\text{IN}} = 3610\text{ MHz}$		-90		dBFS
		$f_{\text{IN}} = 4910\text{ MHz}$		-90		dBFS
		$f_{\text{IN}} = 8150\text{ MHz}$		-83		dBFS
		$f_{\text{IN}} = 9610\text{ MHz}$		-80		dBFS
RX-RX Isolation	Near Channel: 1RXIN to 2RXIN 3RXIN to 4RXIN	$f_{\text{IN}} = 830\text{ MHz}$		-77		dBc
		$f_{\text{IN}} = 1760\text{ MHz}$		-71		dBc
		$f_{\text{IN}} = 2610\text{ MHz}$		-74		dBc
		$f_{\text{IN}} = 3610\text{ MHz}$		-77		dBc
		$f_{\text{IN}} = 4910\text{ MHz}$		-65		dBc
		$f_{\text{IN}} = 8150\text{ MHz}$		-64		dBc
		$f_{\text{IN}} = 9610\text{ MHz}$		-60		dBc
TX-FB Isolation	Near Channel: 2TXOUT to 1FBIN 4TXOUT to 2FBIN	$f_{\text{IN}} = 830\text{ MHz}$		-84		dBc
		$f_{\text{IN}} = 1760\text{ MHz}$		-88		dBc
		$f_{\text{IN}} = 2610\text{ MHz}$		-85		dBc
		$f_{\text{IN}} = 3610\text{ MHz}$		-75		dBc
		$f_{\text{IN}} = 4910\text{ MHz}$		-82		dBc
		$f_{\text{IN}} = 8150\text{ MHz}$		-71		dBc
		$f_{\text{IN}} = 9610\text{ MHz}$		-69		dBc

Typical values at $T_A = +25^\circ\text{C}$, full temperature range is $T_{A,\text{MIN}} = -40^\circ\text{C}$ to $T_{J,\text{MAX}} = +110^\circ\text{C}$; RX Output Rate = 491.52MSPS below 6GHz input frequency and 1474.56MSPS above 6GHz input frequency, $f_{\text{ADC}} = 2949.12\text{MSPS}$; PLL clock mode with $f_{\text{REF}} = 491.52\text{MHz}$ below 6GHz input frequency and External clock mode with $f_{\text{CLK}} = 11796.48\text{MHz}$ above 6GHz input frequency; nominal power supplies; DSA Setting = 4dB below 6GHz and 3dB above 6GHz; SerDes rate =24.33Gbps; unless otherwise noted.

PARAMETER		TEST CONDITIONS	MIN	TYP	MAX	UNIT
TX-RX Isolation	Far Channel: 2TXOUT to 1RXIN 4TXOUT to 3RXIN	$f_{\text{IN}} = 830 \text{ MHz}$		-86		dBc
		$f_{\text{IN}} = 1760 \text{ MHz}$		-87		dBc
		$f_{\text{IN}} = 2610 \text{ MHz}$		-91		dBc
		$f_{\text{IN}} = 3610 \text{ MHz}$		-83		dBc
		$f_{\text{IN}} = 4910 \text{ MHz}$		-82		dBc
		$f_{\text{IN}} = 8150 \text{ MHz}$		-68		dBc
		$f_{\text{IN}} = 9610 \text{ MHz}$		-68		dBc

- (1) The input fullscale at minimum attenuation can be reduce by adding a digital gain range to the DSA, extending the useful range of the DSA. The noise figure remains constant over the digital gain range.
- (2) NLE correction of HD2
- (3) From DSA = 3dB down to 0dB, NSD increases 1dB per DSA dB
- (4) NF increase 1dB per DSA 1dB above DSA = 3dB

4.7 PLL/VCO/Clock Electrical Characteristics

Typical values at TA = +25°C, full temperature range is T_{A,MIN} = -40°C to T_{J,MAX} = +110°C; Reference clock input frequency 491.52MHz (unless otherwise noted), f_{DAC} = f_{VCO}, f_{OUT} = f_{DAC}/4, normalized to f_{VCO}.

PARAMETER		TEST CONDITIONS	MIN	TYP	MAX	UNIT
f _{VCO1}	VCO1 min frequency				7.2	GHz
	VCO1 max frequency		7.68			GHz
f _{VCO2}	VCO2 min frequency				8.8	GHz
	VCO2 max frequency		9.1			GHz
f _{VCO3}	VCO3 min frequency				9.7	GHz
	VCO3 max frequency		10.24			GHz
f _{VCO4}	VCO4 min frequency				11.6	GHz
	VCO4 max frequency		12.08			GHz
DIV _{DAC}	DAC sample rate divider			1, 2 or 3		
DIV _{FBAD} C	ADC sample rate divider from DAC sample rate			1, 2, 3, 4, 6 or 8		
DIV _{RXAD} C	ADC sample rate divider			1, 2, 3, 4, 6 or 8		
PN _{VCO}	Closed Loop Phase Noise F _{PLL} = 11.79848 GHz F _{REF} =491.52MHz	600kHz		-113		dBc/Hz
		800kHz		-116		dBc/Hz
		1MHz		-119		dBc/Hz
		1.8MHz		-125		dBc/Hz
		5MHz		-133		dBc/Hz
		50MHz		-141		dBc/Hz
	Closed Loop Phase Noise F _{PLL} =8.84736 GHz F _{REF} =491.52MHz	600kHz		-114		dBc/Hz
		800kHz		-118		dBc/Hz
		1MHz		-120		dBc/Hz
		1.8MHz		-127		dBc/Hz
		5MHz		-135		dBc/Hz
		50MHz		-142		dBc/Hz
	Closed Loop Phase Noise F _{PLL} = 9.8403 GHz F _{REF} =491.52MHz	600kHz		-113		dBc/Hz
		800kHz		-116		dBc/Hz
		1MHz		-119		dBc/Hz
		1.8MHz		-125		dBc/Hz
		5MHz		-134		dBc/Hz
		50MHz		-140		dBc/Hz
	Closed Loop Phase Noise F _{PLL} = 7.86432GHz F _{REF} =491.52MHz	600kHz		-116		dBc/Hz
		800kHz		-119		dBc/Hz
		1MHz		-122		dBc/Hz
		1.8MHz		-127		dBc/Hz
		5MHz		-136		dBc/Hz
		50MHz		-143		dBc/Hz
F _{rms}	Clock PLL integrated phase error ⁽¹⁾	f _{PLL} =11.79848 GHz, [1KHz, 100MHz]		-43.4		dBc/Hz
		f _{PLL} =8.8536 GHz, [1KHz, 100MHz]		-47.6		dBc/Hz
		f _{PLL} =9.8304 GHz, [1KHz, 100MHz]		-46.2		dBc/Hz
f _{PFD}	PFD frequency		100		500	MHz
F _{REF}	Input clock minimum frequency			0.1		GHz
F _{REF}	Input Clock maximum frequency			12		GHz

Typical values at TA = +25°C, full temperature range is T_{A,MIN} = -40°C to T_{J,MAX} = +110°C; Reference clock input frequency 491.52MHz (unless otherwise noted), f_{DAC} = f_{VCO}, f_{OUT} = f_{DAC}/4, normalized to f_{VCO}.

PARAMETER		TEST CONDITIONS	MIN	TYP	MAX	UNIT
V _{CLKMIN}	Input clock minimum level			0.6		Vppdiff
V _{CLKMAX}	Input Clock maximum level			1.8		Vppdiff
PN _{pll_flat}	Normalized PLL flat Noise	f _{VCO} = 11796.48MHz		-226.5		dBc/Hz
Coupling				AC Coupling Only		
	REFCLK input impedance ⁽²⁾	Parallel resistance		100		Ω
		Parallel capacitance		0.5		pF

(1) Single Sideband, not including the reference clock contribution

(2) Refer to S11 data available from TI for impedance vs frequency

4.8 Digital Electrical Characteristics

Typical values at TA = +25°C, full temperature range is T_{A,MIN} = -40°C to T_{J,MAX} = +110°C (unless otherwise noted)

PARAMETER		TEST CONDITIONS	MIN	TYP	MAX	UNIT
CML SerDes Inputs [8:1]SRX+/-						
V _{SRDIFF}	SerDes Receiver Minimum Input Amplitude			100		mVpp
V _{SRDIFF}	SerDes Receiver Maximum Input Amplitude			1200		mVpp
V _{SRCOM}	SerDes Minimum Input Common Mode			0.5		V
V _{SRCOM}	SerDes Maximum Input Common Mode			0.6		V
Z _{SRdiff}	SerDes Internal Differential Termination ⁽¹⁾			115		Ω
F _{SerDes}	SerDes Bit Rate	Minimum full rate mode		19		Gbps
F _{SerDes}	SerDes Bit Rate	Maximum full rate mode		24.75		Gbps
F _{SerDes}	SerDes Bit Rate	Minimum half rate mode		9.5		Gbps
F _{SerDes}	SerDes Bit Rate	Maximum half rate mode		16.25		Gbps
F _{SerDes}	SerDes Bit Rate	Minimum quarter rate mode		4.75		Gbps
F _{SerDes}	SerDes Bit Rate	Maximum quarter rate mode		8.125		Gbps
	Insertion Loss Tolerance ⁽²⁾	Serdes supply = 1.8V		25		dB
TJ	Total Jitter Tolerance			0.42		UI
CML SerDes Outputs [8:1]STX+/-						
V _{STDIFF}	SerDes Transmitter Minimum Output Amplitude	differential		500		mVpp
V _{STDIFF}	SerDes Transmitter Maximum Output Amplitude	differential		1000		mVpp
V _{STCOM}	SerDes Output Minimum Common Mode			0.5		V
V _{STCOM}	SerDes Output Common Mode			0.6		V
Z _{STdiff}	SerDes Output Impedance			115		Ω
TRF	Output rise and fall time	20-80%		8		ps
TEQS	Equalization range			7		dB
TTJ	Output total jitter			0.21		UI
CMOS I/O: GPIO{B/C/D/E}x, SPICLK, SPIDIO, SPISDO, SPISEN, RESETZ, BISTB0, BISTB1						
V _{IH}	High-Level Input Voltage		0.6×VDD1 P8GPIO			V
V _{IL}	Low-Level Input Voltage			0.4×VDD1 P8GPIO		V
V _{OH}	High-Level Output Voltage		VDD1P8G PIO-0.2			V
V _{OL}	Low-Level Output Voltage				0.2	V
Differential Inputs: SYSREF+/- Mode A						
F _{SYSREFMAX}	SYSREF Input Frequency Maximum			40		MHz
V _{SWINGSRMAX}	SYSREF Input Swing Maximum			1.8		Vppdiff ⁽³⁾
V _{SWINGSRMIN}	SYSREF Input Swing Minimum	f _{REF} < 500MHz		0.3		Vppdiff ⁽³⁾
V _{SWINGSRMIN}	SYSREF Input Swing Minimum	f _{REF} > 500MHz		0.6		Vppdiff ⁽³⁾
V _{COMSRMAX}	SYSREF Input Common Mode Voltage Maximum			0.8		V
V _{COMSRMIN}	SYSREF Input Common Mode Voltage Minimum			0.6		V
Z _T	Input termination	differential		108 ⁽¹⁾		Ω

Typical values at TA = +25°C, full temperature range is TA,MIN = -40°C to TJ,MAX = +110°C (unless otherwise noted)

PARAMETER		TEST CONDITIONS	MIN	TYP	MAX	UNIT
CL	Input capacitance	Each pin to GND		0.5		pF
LVDS Inputs: 0SYNCIN+/- and 1SYNCIN+/-						
VICOM	Input Common Voltage			1.2		V
VID	Differential Input Voltage swing			450		mVppdiff ⁽³⁾
ZT	Input termination	differential		100		Ω
LVDS Outputs: 0SYNCOUT+/- and 1SYNCOUT+/-						
VOCOM	Output Common Voltage			1.2		V
VOD	Differential Output Voltage swing			355		mVppdiff ⁽³⁾

- (1) Default setting. SYSREF termination is programmable between nominally 100Ω, 150Ω and 300Ω
- (2) Loss tolerance is bump to bump from STX to SRX
- (3) Vppdiff is the difference between the maximum differential voltage (positive value) and minimum differential voltage (negative value).

4.9 Power Supply Electrical Characteristics

Typical values at TA = +25°C, full temperature range is TA,MIN = -40°C to TJ,MAX = +110°C; TX Input Rate = 491.52MSPS, fDAC = 8847.36MSPS interleave mode; fADC = 2949.12MSPS; nominal power supplies; 1 tone at -1 dBFS; DSA Attenuation = 0dB; SerDes rate = 24.33Gbps; unless otherwise noted.

PARAMETER		TEST CONDITIONS	MIN	TYP	MAX	UNIT
IVDD1P8	Group 3A: VDD1P8FB + VDD1P8RX + VDD1P8TX	Mode 1: 4T2F - FDD FB 100% on, no RX TX/FB Rate: 491.52 MspS Single Band: 12x Int, FB 6x Dec fDAC = 5898.24 SPS fADC = 2949.12MSPS fTX = 1.85 GHz 64/66 coding, 16.22Gbps TX: 4-8-4-1, FB: 2-4-4-1		948.2		mA
	Group 3B: VDD1P8FBCLK + VDD1P8RXCLK + VDD1P8TXDAC+ VDD1P8GPIO + VDDA1P8			533.7		mA
	Group 3C: VDD1P8PLL + VDD1P8PLLVC0			77.3		mA
IVDD1P2	Group 2A: VDD1P2FB + VDD1P2RX			299.4		mA
	Group 2B: VDD1P2TXCLK + VDD1P2TXENC			804.5		mA
	Group 2C: VDD1P2FBCML + VDD1P2RXCML + VDD1P2PLLCLKREF			49.1		mA
IVDD0P9	Group 1A: DVDD0P9 + VDDT0P9			2041.3		mA
Pdiss	Power Dissipation			6027.1		mW
IVDD1P8	Group 3A: VDD1P8FB + VDD1P8RX + VDD1P8TX		Mode 2: 4T4R - TDD 1F shared with RX TX 75%, RX 25%, FB 75% Dual Band: 12x Int, FB 6x Dec, RX 24x Dec TX/FB Rate 491.52 MspS RX Rate 122.88 MspS fDAC = 8847.36MSPS fADC = 2949.12MSPS fOUT=fIN= 1.9, 2.6 GHz 64/66 coding, 16.22Gbps TX: 8-16-4-1, FB: 2-4-4-1, RX: 2-16-16-1		820.4	
	Group 3B: VDD1P8FBCLK + VDD1P8RXCLK + VDD1P8TXDAC+ VDD1P8GPIO + VDDA1P8			735.2		mA
	Group 3C: VDD1P8PLL + VDD1P8PLLVC0			74.4		mA
IVDD1P2	Group 2A: VDD1P2FB + VDD1P2RX			289.0		mA
	Group 2B: VDD1P2TXCLK + VDD1P2TXENC			822.0		mA
	Group 2C: VDD1P2FBCML + VDD1P2RXCML + VDD1P2PLLCLKREF			45.6		mA
IVDD0P9	Group 1A: DVDD0P9 + VDDT0P9			2263.8		mA
Pdiss	Power Dissipation			6359.2		mW

Typical values at $T_A = +25^\circ\text{C}$, full temperature range is $T_{A,\text{MIN}} = -40^\circ\text{C}$ to $T_{J,\text{MAX}} = +110^\circ\text{C}$; TX Input Rate = 491.52MSPS, $f_{\text{DAC}} = 8847.36\text{MSPS}$ interleave mode; $f_{\text{ADC}} = 2949.12\text{MSPS}$; nominal power supplies; 1 tone at -1 dBFS; DSA Attenuation = 0dB; SerDes rate = 24.33Gbps; unless otherwise noted.

PARAMETER		TEST CONDITIONS	MIN	TYP	MAX	UNIT
I_{VDD1P8}	Group 3A: VDD1P8FB + VDD1P8RX + VDD1P8TX	Mode 3: 4T4R2F - FDD FB 100% on TX Dual Band: 12x Int, FB 6x Dec RX Dual Band: RX 24x TX/FB Rate 491.52 Msps RX Rate 122.88 Msps $f_{\text{DAC}} = 11796.48\text{ MSPS}$ $f_{\text{ADC}} = 2949.12\text{ MSPS}$ $f_{\text{TX}} = 1.85 + 2.15\text{ GHz}$ $f_{\text{RX}} = 1.75 + 1.88\text{ GHz}$ 64/66 coding, 16.22Gbps TX: 8-16-4-1, FB: 2-4-4-1, RX: 2-16-16-1	1668.6			mA
	Group 3B: VDD1P8FBCLK + VDD1P8RXCLK + VDD1P8TXDAC + VDD1P8GPIO + VDDA1P8		965.1			mA
	Group 3C: VDD1P8PLL + VDD1P8PLLVC0		77.6			mA
I_{VDD1P2}	Group 2A: VDD1P2FB + VDD1P2RX		893.4			mA
	Group 2B: VDD1P2TXCLK + VDD1P2TXENC		879.5			mA
	Group 2C: VDD1P2FBCML + VDD1P2RXCML + VDD1P2PLLCLKREF		50.7			mA
I_{VDD0P9}	Group 1A: DVDD0P9 + VDDT0P9		3826.9			mA
P_{diss}	Power Dissipation		10513.0			mW
I_{VDD1P8}	Group 3A: VDD1P8FB + VDD1P8RX + VDD1P8TX		Mode 4: 4T4R2F - FDD FB 100% on 7.5 GSPS DAC, 2.5 GSPS ADC Single Band: 15x Int, FB 5x Dec Dual Band: RX 20x TX/FB Rate 491.52 Msps RX Rate 122.88 Msps $f_{\text{DAC}} = 7372.8\text{ MSPS}$ $f_{\text{ADC}} = 2457.6\text{ MSPS}$ $f_{\text{TX}} = 1.85 + 2.15\text{ GHz}$ $f_{\text{RX}} = 1.75 + 1.88\text{ GHz}$ 64/66 coding, 16.22Gbps TX: 4-8-4-1, FB: 2-4-4-1, RX: 2-16-16-1	1611.5		
	Group 3B: VDD1P8FBCLK + VDD1P8RXCLK + VDD1P8TXDAC + VDD1P8GPIO + VDDA1P8	694.5				mA
	Group 3C: VDD1P8PLL + VDD1P8PLLVC0	72.8				mA
I_{VDD1P2}	Group 2A: VDD1P2FB + VDD1P2RX	768.5				mA
	Group 2B: VDD1P2TXCLK + VDD1P2TXENC	940.5				mA
	Group 2C: VDD1P2FBCML + VDD1P2RXCML + VDD1P2PLLCLKREF	45.5				mA
I_{VDD0P9}	Group 1A: DVDD0P9 + VDDT0P9	3000.5				mA
P_{diss}	Power Dissipation	9087.4				mW
I_{VDD1P8}	Group 3A: VDD1P8FB + VDD1P8RX + VDD1P8TX	Mode 5: 4T4R - TDD 1F shared with RX TX 75%, RX 25%, FB 75% Single Band: 12x Int, FB 3x Dec, RX 6x Dec TX/FB Rate = 983.04 Msps RX Rate 491.52 Msps $f_{\text{DAC}} = 11796.48\text{ MSPS}$ $f_{\text{ADC}} = 2949.12\text{ MSPS}$ $f_{\text{TX}} = 3.5\text{ GHz}$ $f_{\text{RX}} = 3.5\text{ GHz}$ 64/66 coding, 16.22Gbps TX: 8-8-2-1, FB: 4-4-4-2, RX: 4-8-4-1		821.8		
	Group 3B: VDD1P8FBCLK + VDD1P8RXCLK + VDD1P8TXDAC + VDD1P8GPIO + VDDA1P8		808.5			mA
	Group 3C: VDD1P8PLL + VDD1P8PLLVC0		77.4			mA
I_{VDD1P2}	Group 2A: VDD1P2FB + VDD1P2RX		289.5			mA
	Group 2B: VDD1P2TXCLK + VDD1P2TXENC		682.0			mA
	Group 2C: VDD1P2FBCML + VDD1P2RXCML + VDD1P2PLLCLKREF		49.0			mA
I_{VDD0P9}	Group 1A: DVDD0P9 + VDDT0P9		2123.3			mA
P_{diss}	Power Dissipation		6209.3			mW

Typical values at $T_A = +25^\circ\text{C}$, full temperature range is $T_{A,\text{MIN}} = -40^\circ\text{C}$ to $T_{J,\text{MAX}} = +110^\circ\text{C}$; TX Input Rate = 491.52MSPS, $f_{\text{DAC}} = 8847.36\text{MSPS}$ interleave mode; $f_{\text{ADC}} = 2949.12\text{MSPS}$; nominal power supplies; 1 tone at -1 dBFS; DSA Attenuation = 0dB; SerDes rate = 24.33Gbps; unless otherwise noted.

PARAMETER		TEST CONDITIONS	MIN	TYP	MAX	UNIT	
I_{VDD1P8}	Group 3A: VDD1P8FB + VDD1P8RX + VDD1P8TX	Mode 7a: TDD 4T1FB (RX iin Standby) TX 9G and FB 3G -16bit: 368.64M; DSA = 6dB, non-interleave mode RX 3G : 368.64M. 16 bit, Standby Serdes: 25gbps) -> 2 lanes for Rx/FB (lane shared) and 2lanes for Tx	658.1	431.1	75.3	mA	
	Group 3B: VDD1P8FBCLK + VDD1P8RXCLK + VDD1P8TXDAC+ VDD1P8GPIO + VDDA1P8						
	Group 3C: VDD1P8PLL + VDD1P8PLLVC0						
I_{VDD1P2}	Group 2A: VDD1P2FB + VDD1P2RX		189.2	1041.1	39.0	mA	
	Group 2B: VDD1P2TXCLK + VDD1P2TXENC						
	Group 2C: VDD1P2FBCML + VDD1P2RXCML + VDD1P2PLLCLKREF						
I_{VDD0P9}	Group 1A: DVDD0P9 + VDDT0P9		2208.7				mA
P_{diss}	Power Dissipation		5607.0				mW
I_{VDD1P8}	Group 3A: VDD1P8FB + VDD1P8RX + VDD1P8TX		Mode 7b: TDD 4R (TX in Standby) TX 9G and FB 3G -16bit: 368.64M; DSA = 6dB, , non-interleave mode, Standby RX 3G : 368.64M. 16 bit Serdes: 25gbps) -> 2 lanes for Rx/FB (lane shared) and 2lanes for Tx	789.5	471.3	73.4	mA
	Group 3B: VDD1P8FBCLK + VDD1P8RXCLK + VDD1P8TXDAC+ VDD1P8GPIO + VDDA1P8						
	Group 3C: VDD1P8PLL + VDD1P8PLLVC0						
I_{VDD1P2}	Group 2A: VDD1P2FB + VDD1P2RX	599.3		169.6	39.1	mA	
	Group 2B: VDD1P2TXCLK + VDD1P2TXENC						
	Group 2C: VDD1P2FBCML + VDD1P2RXCML + VDD1P2PLLCLKREF						
I_{VDD0P9}	Group 1A: DVDD0P9 + VDDT0P9	1645.3					mA
P_{diss}	Power Dissipation	4851.9					mW
I_{VDD1P8}	Group 3A: VDD1P8FB + VDD1P8RX + VDD1P8TX	Mode 7c: TDD 4T4R1FB TX 9G and FB 3G -16bit: 368.64M; DSA = 6dB, , non-interleave mode, 75% on RX 3G : 368.64M. 16 bit 25% on Serdes: 25gbps) -> 2 lanes for Rx/FB (lane shared) and 2lanes for Tx		691.0	441.2	74.8	mA
I_{VDD1P8}	Group 3B: VDD1P8FBCLK + VDD1P8RXCLK + VDD1P8TXDAC+ VDD1P8GPIO + VDDA1P8						
I_{VDD1P8}	Group 3C: VDD1P8PLL + VDD1P8PLLVC0						
I_{VDD1P2}	Group 2A: VDD1P2FB + VDD1P2RX		291.7				mA
I_{VDD1P2}	Group 2B: VDD1P2TXCLK + VDD1P2TXENC		823.2				mA
I_{VDD1P2}	Group 2C: VDD1P2FBCML + VDD1P2RXCML + VDD1P2PLLCLKREF		39.0				mA
I_{VDD0P9}	Group 1A: DVDD0P9 + VDDT0P9		2067.9				mA
P_{diss}	Power Dissipation		5418.2				mW

Typical values at $T_A = +25^\circ\text{C}$, full temperature range is $T_{A,\text{MIN}} = -40^\circ\text{C}$ to $T_{J,\text{MAX}} = +110^\circ\text{C}$; TX Input Rate = 491.52MSPS, $f_{\text{DAC}} = 8847.36\text{MSPS}$ interleave mode; $f_{\text{ADC}} = 2949.12\text{MSPS}$; nominal power supplies; 1 tone at -1 dBFS; DSA Attenuation = 0dB; SerDes rate = 24.33Gbps; unless otherwise noted.

PARAMETER		TEST CONDITIONS	MIN	TYP	MAX	UNIT
I_{VDD1P8}	Group 3A: VDD1P8FB + VDD1P8RX + VDD1P8TX	Mode 7d: FDD 4T4R1FB TX 9G and FB 3G -16bit: 368.64M; DSA = 6dB, , non-interleave mode, RX 3G : 368.64M. 16 bit Serdes: 25gbps) -> 2 lanes for Rx/FB (lane shared) and 2lanes for Tx		1283.8		mA
I_{VDD1P8}	Group 3B: VDD1P8FBCLK + VDD1P8RXCLK + VDD1P8TXDAC+ VDD1P8GPIO + VDDA1P8			752.0		mA
I_{VDD1P8}	Group 3C: VDD1P8PLL + VDD1P8PLLCO			74.6		mA
I_{VDD1P2}	Group 2A: VDD1P2FB + VDD1P2RX			750.5		mA
I_{VDD1P2}	Group 2B: VDD1P2TXCLK + VDD1P2TXENC			1077.6		mA
I_{VDD1P2}	Group 2C: VDD1P2FBCML + VDD1P2RXCML + VDD1P2PLLCLKREF			47.7		mA
I_{VDD0P9}	Group 1A: DVDD0P9 + VDDT0P9			2695.5		mA
P_{diss}	Power Dissipation		8475.5		mW	
I_{VDD1P8}	Group 3A: VDD1P8FB + VDD1P8RX + VDD1P8TX	Mode 8: same configuration as mode 7, Sleep Mode. SLEEP pin is pull high.		20.3		mA
	Group 3B: VDD1P8FBCLK + VDD1P8RXCLK + VDD1P8TXDAC+ VDD1P8GPIO + VDDA1P8			292.8		mA
	Group 3C: VDD1P8PLL + VDD1P8PLLCO			12.6		mA
I_{VDD1P2}	Group 2A: VDD1P2FB + VDD1P2RX			4.6		mA
	Group 2B: VDD1P2TXCLK + VDD1P2TXENC			54.3		mA
	Group 2C: VDD1P2FBCML + VDD1P2RXCML + VDD1P2PLLCLKREF			15.3		mA
I_{VDD0P9}	Group 1A: DVDD0P9 + VDDT0P9			313.1		mA
P_{diss}	Power Dissipation			956.8		mW
I_{VDD1P8}	Group 3A: VDD1P8FB + VDD1P8RX + VDD1P8TX		Mode 9: 4T4R2F - FDD FB 100% on TX Single Band: 24x Int, FB 12x Dec RX Single Band: RX 24x TX/FB Rate 245.76 Msps RX Rate 122.88 Msps $f_{\text{DAC}} = 5898.24\text{ MSPS}$ $f_{\text{ADC}} = 2949.12\text{ MSPS}$ $f_{\text{TX}} = 0.85\text{ GHz}$ $f_{\text{RX}} = 0.8\text{ GHz}$ 8/10 coding, 9.8304Gbps TX: 4-8-4-1, FB: 2-4-4-1, RX: 2-8-8-1		1593.2	
	Group 3B: VDD1P8FBCLK + VDD1P8RXCLK + VDD1P8TXDAC+ VDD1P8GPIO + VDDA1P8			840.6		mA
	Group 3C: VDD1P8PLL + VDD1P8PLLCO			77.3		mA
I_{VDD1P2}	Group 2A: VDD1P2FB + VDD1P2RX			905.0		mA
	Group 2B: VDD1P2TXCLK + VDD1P2TXENC			817.7		mA
	Group 2C: VDD1P2FBCML + VDD1P2RXCML + VDD1P2PLLCLKREF			52.1		mA
I_{VDD0P9}	Group 1A: DVDD0P9 + VDDT0P9			2405.2		mA
P_{diss}	Power Dissipation			8814.3		mW

Typical values at $T_A = +25^\circ\text{C}$, full temperature range is $T_{A,\text{MIN}} = -40^\circ\text{C}$ to $T_{J,\text{MAX}} = +110^\circ\text{C}$; TX Input Rate = 491.52MSPS, $f_{\text{DAC}} = 8847.36\text{MSPS}$ interleave mode; $f_{\text{ADC}} = 2949.12\text{MSPS}$; nominal power supplies; 1 tone at -1 dBFS; DSA Attenuation = 0dB; SerDes rate = 24.33Gbps; unless otherwise noted.

PARAMETER		TEST CONDITIONS	MIN	TYP	MAX	UNIT
I_{VDD1P8}	Group 3A: VDD1P8FB + VDD1P8RX + VDD1P8TX	Mode 10: 4T4R2F - FDD FB 100% on TX Single Band: 18x Int, FB 6x Dec RX Single Band: RX 12x TX/FB Rate 491.52 Msps RX Rate 245.76 Msps $f_{\text{DAC}} = 8847.36\text{ MSPS}$ $f_{\text{ADC}} = 2949.12\text{ MSPS}$ $f_{\text{TX}} = 1.85\text{ GHz}$ $f_{\text{RX}} = 1.75\text{ GHz}$ 8/10 coding, 9.8304Gbps TX: 8-8-2-1, FB: 4-4-2-1, RX: 4-8-4-1	1626.2			mA
	Group 3B: VDD1P8FBCLK + VDD1P8RXCLK + VDD1P8TXDAC+ VDD1P8GPIO + VDDA1P8		976.4			mA
	Group 3C: VDD1P8PLL + VDD1P8PLLVC0		74.6			mA
I_{VDD1P2}	Group 2A: VDD1P2FB + VDD1P2RX		902.7			mA
	Group 2B: VDD1P2TXCLK + VDD1P2TXENC		1111.9			mA
	Group 2C: VDD1P2FBCML + VDD1P2RXCML + VDD1P2PLLCLKREF		48.0			mA
I_{VDD0P9}	Group 1A: DVDD0P9 + VDDT0P9		3578.9			mA
P_{diss}	Power Dissipation		10515.0			mW
I_{VDD1P8}	Group 3A: VDD1P8FB + VDD1P8RX + VDD1P8TX		Mode 11a: TDD 4T1FB (RX in Standby) Single Band: 8x Int, FB 2x Dec, RX uses FB TX/FB/RX Rate = 1474.56 Msps $f_{\text{DAC}} = 11796.48\text{ MSPS}$ $f_{\text{ADC}} = 2949.12\text{ MSPS}$ $f_{\text{TX}} = f_{\text{RX}} = 8\text{ GHz}$ 64/66 coding, 24.33 Gbps TX: 8-8-2-1, FB/RX: 4-4-4-2	800		
	Group 3B: VDD1P8FBCLK + VDD1P8RXCLK + VDD1P8TXDAC+ VDD1P8GPIO + VDDA1P8	840				mA
	Group 3C: VDD1P8PLL + VDD1P8PLLVC0	73				mA
I_{VDD1P2}	Group 2A: VDD1P2FB + VDD1P2RX	190				mA
	Group 2B: VDD1P2TXCLK + VDD1P2TXENC	1440				mA
	Group 2C: VDD1P2FBCML + VDD1P2RXCML + VDD1P2PLLCLKREF	75				mA
I_{VDD0P9}	Group 1A: DVDD0P9 + VDDT0P9	3070				mA
P_{diss}	Power Dissipation	8010				mW
I_{VDD1P8}	Group 3A: VDD1P8FB + VDD1P8RX + VDD1P8TX	Mode 11b: TDD 4R (TX in Standby) Single Band: 8x Int, FB 2x Dec, RX uses FB TX/FB/RX Rate = 1474.56 Msps $f_{\text{DAC}} = 11796.48\text{ MSPS}$ $f_{\text{ADC}} = 2949.12\text{ MSPS}$ $f_{\text{TX}} = f_{\text{RX}} = 8\text{ GHz}$ 64/66 coding, 24.33 Gbps TX: 8-8-2-1, FB/RX: 4-4-4-2		750		
	Group 3B: VDD1P8FBCLK + VDD1P8RXCLK + VDD1P8TXDAC+ VDD1P8GPIO + VDDA1P8		890			mA
	Group 3C: VDD1P8PLL + VDD1P8PLLVC0		72			mA
I_{VDD1P2}	Group 2A: VDD1P2FB + VDD1P2RX		610			mA
	Group 2B: VDD1P2TXCLK + VDD1P2TXENC		280			mA
	Group 2C: VDD1P2FBCML + VDD1P2RXCML + VDD1P2PLLCLKREF		72			mA
I_{VDD0P9}	Group 1A: DVDD0P9 + VDDT0P9		2360			mA
P_{diss}	Power Dissipation		6460			mW

Typical values at $T_A = +25^\circ\text{C}$, full temperature range is $T_{A,\text{MIN}} = -40^\circ\text{C}$ to $T_{J,\text{MAX}} = +110^\circ\text{C}$; TX Input Rate = 491.52MSPS, $f_{\text{DAC}} = 8847.36\text{MSPS}$ interleave mode; $f_{\text{ADC}} = 2949.12\text{MSPS}$; nominal power supplies; 1 tone at -1 dBFS; DSA Attenuation = 0dB; SerDes rate = 24.33Gbps; unless otherwise noted.

PARAMETER		TEST CONDITIONS	MIN	TYP	MAX	UNIT
I_{VDD1P8}	Group 3A: VDD1P8FB + VDD1P8RX + VDD1P8TX	Mode 11c: TDD 4T4R1FB average TX/FB: 75%, RX 25% Single Band: 8x Int, FB 2x Dec, RX uses FB TX/FB/RX Rate = 1474.56 Msps $f_{\text{DAC}} = 11796.48\text{ MSPS}$ $f_{\text{ADC}} = 2949.12\text{ MSPS}$ $f_{\text{TX}} = f_{\text{RX}} = 8\text{ GHz}$ 64/66 coding, 24.33 Gbps TX: 8-8-2-1, FB/RX: 4-4-4-2		790		mA
	Group 3B: VDD1P8FBCLK + VDD1P8RXCLK + VDD1P8TXDAC + VDD1P8GPIO + VDDA1P8			850		mA
	Group 3C: VDD1P8PLL + VDD1P8PLLVC0			73		mA
I_{VDD1P2}	Group 2A: VDD1P2FB + VDD1P2RX			300		mA
	Group 2B: VDD1P2TXCLK + VDD1P2TXENC			1150		mA
	Group 2C: VDD1P2FBCML + VDD1P2RXCML + VDD1P2PLLCLKREF			75		mA
I_{VDD0P9}	Group 1A: DVDD0P9 + VDDT0P9			2890		mA
P_{diss}	Power Dissipation			7620		mW
I_{VDD1P8}	Group 3A: VDD1P8FB + VDD1P8RX + VDD1P8TX		Mode 11d: FDD 4T4R Single Band: 8x Int, RX uses FB TX/FB/RX Rate = 1474.56 Msps $f_{\text{DAC}} = 11796.48\text{ MSPS}$ $f_{\text{ADC}} = 2949.12\text{ MSPS}$ $f_{\text{TX}} = f_{\text{RX}} = 8\text{ GHz}$ 64/66 coding, 24.33 Gbps TX: 8-8-2-1, FB/RX: 4-4-4-2		1260	
	Group 3B: VDD1P8FBCLK + VDD1P8RXCLK + VDD1P8TXDAC + VDD1P8GPIO + VDDA1P8			940		mA
	Group 3C: VDD1P8PLL + VDD1P8PLLVC0			73		mA
I_{VDD1P2}	Group 2A: VDD1P2FB + VDD1P2RX			630		mA
	Group 2B: VDD1P2TXCLK + VDD1P2TXENC			1480		mA
	Group 2C: VDD1P2FBCML + VDD1P2RXCML + VDD1P2PLLCLKREF			78		mA
I_{VDD0P9}	Group 1A: DVDD0P9 + VDDT0P9			4200		mA
P_{diss}	Power Dissipation			10640		mW

4.10 Timing Requirements

Typical values at $T_A = +25^\circ\text{C}$, full temperature range is $T_{A,\text{MIN}} = -40^\circ\text{C}$ to $T_{J,\text{MAX}} = +110^\circ\text{C}$; TX Input Rate = 491.52MSPS, $f_{\text{DAC}} = 8847.36\text{MSPS}$; $f_{\text{ADC}} = 2949.12\text{MSPS}$; nominal power supplies; 1 tone at -1 dBFS; DSA Attenuation = 0dB; SerDes rate = 24.33Gbps; unless otherwise noted.

		MIN	NOM	MAX	UNIT
Timing: SYSREF+/-					
$t_{\text{s(SYSREF)}}$	Setup Time, SYSREF+/- Valid to Rising Edge of CLK+/-		50		ps
$t_{\text{h(SYSREF)}}$	Hold Time, SYSREF+/- Valid after Rising Edge of CLK+/-		50		ps
Timing: Serial ports					
$t_{\text{s(SENB)}}$	Setup Time, SENB to Rising Edge of SCLK		15		ns
$t_{\text{h(SENB)}}$	Hold Time, SENB after last Rising Edge of SCLK ⁽¹⁾		$5 + t_{\text{SCLK}}$		ns
$t_{\text{s(SDIO)}}$	Setup Time, SDIO valid to Rising Edge of SCLK		15		ns
$t_{\text{h(SDIO)}}$	Hold Time, SDIO valid after Rising Edge of SCLK		5		ns
$t_{\text{(SCLK)_W}}$	Minimum SCLK period: registers write		25		ns
$t_{\text{(SCLK)_R}}$	Minimum SCLK period: registers read		50		ns
$t_{\text{(SCLK)_R}}$	SCLK period: temp sensor ⁽²⁾		1000		ns
$t_{\text{d(data_out)}}$	Minimum Data Output delay after Falling Edge of SCLK		0		ns
	Maximum Data Output delay after Falling Edge of SCLK		15		ns
t_{RESET}	Minimum RESETZ Pulse Width		1		ms

- (1) SDEN\ need to be held one more extra clock cycle with the last SCLK edge
 (2) Temp sensor requires a maximum of 1MHz SCLK cycle.

4.11 Switching Characteristics

Typical values at $T_A = +25^\circ\text{C}$, full temperature range is $T_{A,\text{MIN}} = -40^\circ\text{C}$ to $T_{A,\text{MAX}} = +110^\circ\text{C}$; TX Input Rate = 491.52MSPS, $f_{\text{DAC}} = 8847.36\text{MSPS}$; $f_{\text{ADC}} = 2949.12\text{MSPS}$; nominal power supplies; 1 tone at -1 dBFS; DSA Attenuation = 0dB; SerDes rate = 24.33Gbps; unless otherwise noted.

PARAMETER		TEST CONDITIONS	MIN	TYP	MAX	UNIT
TX Channel Latency						
$t_{\text{JESD TX}}$	JESD to TX output Latency	LMFSHd=2-8-8-1, 368.64 MSPS input rate, 24x Interpolation, Serdes rate = 16.22Gbps (JESD204C)		152		interface clock cycles ⁽¹⁾
		LMFSHd=8-16-4-1, 491.52 MSPS 24x Interpolation, Serdes rate = 16.22Gbps (JESD204C)		176		
		LMFSHd=4-16-8-1, 245.76 MSPS 48x Interpolation, Serdes rate = 16.22Gbps (JESD204C)		124		
		LMFSHd=2-16-16-1, 122.88 MSPS 96x Interpolation, Serdes rate = 16.22Gbps (JESD204C)		97		
RX Channel Latency						
	SerDes Transmitter Analog Delay			3.6		ns
$t_{\text{JESD RX}}$	RX input to JESD output Latency	LMFS=2-16-16-1, 122.88 MSPS, 24x Decimation, Serdes rate = 16.22Gbps (JESD204C)		92		interface clock cycles ⁽¹⁾
		LMFS=4-16-8-1, 245.76 MSPS, 12x Decimation, Serdes rate = 16.22Gbps (JESD204C)		108		
		LMFS=4-8-4-1, 491.52 MSPS, 6x Decimation, Serdes rate = 16.22Gbps (JESD204C)		153		
FB Channel Latency						
	SerDes Transmitter Analog Delay			3.6		ns
$t_{\text{JESD FB}}$	FB input to JESD output Latency	LMFS=1-2-8-1, 368.64 MSPS, 8x Decimation		151		interface clock cycles ⁽¹⁾
		LMFS=2-4-4-1, 491.52 MSPS, 6x Decimation		177		

(1) Interface clock cycles is the period of the digital interface sample rate, e.g. 1GSPS = 1ns.

4.12 Typical Characteristics

4.12.1 TX Typical Characteristics 800MHz

Typical values at $T_A = +25^\circ\text{C}$ with nominal supplies. Default conditions: TX input data rate = 491.52MSPS, $f_{\text{DAC}} = 11796.48\text{MSPS}$ (24x interpolation), interleave mode, 1st Nyquist zone output, PLL clock mode with $f_{\text{REF}} = 491.52\text{MHz}$, $A_{\text{OUT}} = -1\text{dBFS}$, DSA = 0dB, Sin(x)/x enabled, DSA calibrated

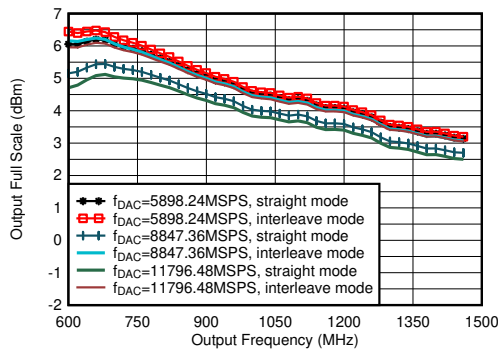

including PCB and cable losses, $A_{\text{out}} = -0.5\text{dBFS}$, DSA = 0, 0.8GHz matching

Figure 4-1. TX Output Fullscale vs Output Frequency

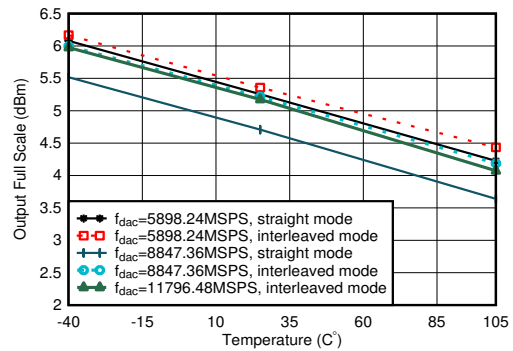

including PCB and cable losses, $A_{\text{out}} = -0.5\text{dBFS}$, DSA = 0, 0.8GHz matching

Figure 4-2. TX Output Fullscale vs Temperature

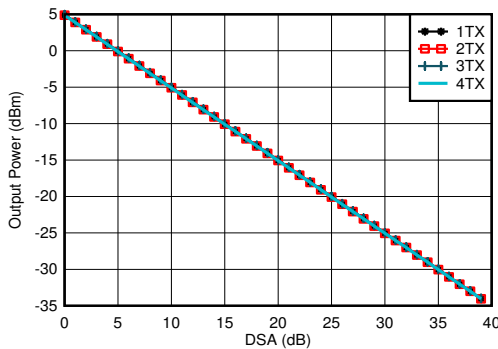

$f_{\text{DAC}} = 11796.48\text{MSPS}$, interleave mode, $A_{\text{out}} = -0.5\text{dBFS}$, matching 0.8GHz

Figure 4-3. TX Output Power vs DSA Setting and Channel at 0.85GHz

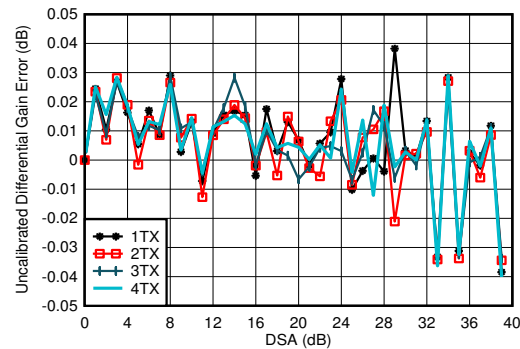

$f_{\text{DAC}} = 5898.24\text{MSPS}$, interleave mode, matching at 0.8GHz
Differential Gain Error = $P_{\text{OUT}}(\text{DSA Setting} - 1) - P_{\text{OUT}}(\text{DSA Setting}) + 1$

Figure 4-4. TX Uncalibrated Differential Gain Error vs DSA Setting and Channel at 0.85GHz

4.12.1 TX Typical Characteristics 800MHz (continued)

Typical values at $T_A = +25^\circ\text{C}$ with nominal supplies. Default conditions: TX input data rate = 491.52MSPS, $f_{\text{DAC}} = 11796.48\text{MSPS}$ (24x interpolation), interleave mode, 1st Nyquist zone output, PLL clock mode with $f_{\text{REF}} = 491.52\text{MHz}$, $A_{\text{OUT}} = -1\text{dBFS}$, DSA = 0dB, Sin(x)/x enabled, DSA calibrated

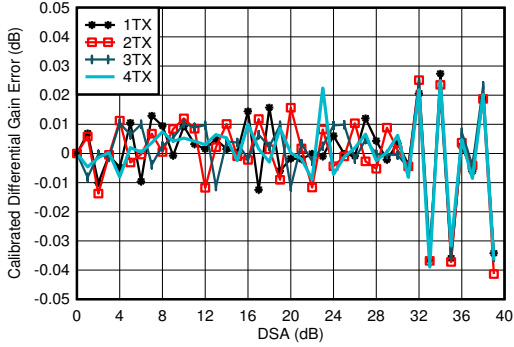

$f_{\text{DAC}} = 5898.24\text{MSPS}$, interleave mode, matching at 0.8GHz
 Differential Gain Error = $P_{\text{OUT}}(\text{DSA Setting} - 1) - P_{\text{OUT}}(\text{DSA Setting}) + 1$

图 4-5. TX Calibrated Differential Gain Error vs DSA Setting and Channel at 0.85GHz

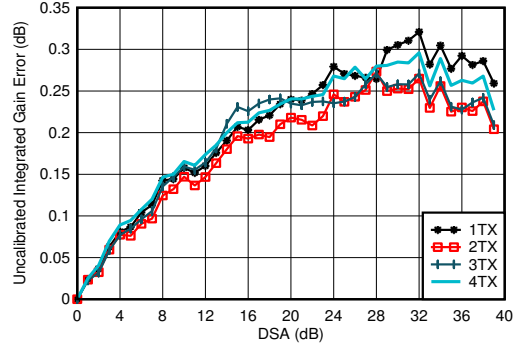

$f_{\text{DAC}} = 5898.24\text{MSPS}$, interleave mode, matching at 0.8GHz
 Integrated Gain Error = $P_{\text{OUT}}(\text{DSA Setting}) - P_{\text{OUT}}(\text{DSA Setting} = 0) + \text{DSA Settings}$

图 4-6. TX Uncalibrated Integrated Gain Error vs DSA Setting and Channel at 0.85GHz

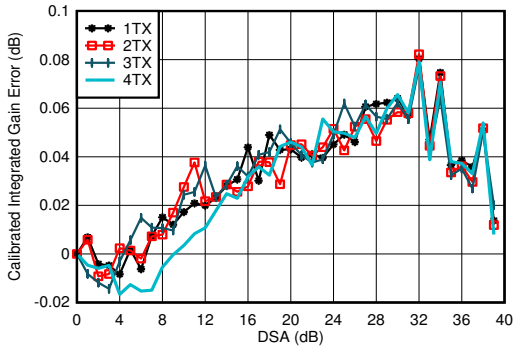

$f_{\text{DAC}} = 5898.24\text{MSPS}$, interleave mode, matching at 0.8GHz
 Integrated Gain Error = $P_{\text{OUT}}(\text{DSA Setting}) - P_{\text{OUT}}(\text{DSA Setting} = 0) + \text{DSA Setting}$

图 4-7. TX Calibrated Integrated Gain Error vs DSA Setting and Channel at 0.85GHz

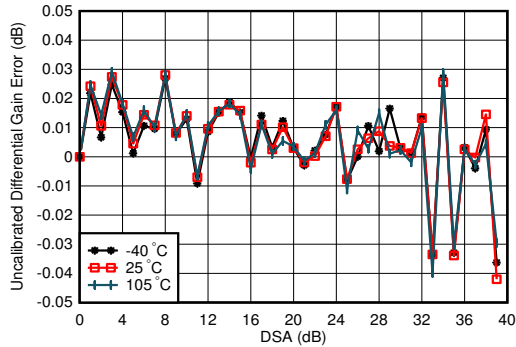

$f_{\text{DAC}} = 5898.24\text{MSPS}$, interleave mode, matching at 0.8GHz
 Differential Gain Error = $P_{\text{OUT}}(\text{DSA Setting} - 1) - P_{\text{OUT}}(\text{DSA Setting}) + 1$

图 4-8. TX Uncalibrated Differential Gain Error vs DSA Setting and Temperature at 0.85GHz

4.12.1 TX Typical Characteristics 800MHz (continued)

Typical values at $T_A = +25^\circ\text{C}$ with nominal supplies. Default conditions: TX input data rate = 491.52MSPS, $f_{\text{DAC}} = 11796.48\text{MSPS}$ (24x interpolation), interleave mode, 1st Nyquist zone output, PLL clock mode with $f_{\text{REF}} = 491.52\text{MHz}$, $A_{\text{OUT}} = -1\text{dBFS}$, DSA = 0dB, Sin(x)/x enabled, DSA calibrated

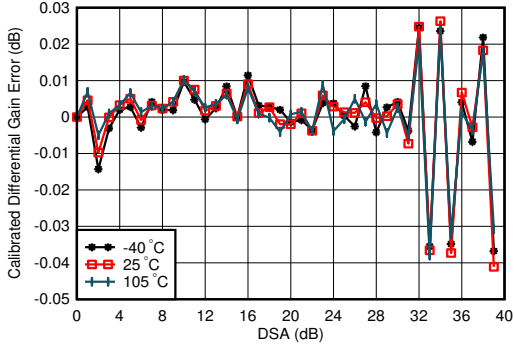

$f_{\text{DAC}} = 5898.24\text{MSPS}$, interleave mode, matching at 0.8GHz
 Differential Gain Error = $P_{\text{OUT}}(\text{DSA Setting} - 1) - P_{\text{OUT}}(\text{DSA Setting}) + 1$

图 4-9. TX Calibrated Differential Gain Error vs DSA Setting and Temperature at 0.85GHz

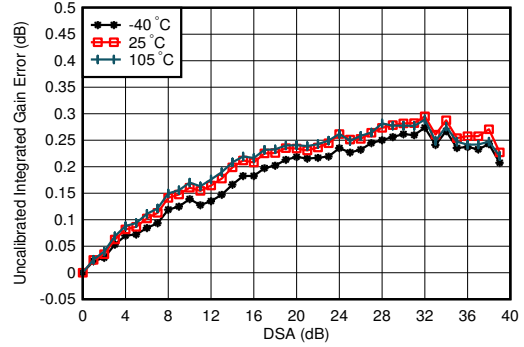

$f_{\text{DAC}} = 5898.24\text{MSPS}$, interleave mode, matching at 0.8GHz
 Integrated Gain Error = $P_{\text{OUT}}(\text{DSA Setting}) - P_{\text{OUT}}(\text{DSA Setting} = 0) + \text{DSA Setting}$

图 4-10. TX Uncalibrated Integrated Gain Error vs DSA Setting and Temperature at 0.85GHz

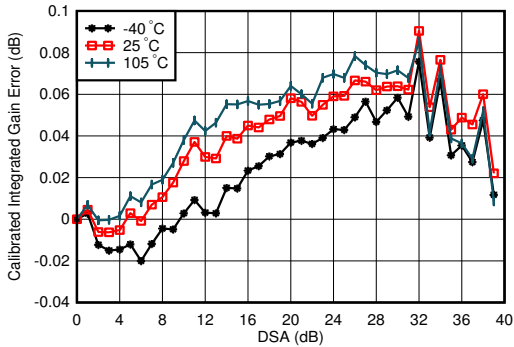

$f_{\text{DAC}} = 5898.24\text{MSPS}$, interleave mode, matching at 0.8GHz
 Integrated Gain Error = $P_{\text{OUT}}(\text{DSA Setting}) - P_{\text{OUT}}(\text{DSA Setting} = 0) + \text{DSA Setting}$

图 4-11. TX Calibrated Integrated Gain Error vs DSA Setting and Temperature at 0.85GHz

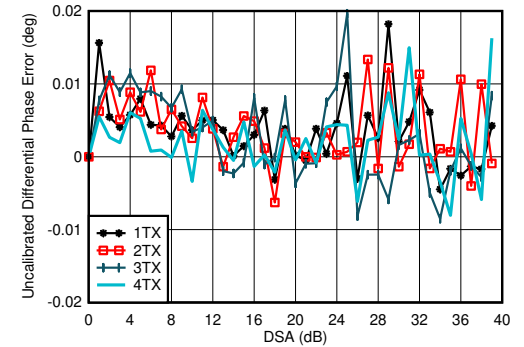

$f_{\text{DAC}} = 5898.24\text{MSPS}$, interleave mode, matching at 0.8GHz
 Differential Phase Error = $\text{Phase}_{\text{OUT}}(\text{DSA Setting} - 1) - \text{Phase}_{\text{OUT}}(\text{DSA Setting})$

图 4-12. TX Uncalibrated Differential Phase Error vs DSA Setting and Channel at 0.85GHz

4.12.1 TX Typical Characteristics 800MHz (continued)

Typical values at $T_A = +25^\circ\text{C}$ with nominal supplies. Default conditions: TX input data rate = 491.52MSPS, $f_{DAC} = 11796.48\text{MSPS}$ (24x interpolation), interleave mode, 1st Nyquist zone output, PLL clock mode with $f_{REF} = 491.52\text{MHz}$, $A_{OUT} = -1\text{dBFS}$, DSA = 0dB, Sin(x)/x enabled, DSA calibrated

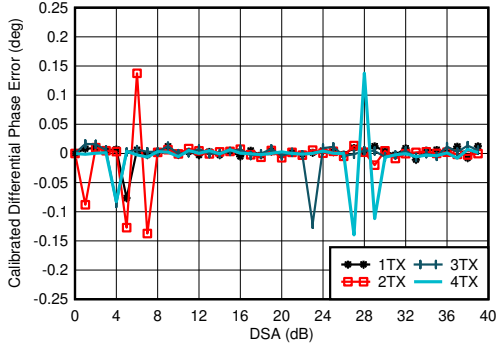

$f_{DAC} = 5898.24\text{MSPS}$, interleave mode, matching at 0.8GHz
 Differential Phase Error = $\text{Phase}_{OUT}(\text{DSA Setting} - 1) - \text{Phase}_{OUT}(\text{DSA Setting})$
 Phase DNL spike may occur at any DSA setting.

图 4-13. TX Calibrated Differential Phase Error vs DSA Setting and Channel at 0.85GHz

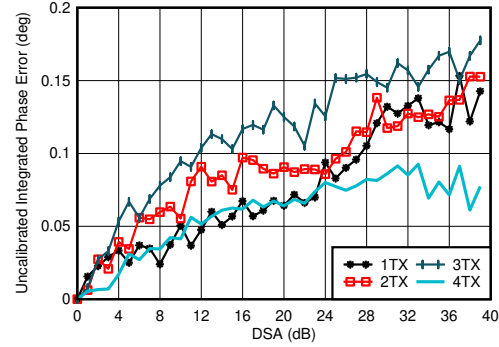

$f_{DAC} = 5898.24\text{MSPS}$, interleave mode, matching at 0.8GHz
 Integrated Phase Error = $\text{Phase}_{OUT}(\text{DSA Setting}) - \text{Phase}_{OUT}(\text{DSA Setting} = 0)$

图 4-14. TX Uncalibrated Integrated Phase Error vs DSA Setting and Channel at 0.85GHz

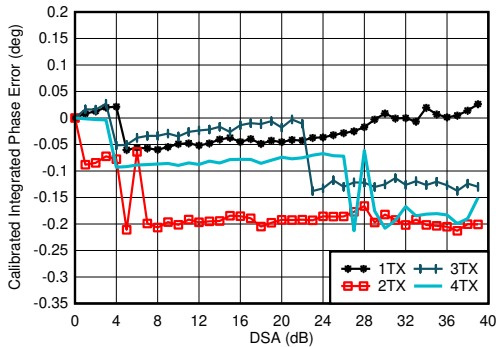

$f_{DAC} = 5898.24\text{MSPS}$, interleave mode, matching at 0.8GHz
 Integrated Phase Error = $\text{Phase}_{OUT}(\text{DSA Setting}) - \text{Phase}_{OUT}(\text{DSA Setting} = 0)$

图 4-15. TX Calibrated Integrated Phase Error vs DSA Setting and Channel at 0.85GHz

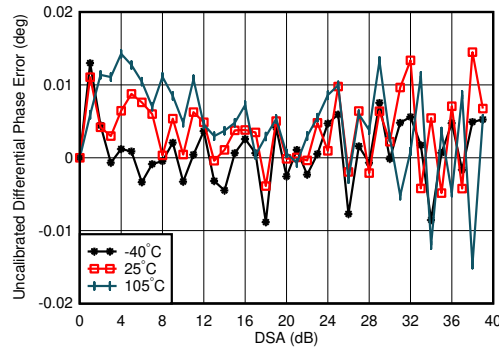

$f_{DAC} = 5898.24\text{MSPS}$, interleave mode, matching at 0.8GHz
 Differential Phase Error = $\text{Phase}_{OUT}(\text{DSA Setting} - 1) - \text{Phase}_{OUT}(\text{DSA Setting}) + 1$

图 4-16. TX Uncalibrated Differential Phase Error vs DSA Setting and Temperature at 0.85GHz

4.12.1 TX Typical Characteristics 800MHz (continued)

Typical values at $T_A = +25^\circ\text{C}$ with nominal supplies. Default conditions: TX input data rate = 491.52MSPS, $f_{\text{DAC}} = 11796.48\text{MSPS}$ (24x interpolation), interleave mode, 1st Nyquist zone output, PLL clock mode with $f_{\text{REF}} = 491.52\text{MHz}$, $A_{\text{OUT}} = -1\text{dBFS}$, DSA = 0dB, Sin(x)/x enabled, DSA calibrated

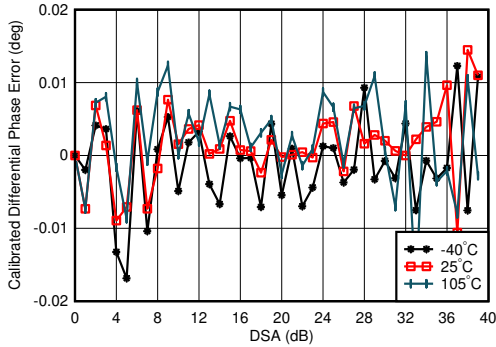

$f_{\text{DAC}} = 5898.24\text{MSPS}$, interleave mode, matching at 0.8GHz, channel with the median variation over DSA setting at 25°C
Differential Phase Error = $\text{Phase}_{\text{OUT}}(\text{DSA Setting} - 1) - \text{Phase}_{\text{OUT}}(\text{DSA Setting}) + 1$

图 4-17. TX Calibrated Differential Phase Error vs DSA Setting and Temperature at 0.85GHz

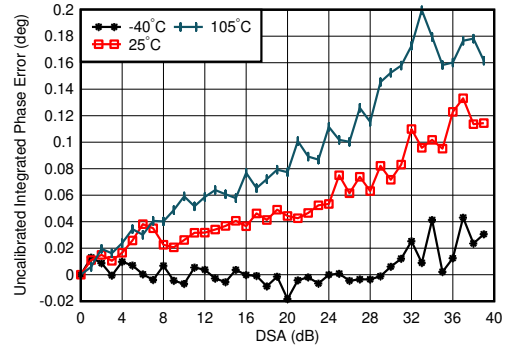

$f_{\text{DAC}} = 5898.24\text{MSPS}$, interleave mode, matching at 0.8GHz
Integrated Phase Error = $\text{Phase}_{\text{OUT}}(\text{DSA Setting}) - \text{Phase}_{\text{OUT}}(\text{DSA Setting} = 0)$

图 4-18. TX Uncalibrated Integrated Phase Error vs DSA Setting and Temperature at 0.85GHz

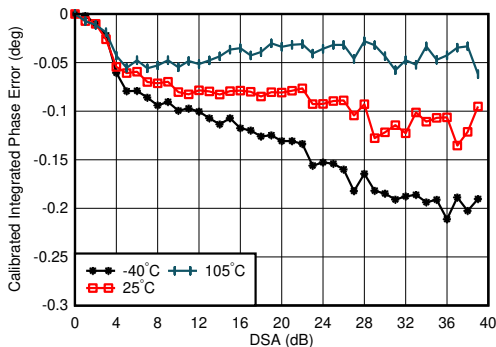

$f_{\text{DAC}} = 5898.24\text{MSPS}$, interleave mode, matching at 0.8GHz
Integrated Phase Error = $\text{Phase}_{\text{OUT}}(\text{DSA Setting}) - \text{Phase}_{\text{OUT}}(\text{DSA Setting} = 0)$

图 4-19. TX Calibrated Integrated Phase Error vs DSA Setting and Temperature at 0.85GHz

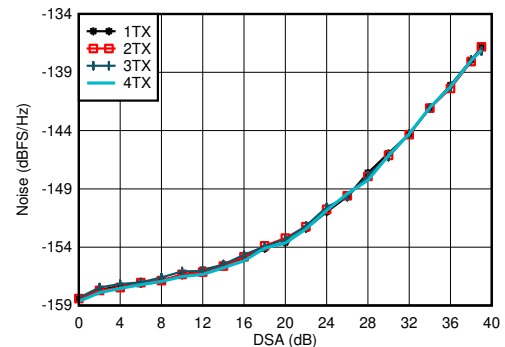

$f_{\text{DAC}} = 5898.24\text{MSPS}$, interleave mode, matching at 0.8GHz, $P_{\text{OUT}} = -13\text{ dBFS}$

图 4-20. TX Output Noise vs Channel and Attenuation at 0.85GHz

4.12.1 TX Typical Characteristics 800MHz (continued)

Typical values at $T_A = +25^\circ\text{C}$ with nominal supplies. Default conditions: TX input data rate = 491.52MSPS, $f_{DAC} = 11796.48\text{MSPS}$ (24x interpolation), interleave mode, 1st Nyquist zone output, PLL clock mode with $f_{REF} = 491.52\text{MHz}$, $A_{OUT} = -1\text{dBFS}$, DSA = 0dB, Sin(x)/x enabled, DSA calibrated

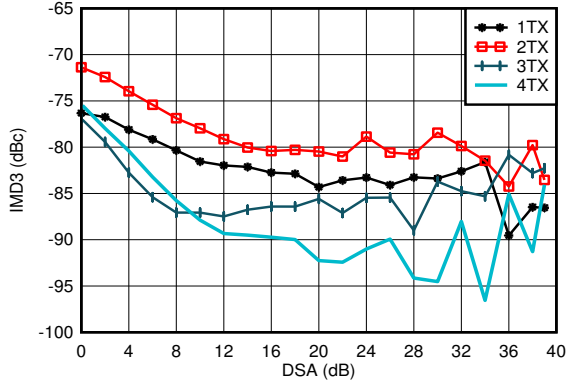

$f_{DAC} = 11796.48\text{MSPS}$, interleave mode, $f_{CENTER} = 0.85\text{GHz}$, matching at 0.8 GHz, -13dBFS each tone

Figure 4-21. TX IMD3 vs DSA Setting at 0.85GHz

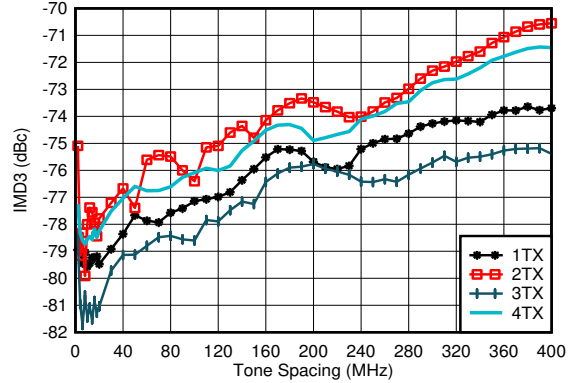

$f_{DAC} = 5898.24\text{MSPS}$, straight mode, $f_{CENTER} = 0.85\text{GHz}$, matching at 0.8GHz, -13dBFS each tone

Figure 4-22. TX IMD3 vs Tone Spacing and Channel at 0.85GHz

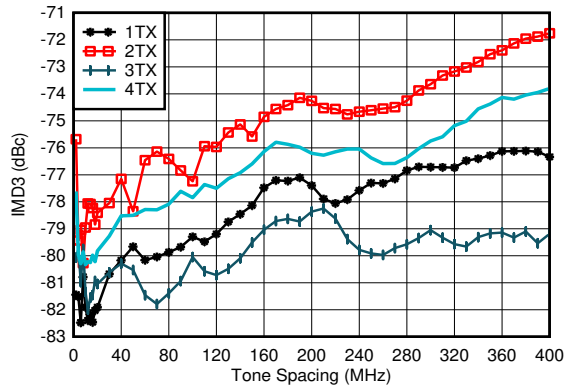

$f_{DAC} = 8847.36\text{MSPS}$, straight mode, $f_{CENTER} = 0.85\text{GHz}$, matching at 0.8GHz, -13dBFS each tone

Figure 4-23. TX IMD3 vs Tone Spacing and Channel at 0.85GHz

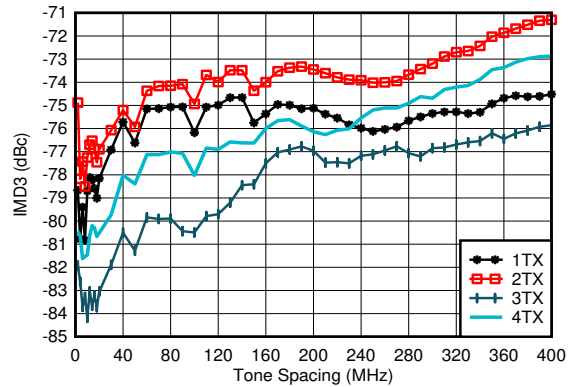

$f_{DAC} = 11796.48\text{MSPS}$, interleave mode, $f_{CENTER} = 0.85\text{GHz}$, matching at 0.8GHz, -13dBFS each tone

Figure 4-24. TX IMD3 vs Tone Spacing and Channel at 0.85GHz

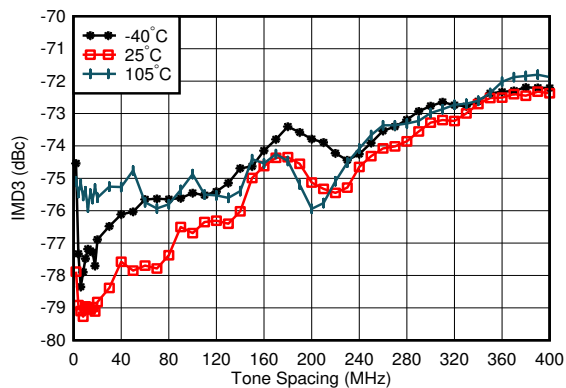

$f_{DAC} = 5898.24\text{MSPS}$, straight mode, $f_{CENTER} = 0.85\text{GHz}$, matching at 0.8GHz, -13dBFS each tone, worst channel

Figure 4-25. TX IMD3 vs Tone Spacing and Temperature at 0.85GHz

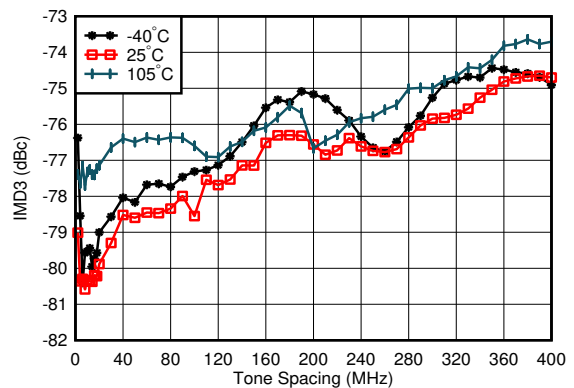

$DAC = 8847.3\text{MSPS}$, straight mode, $f_{CENTER} = 0.85\text{GHz}$, matching at 0.8 GHz, -13dBFS each tone, worst channel

Figure 4-26. TX IMD3 vs Tone Spacing and Temperature at 0.85GHz

4.12.1 TX Typical Characteristics 800MHz (continued)

Typical values at $T_A = +25^\circ\text{C}$ with nominal supplies. Default conditions: TX input data rate = 491.52MSPS, $f_{\text{DAC}} = 11796.48\text{MSPS}$ (24x interpolation), interleave mode, 1st Nyquist zone output, PLL clock mode with $f_{\text{REF}} = 491.52\text{MHz}$, $A_{\text{OUT}} = -1\text{dBFS}$, DSA = 0dB, Sin(x)/x enabled, DSA calibrated

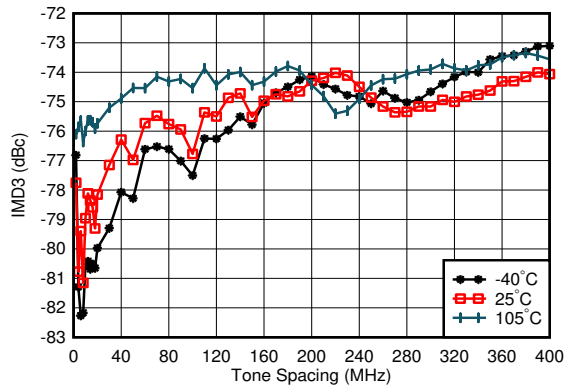

$f_{\text{DAC}} = 11796.48\text{MSPS}$, straight mode, $f_{\text{CENTER}} = 0.85\text{GHz}$, matching at 0.8GHz, -13dBFS each tone, worst channel

Figure 4-27. TX IMD3 vs Tone Spacing and Temperature at 0.85GHz

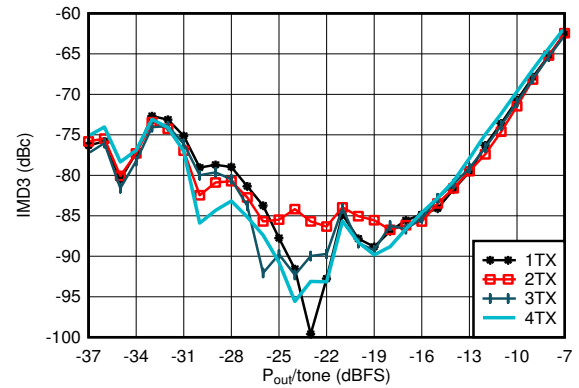

$f_{\text{DAC}} = 5898.24\text{MSPS}$, straight mode, $f_{\text{CENTER}} = 0.85\text{GHz}$, $f_{\text{SPACING}} = 20\text{MHz}$, matching at 0.8GHz

Figure 4-28. TX IMD3 vs Digital Level at 0.85GHz

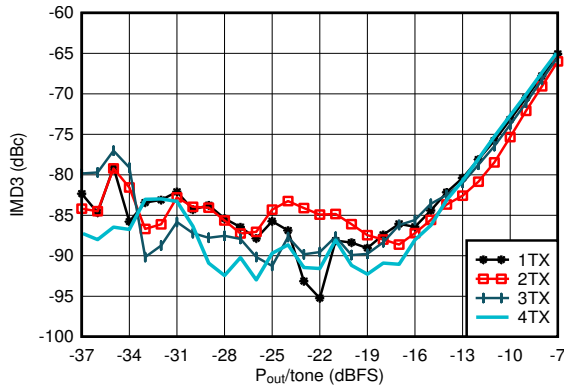

$f_{\text{DAC}} = 8847.36\text{MSPS}$, straight mode, $f_{\text{CENTER}} = 0.85\text{GHz}$, $f_{\text{SPACING}} = 20\text{MHz}$, matching at 0.8GHz

Figure 4-29. TX IMD3 vs Digital Level at 0.85GHz

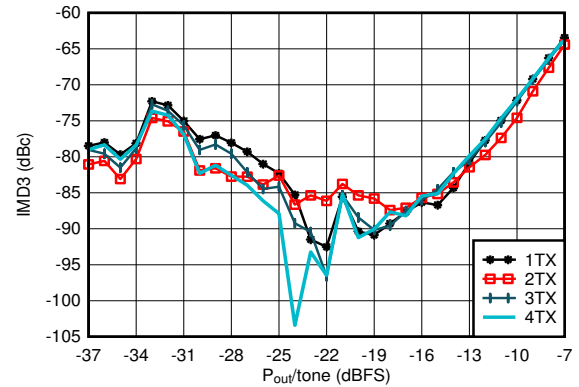

$f_{\text{DAC}} = 11796.48\text{MSPS}$, interleave mode, $f_{\text{CENTER}} = 0.85\text{GHz}$, $f_{\text{SPACING}} = 20\text{MHz}$, matching at 0.8GHz

Figure 4-30. TX IMD3 vs Digital Level at 0.85GHz

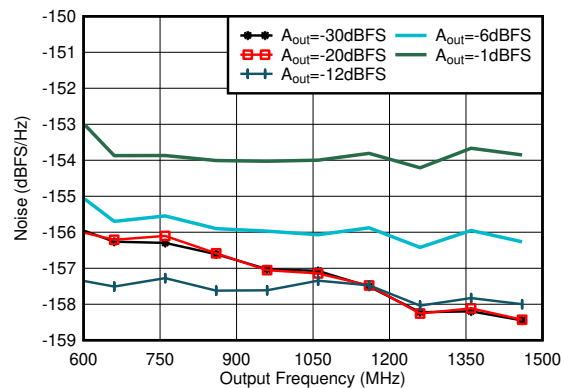

Matching at 2.6GHz, Single tone, $f_{\text{DAC}} = 11.79648\text{GSPS}$, interleave mode, 40MHz offset, DSA = 0dB

Figure 4-31. TX Single Tone Output Noise vs Frequency and Amplitude at 0.85GHz

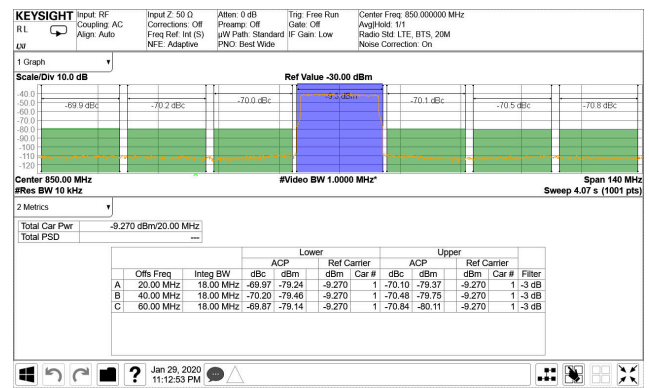

TM1.1, $P_{\text{OUT_RMS}} = -13\text{dBFS}$

Figure 4-32. TX 20-MHz LTE Output Spectrum at 0.85 GHz

4.12.1 TX Typical Characteristics 800MHz (continued)

Typical values at $T_A = +25^\circ\text{C}$ with nominal supplies. Default conditions: TX input data rate = 491.52MSPS, $f_{DAC} = 11796.48\text{MSPS}$ (24x interpolation), interleave mode, 1st Nyquist zone output, PLL clock mode with $f_{REF} = 491.52\text{MHz}$, $A_{OUT} = -1\text{dBFS}$, DSA = 0dB, Sin(x)/x enabled, DSA calibrated

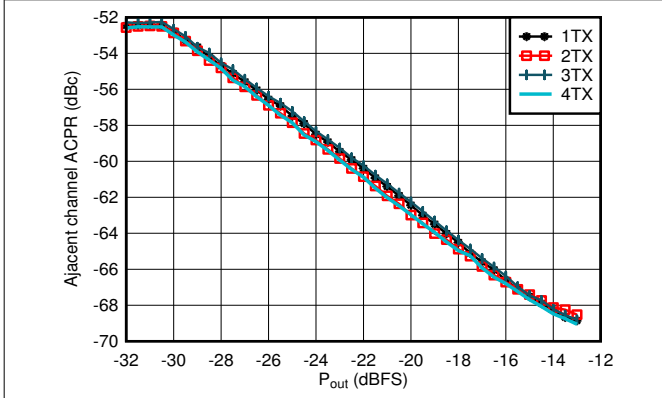

Matching at 0.8GHz, single carrier 20MHz BW TM1.1 LTE

4-33. TX 20-MHz LTE ACPR vs Digital Level at 0.85GHz

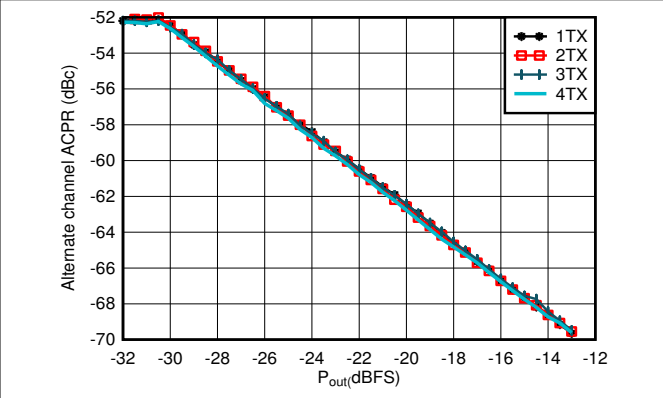

Matching at 0.8GHz, single carrier 20MHz BW TM1.1 LTE

4-34. TX 20MHz LTE alt-ACPR vs Digital Level at 0.85GHz

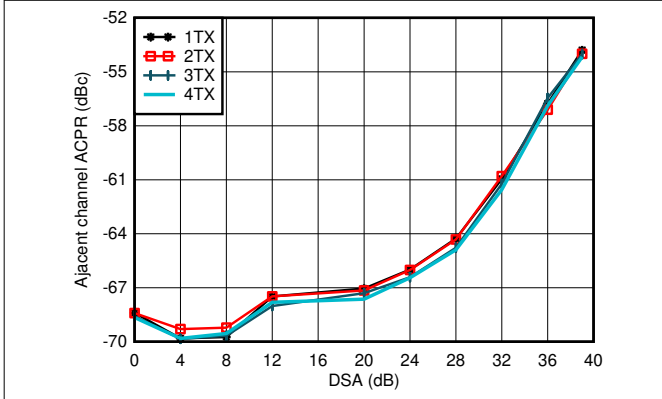

Matching at 0.8GHz, single carrier 20MHz BW TM1.1 LTE

4-35. TX 20MHz LTE ACPR vs DSA at 0.85GHz

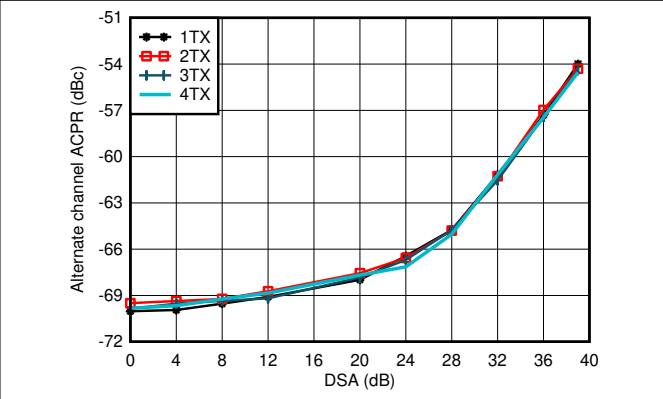

Matching at 0.8GHz, single carrier 20MHz BW TM1.1 LTE

4-36. TX 20-MHz LTE alt-ACPR vs DSA at 0.85GHz

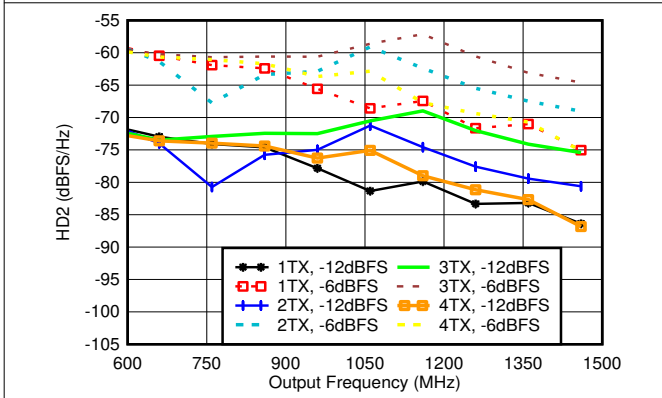

Matching at 0.8GHz, $f_{DAC} = 5898.2\text{GSPS}$, straight mode

4-37. TX HD2 vs Digital Amplitude and Output Frequency at 0.85GHz

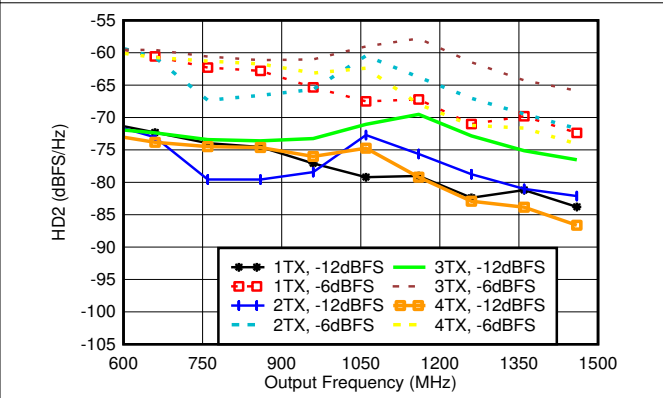

Matching at 0.8GHz, $f_{DAC} = 8847.36\text{GSPS}$, straight mode

4-38. TX HD2 vs Digital Amplitude and Output Frequency at 0.85GHz

4.12.1 TX Typical Characteristics 800MHz (continued)

Typical values at $T_A = +25^\circ\text{C}$ with nominal supplies. Default conditions: TX input data rate = 491.52MSPS, $f_{DAC} = 11796.48\text{MSPS}$ (24x interpolation), interleave mode, 1st Nyquist zone output, PLL clock mode with $f_{REF} = 491.52\text{MHz}$, $A_{OUT} = -1\text{dBFS}$, DSA = 0dB, Sin(x)/x enabled, DSA calibrated

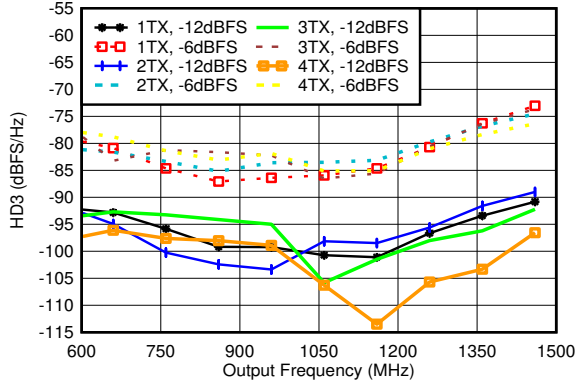

Matching at 0.8GHz, $f_{DAC} = 5898.24\text{MSPS}$, straight mode, normalized to output power at harmonic frequency

4-39. TX HD3 vs Digital Amplitude and Output Frequency at 0.85GHz

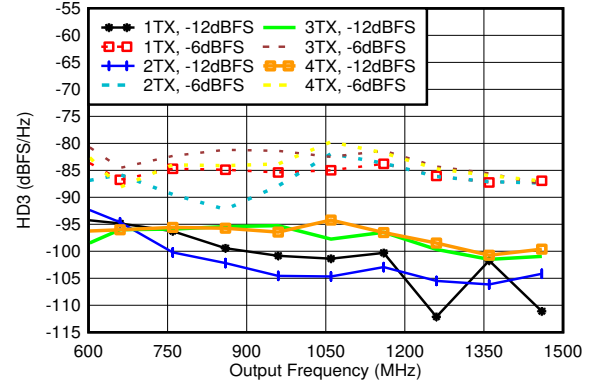

Matching at 0.8GHz, $f_{DAC} = 8847.36\text{MSPS}$, straight mode, normalized to output power at harmonic frequency

4-40. TX HD3 vs Digital Amplitude and Output Frequency at 0.85GHz

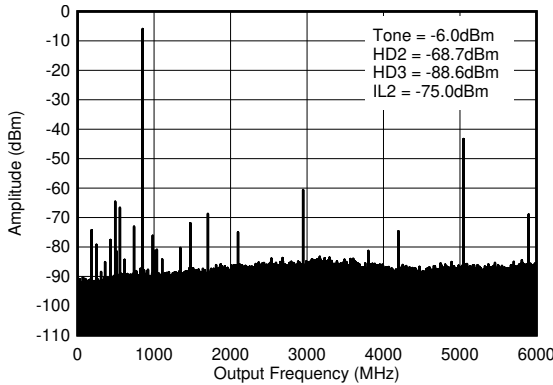

$f_{DAC} = 5898.24\text{MSPS}$, interleave mode, 0.8GHz matching, includes PCB and cable losses. $IL_n = f_s/n \pm f_{OUT}$.

4-41. TX Single Tone (-12 dBFS) Output Spectrum at 0.85GHz ($0-f_{DAC}$)

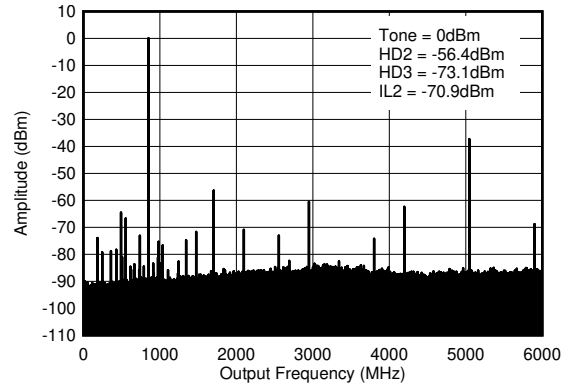

$f_{DAC} = 5898.2\text{MSPS}$, interleave mode, 0.8GHz matching, includes PCB and cable losses. $IL_n = f_s/n \pm f_{OUT}$.

4-42. TX Single Tone (-6dBFS) Output Spectrum at 0.85GHz ($0-f_{DAC}$)

4.12.1 TX Typical Characteristics 800MHz (continued)

Typical values at $T_A = +25^\circ\text{C}$ with nominal supplies. Default conditions: TX input data rate = 491.52MSPS, $f_{\text{DAC}} = 11796.48\text{MSPS}$ (24x interpolation), interleave mode, 1st Nyquist zone output, PLL clock mode with $f_{\text{REF}} = 491.52\text{MHz}$, $A_{\text{OUT}} = -1\text{dBFS}$, DSA = 0dB, Sin(x)/x enabled, DSA calibrated

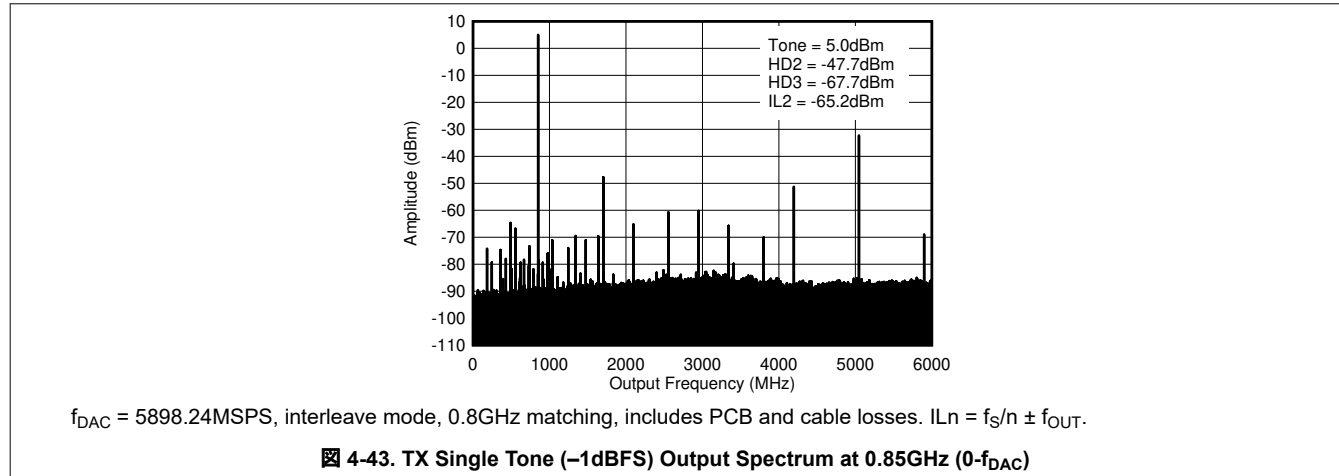

4.12.2 TX Typical Characteristics at 1.8GHz

Typical values at $T_A = +25^\circ\text{C}$ with nominal supplies. Default conditions: TX input data rate = 491.52MSPS, $f_{DAC} = 11796.48\text{MSPS}$ (24x interpolation), interleave mode, 1st Nyquist zone output, PLL clock mode with $f_{REF} = 491.52\text{MHz}$, $A_{OUT} = -1\text{ dBFS}$, DSA = 0dB, $\text{Sin}(x)/x$ enabled, DSA calibrated

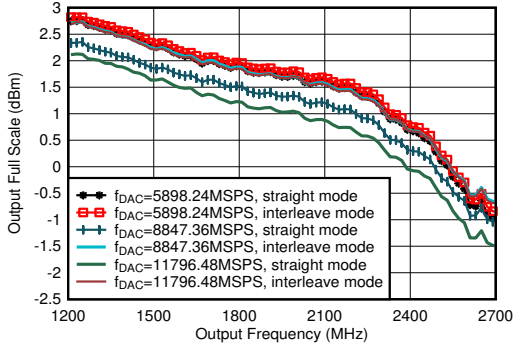

including PCB and cable losses, $A_{out} = -0.5\text{dBFS}$, DSA = 0, 1.8GHz matching

Figure 4-44. TX Output Fullscale vs Output Frequency

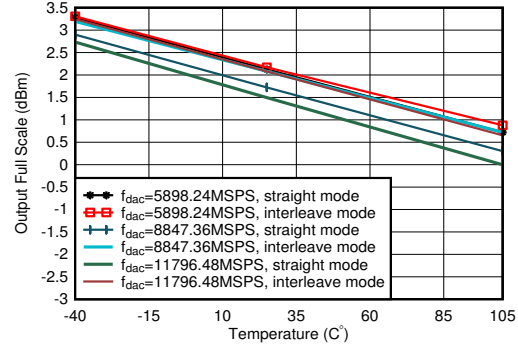

$A_{out} = -0.5\text{dBFS}$, matching 1.8GHz

Figure 4-45. TX Output Power vs Temperature at 1.8GHz

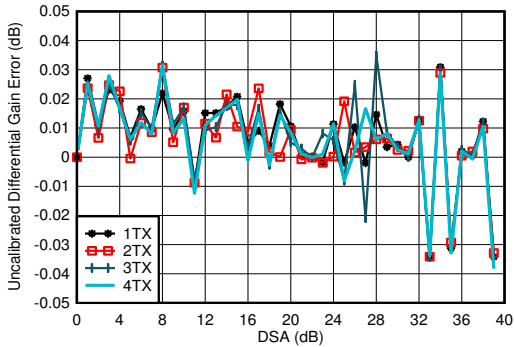

$f_{DAC} = 5898.24\text{MSPS}$, interleave mode, matching at 1.8GHz
Differential Gain Error = $P_{OUT}(\text{DSA Setting} - 1) - P_{OUT}(\text{DSA Setting}) + 1$

Figure 4-46. TX Uncalibrated Differential Gain Error vs DSA Setting and Channel at 1.8GHz

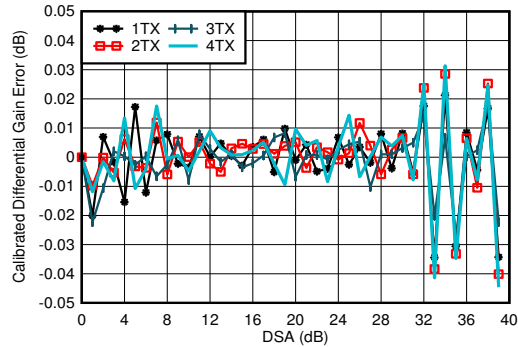

$f_{DAC} = 5898.24\text{MSPS}$, interleave mode, matching at 1.8GHz
Differential Gain Error = $P_{OUT}(\text{DSA Setting} - 1) - P_{OUT}(\text{DSA Setting}) + 1$

Figure 4-47. TX Calibrated Differential Gain Error vs DSA Setting and Channel at 1.8GHz

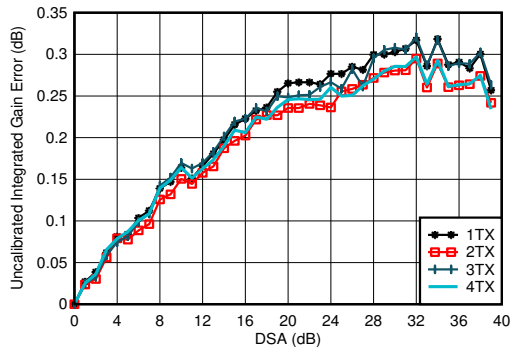

$f_{DAC} = 5898.24\text{MSPS}$, interleave mode, matching at 1.8GHz
Integrated Gain Error = $P_{OUT}(\text{DSA Setting}) - P_{OUT}(\text{DSA Setting} = 0) + (\text{DSA Setting})$

Figure 4-48. TX Uncalibrated Integrated Gain Error vs DSA Setting and Channel at 1.8GHz

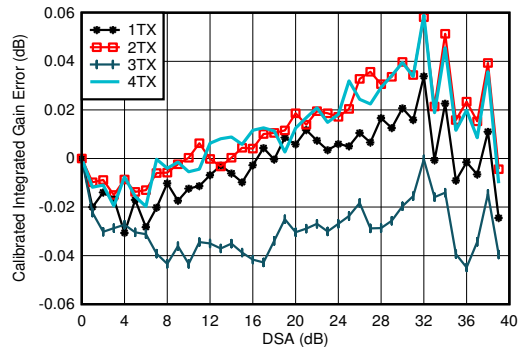

$f_{DAC} = 5898.24\text{MSPS}$, interleave mode, matching at 1.8GHz
Integrated Gain Error = $P_{OUT}(\text{DSA Setting}) - P_{OUT}(\text{DSA Setting} = 0) + (\text{DSA Setting})$

Figure 4-49. TX Calibrated Integrated Gain Error vs DSA Setting and Channel at 1.8GHz

4.12.2 TX Typical Characteristics at 1.8GHz (continued)

Typical values at $T_A = +25^\circ\text{C}$ with nominal supplies. Default conditions: TX input data rate = 491.52MSPS, $f_{\text{DAC}} = 11796.48\text{MSPS}$ (24x interpolation), interleave mode, 1st Nyquist zone output, PLL clock mode with $f_{\text{REF}} = 491.52\text{MHz}$, $A_{\text{OUT}} = -1\text{ dBFS}$, DSA = 0dB, Sin(x)/x enabled, DSA calibrated

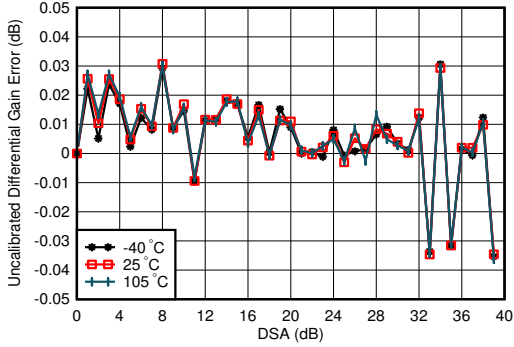

$f_{\text{DAC}} = 5898.24\text{MSPS}$, interleave mode, matching at 1.8GHz
 Differential Gain Error = $P_{\text{OUT}}(\text{DSA Setting} - 1) - P_{\text{OUT}}(\text{DSA Setting}) + 1$

图 4-50. TX Uncalibrated Differential Gain Error vs DSA Setting and Temperature at 1.8GHz

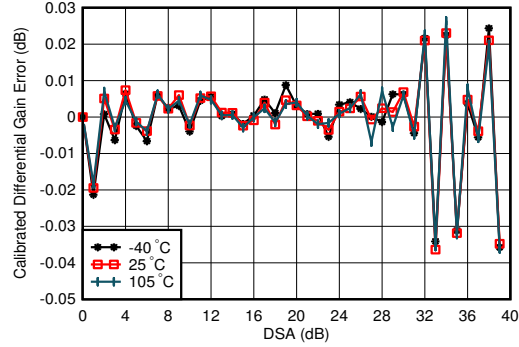

$f_{\text{DAC}} = 5898.24\text{MSPS}$, interleave mode, matching at 1.8GHz
 Differential Gain Error = $P_{\text{OUT}}(\text{DSA Setting} - 1) - P_{\text{OUT}}(\text{DSA Setting}) + 1$

图 4-51. TX Calibrated Differential Gain Error vs DSA Setting and Temperature at 1.8GHz

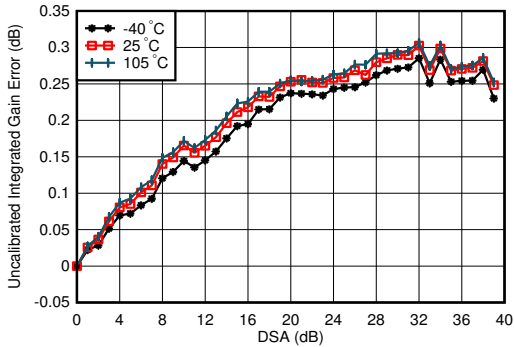

$f_{\text{DAC}} = 5898.24\text{MSPS}$, interleave mode, matching at 1.8GHz
 Integrated Gain Error = $P_{\text{OUT}}(\text{DSA Setting}) - P_{\text{OUT}}(\text{DSA Setting} = 0) + (\text{DSA Setting})$

图 4-52. TX Uncalibrated Integrated Gain Error vs DSA Setting and Temperature at 1.8GHz

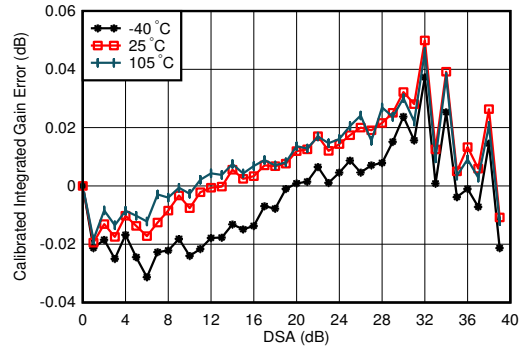

$f_{\text{DAC}} = 5898.24\text{MSPS}$, interleave mode, matching at 1.8GHz
 Integrated Gain Error = $P_{\text{OUT}}(\text{DSA Setting}) - P_{\text{OUT}}(\text{DSA Setting} = 0) + (\text{DSA Setting})$

图 4-53. TX Calibrated Integrated Gain Error vs DSA Setting and Temperature at 1.8GHz

4.12.2 TX Typical Characteristics at 1.8GHz (continued)

Typical values at $T_A = +25^\circ\text{C}$ with nominal supplies. Default conditions: TX input data rate = 491.52MSPS, $f_{\text{DAC}} = 11796.48\text{MSPS}$ (24x interpolation), interleave mode, 1st Nyquist zone output, PLL clock mode with $f_{\text{REF}} = 491.52\text{MHz}$, $A_{\text{OUT}} = -1\text{ dBFS}$, DSA = 0dB, $\text{Sin}(x)/x$ enabled, DSA calibrated

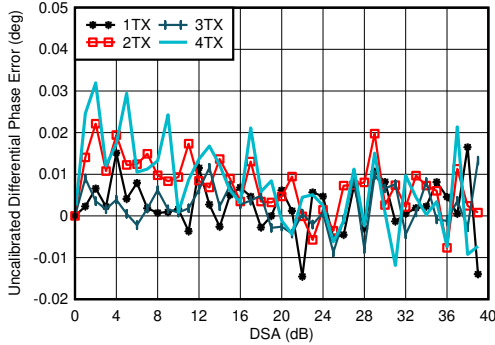

$f_{\text{DAC}} = 5898.24\text{MSPS}$, interleave mode, matching at 1.8GHz
Differential Phase Error = $\text{Phase}_{\text{OUT}}(\text{DSA Setting} - 1) - \text{Phase}_{\text{OUT}}(\text{DSA Setting})$

Figure 4-54. TX Uncalibrated Differential Phase Error vs DSA Setting and Channel at 1.8GHz

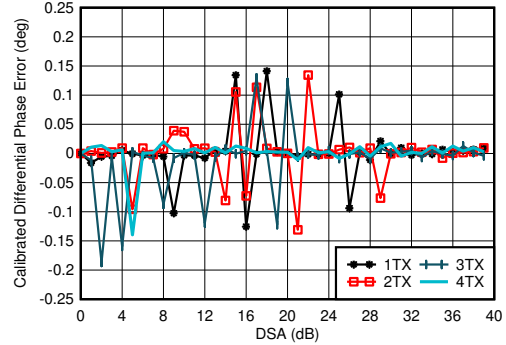

$f_{\text{DAC}} = 8847.36\text{MSPS}$, straight mode, matching at 2.6GHz
Differential Phase Error = $\text{Phase}_{\text{OUT}}(\text{DSA Setting} - 1) - \text{Phase}_{\text{OUT}}(\text{DSA Setting})$

Phase DNL spike may occur at any DSA setting.

Figure 4-55. TX Calibrated Differential Phase Error vs DSA Setting and Channel at 1.8GHz

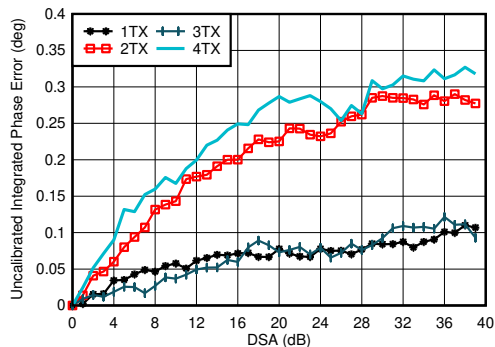

$f_{\text{DAC}} = 5898.24\text{MSPS}$, interleave mode, matching at 1.8GHz
Integrated Phase Error = $\text{Phase}(\text{DSA Setting}) - \text{Phase}(\text{DSA Setting} = 0)$

Figure 4-56. TX Uncalibrated Integrated Phase Error vs DSA Setting and Channel at 1.8GHz

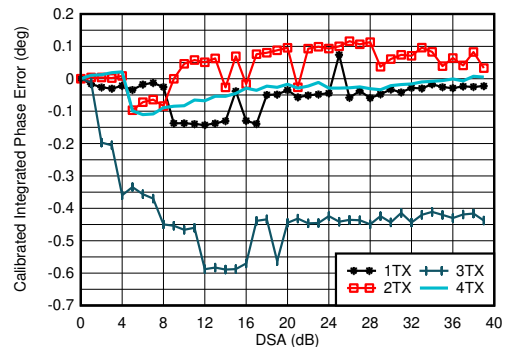

$f_{\text{DAC}} = 5898.24\text{MSPS}$, interleave mode, matching at 1.8GHz
Integrated Phase Error = $\text{Phase}(\text{DSA Setting}) - \text{Phase}(\text{DSA Setting} = 0)$

Figure 4-57. TX Calibrated Integrated Phase Error vs DSA Setting and Channel at 1.8GHz

4.12.2 TX Typical Characteristics at 1.8GHz (continued)

Typical values at $T_A = +25^\circ\text{C}$ with nominal supplies. Default conditions: TX input data rate = 491.52MSPS, $f_{\text{DAC}} = 11796.48\text{MSPS}$ (24x interpolation), interleave mode, 1st Nyquist zone output, PLL clock mode with $f_{\text{REF}} = 491.52\text{MHz}$, $A_{\text{OUT}} = -1\text{ dBFS}$, DSA = 0dB, $\text{Sin}(x)/x$ enabled, DSA calibrated

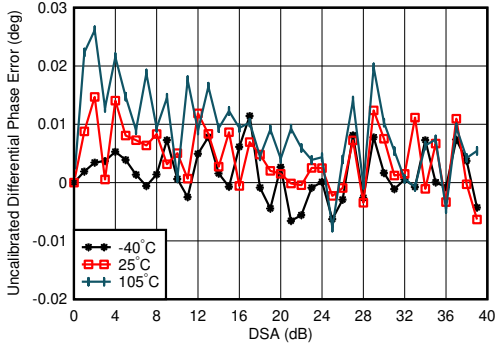

$f_{\text{DAC}} = 5898.24\text{MSPS}$, interleave mode, matching at 1.8GHz
 Differential Phase Error = $\text{Phase}_{\text{OUT}}(\text{DSA Setting} - 1) - \text{Phase}_{\text{OUT}}(\text{DSA Setting})$

图 4-58. TX Uncalibrated Differential Phase Error vs DSA Setting and Temperature at 1.8GHz

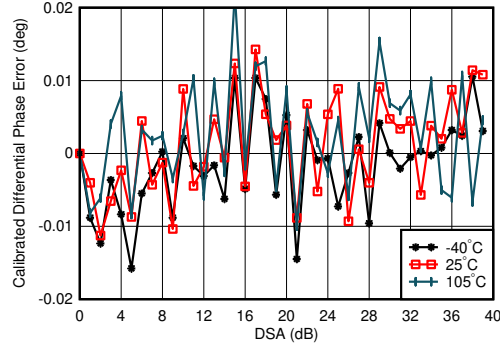

$f_{\text{DAC}} = 5898.24\text{MSPS}$, interleave mode, matching at 1.8GHz, channel with the median variation over DSA setting at 25°C
 Differential Phase Error = $\text{Phase}_{\text{OUT}}(\text{DSA Setting} - 1) - \text{Phase}_{\text{OUT}}(\text{DSA Setting})$

图 4-59. TX Calibrated Differential Phase Error vs DSA Setting and Temperature at 1.8GHz

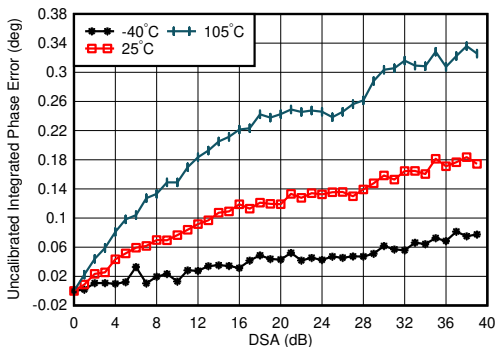

$f_{\text{DAC}} = 5898.24\text{MSPS}$, interleave mode, matching at 1.8GHz, channel with the median variation over DSA setting at 25°C
 Integrated Phase Error = $\text{Phase}(\text{DSA Setting}) - \text{Phase}(\text{DSA Setting} = 0)$

图 4-60. TX Uncalibrated Integrated Phase Error vs DSA Setting and Temperature at 1.8GHz

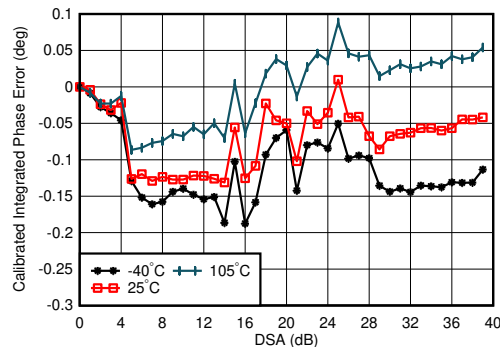

$f_{\text{DAC}} = 5898.24\text{MSPS}$, interleave mode, matching at 1.8GHz, channel with the median variation over DSA setting at 25°C
 Integrated Phase Error = $\text{Phase}(\text{DSA Setting}) - \text{Phase}(\text{DSA Setting} = 0)$

图 4-61. TX Calibrated Integrated Phase Error vs DSA Setting and Temperature at 1.8GHz

4.12.2 TX Typical Characteristics at 1.8GHz (continued)

Typical values at $T_A = +25^\circ\text{C}$ with nominal supplies. Default conditions: TX input data rate = 491.52MSPS, $f_{\text{DAC}} = 11796.48\text{MSPS}$ (24x interpolation), interleave mode, 1st Nyquist zone output, PLL clock mode with $f_{\text{REF}} = 491.52\text{MHz}$, $A_{\text{OUT}} = -1\text{dBFS}$, DSA = 0dB, Sin(x)/x enabled, DSA calibrated

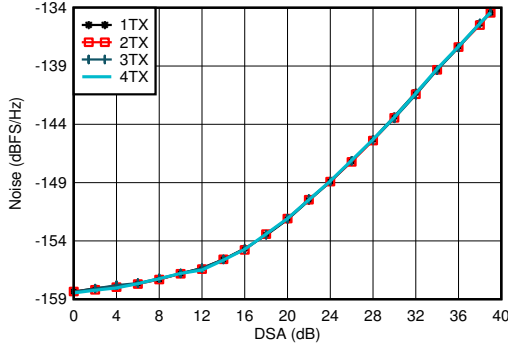

$f_{\text{DAC}} = 5898.24\text{MSPS}$, interleave mode, matching at 1.8GHz, $P_{\text{OUT}} = -13\text{dBFS}$

Figure 4-62. TX Output Noise vs Channel and Attenuation at 1.8GHz

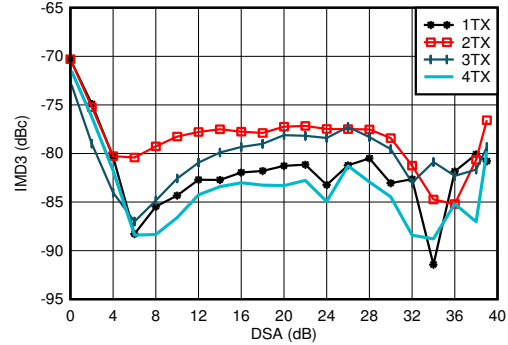

$f_{\text{DAC}} = 11796.48\text{MSPS}$, interleave mode, $f_{\text{CENTER}} = 1.8\text{GHz}$, matching at 1.8GHz, -13dBFS each tone

Figure 4-63. TX IMD3 vs DSA Setting at 1.8GHz

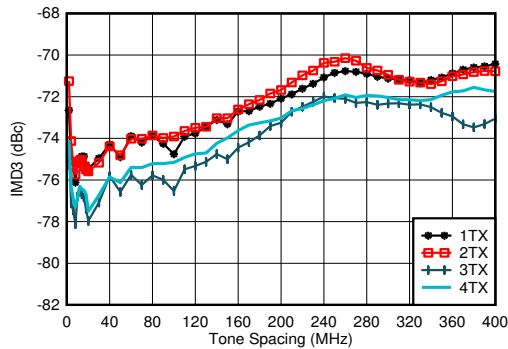

$f_{\text{DAC}} = 11796.48\text{MSPS}$, interleave mode, $f_{\text{CENTER}} = 1.8\text{GHz}$, matching at 1.8GHz, -13dBFS each tone

Figure 4-64. TX IMD3 vs Tone Spacing and Channel at 1.8GHz

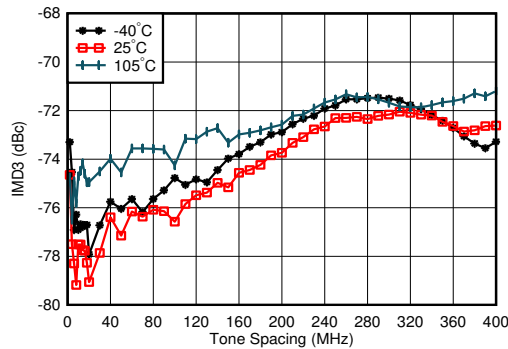

$f_{\text{DAC}} = 11796.48\text{MSPS}$, interleave mode, $f_{\text{CENTER}} = 1.8\text{GHz}$, matching at 1.8GHz, -13dBFS each tone, worst channel

Figure 4-65. TX IMD3 vs Tone Spacing and Temperature at 1.8GHz

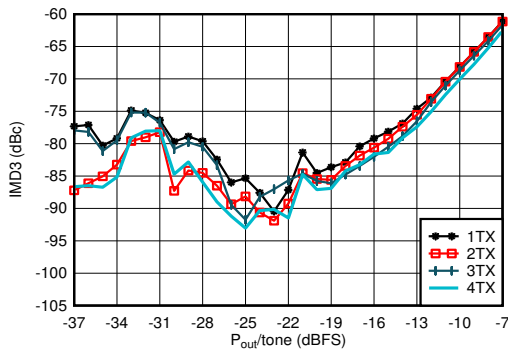

$f_{\text{DAC}} = 11796.48\text{MSPS}$, interleave mode, $f_{\text{CENTER}} = 1.8\text{GHz}$, $f_{\text{SPACING}} = 20\text{MHz}$, matching at 1.8GHz

Figure 4-66. TX IMD3 vs Digital Level at 1.8GHz

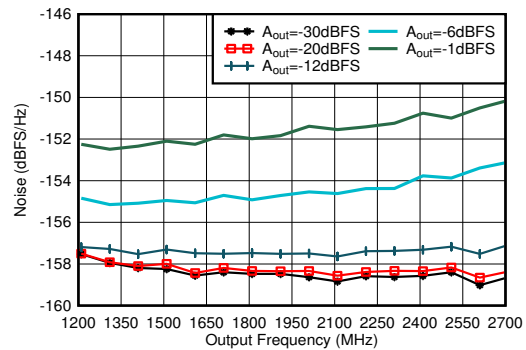

Matching at 2.6GHz, Single tone, $f_{\text{DAC}} = 11.79648\text{GSPS}$, interleave mode, 40MHz offset

Figure 4-67. TX Single Tone Output Noise vs Frequency and Amplitude at 1.8GHz

4.12.2 TX Typical Characteristics at 1.8GHz (continued)

Typical values at $T_A = +25^\circ\text{C}$ with nominal supplies. Default conditions: TX input data rate = 491.52MSPS, $f_{DAC} = 11796.48\text{MSPS}$ (24x interpolation), interleave mode, 1st Nyquist zone output, PLL clock mode with $f_{REF} = 491.52\text{MHz}$, $A_{OUT} = -1\text{dBFS}$, DSA = 0dB, $\text{Sin}(x)/x$ enabled, DSA calibrated

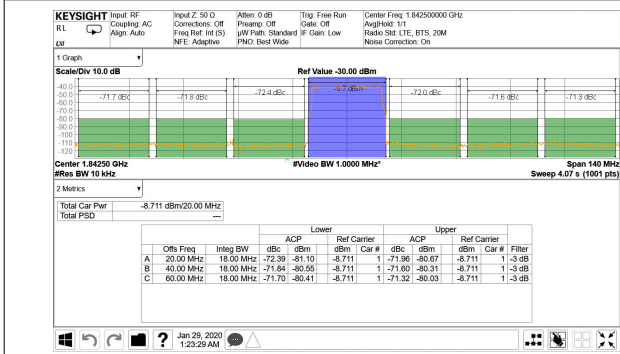

TM1.1, $P_{OUT_RMS} = -13\text{dBFS}$

4-68. TX 20-MHz LTE Output Spectrum at 1.8425GHz

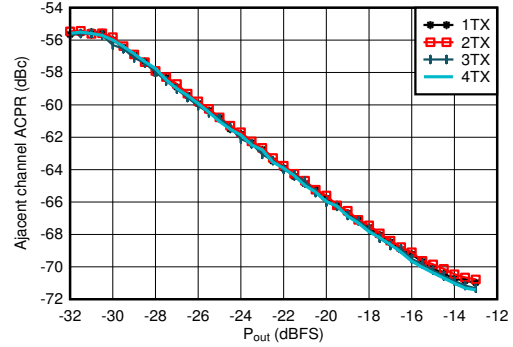

Matching at 1.8GHz, single carrier 20MHz BW TM1.1 LTE

4-69. TX 20MHz LTE ACPR vs Digital Level at 1.8425GHz

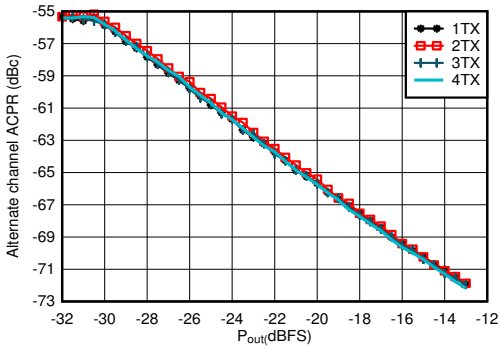

Matching at 1.8GHz, single carrier 20MHz BW TM1.1 LTE

4-70. TX 20MHz LTE alt-ACPR vs Digital Level at 1.8425GHz

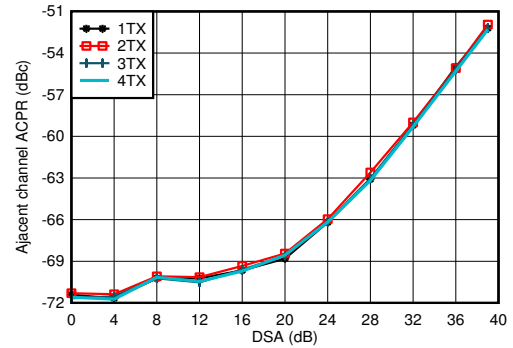

Matching at 1.8GHz, single carrier 20MHz BW TM1.1 LTE

4-71. TX 20MHz LTE ACPR vs DSA at 1.8GHz

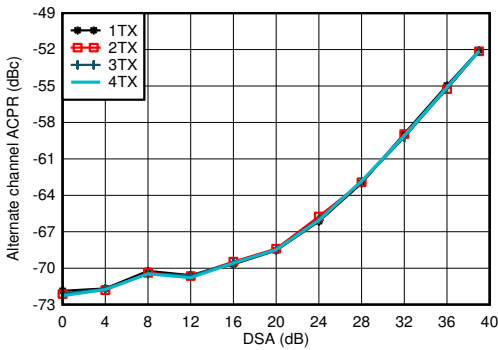

Matching at 1.8GHz, single carrier 20MHz BW TM1.1 LTE

4-72. TX 20MHz LTE alt-ACPR vs DSA at 1.8GHz

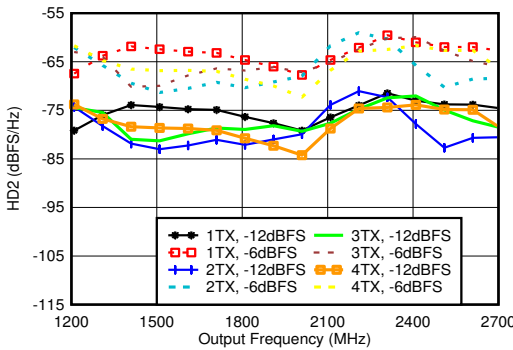

Matching at 1.8GHz, $f_{DAC} = 11.79648\text{GSPS}$, interleave mode, normalized to output power at harmonic frequency

4-73. TX HD2 vs Digital Amplitude and Output Frequency at 1.8GHz

4.12.2 TX Typical Characteristics at 1.8GHz (continued)

Typical values at $T_A = +25^\circ\text{C}$ with nominal supplies. Default conditions: TX input data rate = 491.52MSPS, $f_{DAC} = 11796.48\text{MSPS}$ (24x interpolation), interleave mode, 1st Nyquist zone output, PLL clock mode with $f_{REF} = 491.52\text{MHz}$, $A_{OUT} = -1\text{ dBFS}$, DSA = 0dB, $\text{Sin}(x)/x$ enabled, DSA calibrated

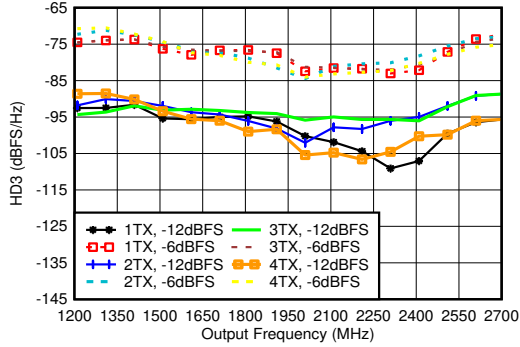

Matching at 1.8GHz, $f_{DAC} = 11.79648\text{GSPS}$, interleave mode, normalized to output power at harmonic frequency

图 4-74. TX HD3 vs Digital Amplitude and Output Frequency at 1.8GHz

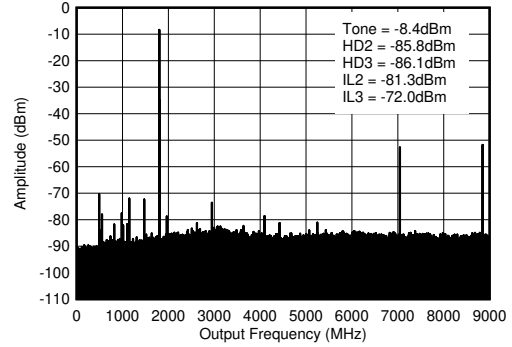

$f_{DAC} = 8847.36\text{MSPS}$, straight mode, 1.8GHz matching, includes PCB and cable losses. $IL_n = f_S/n \pm f_{OUT}$ and is due to mixing with digital clocks.

图 4-75. TX Single Tone (-12 dBFS) Output Spectrum at 1.8GHz ($0-f_{DAC}$)

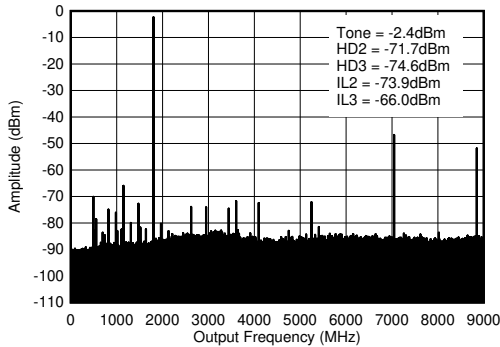

$f_{DAC} = 8847.36\text{MSPS}$, straight mode, 1.8GHz matching, includes PCB and cable losses. $IL_n = f_S/n \pm f_{OUT}$ and is due to mixing with digital clocks.

图 4-76. TX Single Tone (-6 dBFS) Output Spectrum at 1.8GHz ($0-f_{DAC}$)

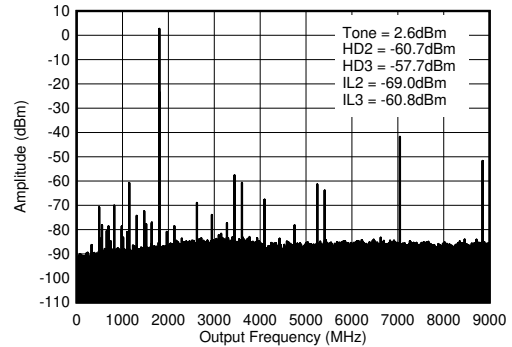

$f_{DAC} = 8847.36\text{MSPS}$, straight mode, 1.8GHz matching, includes PCB and cable losses. $IL_n = f_S/n \pm f_{OUT}$ and is due to mixing with digital clocks.

图 4-77. TX Single Tone (-1dBFS) Output Spectrum at 1.8GHz ($0-f_{DAC}$)

4.12.3 TX Typical Characteristics at 2.6GHz

Typical values at $T_A = +25^\circ\text{C}$ with nominal supplies. Default conditions: TX input data rate = 491.52MSPS, $f_{\text{DAC}} = 11796.48\text{MSPS}$ (24x interpolation), interleave mode, 1st Nyquist zone output, PLL clock mode with $f_{\text{REF}} = 491.52\text{MHz}$, $A_{\text{OUT}} = -1\text{dBFS}$, DSA = 0dB, Sin(x)/x enabled, DSA calibrated

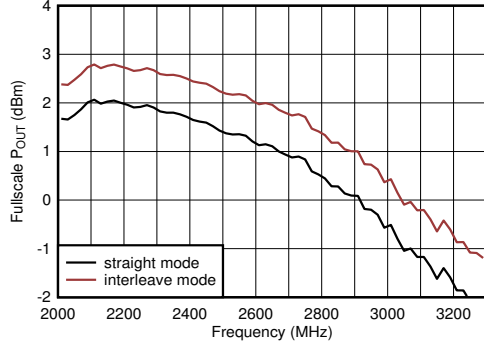

Including PCB and cable losses, $A_{\text{out}} = -0.5\text{dBFS}$, DSA = 0, 2.6GHz matching

4-78. TX Full Scale vs RF Frequency at 11796.48MSPS

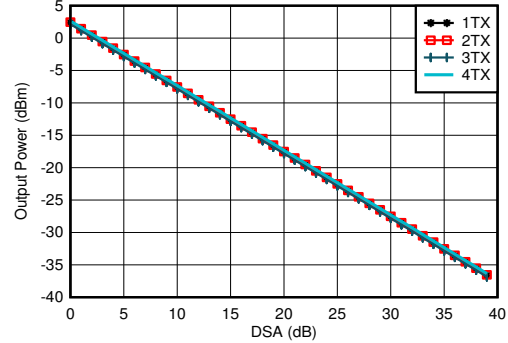

$f_{\text{DAC}} = 8847.36\text{MSPS}$, $A_{\text{out}} = -0.5\text{dBFS}$, matching 2.6GHz

4-79. TX Output Power vs DSA Setting and Channel at 2.6GHz

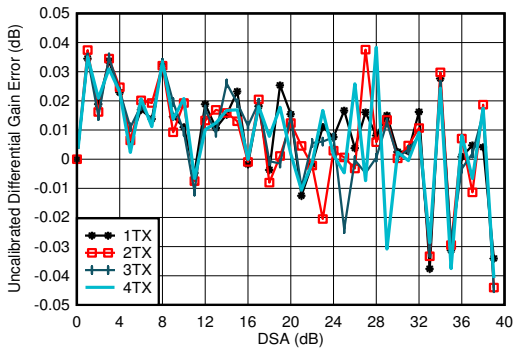

$f_{\text{DAC}} = 8847.36\text{MSPS}$, straight mode, matching at 2.6GHz
Differential Gain Error = $P_{\text{OUT}}(\text{DSA Setting} - 1) - P_{\text{OUT}}(\text{DSA Setting}) + 1$

4-80. TX Uncalibrated Differential Gain Error vs DSA Setting and Channel at 2.6GHz

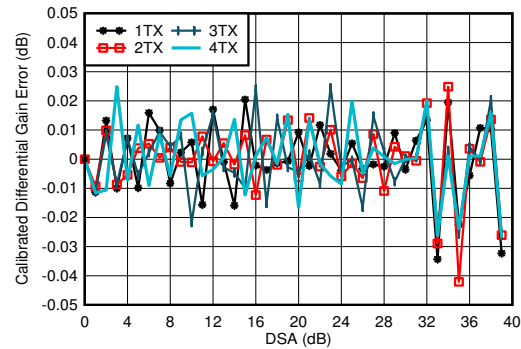

$f_{\text{DAC}} = 8847.36\text{MSPS}$, straight mode, matching at 2.6GHz
Differential Gain Error = $P_{\text{OUT}}(\text{DSA Setting} - 1) - P_{\text{OUT}}(\text{DSA Setting}) + 1$

4-81. TX Calibrated Differential Gain Error vs DSA Setting and Channel at 2.6GHz

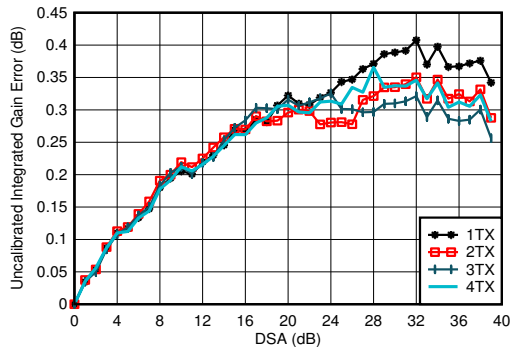

$f_{\text{DAC}} = 8847.36\text{MSPS}$, straight mode, matching at 2.6GHz
Integrated Gain Error = $P_{\text{OUT}}(\text{DSA Setting}) - P_{\text{OUT}}(\text{DSA Setting} = 0) + (\text{DSA Setting})$

4-82. TX Uncalibrated Integrated Gain Error vs DSA Setting and Channel at 2.6GHz

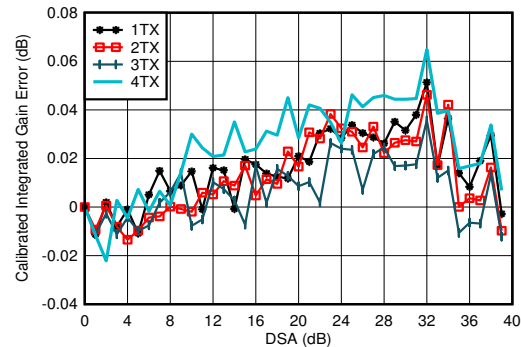

$f_{\text{DAC}} = 8847.36\text{MSPS}$, straight mode, matching at 2.6GHz
Integrated Gain Error = $P_{\text{OUT}}(\text{DSA Setting}) - P_{\text{OUT}}(\text{DSA Setting} = 0) + (\text{DSA Setting})$

4-83. TX Calibrated Integrated Gain Error vs DSA Setting and Channel at 2.6GHz

4.12.3 TX Typical Characteristics at 2.6GHz (continued)

Typical values at $T_A = +25^\circ\text{C}$ with nominal supplies. Default conditions: TX input data rate = 491.52MSPS, $f_{\text{DAC}} = 11796.48\text{MSPS}$ (24x interpolation), interleave mode, 1st Nyquist zone output, PLL clock mode with $f_{\text{REF}} = 491.52\text{MHz}$, $A_{\text{OUT}} = -1\text{dBFS}$, DSA = 0dB, Sin(x)/x enabled, DSA calibrated

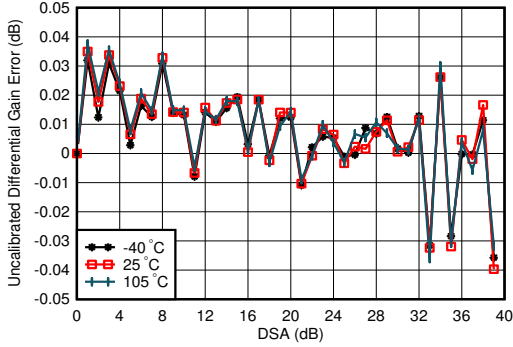

$f_{\text{DAC}} = 8847.36\text{MSPS}$, straight mode, matching at 2.6GHz, channel with the median variation over DSA setting at 25°C
Differential Gain Error = $P_{\text{OUT}}(\text{DSA Setting} - 1) - P_{\text{OUT}}(\text{DSA Setting}) + 1$

图 4-84. TX Uncalibrated Differential Gain Error vs DSA Setting and Temperature at 2.6GHz

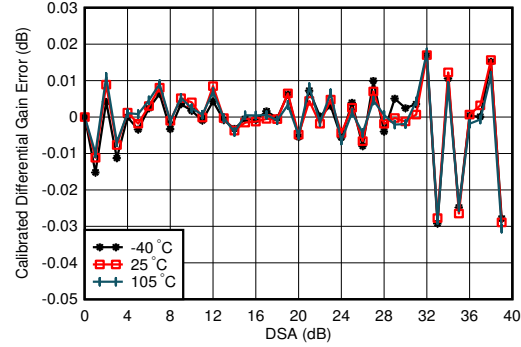

$f_{\text{DAC}} = 8847.36\text{MSPS}$, straight mode, matching at 2.6GHz, channel with the median variation over DSA setting at 25°C
Differential Gain Error = $P_{\text{OUT}}(\text{DSA Setting} - 1) - P_{\text{OUT}}(\text{DSA Setting}) + 1$

图 4-85. TX Calibrated Differential Gain Error vs DSA Setting and Temperature at 2.6GHz

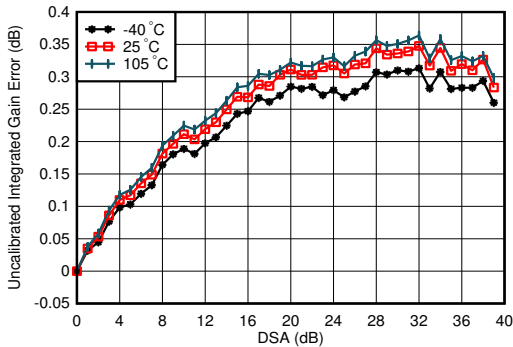

$f_{\text{DAC}} = 8847.36\text{MSPS}$, straight mode, matching at 2.6GHz, channel with the median variation over DSA setting at 25°C
Integrated Gain Error = $P_{\text{OUT}}(\text{DSA Setting}) - P_{\text{OUT}}(\text{DSA Setting} = 0) + (\text{DSA Setting})$

图 4-86. TX Uncalibrated Integrated Gain Error vs DSA Setting and Temperature at 2.6GHz

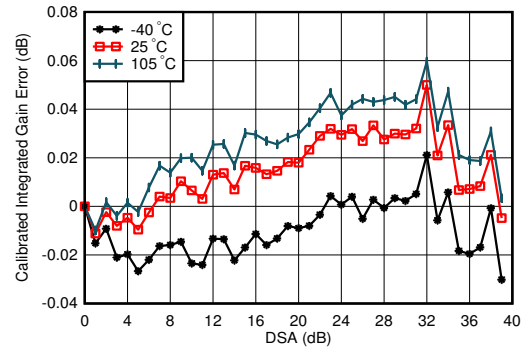

$f_{\text{DAC}} = 8847.36\text{MSPS}$, straight mode, matching at 2.6GHz, channel with the median variation over DSA setting at 25°C
Integrated Gain Error = $P_{\text{OUT}}(\text{DSA Setting}) - P_{\text{OUT}}(\text{DSA Setting} = 0) + (\text{DSA Setting})$

图 4-87. TX Calibrated Integrated Gain Error vs DSA Setting and Temperature at 2.6GHz

4.12.3 TX Typical Characteristics at 2.6GHz (continued)

Typical values at $T_A = +25^\circ\text{C}$ with nominal supplies. Default conditions: TX input data rate = 491.52MSPS, $f_{\text{DAC}} = 11796.48\text{MSPS}$ (24x interpolation), interleave mode, 1st Nyquist zone output, PLL clock mode with $f_{\text{REF}} = 491.52\text{MHz}$, $A_{\text{OUT}} = -1\text{dBFS}$, DSA = 0dB, Sin(x)/x enabled, DSA calibrated

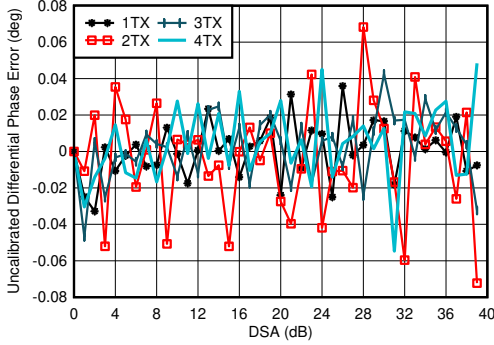

$f_{\text{DAC}} = 8847.36\text{MSPS}$, straight mode, matching at 2.6GHz
 Differential Phase Error = $\text{Phase}_{\text{OUT}}(\text{DSA Setting} - 1) - \text{Phase}_{\text{OUT}}(\text{DSA Setting})$

图 4-88. TX Uncalibrated Differential Phase Error vs DSA Setting and Channel at 2.6GHz

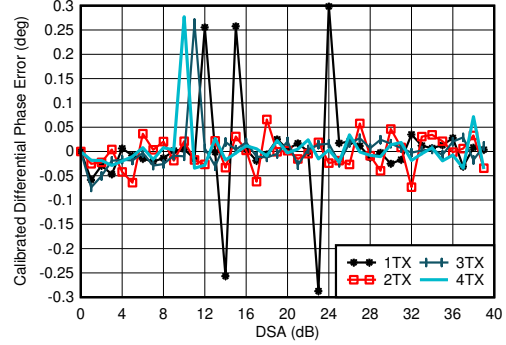

$f_{\text{DAC}} = 8847.36\text{MSPS}$, straight mode, matching at 2.6GHz
 Differential Phase Error = $\text{Phase}_{\text{OUT}}(\text{DSA Setting} - 1) - \text{Phase}_{\text{OUT}}(\text{DSA Setting})$
 Phase DNL spike may occur at any DSA setting.

图 4-89. TX Calibrated Differential Phase Error vs DSA Setting and Channel at 2.6GHz

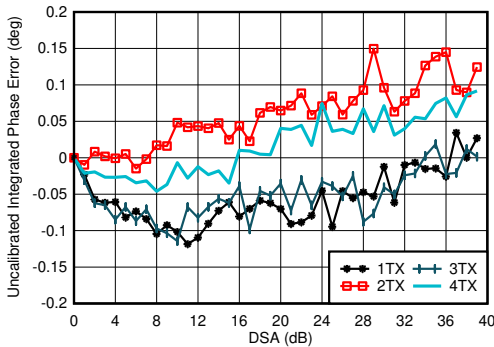

$f_{\text{DAC}} = 8847.36\text{MSPS}$, straight mode, matching at 2.6GHz
 Integrated Phase Error = $\text{Phase}(\text{DSA Setting}) - \text{Phase}(\text{DSA Setting} = 0)$

图 4-90. TX Uncalibrated Integrated Phase Error vs DSA Setting and Channel at 2.6GHz

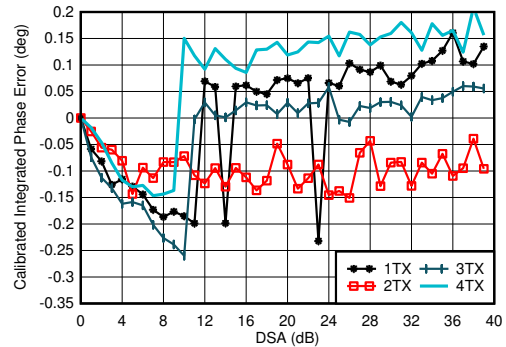

$f_{\text{DAC}} = 8847.36\text{MSPS}$, straight mode, matching at 2.6GHz
 Integrated Phase Error = $\text{Phase}(\text{DSA Setting}) - \text{Phase}(\text{DSA Setting} = 0)$

图 4-91. TX Calibrated Integrated Phase Error vs DSA Setting and Channel at 2.6GHz

4.12.3 TX Typical Characteristics at 2.6GHz (continued)

Typical values at $T_A = +25^\circ\text{C}$ with nominal supplies. Default conditions: TX input data rate = 491.52MSPS, $f_{\text{DAC}} = 11796.48\text{MSPS}$ (24x interpolation), interleave mode, 1st Nyquist zone output, PLL clock mode with $f_{\text{REF}} = 491.52\text{MHz}$, $A_{\text{OUT}} = -1\text{dBFS}$, DSA = 0dB, Sin(x)/x enabled, DSA calibrated

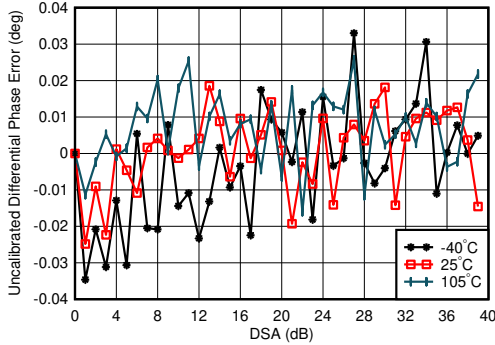

$f_{\text{DAC}} = 8847.36\text{MSPS}$, straight mode, matching at 2.6GHz, channel with the median variation over DSA setting at 25°C
Differential Phase Error = $\text{Phase}_{\text{OUT}}(\text{DSA Setting} - 1) - \text{Phase}_{\text{OUT}}(\text{DSA Setting})$

Figure 4-92. TX Uncalibrated Differential Phase Error vs DSA Setting and Temperature at 2.6GHz

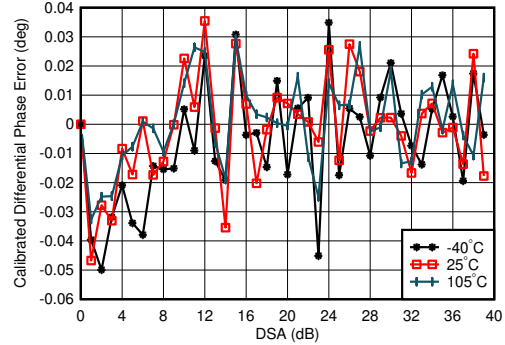

$f_{\text{DAC}} = 8847.36\text{MSPS}$, straight mode, matching at 2.6GHz, channel with the median variation over DSA setting at 25°C
Differential Phase Error = $\text{Phase}_{\text{OUT}}(\text{DSA Setting} - 1) - \text{Phase}_{\text{OUT}}(\text{DSA Setting})$

Figure 4-93. TX Calibrated Differential Phase Error vs DSA Setting and Temperature at 2.6GHz

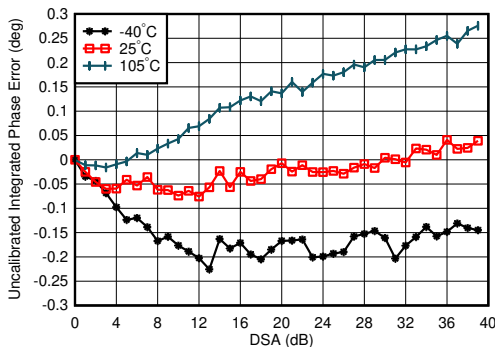

$f_{\text{DAC}} = 8847.36\text{MSPS}$, straight mode, matching at 2.6GHz, channel with the medium variation over DSA setting at 25°C
Integrated Phase Error = $\text{Phase}(\text{DSA Setting}) - \text{Phase}(\text{DSA Setting} = 0)$

Figure 4-94. TX Uncalibrated Integrated Phase Error vs DSA Setting and Temperature at 2.6GHz

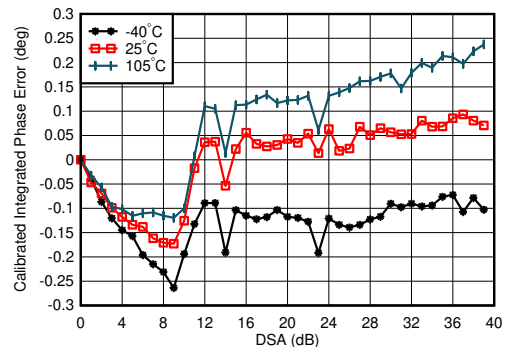

$f_{\text{DAC}} = 8847.36\text{MSPS}$, straight mode, matching at 2.6GHz, channel with the median variation over DSA setting at 25°C
Integrated Phase Error = $\text{Phase}(\text{DSA Setting}) - \text{Phase}(\text{DSA Setting} = 0)$

Figure 4-95. TX Calibrated Integrated Phase Error vs DSA Setting and Temperature at 2.6GHz

4.12.3 TX Typical Characteristics at 2.6GHz (continued)

Typical values at $T_A = +25^\circ\text{C}$ with nominal supplies. Default conditions: TX input data rate = 491.52MSPS, $f_{\text{DAC}} = 11796.48\text{MSPS}$ (24x interpolation), interleave mode, 1st Nyquist zone output, PLL clock mode with $f_{\text{REF}} = 491.52\text{MHz}$, $A_{\text{OUT}} = -1\text{dBFS}$, DSA = 0dB, Sin(x)/x enabled, DSA calibrated

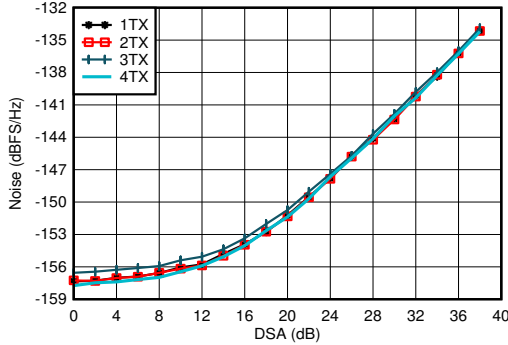

$f_{\text{DAC}} = 8847.36\text{MSPS}$, straight mode, matching at 2.6GHz, $P_{\text{OUT}} = -13\text{ dBFS}$

4-96. TX Output Noise vs Channel and Attenuation at 2.6GHz

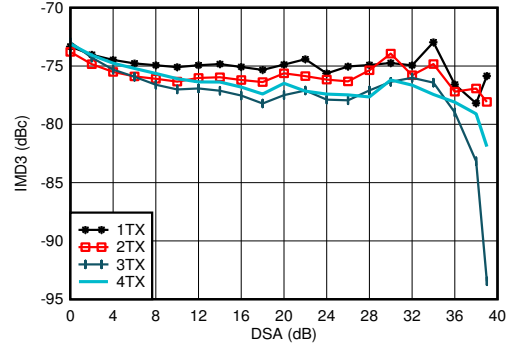

$f_{\text{DAC}} = 8847.36\text{MSPS}$, straight mode, $f_{\text{CENTER}} = 2.6\text{GHz}$, matching at 2.6GHz, -13 dBFS each tone

4-97. TX IMD3 vs DSA Setting at 2.6GHz

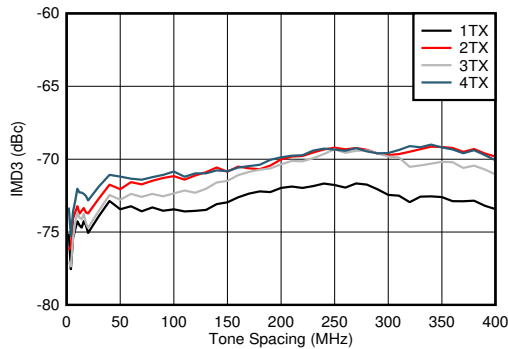

$f_{\text{DAC}} = 8847.36\text{MSPS}$, straight mode, $f_{\text{CENTER}} = 2.6\text{GHz}$, matching at 2.6GHz, -13 dBFS each tone

4-98. TX IMD3 vs Tone Spacing and Channel at 2.6GHz

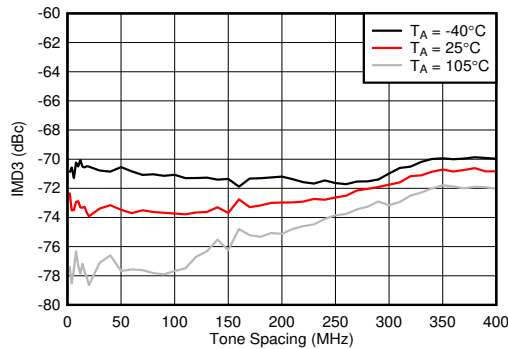

$f_{\text{DAC}} = 8847.36\text{MSPS}$, straight mode, $f_{\text{CENTER}} = 2.6\text{GHz}$, matching at 2.6GHz, -13 dBFS each tone, worst channel.

4-99. TX IMD3 vs Tone Spacing and Temperature at 2.6GHz

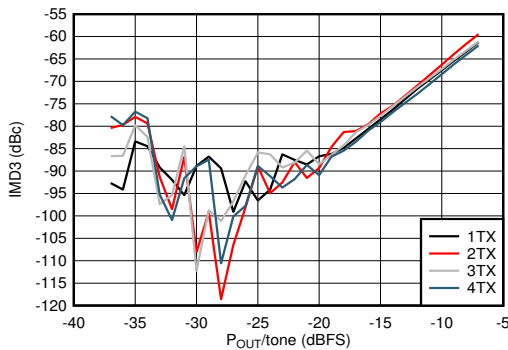

$f_{\text{DAC}} = 8847.36\text{MSPS}$, straight mode, $f_{\text{CENTER}} = 2.6\text{GHz}$, $f_{\text{SPACING}} = 20\text{ MHz}$, matching at 2.6GHz

4-100. TX IMD3 vs Digital Level at 2.6GHz

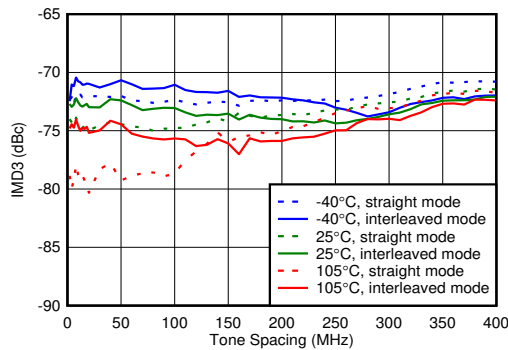

$f_{\text{DAC}} = 8847.36\text{MSPS}$, straight mode, $f_{\text{CENTER}} = 2.6\text{GHz}$, matching at 2.6GHz, -13 dBFS each tone

4-101. TX IMD3 vs Tone Spacing and Temperature

4.12.3 TX Typical Characteristics at 2.6GHz (continued)

Typical values at $T_A = +25^\circ\text{C}$ with nominal supplies. Default conditions: TX input data rate = 491.52MSPS, $f_{DAC} = 11796.48\text{MSPS}$ (24x interpolation), interleave mode, 1st Nyquist zone output, PLL clock mode with $f_{REF} = 491.52\text{MHz}$, $A_{OUT} = -1\text{dBFS}$, DSA = 0dB, Sin(x)/x enabled, DSA calibrated

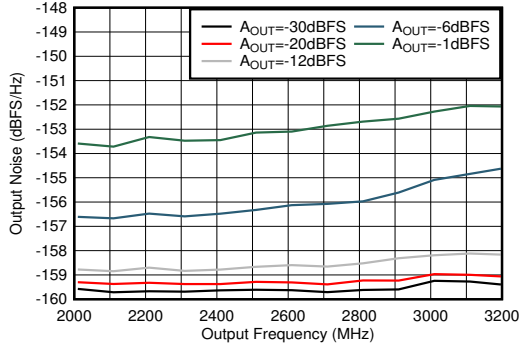

Matching at 2.6GHz, Single tone, $f_{DAC} = 11.79648\text{GSPPS}$, interleave mode, 40-MHz offset

4-102. TX Single Tone Output Noise vs Frequency and Amplitude at 2.6GHz

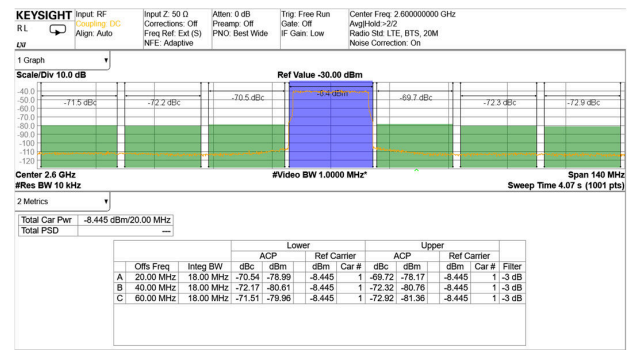

TM1.1, $P_{OUT_RMS} = -13\text{dBFS}$

4-103. TX 20-MHz LTE Output Spectrum at 2.6GHz (Band 41)

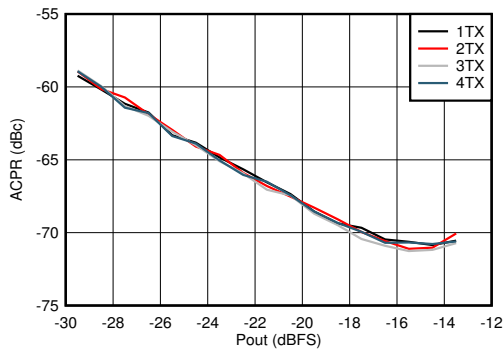

Matching at 2.6GHz, single carrier 20MHz BW TM1.1 LTE

4-104. TX 20-MHz LTE ACPR vs Digital Level at 2.6GHz

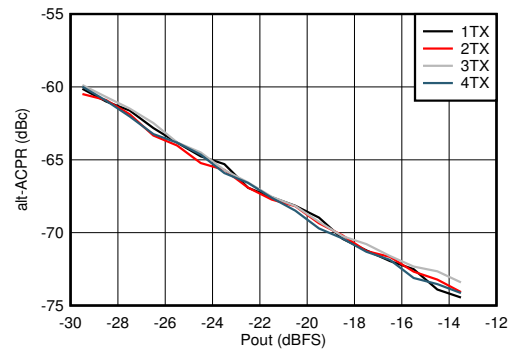

Matching at 2.6GHz, single carrier 20MHz BW TM1.1 LTE

4-105. TX 20-MHz LTE alt-ACPR vs Digital Level at 2.6GHz

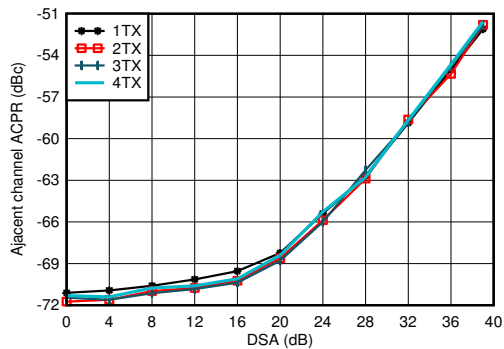

Matching at 2.6GHz, single carrier 20MHz BW TM1.1 LTE

4-106. TX 20-MHz LTE ACPR vs DSA at 2.6GHz

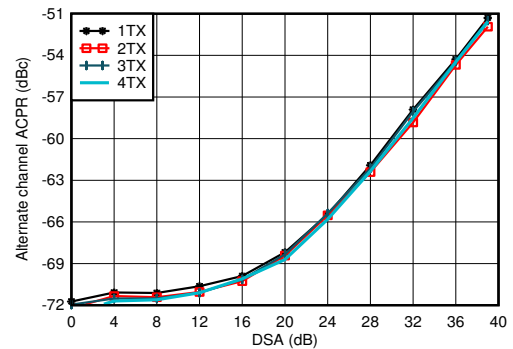

Matching at 2.6GHz, single carrier 20MHz BW TM1.1 LTE

4-107. TX 20-MHz LTE alt-ACPR vs DSA at 2.6GHz

4.12.3 TX Typical Characteristics at 2.6GHz (continued)

Typical values at $T_A = +25^\circ\text{C}$ with nominal supplies. Default conditions: TX input data rate = 491.52MSPS, $f_{DAC} = 11796.48\text{MSPS}$ (24x interpolation), interleave mode, 1st Nyquist zone output, PLL clock mode with $f_{REF} = 491.52\text{MHz}$, $A_{OUT} = -1\text{dBFS}$, DSA = 0dB, Sin(x)/x enabled, DSA calibrated

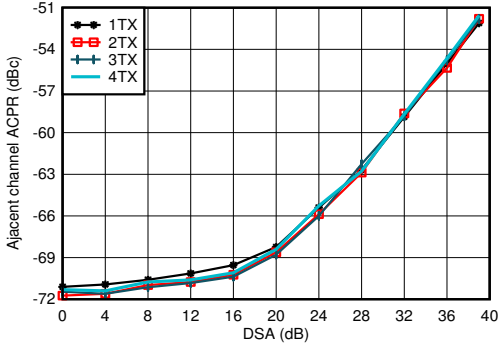

Matching at 2.6GHz, single carrier 20MHz BW TM1.1 LTE

4-108. TX 20-MHz LTE ACPR vs DSA at 2.6GHz

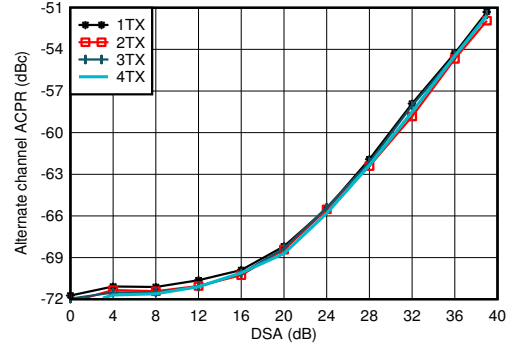

Matching at 2.6GHz, single carrier 20MHz BW TM1.1 LTE

4-109. TX 20-MHz LTE alt-ACPR vs DSA at 2.6GHz

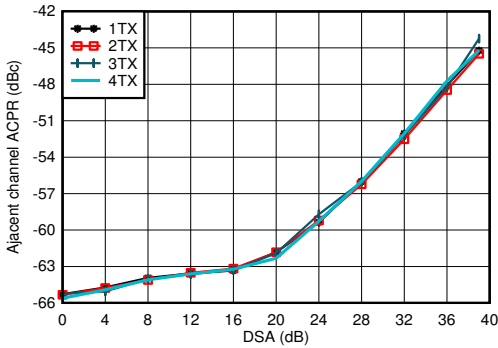

Matching at 2.6GHz, single carrier 100MHz BW TM1.1 NR

4-110. TX 100-MHz NR ACPR vs DSA at 2.6GHz

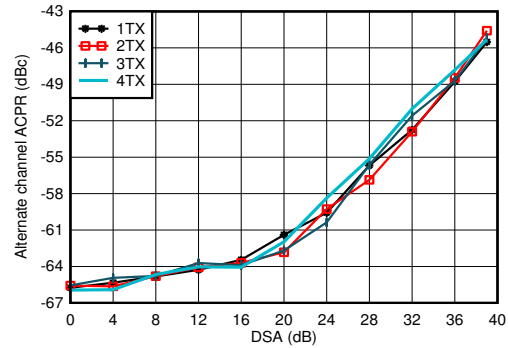

Matching at 2.6GHz, single carrier 100MHz BW TM1.1 NR

4-111. TX 100-MHz NR alt-ACPR vs DSA at 2.6GHz

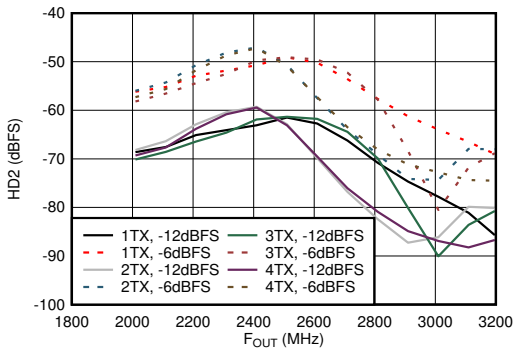

Matching at 2.6GHz, $f_{DAC} = 11.79648\text{GSPS}$, interleave mode, normalized to output power at harmonic frequency

4-112. TX HD2 vs Digital Amplitude and Output Frequency at 2.6GHz

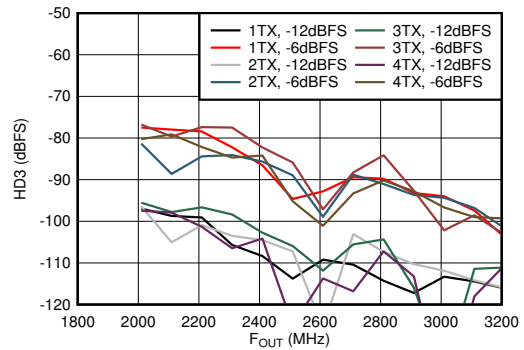

Matching at 2.6GHz, $f_{DAC} = 11.79648\text{GSPS}$, interleave mode, normalized to output power at harmonic frequency

4-113. TX HD3 vs Digital Amplitude and Output Frequency at 2.6GHz

4.12.3 TX Typical Characteristics at 2.6GHz (continued)

Typical values at $T_A = +25^\circ\text{C}$ with nominal supplies. Default conditions: TX input data rate = 491.52MSPS, $f_{\text{DAC}} = 11796.48\text{MSPS}$ (24x interpolation), interleave mode, 1st Nyquist zone output, PLL clock mode with $f_{\text{REF}} = 491.52\text{MHz}$, $A_{\text{OUT}} = -1\text{dBFS}$, DSA = 0dB, Sin(x)/x enabled, DSA calibrated

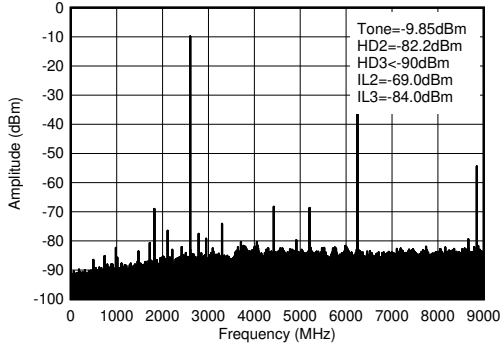

$f_{\text{DAC}} = 8847.36\text{MSPS}$, straight mode, 2.6GHz matching, includes PCB and cable losses. $\text{IL}_n = f_s/n \pm f_{\text{OUT}}$ and is due to mixing with digital clocks.

Figure 4-114. TX Single Tone (-12dBFS) Output Spectrum at 2.6GHz (0- f_{DAC})

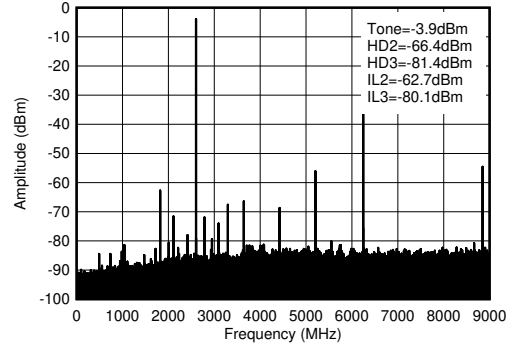

$f_{\text{DAC}} = 8847.36\text{MSPS}$, straight mode, 2.6GHz matching, includes PCB and cable losses. $\text{IL}_n = f_s/n \pm f_{\text{OUT}}$ and is due to mixing with digital clocks.

Figure 4-115. TX Single Tone (-6dBFS) Output Spectrum at 2.6GHz (0- f_{DAC})

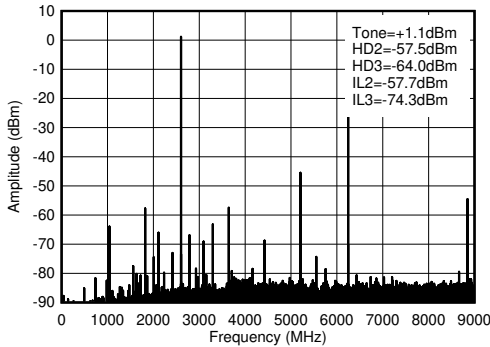

$f_{\text{DAC}} = 8847.36\text{MSPS}$, straight mode, 2.6GHz matching, includes PCB and cable losses. $\text{IL}_n = f_s/n \pm f_{\text{OUT}}$ and is due to mixing with digital clocks.

Figure 4-116. TX Single Tone (-1dBFS) Output Spectrum at 2.6GHz (0- f_{DAC})

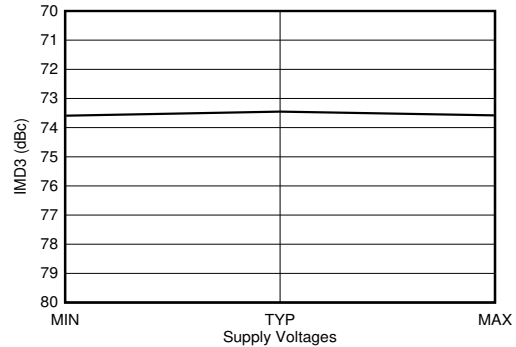

$f_{\text{DAC}} = 11796.48\text{MSPS}$, interleave mode, 2.6GHz matching. 40MHz offset from tone. Output Power = -13dBFS. All supplies simultaneously at MIN, TYP, or MAX voltages.

Figure 4-117. TX IMD3 vs Supply Voltage at 2.6GHz

4.12.4 TX Typical Characteristics at 3.5GHz

Typical values at $T_A = +25^\circ\text{C}$ with nominal supplies. Default conditions: TX input data rate = 491.52MSPS, $f_{\text{DAC}} = 11796.48\text{MSPS}$ (24x interpolation), interleave mode, 1st Nyquist zone output, PLL clock mode with $f_{\text{REF}} = 491.52\text{MHz}$, $A_{\text{OUT}} = -1\text{dBFS}$, DSA = 0dB, Sin(x)/x enabled, DSA calibrated

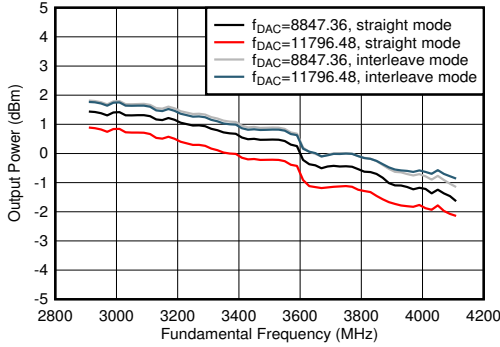

$A_{\text{out}} = -0.5\text{dBFS}$, 3.5GHz Matching, included PCB and cable losses

4-118. TX Output Power vs Frequency

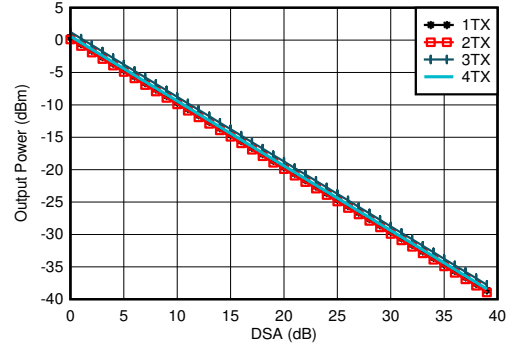

$A_{\text{out}} = -0.5\text{dBFS}$, 3.5GHz Matching, included PCB and cable losses

4-119. TX Output Power vs DSA Setting at 3.5GHz

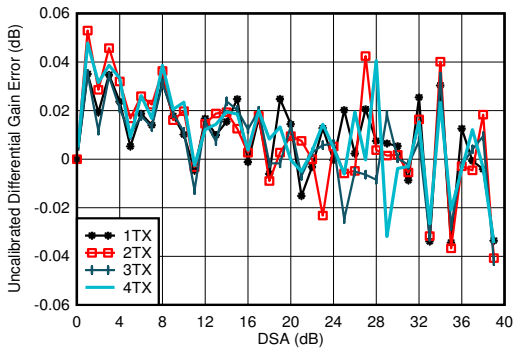

3.5GHz Matching, included PCB and cable losses
Differential Gain Error = $P_{\text{OUT}}(\text{DSA Setting} - 1) - P_{\text{OUT}}(\text{DSA Setting}) + 1$

4-120. TX Uncalibrated Differential Gain Error vs DSA Setting and Channel at 3.5GHz

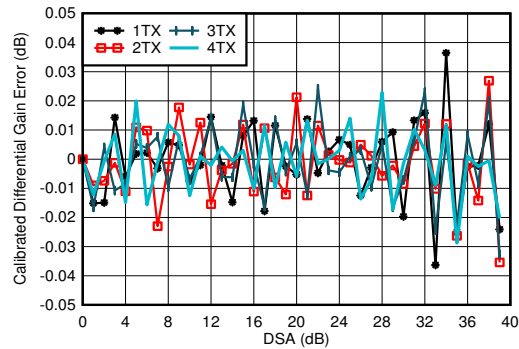

3.5GHz Matching, included PCB and cable losses
Differential Gain Error = $P_{\text{OUT}}(\text{DSA Setting} - 1) - P_{\text{OUT}}(\text{DSA Setting}) + 1$

4-121. TX Calibrated Differential Gain Error vs DSA Setting and Channel at 3.5GHz

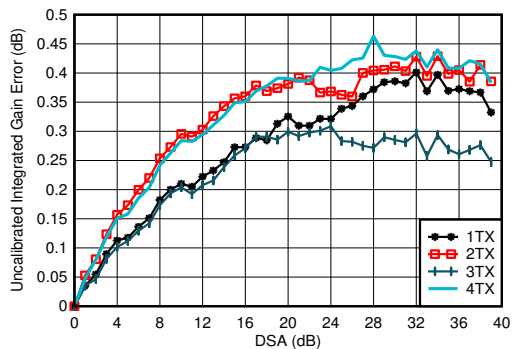

3.5GHz Matching, included PCB and cable losses
Integrated Gain Error = $P_{\text{OUT}}(\text{DSA Setting}) - P_{\text{OUT}}(\text{DSA Setting} = 0) + (\text{DSA Setting})$

4-122. TX Uncalibrated Integrated Gain Error vs DSA Setting and Channel at 3.5GHz

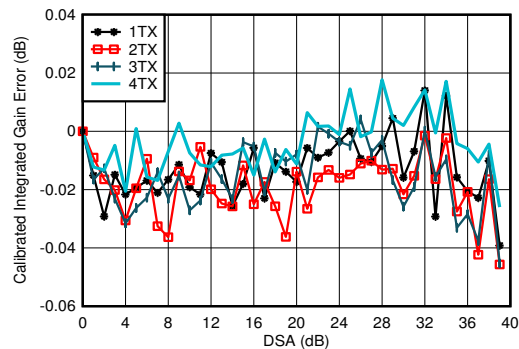

3.5GHz Matching, included PCB and cable losses
Integrated Gain Error = $P_{\text{OUT}}(\text{DSA Setting}) - P_{\text{OUT}}(\text{DSA Setting} = 0) + (\text{DSA Setting})$

4-123. TX Calibrated Integrated Gain Error vs DSA Setting and Channel at 3.5GHz

4.12.4 TX Typical Characteristics at 3.5GHz (continued)

Typical values at $T_A = +25^\circ\text{C}$ with nominal supplies. Default conditions: TX input data rate = 491.52MSPS, $f_{\text{DAC}} = 11796.48\text{MSPS}$ (24x interpolation), interleave mode, 1st Nyquist zone output, PLL clock mode with $f_{\text{REF}} = 491.52\text{MHz}$, $A_{\text{OUT}} = -1\text{dBFS}$, DSA = 0dB, Sin(x)/x enabled, DSA calibrated

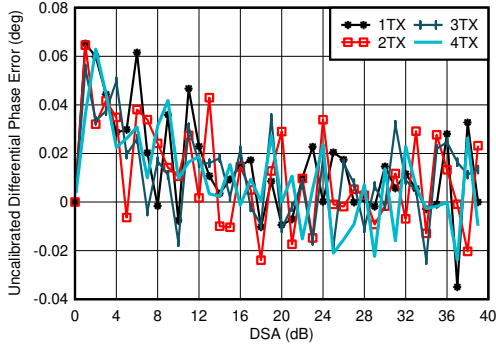

3.5GHz Matching, included PCB and cable losses

Figure 4-124. TX Uncalibrated Differential Phase Error vs DSA Setting and Channel at 3.5GHz

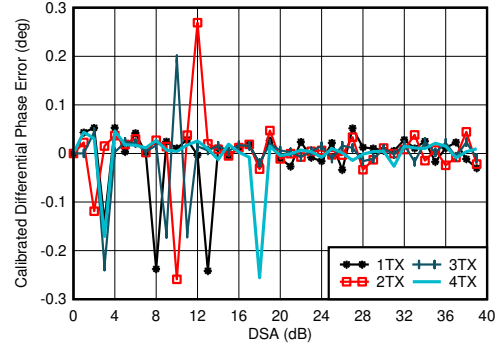

3.5GHz Matching, included PCB and cable losses
Phase DNL spike may occur at any DSA setting.

Figure 4-125. TX Calibrated Differential Phase Error vs DSA Setting and Channel at 3.5GHz

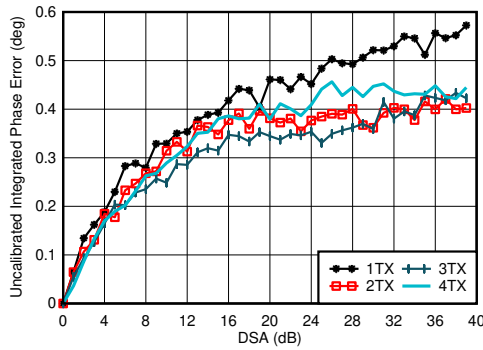

3.5GHz Matching, included PCB and cable losses

Figure 4-126. TX Uncalibrated Integrated Phase Error vs DSA Setting and Channel at 3.5GHz

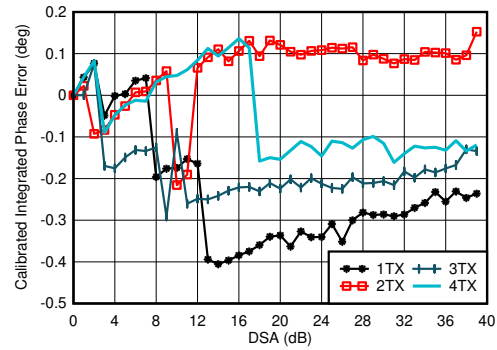

3.5GHz Matching, included PCB and cable losses

Figure 4-127. TX Calibrated Integrated Phase Error vs DSA Setting and Channel at 3.5GHz

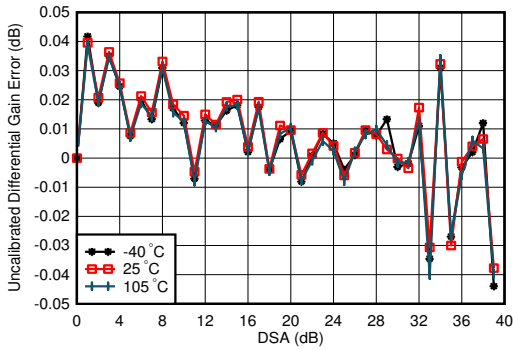

3.5GHz Matching, 1TX

Figure 4-128. TX Uncalibrated Differential Gain Error vs DSA Setting and Temperature at 3.5GHz

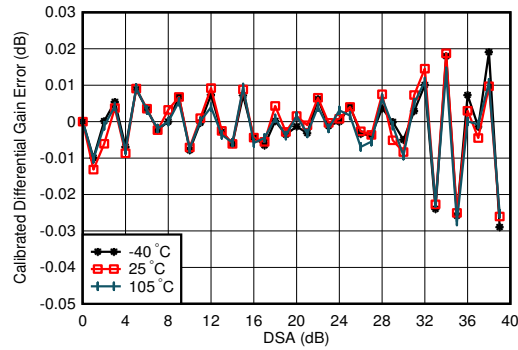

3.5GHz Matching, 1TX, Calibrated at 25°C

Figure 4-129. TX Calibrated Differential Gain Error vs DSA Setting and Temperature at 3.5GHz

4.12.4 TX Typical Characteristics at 3.5GHz (continued)

Typical values at $T_A = +25^\circ\text{C}$ with nominal supplies. Default conditions: TX input data rate = 491.52MSPS, $f_{\text{DAC}} = 11796.48\text{MSPS}$ (24x interpolation), interleave mode, 1st Nyquist zone output, PLL clock mode with $f_{\text{REF}} = 491.52\text{MHz}$, $A_{\text{OUT}} = -1\text{dBFS}$, DSA = 0dB, Sin(x)/x enabled, DSA calibrated

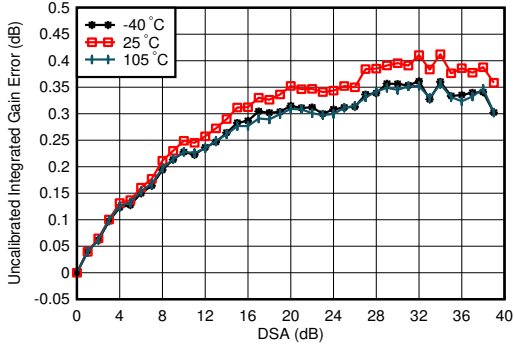

3.5GHz Matching, 1TX

图 4-130. TX Uncalibrated Integrated Gain Error vs DSA Setting and Temperature at 3.5GHz

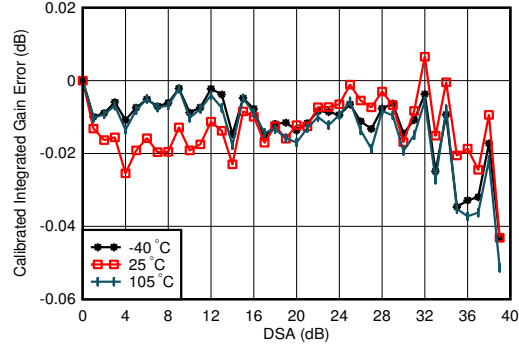

3.5GHz Matching, 1TX, Calibrated at 25°C

图 4-131. TX Calibrated Integrated Gain Error vs DSA Setting and Temperature at 3.5GHz

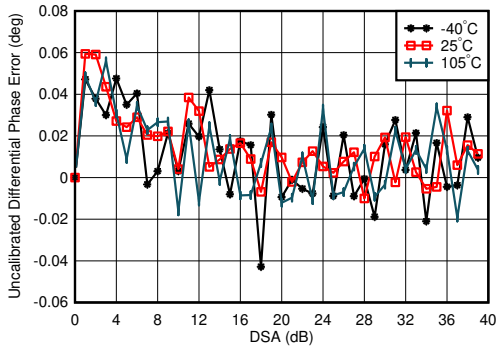

3.5GHz Matching, 1TX

Differential Phase Error = $\text{Phase}_{\text{OUT}}(\text{DSA Setting} - 1) - \text{Phase}_{\text{OUT}}(\text{DSA Setting})$

图 4-132. TX Uncalibrated Differential Phase Error vs DSA setting and Temperature at 3.5GHz

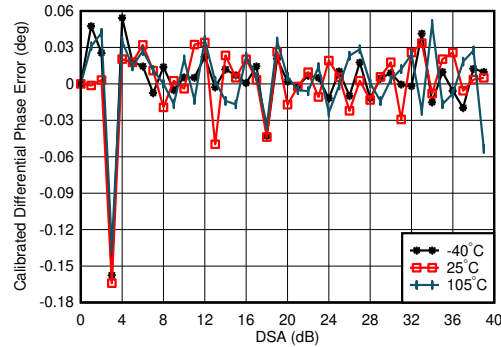

3.5GHz Matching, 1TX, Calibrated at 25°C

Differential Phase Error = $\text{Phase}_{\text{OUT}}(\text{DSA Setting} - 1) - \text{Phase}_{\text{OUT}}(\text{DSA Setting})$

图 4-133. TX Calibrated Differential Phase Error vs DSA Setting and Temperature at 3.5GHz

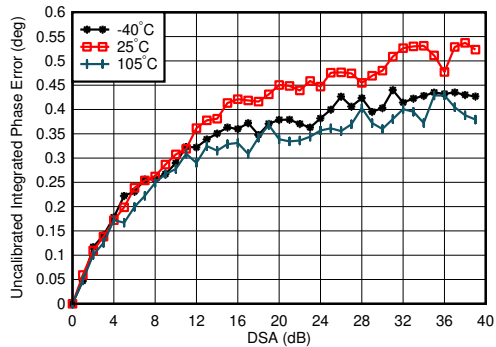

3.5GHz Matching, 1TX

Integrated Phase Error = $\text{Phase}(\text{DSA Setting}) - \text{Phase}(\text{DSA Setting} = 0)$

图 4-134. TX Uncalibrated Integrated Phase Error vs DSA Setting and Temperature at 3.5GHz

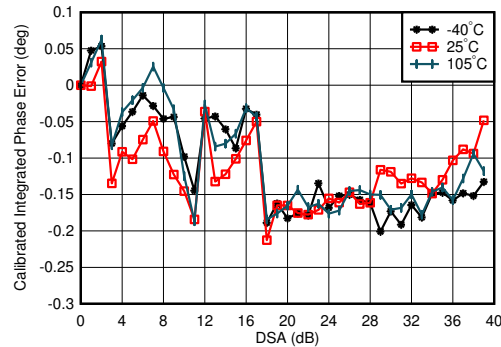

3.5GHz Matching, 1TX, Calibrated at 25°C

Integrated Phase Error = $\text{Phase}(\text{DSA Setting}) - \text{Phase}(\text{DSA Setting} = 0)$

图 4-135. TX Calibrated Integrated Phase Error vs DSA Setting and Temperature at 3.5GHz

4.12.4 TX Typical Characteristics at 3.5GHz (continued)

Typical values at $T_A = +25^\circ\text{C}$ with nominal supplies. Default conditions: TX input data rate = 491.52MSPS, $f_{DAC} = 11796.48\text{MSPS}$ (24x interpolation), interleave mode, 1st Nyquist zone output, PLL clock mode with $f_{REF} = 491.52\text{MHz}$, $A_{OUT} = -1\text{dBFS}$, DSA = 0dB, Sin(x)/x enabled, DSA calibrated

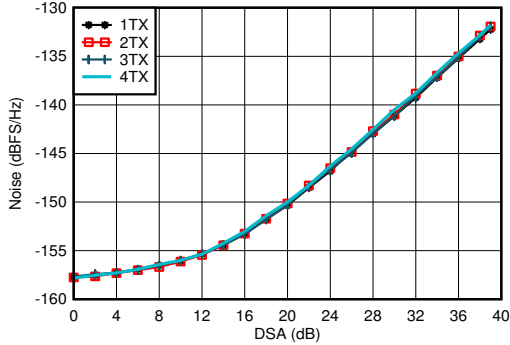

A. $f_{DAC} = 11796.48\text{MSPS}$, interleave mode, matching at 3.5GHz, $A_{out} = -13\text{ dBFS}$.

FIG 4-136. TX NSD vs DSA Setting at 3.5GHz

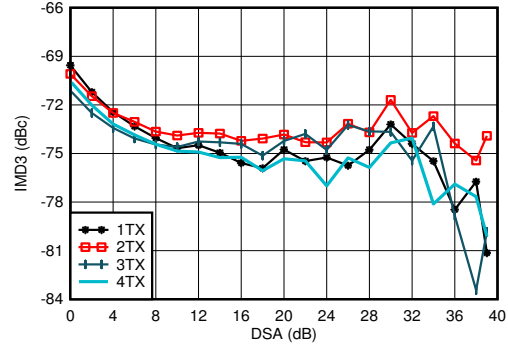

20MHz tone spacing, 3.5GHz Matching, -13 dBFS each tone, included PCB and cable losses

FIG 4-137. TX IMD3 vs DSA Setting at 3.5GHz

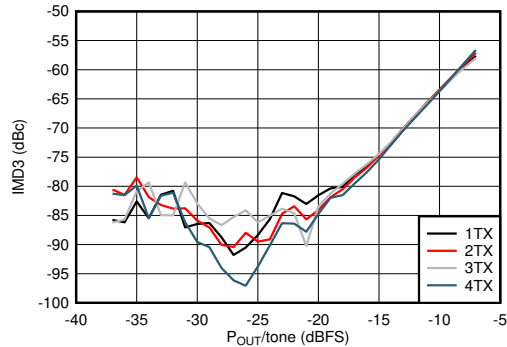

20MHz tone spacing, 3.5GHz Matching

FIG 4-138. TX IMD3 vs Digital Amplitude and Channel at 3.5GHz

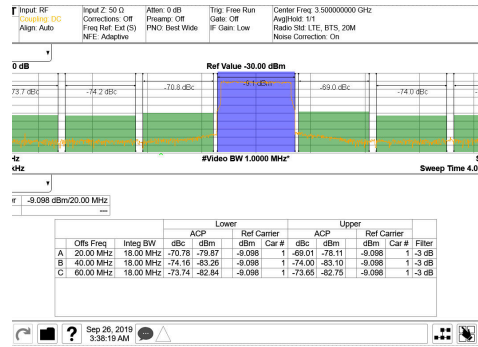

3.5GHz Matching, single carrier 20MHz BW TM1.1 LTE

FIG 4-139. TX 20MHz LTE Output Spectrum at 3.5GHz (Band 42)

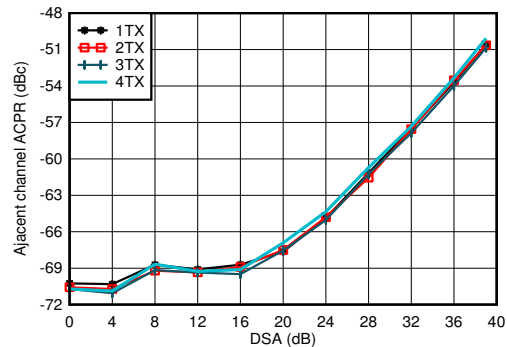

3.5GHz Matching, single carrier 20MHz BW TM1.1 LTE

FIG 4-140. TX 20MHz LTE ACPR vs DSA Setting at 3.5GHz

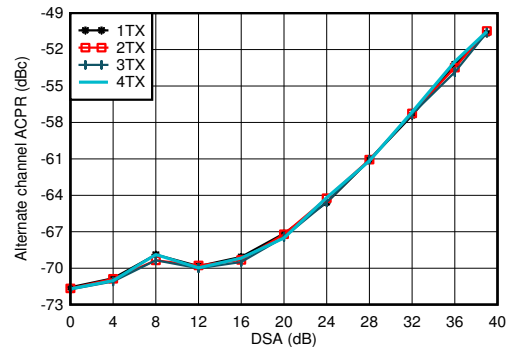

3.5GHz Matching, single carrier 20MHz BW TM1.1 LTE

FIG 4-141. TX 20MHz LTE alt-ACPR vs DSA Setting at 3.5GHz

4.12.4 TX Typical Characteristics at 3.5GHz (continued)

Typical values at $T_A = +25^\circ\text{C}$ with nominal supplies. Default conditions: TX input data rate = 491.52MSPS, $f_{DAC} = 11796.48\text{MSPS}$ (24x interpolation), interleave mode, 1st Nyquist zone output, PLL clock mode with $f_{REF} = 491.52\text{MHz}$, $A_{OUT} = -1\text{dBFS}$, DSA = 0dB, Sin(x)/x enabled, DSA calibrated

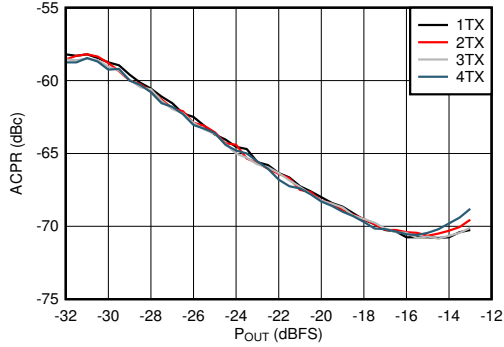

3.5GHz Matching, single carrier 20MHz BW TM1.1 LTE

4-142. TX 20MHz LTE ACPR vs Digital Level at 3.5GHz

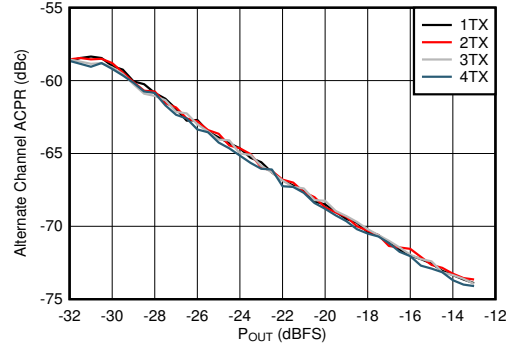

3.5GHz Matching, single carrier 20MHz BW TM1.1 LTE

4-143. TX 20MHz LTE alt-ACPR vs Digital Level at 3.5GHz

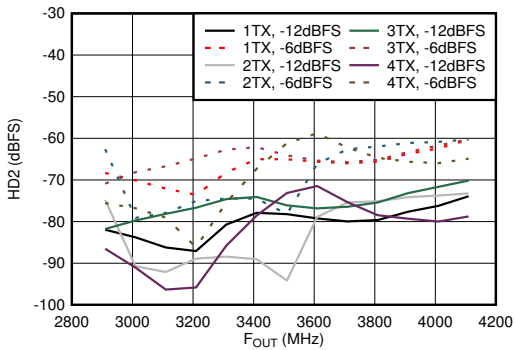

Matching at 3.5GHz, $f_{DAC} = 11.79648\text{GSPS}$, interleave mode, normalized to output power at harmonic frequency

4-144. TX Single Tone HD2 vs Frequency and Digital Level at 3.5GHz

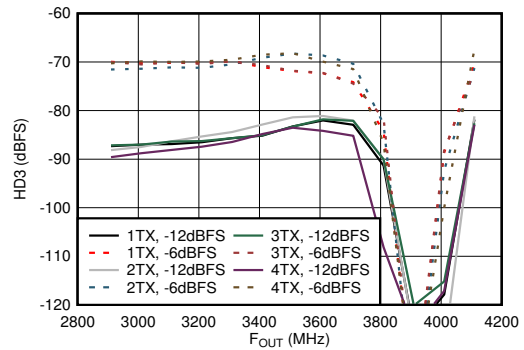

Matching at 3.5GHz, $f_{DAC} = 11.79648\text{GSPS}$, interleave mode, normalized to output power at harmonic frequency. Dip is due to HD3 falling near DC.

4-145. TX Single Tone HD3 vs Frequency and Digital Level at 3.5GHz

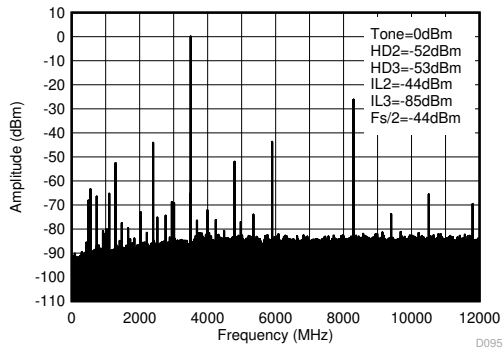

Matching at 3.5GHz, $f_{DAC} = 11.79648\text{GSPS}$, interleave mode.

4-146. TX Single Tone (-1dBFS) Output Spectrum at 3.5GHz (0 - f_{DAC})

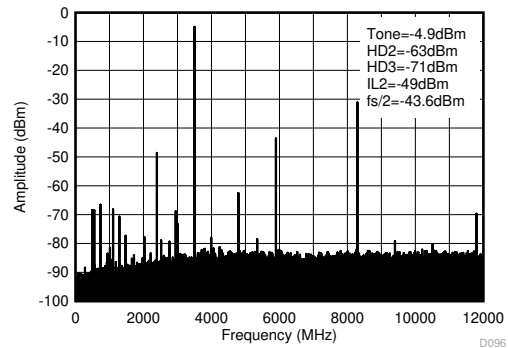

Matching at 3.5GHz, $f_{DAC} = 11.79648\text{GSPS}$, interleave mode.

4-147. TX Single Tone (-6dBFS) Output Spectrum at 3.5GHz (0 - f_{DAC})

4.12.4 TX Typical Characteristics at 3.5GHz (continued)

Typical values at $T_A = +25^\circ\text{C}$ with nominal supplies. Default conditions: TX input data rate = 491.52MSPS, $f_{\text{DAC}} = 11796.48\text{MSPS}$ (24x interpolation), interleave mode, 1st Nyquist zone output, PLL clock mode with $f_{\text{REF}} = 491.52\text{MHz}$, $A_{\text{OUT}} = -1\text{dBFS}$, DSA = 0dB, Sin(x)/x enabled, DSA calibrated

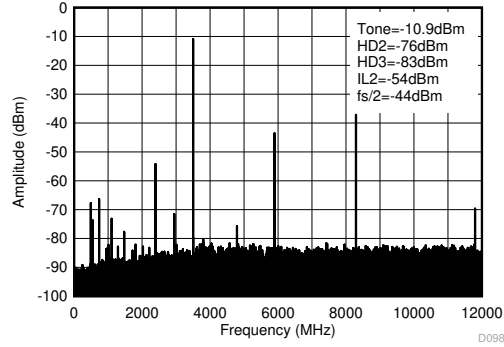

Matching at 3.5GHz, $f_{\text{DAC}} = 11.79648\text{GSPS}$, interleave mode.

4-148. TX Single Tone (-12dBFS) Output Spectrum at 3.5GHz (0- f_{DAC})

4.12.5 TX Typical Characteristics at 4.9GHz

Typical values at $T_A = +25^\circ\text{C}$ with nominal supplies. Default conditions: TX input data rate = 491.52MSPS, $f_{\text{DAC}} = 11796.48\text{MSPS}$ (24x interpolation), interleave mode, 1st Nyquist zone output, PLL clock mode with $f_{\text{REF}} = 491.52\text{MHz}$, $A_{\text{OUT}} = -1\text{dBFS}$, DSA = 0dB, Sin(x)/x enabled, DSA calibrated

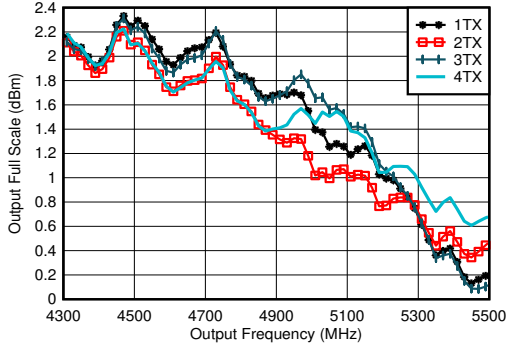

Excluding PCB and cable losses, $A_{\text{out}} = -0.5\text{ dBFS}$, DSA = 0, 4.9GHz matching

图 4-149. TX Full Scale vs RF Frequency and Channel at 11796.48MSPS

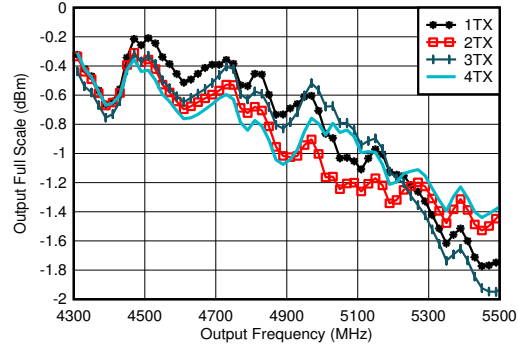

Excluding PCB and cable losses, $A_{\text{out}} = -0.5\text{ dBFS}$, DSA = 0, 4.9GHz matching

图 4-150. TX Full Scale vs RF Frequency and Channel at 5898.24 MSPS, Straight Mode, 2nd Nyquist Zone

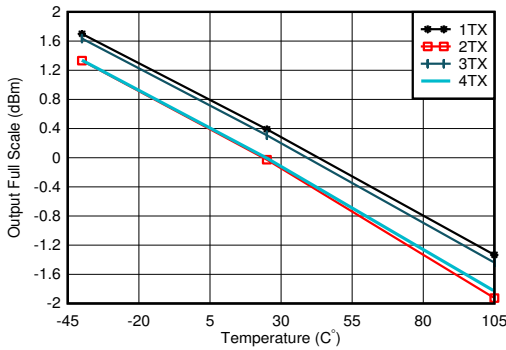

$f_{\text{DAC}} = 11796.48\text{MSPS}$, $A_{\text{out}} = -0.5\text{dBFS}$, matching 4.9GHz

图 4-151. TX Output Power vs DSA Setting and Channel at 4.9GHz

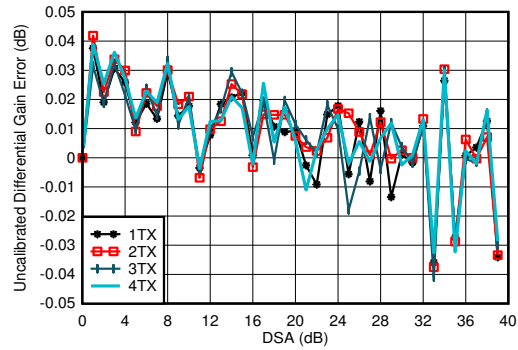

$f_{\text{DAC}} = 11796.48\text{MSPS}$, interleave mode, matching at 4.9GHz
Differential Gain Error = $P_{\text{OUT}}(\text{DSA Setting} - 1) - P_{\text{OUT}}(\text{DSA Setting}) + 1$

图 4-152. TX Uncalibrated Differential Gain Error vs DSA Setting and Channel at 4.9GHz

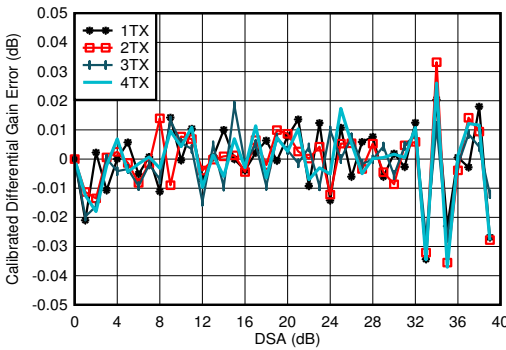

$f_{\text{DAC}} = 11796.48\text{MSPS}$, interleave mode, matching at 4.9GHz
Differential Gain Error = $P_{\text{OUT}}(\text{DSA Setting} - 1) - P_{\text{OUT}}(\text{DSA Setting}) + 1$

图 4-153. TX Calibrated Differential Gain Error vs DSA Setting and Channel at 4.9GHz

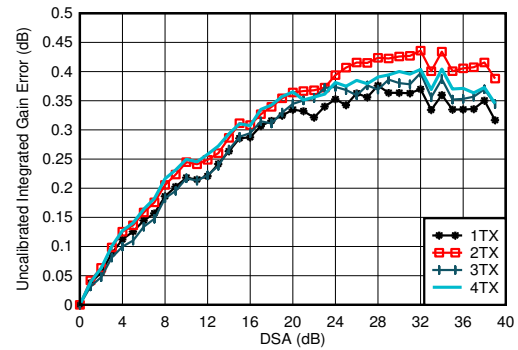

$f_{\text{DAC}} = 11796.48\text{MSPS}$, interleave mode, matching at 4.9GHz
Integrated Gain Error = $P_{\text{OUT}}(\text{DSA Setting}) - P_{\text{OUT}}(\text{DSA Setting} = 0) + (\text{DSA Setting})$

图 4-154. TX Uncalibrated Integrated Gain Error vs DSA Setting and Channel at 4.9GHz

4.12.5 TX Typical Characteristics at 4.9GHz (continued)

Typical values at $T_A = +25^\circ\text{C}$ with nominal supplies. Default conditions: TX input data rate = 491.52MSPS, $f_{\text{DAC}} = 11796.48\text{MSPS}$ (24x interpolation), interleave mode, 1st Nyquist zone output, PLL clock mode with $f_{\text{REF}} = 491.52\text{MHz}$, $A_{\text{OUT}} = -1\text{dBFS}$, DSA = 0dB, Sin(x)/x enabled, DSA calibrated

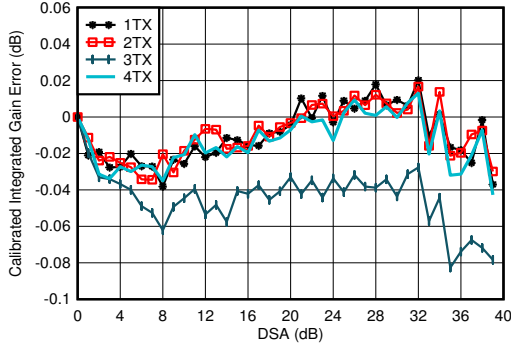

$f_{\text{DAC}} = 11796.48\text{MSPS}$, interleave mode, matching at 4.9GHz
Integrated Gain Error = $P_{\text{OUT}}(\text{DSA Setting}) - P_{\text{OUT}}(\text{DSA Setting} = 0) + (\text{DSA Setting})$

图 4-155. TX Calibrated Integrated Gain Error vs DSA Setting and Channel at 4.9GHz

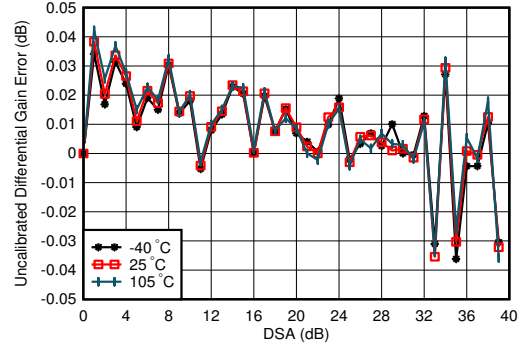

$f_{\text{DAC}} = 11796.48\text{MSPS}$, interleaved mode, matching at 4.9GHz
Differential Gain Error = $P_{\text{OUT}}(\text{DSA Setting} - 1) - P_{\text{OUT}}(\text{DSA Setting}) + 1$

图 4-156. TX Uncalibrated Differential Gain Error vs DSA Setting and Temperature at 4.9GHz

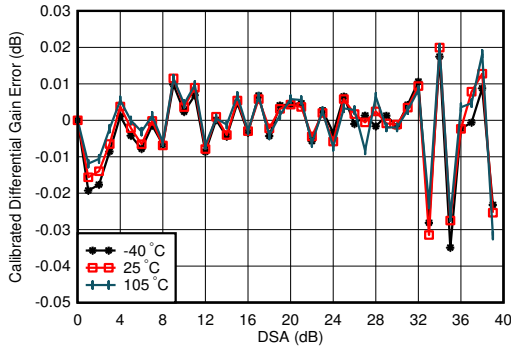

$f_{\text{DAC}} = 11796.48\text{MSPS}$, interleaved mode, matching at 4.9GHz
Differential Gain Error = $P_{\text{OUT}}(\text{DSA Setting} - 1) - P_{\text{OUT}}(\text{DSA Setting}) + 1$

图 4-157. TX Calibrated Differential Gain Error vs DSA Setting and Temperature at 4.9GHz

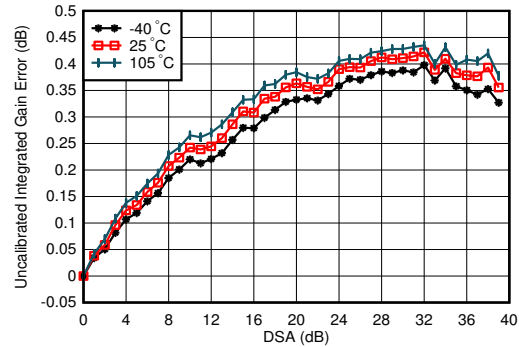

$f_{\text{DAC}} = 11796.48\text{MSPS}$, interleaved mode, matching at 4.9GHz
Integrated Gain Error = $P_{\text{OUT}}(\text{DSA Setting}) - P_{\text{OUT}}(\text{DSA Setting} = 0) + (\text{DSA Setting})$

图 4-158. TX Uncalibrated Integrated Gain Error vs DSA Setting and Temperature at 4.9GHz

4.12.5 TX Typical Characteristics at 4.9GHz (continued)

Typical values at $T_A = +25^\circ\text{C}$ with nominal supplies. Default conditions: TX input data rate = 491.52MSPS, $f_{\text{DAC}} = 11796.48\text{MSPS}$ (24x interpolation), interleaved mode, 1st Nyquist zone output, PLL clock mode with $f_{\text{REF}} = 491.52\text{MHz}$, $A_{\text{OUT}} = -1\text{dBFS}$, DSA = 0dB, Sin(x)/x enabled, DSA calibrated

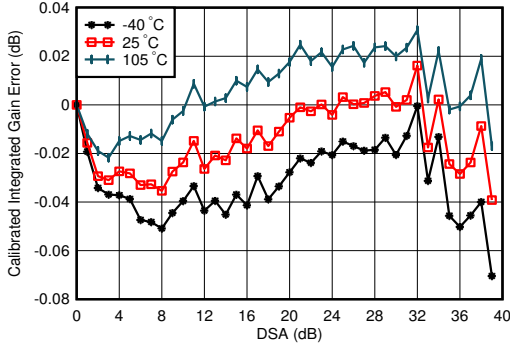

$f_{\text{DAC}} = 11796.48\text{MSPS}$, interleaved mode, matching at 4.9GHz
 Integrated Gain Error = $P_{\text{OUT}}(\text{DSA Setting}) - P_{\text{OUT}}(\text{DSA Setting} = 0) + (\text{DSA Setting})$

Figure 4-159. TX Calibrated Integrated Gain Error vs DSA Setting and Temperature at 4.9GHz

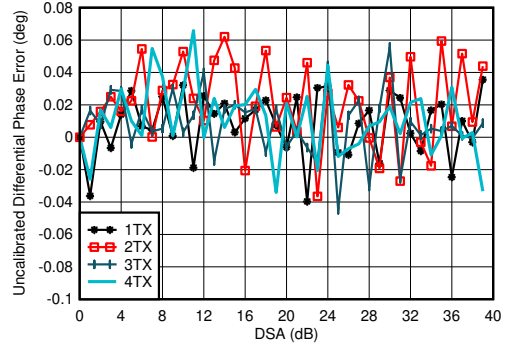

$f_{\text{DAC}} = 11796.48\text{MSPS}$, interleaved mode, matching at 4.9GHz
 Differential Phase Error = $\text{Phase}_{\text{OUT}}(\text{DSA Setting} - 1) - \text{Phase}_{\text{OUT}}(\text{DSA Setting})$

Figure 4-160. TX Uncalibrated Differential Phase Error vs DSA Setting and Channel at 4.9GHz

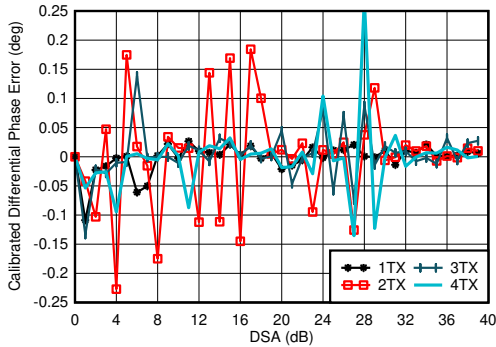

$f_{\text{DAC}} = 11796.48\text{MSPS}$, interleaved mode, matching at 4.9GHz
 Differential Phase Error = $\text{Phase}_{\text{OUT}}(\text{DSA Setting} - 1) - \text{Phase}_{\text{OUT}}(\text{DSA Setting})$
 Phase DNL spike may occur at any DSA setting.

Figure 4-161. TX Calibrated Differential Phase Error vs DSA Setting and Channel at 4.9GHz

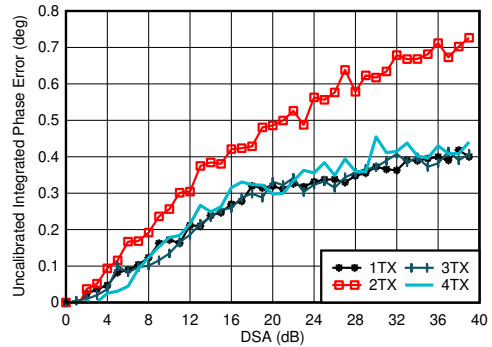

$f_{\text{DAC}} = 11796.48\text{MSPS}$, interleaved mode, matching at 4.9GHz
 Integrated Phase Error = $\text{Phase}(\text{DSA Setting}) - \text{Phase}(\text{DSA Setting} = 0)$

Figure 4-162. TX Uncalibrated Integrated Phase Error vs DSA Setting and Channel at 4.9GHz

4.12.5 TX Typical Characteristics at 4.9GHz (continued)

Typical values at $T_A = +25^\circ\text{C}$ with nominal supplies. Default conditions: TX input data rate = 491.52MSPS, $f_{\text{DAC}} = 11796.48\text{MSPS}$ (24x interpolation), interleaved mode, 1st Nyquist zone output, PLL clock mode with $f_{\text{REF}} = 491.52\text{MHz}$, $A_{\text{OUT}} = -1\text{dBFS}$, DSA = 0dB, Sin(x)/x enabled, DSA calibrated

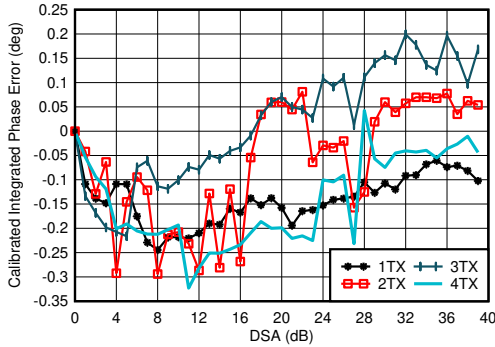

$f_{\text{DAC}} = 11796.48\text{MSPS}$, interleaved mode, matching at 4.9GHz
Integrated Phase Error = Phase(DSA Setting) – Phase(DSA Setting = 0)

Figure 4-163. TX Calibrated Integrated Phase Error vs DSA Setting and Channel at 4.9GHz

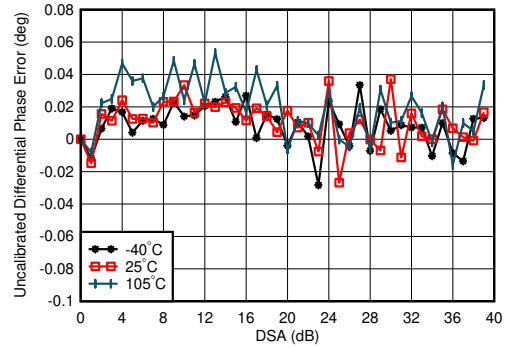

$f_{\text{DAC}} = 11796.48\text{MSPS}$, interleaved mode, matching at 4.9GHz
Differential Phase Error = Phase_{OUT}(DSA Setting – 1) – Phase_{OUT}(DSA Setting)

Figure 4-164. TX Uncalibrated Differential Phase Error vs DSA Setting and Temperature at 4.9GHz

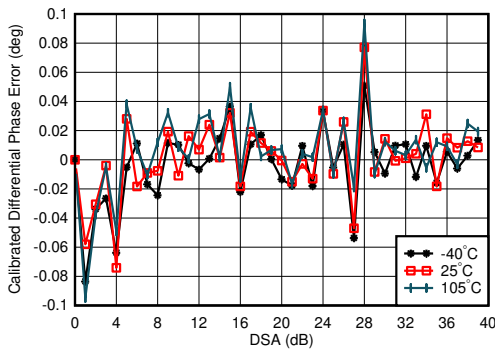

$f_{\text{DAC}} = 11796.48\text{MSPS}$, interleaved mode, matching at 4.9GHz
Differential Phase Error = Phase_{OUT}(DSA Setting – 1) – Phase_{OUT}(DSA Setting)

Figure 4-165. TX Calibrated Differential Phase Error vs DSA Setting and Temperature at 4.9GHz

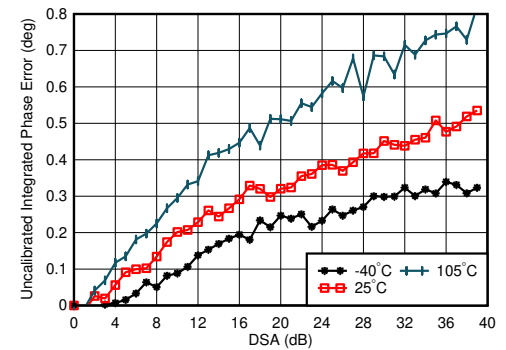

$f_{\text{DAC}} = 11796.48\text{MSPS}$, interleaved mode, matching at 4.9GHz
Integrated Phase Error = Phase(DSA Setting) – Phase(DSA Setting = 0)

Figure 4-166. TX Uncalibrated Integrated Phase Error vs DSA Setting and Temperature at 4.9GHz

4.12.5 TX Typical Characteristics at 4.9GHz (continued)

Typical values at $T_A = +25^\circ\text{C}$ with nominal supplies. Default conditions: TX input data rate = 491.52MSPS, $f_{DAC} = 11796.48\text{MSPS}$ (24x interpolation), interleaved mode, 1st Nyquist zone output, PLL clock mode with $f_{REF} = 491.52\text{MHz}$, $A_{OUT} = -1\text{dBFS}$, DSA = 0dB, Sin(x)/x enabled, DSA calibrated

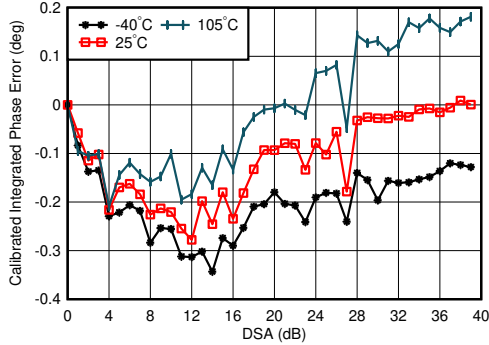

$f_{DAC} = 11796.48\text{MSPS}$, interleaved mode, matching at 4.9GHz, channel with the median variation over DSA setting at 25°C
Integrated Phase Error = Phase(DSA Setting) – Phase(DSA Setting = 0)

4-167. TX Calibrated Integrated Phase Error vs DSA Setting and Temperature at 4.9GHz

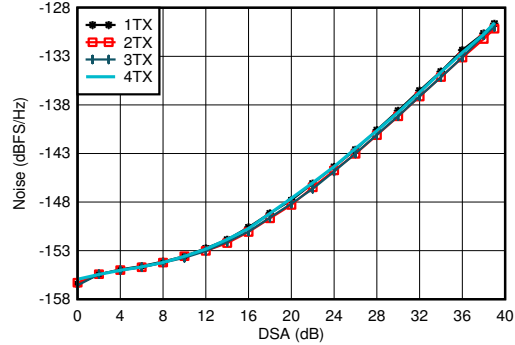

$f_{DAC} = 11796.48\text{MSPS}$, interleaved mode, matching at 4.9GHz, $P_{OUT} = -13\text{dBFS}$

4-168. TX Output Noise vs Channel and Attenuation at 2.6GHz

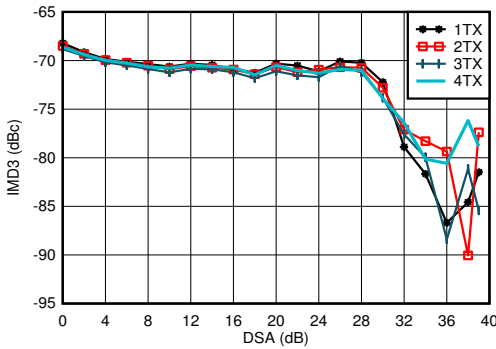

$f_{DAC} = 11796.48\text{MSPS}$, interleaved mode, matching at 4.9GHz, $f_{CENTER} = 4.9\text{GHz}$, -13dBFS each tone

4-169. TX IMD3 vs DSA Setting at 4.9GHz

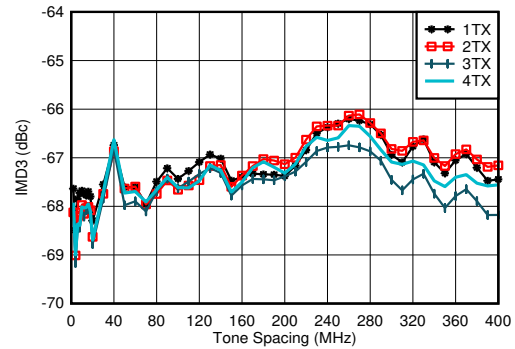

$f_{DAC} = 11796.48\text{MSPS}$, interleaved mode, matching at 4.9GHz, $f_{CENTER} = 4.9\text{GHz}$, -13dBFS each tone

4-170. TX IMD3 vs Tone Spacing and Channel at 4.9GHz

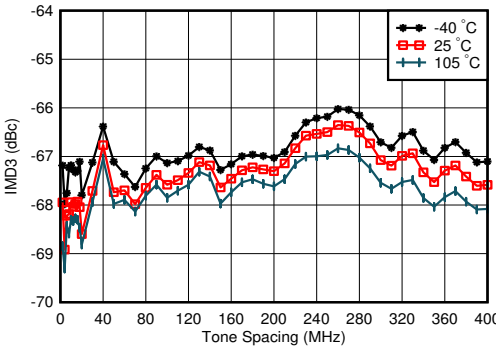

$f_{DAC} = 11796.48\text{MSPS}$, interleaved mode, matching at 4.9GHz, $f_{CENTER} = 4.9\text{GHz}$, -13dBFS each tone, worst channel

4-171. TX IMD3 vs Tone Spacing and Temperature at 4.9GHz

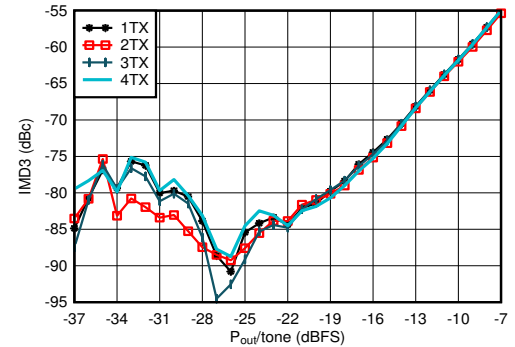

$f_{DAC} = 11796.48\text{MSPS}$, interleaved mode, matching at 4.9GHz, $f_{CENTER} = 4.9\text{GHz}$, $f_{SPACING} = 20\text{MHz}$

4-172. TX IMD3 vs Digital Level at 4.9GHz

4.12.5 TX Typical Characteristics at 4.9GHz (continued)

Typical values at $T_A = +25^\circ\text{C}$ with nominal supplies. Default conditions: TX input data rate = 491.52MSPS, $f_{DAC} = 11796.48\text{MSPS}$ (24x interpolation), interleave mode, 1st Nyquist zone output, PLL clock mode with $f_{REF} = 491.52\text{MHz}$, $A_{OUT} = -1\text{dBFS}$, DSA = 0dB, Sin(x)/x enabled, DSA calibrated

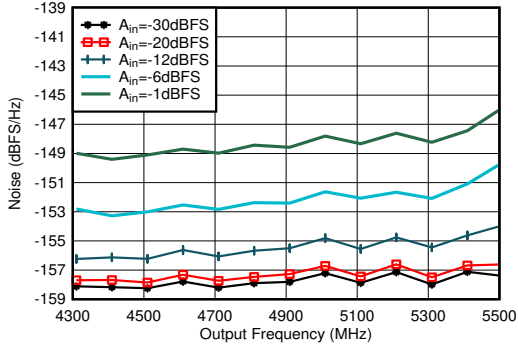

Matching at 4.9GHz, Single tone, $f_{DAC} = 11.79648\text{GSPS}$, interleave mode, 40MHz offset, DSA = 0dB

4-173. TX Single Tone Output Noise vs Frequency and Amplitude at 4.9GHz

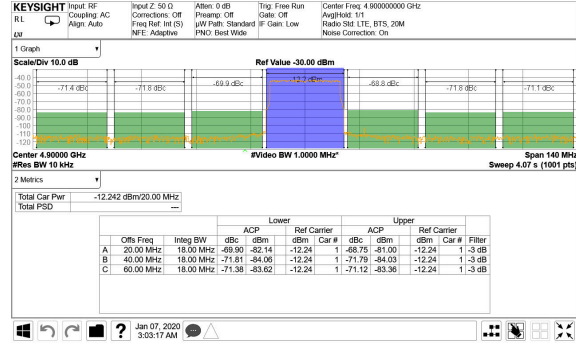

TM1.1, $P_{OUT_RMS} = -13\text{dBFS}$

4-174. TX 20MHz LTE Output Spectrum at 4.9GHz

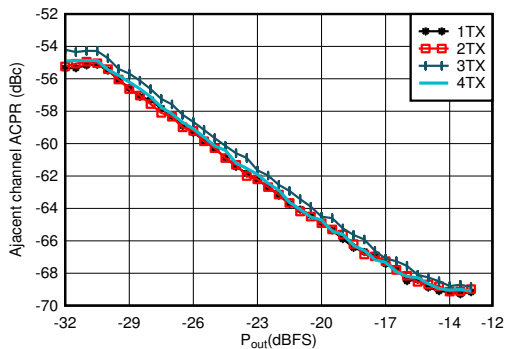

Matching at 4.9GHz, single carrier 20MHz BW TM1.1 LTE

4-175. TX 20MHz LTE ACPR vs Digital Level at 4.9GHz

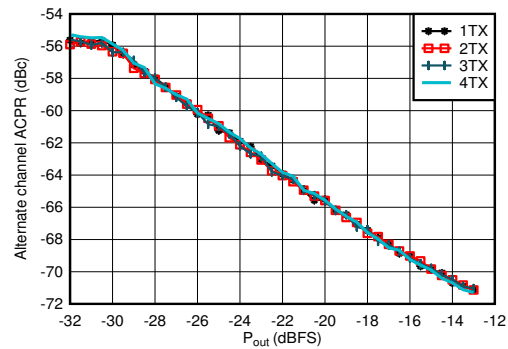

Matching at 4.9GHz, single carrier 20MHz BW TM1.1 LTE

4-176. TX 20MHz LTE alt-ACPR vs Digital Level at 4.9GHz

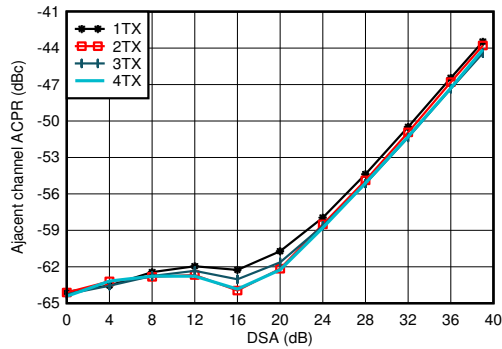

Matching at 4.9GHz, single carrier 20MHz BW TM1.1 LTE

4-177. TX 20MHz LTE ACPR vs DSA at 4.9GHz

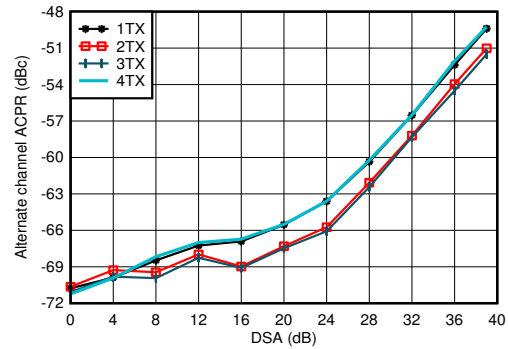

Matching at 4.9GHz, single carrier 20MHz BW TM1.1 LTE

4-178. TX 20MHz LTE alt-ACPR vs DSA at 4.9GHz

4.12.5 TX Typical Characteristics at 4.9GHz (continued)

Typical values at $T_A = +25^\circ\text{C}$ with nominal supplies. Default conditions: TX input data rate = 491.52MSPS, $f_{DAC} = 11796.48\text{MSPS}$ (24x interpolation), interleave mode, 1st Nyquist zone output, PLL clock mode with $f_{REF} = 491.52\text{MHz}$, $A_{OUT} = -1\text{dBFS}$, DSA = 0dB, Sin(x)/x enabled, DSA calibrated

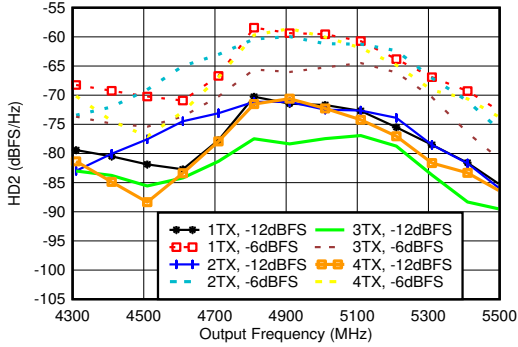

Matching at 4.9GHz, $f_{DAC} = 11.79648\text{GSPS}$, interleave mode, normalized to output power at harmonic frequency

图 4-179. TX HD2 vs Digital Amplitude and Output Frequency at 4.9GHz

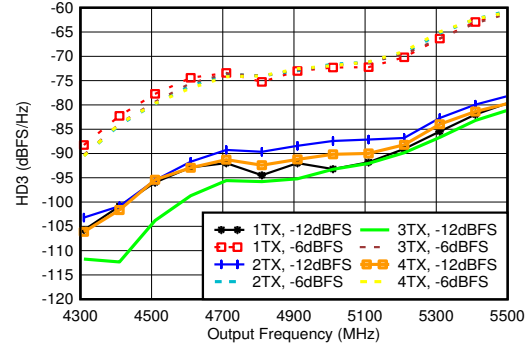

Matching at 4.9GHz, $f_{DAC} = 11.79648\text{GSPS}$, interleave mode, normalized to output power at harmonic frequency

图 4-180. TX HD3 vs Digital Amplitude and Output Frequency at 4.9GHz

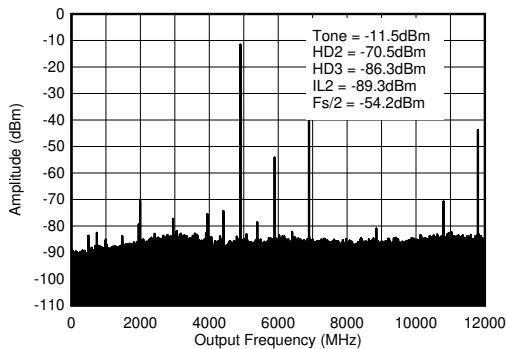

$f_{DAC} = 11796.48\text{MSPS}$, interleave mode, 4.9GHz matching, includes PCB and cable losses. $IL_n = f_s/n \pm f_{OUT}$.

图 4-181. TX Single Tone (-12 dBFS) Output Spectrum at 4.9GHz (0- f_{DAC})

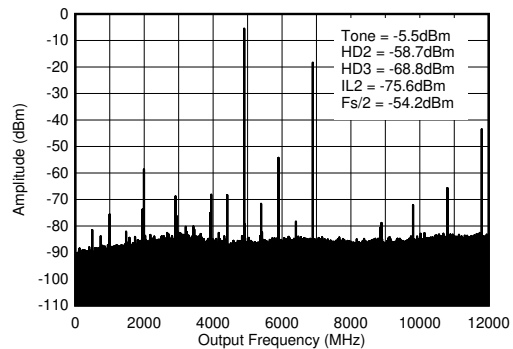

$f_{DAC} = 11796.48\text{MSPS}$, interleave mode, 4.9GHz matching, includes PCB and cable losses. $IL_n = f_s/n \pm f_{OUT}$.

图 4-182. TX Single Tone (-6 dBFS) Output Spectrum at 4.9GHz (0- f_{DAC})

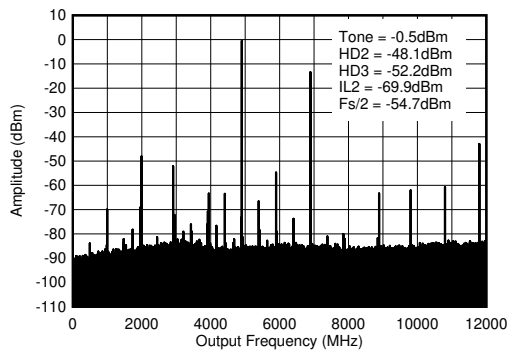

$f_{DAC} = 11796.48\text{MSPS}$, interleave mode, 4.9GHz matching, includes PCB and cable losses. $IL_n = f_s/n \pm f_{OUT}$.

图 4-183. TX Single Tone (-1 dBFS) Output Spectrum at 4.9GHz (0- f_{DAC})

4.12.6 TX Typical Characteristics at 8.1GHz

Typical values at $T_A = +25^\circ\text{C}$ with nominal supplies. Default conditions: TX input data rate = 491.52MSPS, $f_{\text{DAC}} = 11796.48$ MSPS (24x interpolation), mixed mode, 1st Nyquist zone output, PLL clock mode with $f_{\text{REF}} = 491.52\text{MHz}$, $A_{\text{OUT}} = -1$ dBFS, DSA = 0 dB, Sin(x)/x enabled, DSA calibrated, 8.1GHz matching

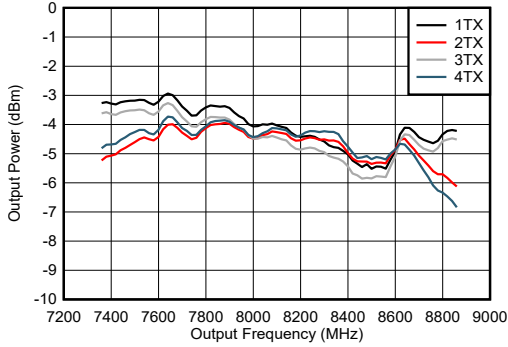

includes PCB and cable losses.

4-184. TX Output Power vs Frequency at 8.11GHz

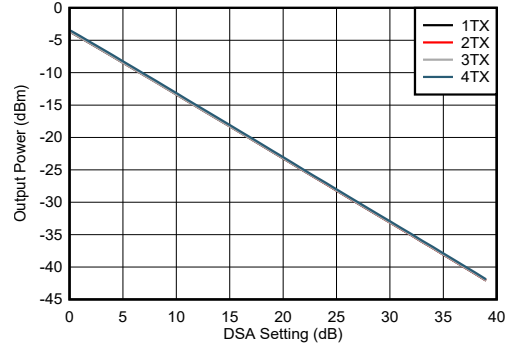

includes PCB and cable losses.

4-185. TX Output Power vs DSA Setting at 8.11GHz

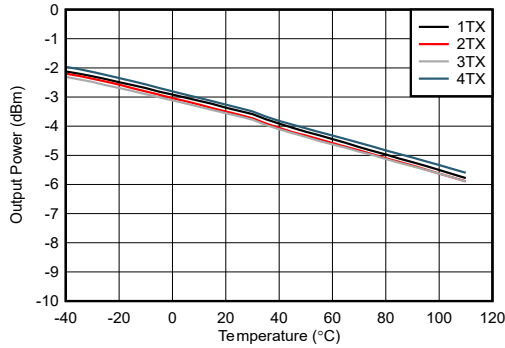

includes PCB and cable losses.

4-186. TX Output Power vs Temperature at 8.11GHz

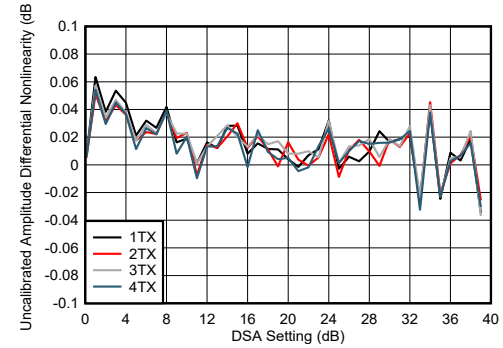

4-187. TX DSA Uncalibrated Amplitude Differential Nonlinearity at 8.11GHz

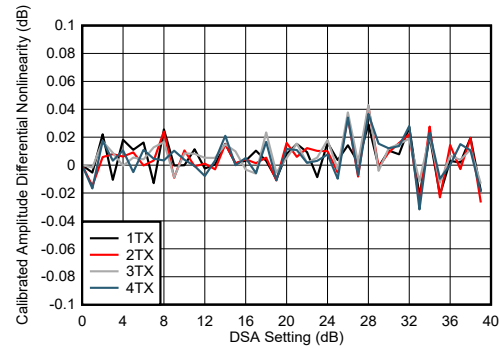

4-188. TX DSA Calibrated Amplitude Differential Nonlinearity at 8.11GHz

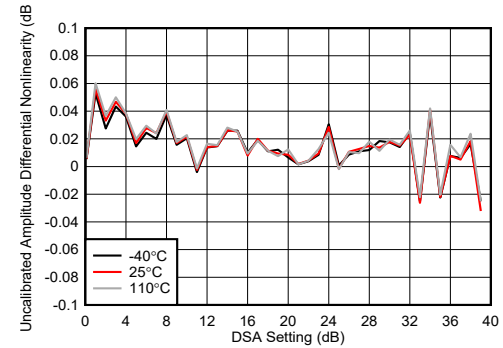

4-189. TX DSA Uncalibrated Amplitude Differential Nonlinearity at 8.11GHz

4.12.6 TX Typical Characteristics at 8.1GHz (continued)

Typical values at $T_A = +25^\circ\text{C}$ with nominal supplies. Default conditions: TX input data rate = 491.52MSPS, $f_{\text{DAC}} = 11796.48$ MSPS (24x interpolation), mixed mode, 1st Nyquist zone output, PLL clock mode with $f_{\text{REF}} = 491.52\text{MHz}$, $A_{\text{OUT}} = -1$ dBFS, DSA = 0 dB, Sin(x)/x enabled, DSA calibrated, 8.1GHz matching

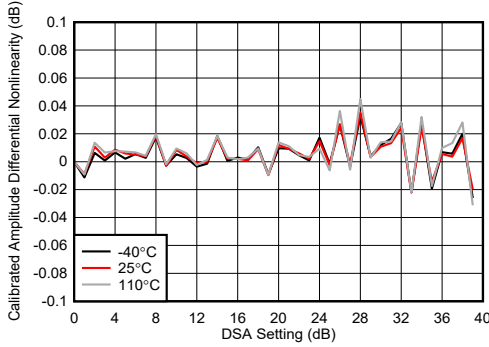

4-190. TX DSA Calibrated Amplitude Differential Nonlinearity at 8.11GHz

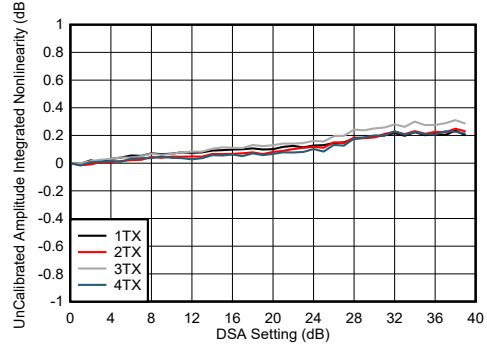

4-191. TX DSA Uncalibrated Amplitude Integrated Nonlinearity at 8.11GHz

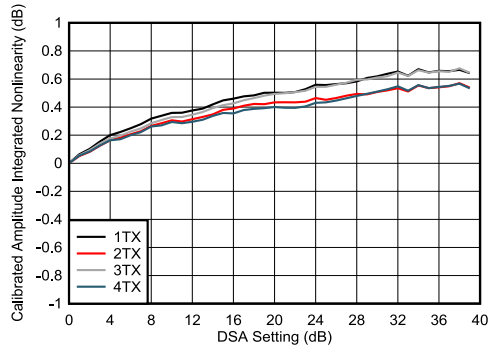

4-192. TX DSA Calibrated Amplitude Integrated Nonlinearity at 8.11GHz

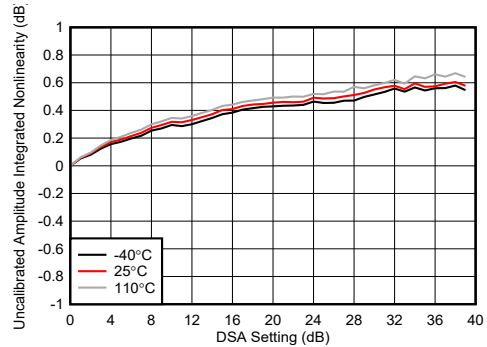

4-193. TX DSA Uncalibrated Amplitude Integrated Nonlinearity at 8.11GHz

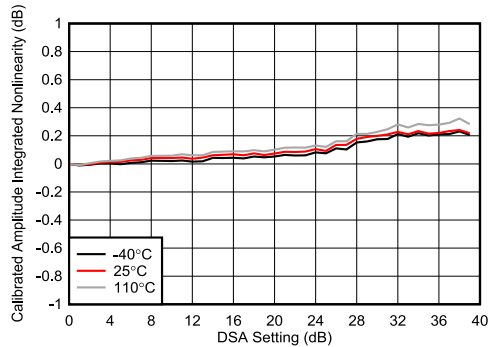

4-194. TX DSA Calibrated Amplitude Integrated Nonlinearity at 8.11GHz

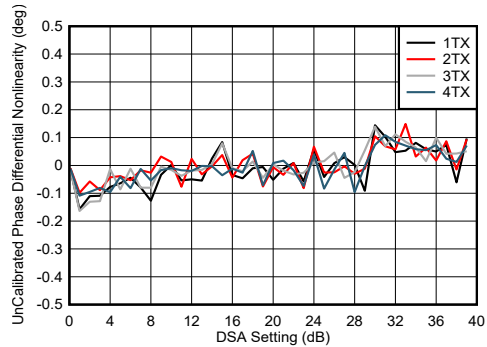

4-195. TX DSA Uncalibrated Phase Differential Nonlinearity at 8.11GHz

4.12.6 TX Typical Characteristics at 8.1GHz (continued)

Typical values at $T_A = +25^\circ\text{C}$ with nominal supplies. Default conditions: TX input data rate = 491.52MSPS, $f_{\text{DAC}} = 11796.48$ MSPS (24x interpolation), mixed mode, 1st Nyquist zone output, PLL clock mode with $f_{\text{REF}} = 491.52\text{MHz}$, $A_{\text{OUT}} = -1$ dBFS, DSA = 0 dB, Sin(x)/x enabled, DSA calibrated, 8.1GHz matching

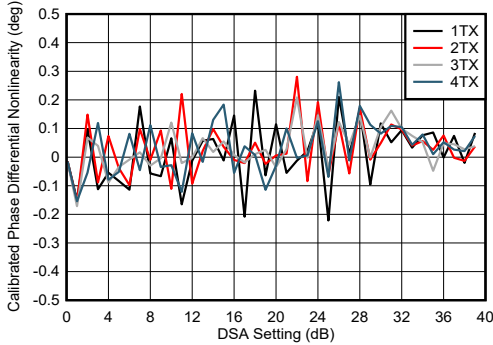

4-196. TX DSA Calibrated Phase Differential Nonlinearity at 8.1GHz

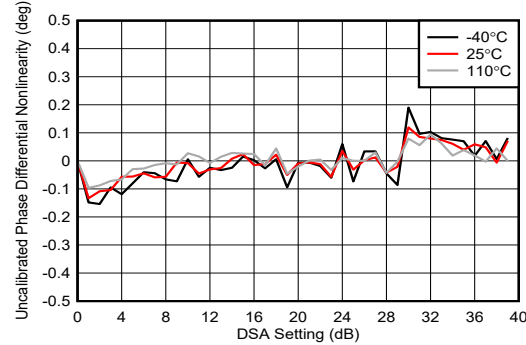

4-197. TX DSA Uncalibrated Phase Differential Nonlinearity at 8.1GHz

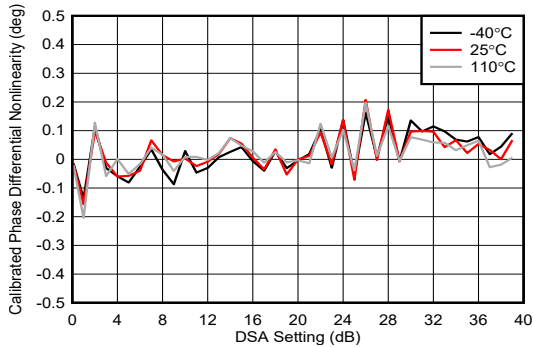

4-198. TX DSA Calibrated Phase Differential Nonlinearity at 8.1GHz

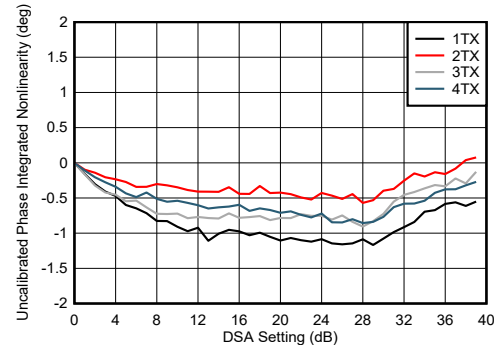

4-199. TX DSA Uncalibrated Phase Integrated Nonlinearity at 8.1GHz

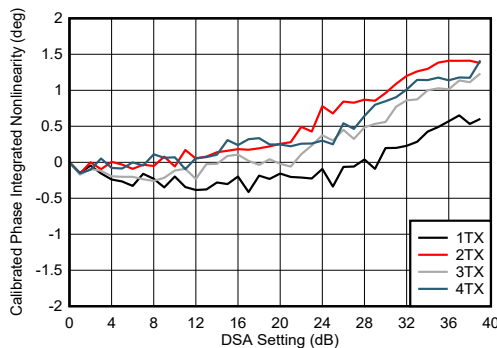

4-200. TX DSA Calibrated Phase Integrated Nonlinearity at 8.1GHz

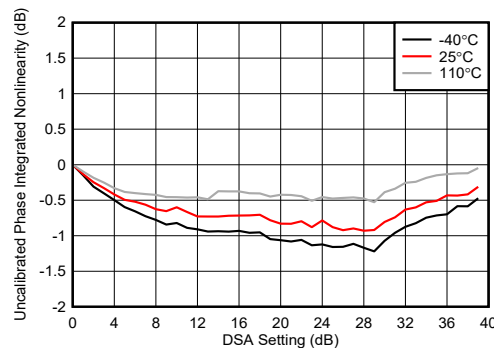

4-201. TX DSA Uncalibrated Phase Integrated Nonlinearity at 8.1GHz

4.12.6 TX Typical Characteristics at 8.1GHz (continued)

Typical values at $T_A = +25^\circ\text{C}$ with nominal supplies. Default conditions: TX input data rate = 491.52MSPS, $f_{\text{DAC}} = 11796.48$ MSPS (24x interpolation), mixed mode, 1st Nyquist zone output, PLL clock mode with $f_{\text{REF}} = 491.52\text{MHz}$, $A_{\text{OUT}} = -1$ dBFS, DSA = 0 dB, Sin(x)/x enabled, DSA calibrated, 8.1GHz matching

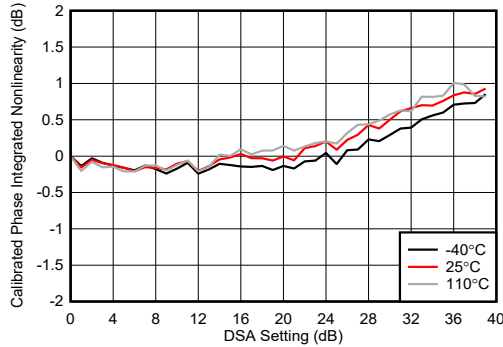

4-202. TX DSA Calibrated Phase Integrated Nonlinearity at 8.1GHz

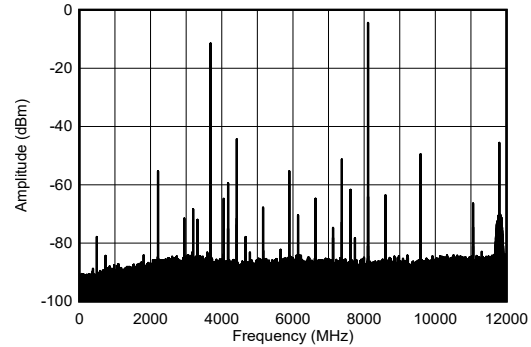

-1dBFS
4-203. TX Single Tone Output Spectrum at 8.1GHz

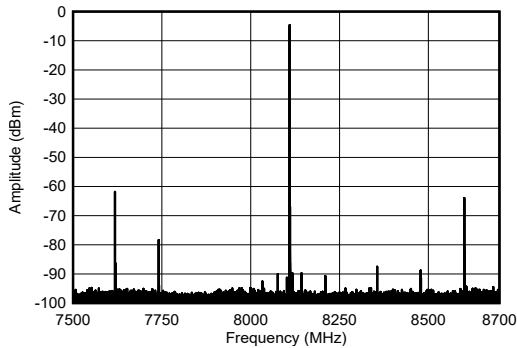

-1dBFS
4-204. TX Single Tone Output Spectrum at 8.1GHz

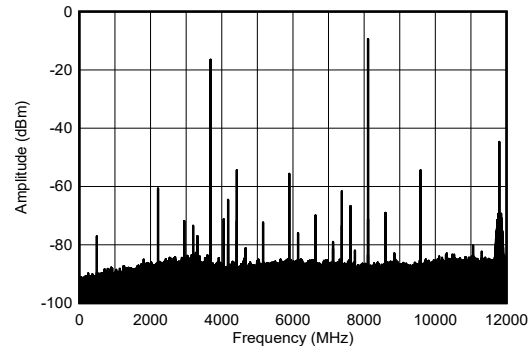

-6dBFS
4-205. TX Single Tone Output Spectrum at 8.1GHz

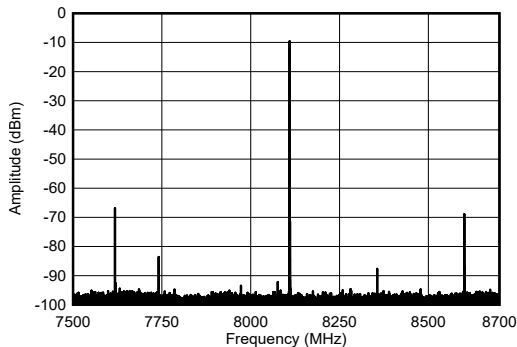

-6dBFS
4-206. TX Single Tone Output Spectrum at 8.1GHz

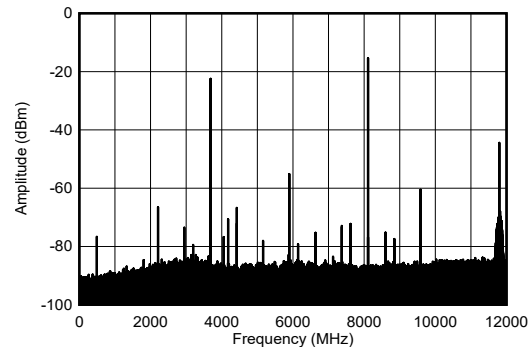

-12dBFS
4-207. TX Single Tone Output Spectrum at 8.1GHz

4.12.6 TX Typical Characteristics at 8.1GHz (continued)

Typical values at $T_A = +25^\circ\text{C}$ with nominal supplies. Default conditions: TX input data rate = 491.52MSPS, $f_{DAC} = 11796.48$ MSPS (24x interpolation), mixed mode, 1st Nyquist zone output, PLL clock mode with $f_{REF} = 491.52\text{MHz}$, $A_{OUT} = -1$ dBFS, DSA = 0 dB, Sin(x)/x enabled, DSA calibrated, 8.1GHz matching

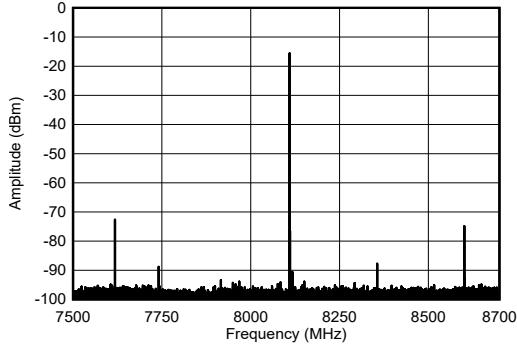

-12dBFS

4-208. TX Single Tone Output Spectrum at 8.11GHz

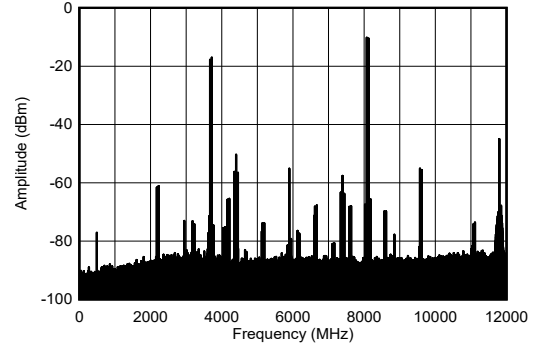

50MHz tone spacing, -7dBFS each tone

4-209. TX Dual Tone Output Spectrum at 8.11GHz

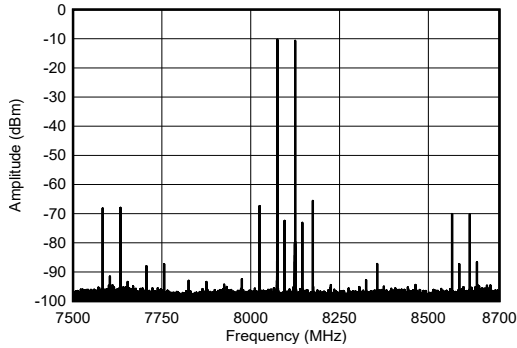

50MHz tone spacing, -7dBFS each tone

4-210. TX Dual Tone Output Spectrum at 8.11GHz

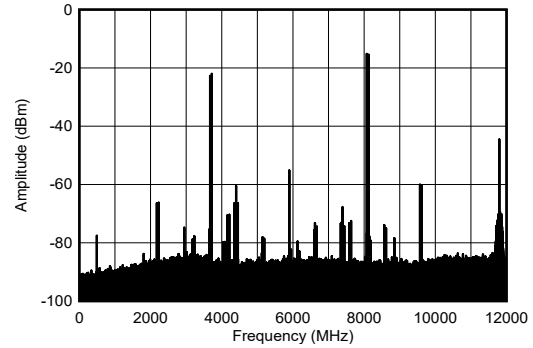

50MHz tone spacing, -12dBFS each tone

4-211. TX Dual Tone Output Spectrum at 8.11GHz

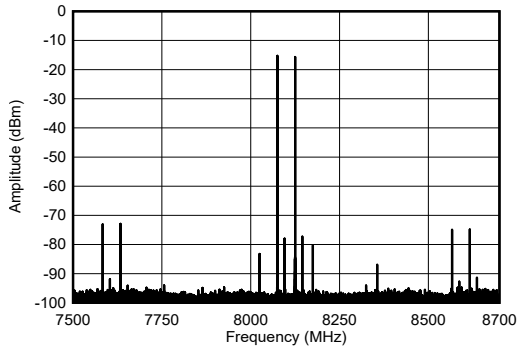

50MHz tone spacing, -12dBFS each tone

4-212. TX Dual Tone Output Spectrum at 8.11GHz

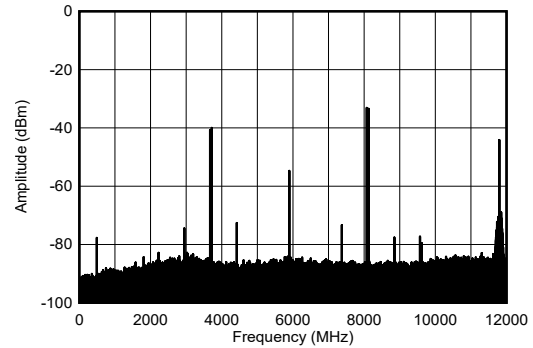

50MHz tone spacing, -30dBFS each tone

4-213. TX Dual Tone Output Spectrum at 8.11GHz

4.12.6 TX Typical Characteristics at 8.1GHz (continued)

Typical values at $T_A = +25^\circ\text{C}$ with nominal supplies. Default conditions: TX input data rate = 491.52MSPS, $f_{\text{DAC}} = 11796.48$ MSPS (24x interpolation), mixed mode, 1st Nyquist zone output, PLL clock mode with $f_{\text{REF}} = 491.52\text{MHz}$, $A_{\text{OUT}} = -1$ dBFS, DSA = 0 dB, Sin(x)/x enabled, DSA calibrated, 8.1GHz matching

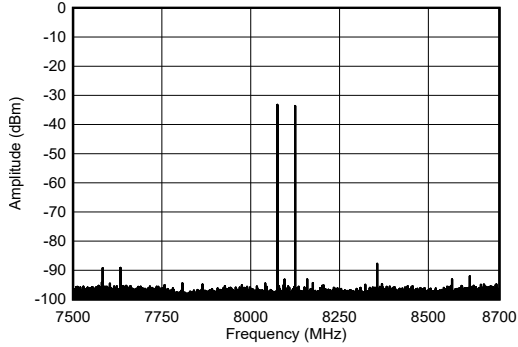

50MHz tone spacing, -30dBFS each tone

Figure 4-214. TX Dual Tone Output Spectrum at 8.11GHz

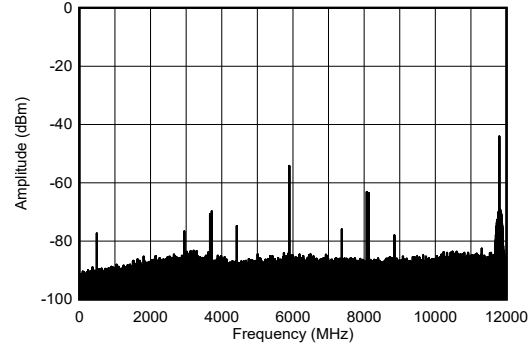

50MHz tone spacing, -60dBFS each tone

Figure 4-215. TX Dual Tone Output Spectrum at 8.11GHz

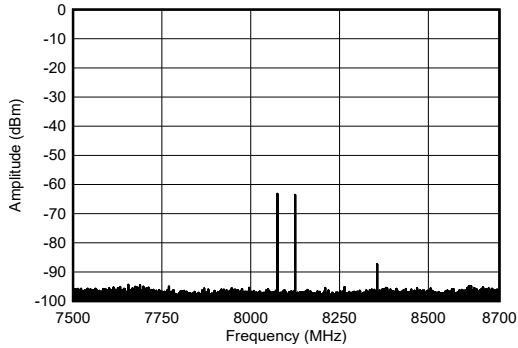

50MHz tone spacing, -60dBFS each tone

Figure 4-216. TX Dual Tone Output Spectrum at 8.11GHz

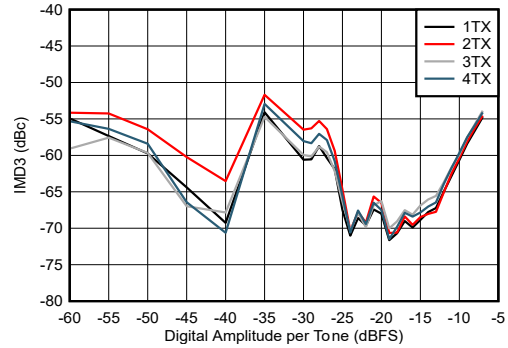

-7dBFS each tone, 50MHz tone spacing

Figure 4-217. TX IMD3 vs Digital Amplitude at 8.11GHz

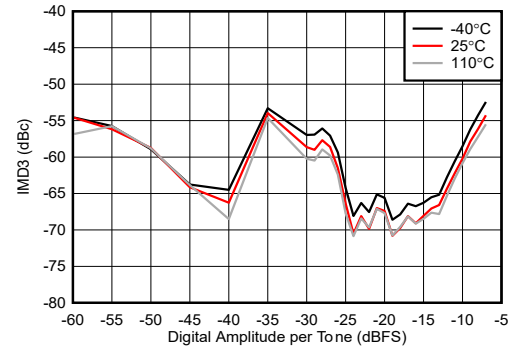

-7dBFS each tone, 50MHz tone spacing

Figure 4-218. TX IMD3 vs Digital Amplitude at 8.11GHz

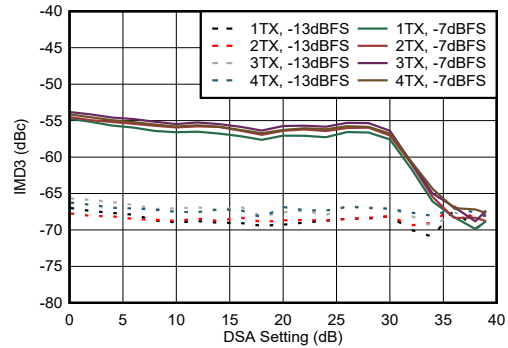

50MHz tone spacing

Figure 4-219. TX IMD3 vs DSA Setting at 8.11GHz

4.12.6 TX Typical Characteristics at 8.1GHz (continued)

Typical values at $T_A = +25^\circ\text{C}$ with nominal supplies. Default conditions: TX input data rate = 491.52MSPS, $f_{\text{DAC}} = 11796.48$ MSPS (24x interpolation), mixed mode, 1st Nyquist zone output, PLL clock mode with $f_{\text{REF}} = 491.52\text{MHz}$, $A_{\text{OUT}} = -1$ dBFS, DSA = 0 dB, Sin(x)/x enabled, DSA calibrated, 8.1GHz matching

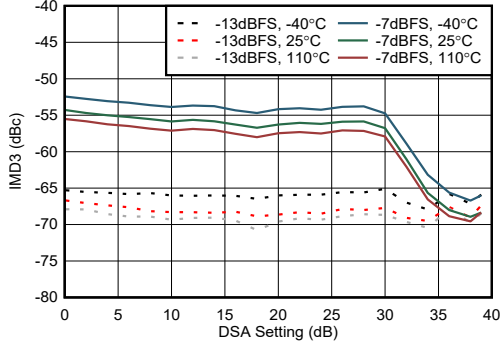

50 MHz tone spacing

4-220. TX IMD3 vs DSA Setting at 8.11GHz

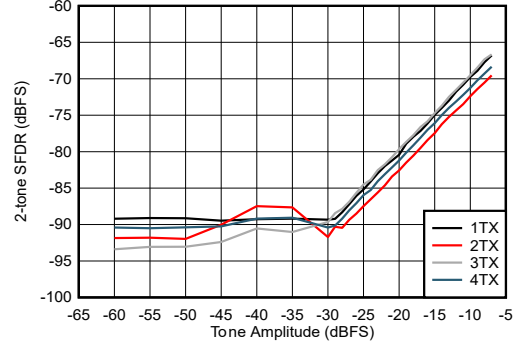

50 MHz tone spacing

4-221. TX 2-Tone SFDR vs Digital Amplitude at 8.11GHz

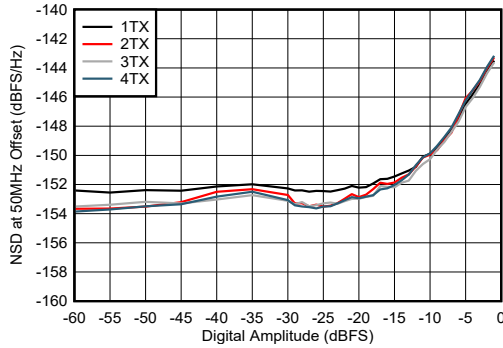

50 MHz offset

4-222. TX NSD vs Digital Amplitude at 8.11GHz

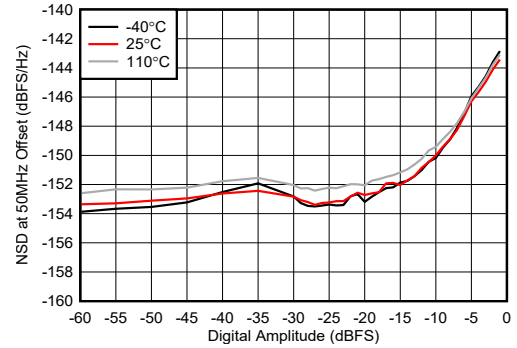

50 MHz offset

4-223. TX NSD vs Digital Amplitude at 8.11GHz

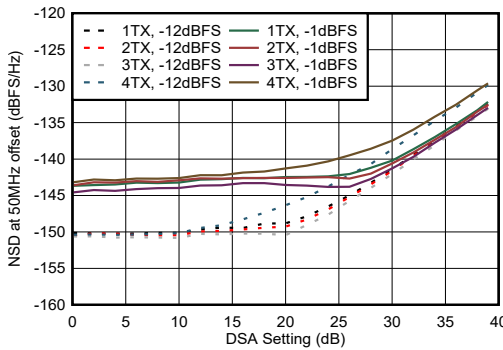

50 MHz offset

4-224. TX NSD vs DSA Setting at 8.11GHz

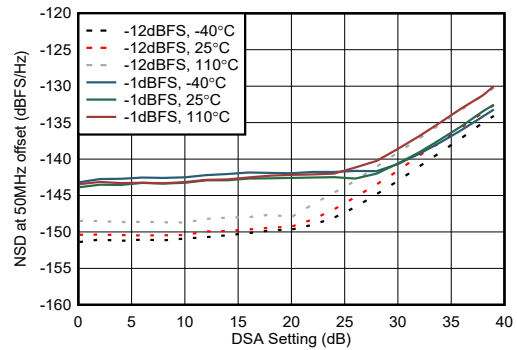

50 MHz offset

4-225. TX NSD vs DSA Setting at 8.11GHz

4.12.6 TX Typical Characteristics at 8.1GHz (continued)

Typical values at $T_A = +25^\circ\text{C}$ with nominal supplies. Default conditions: TX input data rate = 491.52MSPS, $f_{\text{DAC}} = 11796.48$ MSPS (24x interpolation), mixed mode, 1st Nyquist zone output, PLL clock mode with $f_{\text{REF}} = 491.52\text{MHz}$, $A_{\text{OUT}} = -1$ dBFS, DSA = 0 dB, Sin(x)/x enabled, DSA calibrated, 8.1GHz matching

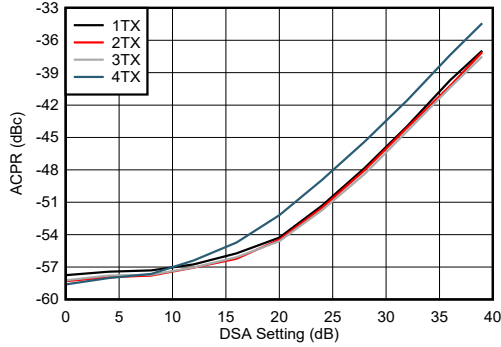

4-226. TX NR100MHz ACPR vs DSA Setting 8.11GHz

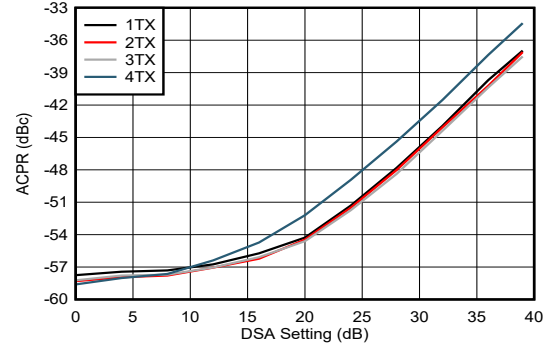

4-227. TX NR100MHz alt-ACPR vs DSA Setting 8.11GHz

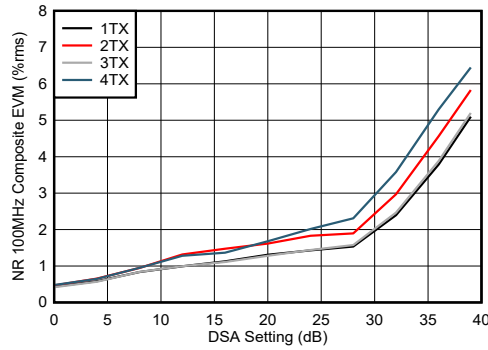

4-228. TX NR100MHz EVM vs DSA Setting 8.11GHz

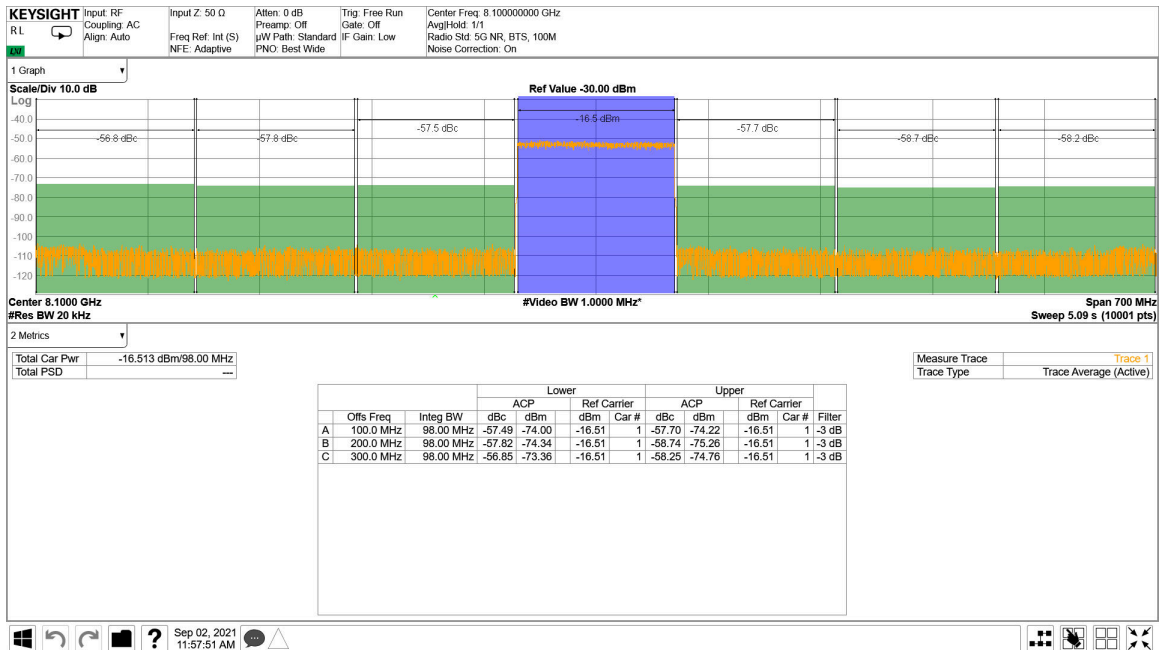

4-229. TX 100MHz NR Output Spectrum at 8.11GHz

4.12.6 TX Typical Characteristics at 8.1GHz (continued)

Typical values at $T_A = +25^\circ\text{C}$ with nominal supplies. Default conditions: TX input data rate = 491.52MSPS, $f_{DAC} = 11796.48$ MSPS (24x interpolation), mixed mode, 1st Nyquist zone output, PLL clock mode with $f_{REF} = 491.52\text{MHz}$, $A_{OUT} = -1$ dBFS, DSA = 0 dB, Sin(x)/x enabled, DSA calibrated, 8.1GHz matching

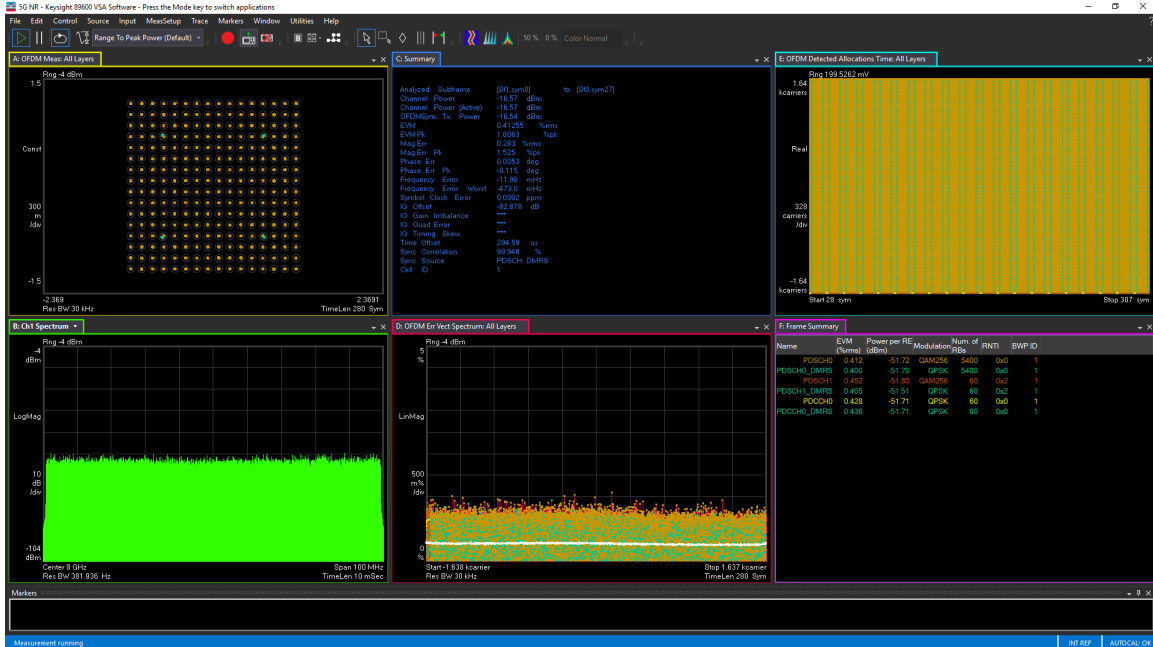

4-230. TX 100MHz NR EVM at 8.1GHz

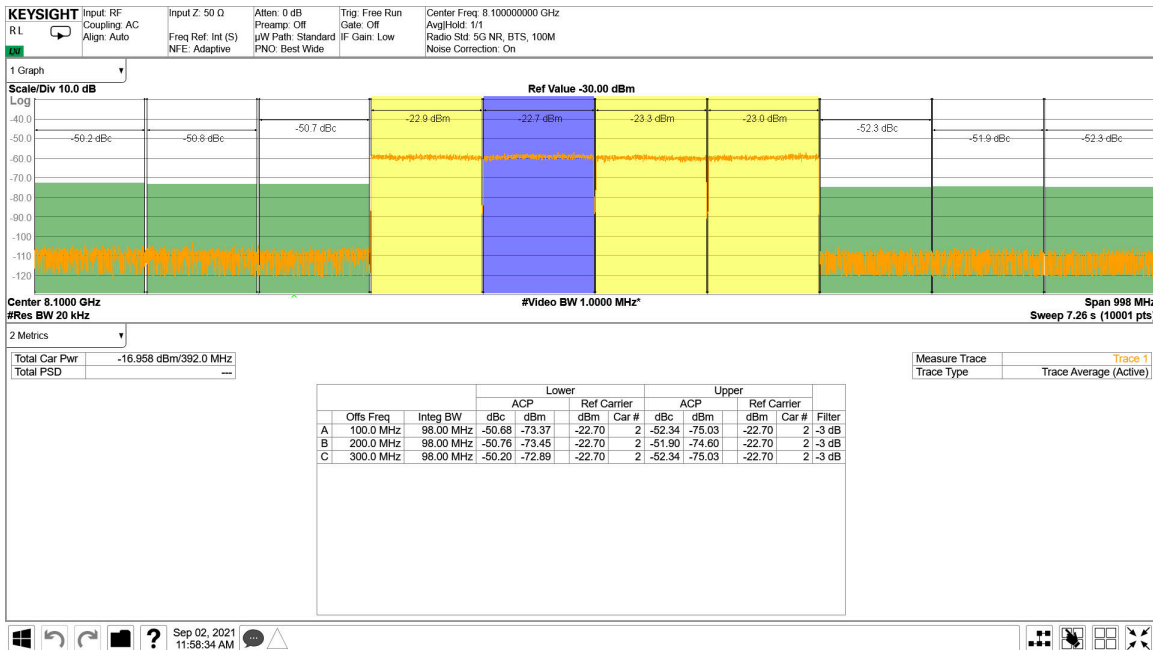

4-231. TX 4x100MHz NR Output Spectrum 8.1GHz

4.12.6 TX Typical Characteristics at 8.1GHz (continued)

Typical values at $T_A = +25^\circ\text{C}$ with nominal supplies. Default conditions: TX input data rate = 491.52MSPS, $f_{\text{DAC}} = 11796.48$ MSPS (24x interpolation), mixed mode, 1st Nyquist zone output, PLL clock mode with $f_{\text{REF}} = 491.52\text{MHz}$, $A_{\text{OUT}} = -1$ dBFS, DSA = 0 dB, Sin(x)/x enabled, DSA calibrated, 8.1GHz matching

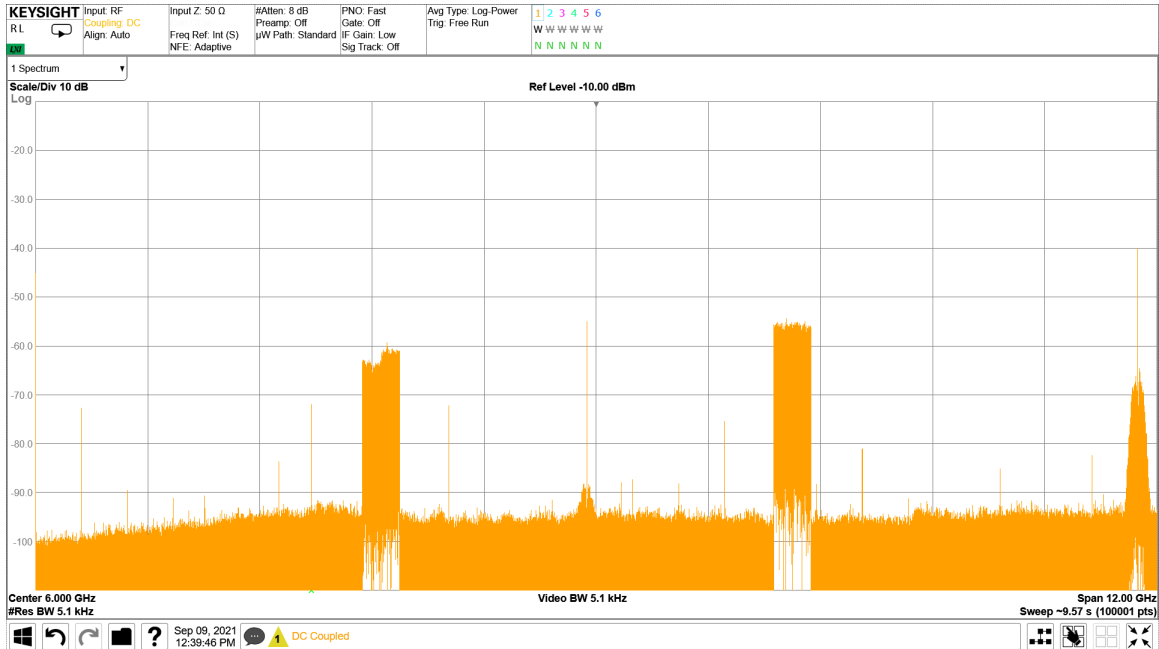

4-232. TX 4x100MHz NR Output Spectrum 8.11GHz

4.12.7 TX Typical Characteristics at 9.6GHz

Typical values at $T_A = +25^\circ\text{C}$ with nominal supplies. Default conditions: TX input data rate = 1474.56MSPS, $f_{\text{DAC}} = 11796.48\text{MSPS}$ (8x interpolation), Mixed mode, 1st Nyquist zone output, PLL clock mode with $f_{\text{REF}} = 491.52\text{MHz}$, $A_{\text{OUT}} = -1\text{dBFS}$, DSA = 0dB, Sin(x)/x enabled, DSA calibrated, 9.6GHz matching

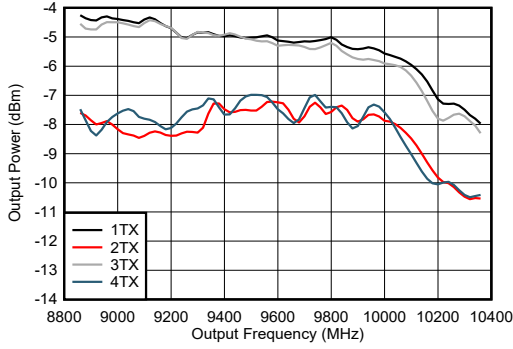

Includes PCB and cable losses.

4-233. TX Output Power vs Frequency at 9.61GHz

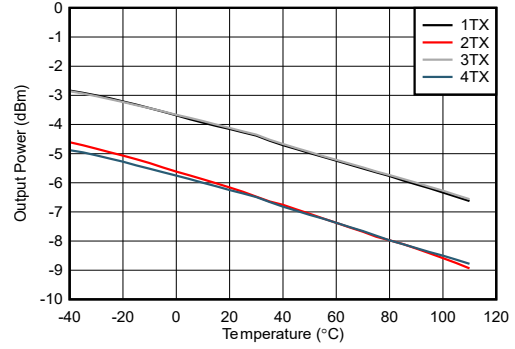

Includes PCB and cable losses.

4-234. TX Output Power vs Frequency at 9.61GHz

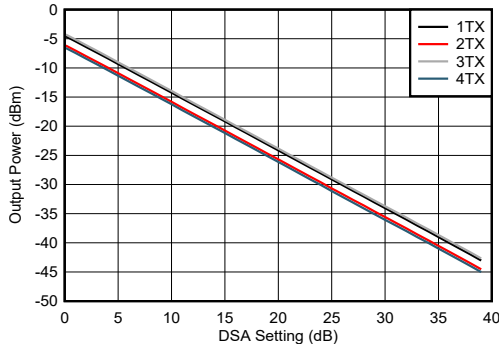

Includes PCB and cable losses.

4-235. TX Output Power vs DSA Setting at 9.61GHz

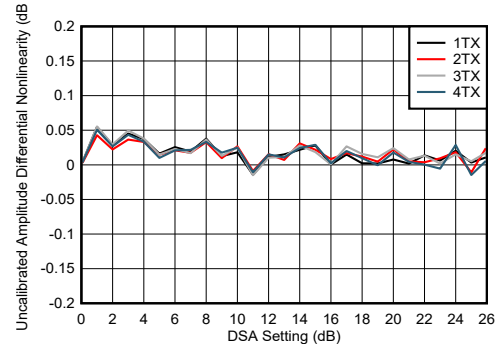

4-236. TX DSA Uncalibrated Amplitude Differential Nonlinearity

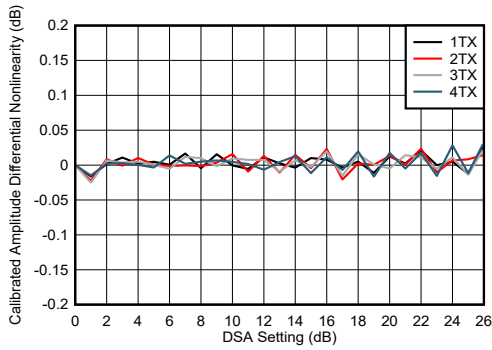

4-237. TX DSA Calibrated Amplitude Differential Nonlinearity

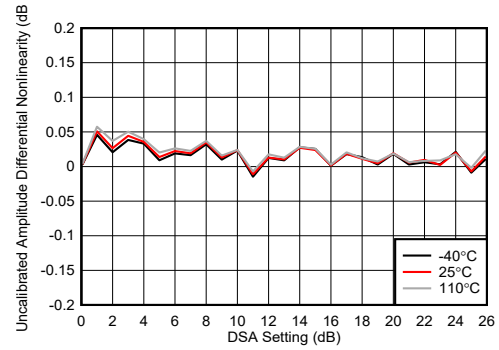

4-238. TX DSA Uncalibrated Amplitude Differential Nonlinearity

4.12.7 TX Typical Characteristics at 9.6GHz (continued)

Typical values at $T_A = +25^\circ\text{C}$ with nominal supplies. Default conditions: TX input data rate = 1474.56MSPS, $f_{DAC} = 11796.48\text{MSPS}$ (8x interpolation), Mixed mode, 1st Nyquist zone output, PLL clock mode with $f_{REF} = 491.52\text{MHz}$, $A_{OUT} = -1\text{dBFS}$, DSA = 0dB, Sin(x)/x enabled, DSA calibrated, 9.6GHz matching

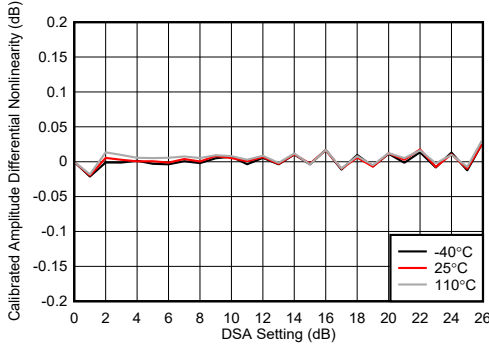

4-239. TX DSA Calibrated Amplitude Differential Nonlinearity

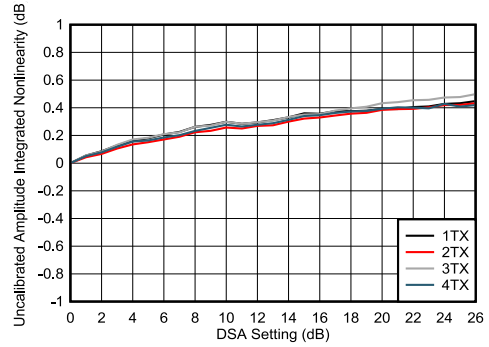

4-240. TX DSA Uncalibrated Amplitude Integrated Nonlinearity

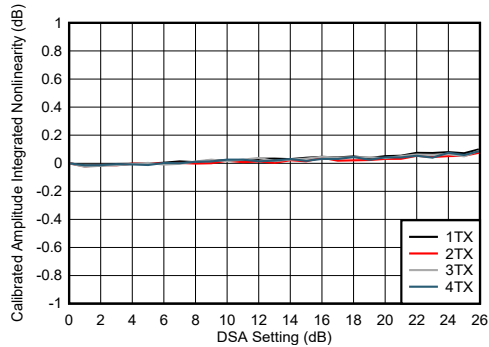

4-241. TX DSA Calibrated Amplitude Integrated Nonlinearity

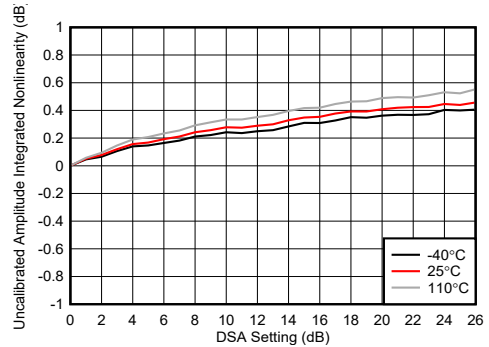

4-242. TX DSA Uncalibrated Amplitude Integrated Nonlinearity

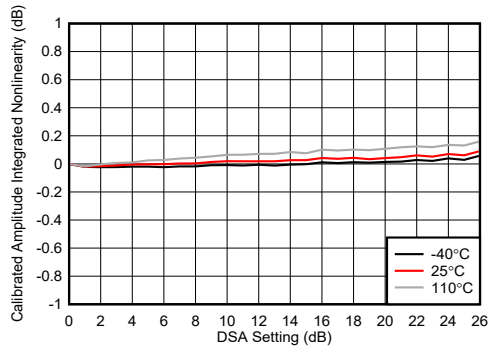

4-243. TX DSA Calibrated Amplitude Integrated Nonlinearity

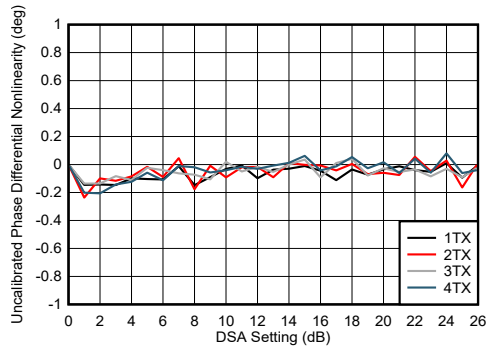

4-244. TX DSA Uncalibrated Phase Differential Nonlinearity

4.12.7 TX Typical Characteristics at 9.6GHz (continued)

Typical values at $T_A = +25^\circ\text{C}$ with nominal supplies. Default conditions: TX input data rate = 1474.56MSPS, $f_{\text{DAC}} = 11796.48\text{MSPS}$ (8x interpolation), Mixed mode, 1st Nyquist zone output, PLL clock mode with $f_{\text{REF}} = 491.52\text{MHz}$, $A_{\text{OUT}} = -1\text{dBFS}$, DSA = 0dB, Sin(x)/x enabled, DSA calibrated, 9.6GHz matching

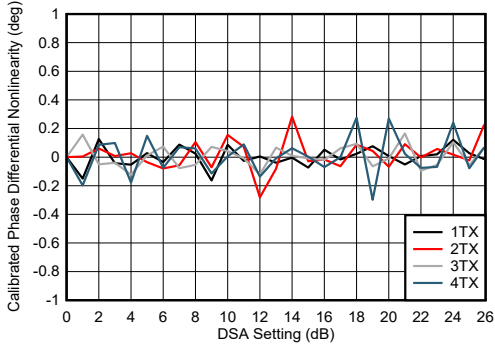

4-245. TX DSA Calibrated Phase Differential Nonlinearity

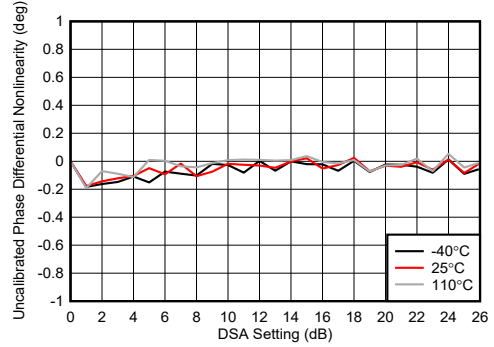

4-246. TX DSA Uncalibrated Phase Differential Nonlinearity

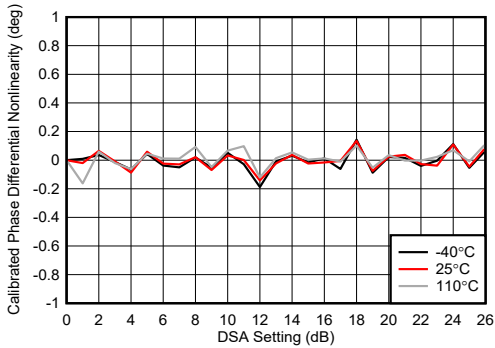

4-247. TX DSA Calibrated DSA Phase Differential Nonlinearity

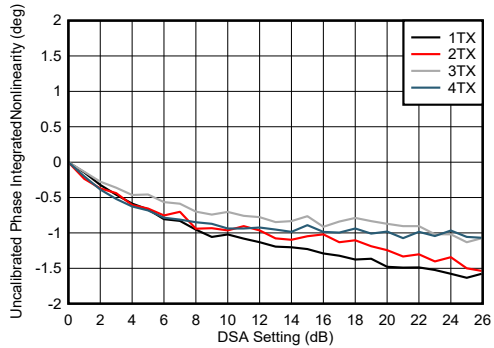

4-248. TX DSA Uncalibrated Phase Integrated Nonlinearity

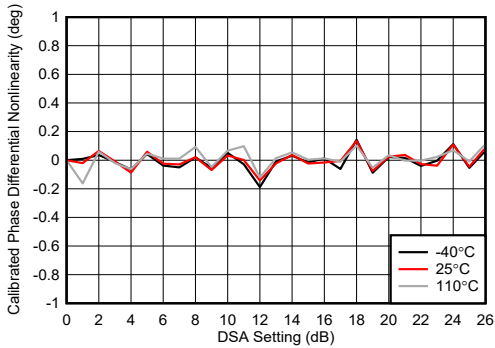

4-249. TX DSA Calibrated Phase Integrated Nonlinearity

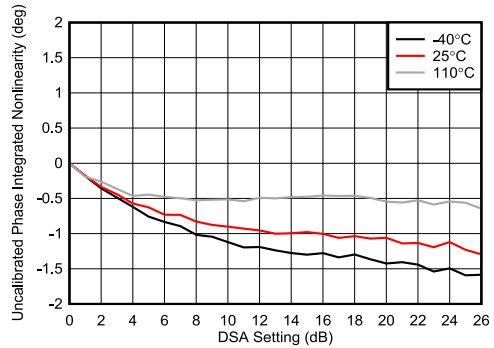

4-250. TX DSA Uncalibrated Phase Integrated Nonlinearity

4.12.7 TX Typical Characteristics at 9.6GHz (continued)

Typical values at $T_A = +25^\circ\text{C}$ with nominal supplies. Default conditions: TX input data rate = 1474.56MSPS, $f_{DAC} = 11796.48\text{MSPS}$ (8x interpolation), Mixed mode, 1st Nyquist zone output, PLL clock mode with $f_{REF} = 491.52\text{MHz}$, $A_{OUT} = -1\text{dBFS}$, DSA = 0dB, Sin(x)/x enabled, DSA calibrated, 9.6GHz matching

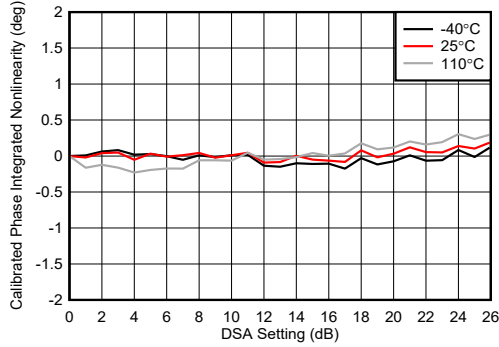

4-251. TX DSA Calibrated Amplitude Integrated Nonlinearity

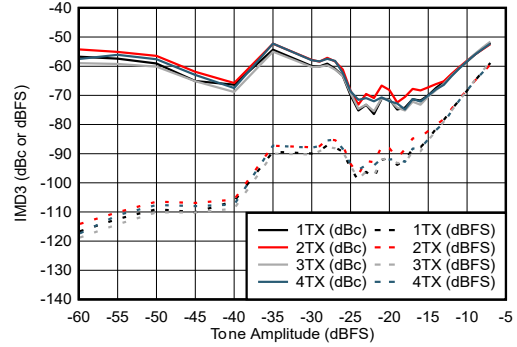

50MHz tone spacing
4-252. TX IMD3 vs Digital Amplitude at 9.61GHz

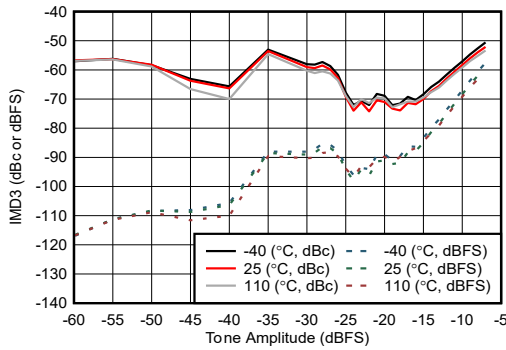

50MHz tone spacing
4-253. TX IMD3 vs Digital Amplitude at 9.61GHz

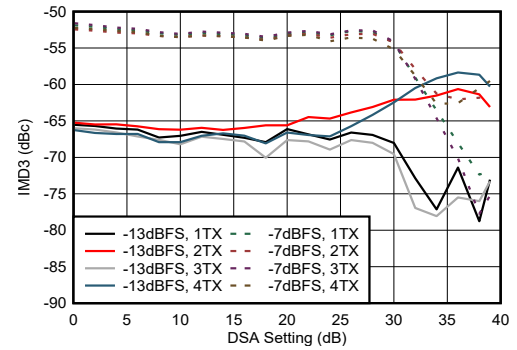

50MHz tone spacing
4-254. TX IMD3 vs DSA Setting at 9.61GHz

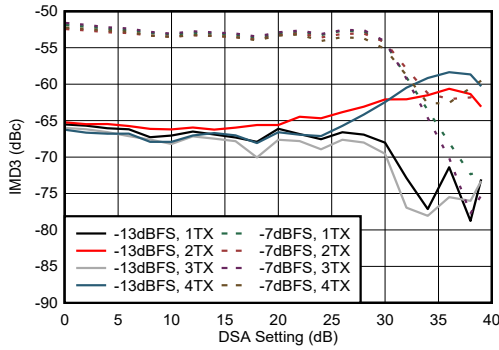

50MHz tone spacing
4-255. TX IMD3 vs DSA Setting at 9.61GHz

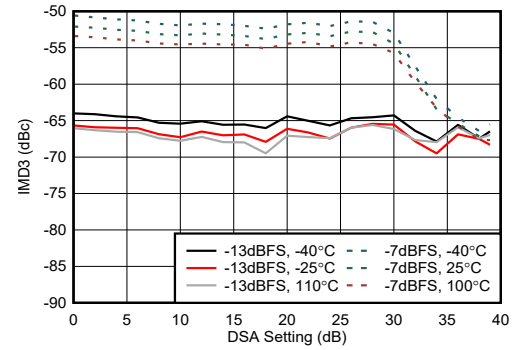

50MHz tone spacing
4-256. TX IMD3 vs DSA Setting at 9.61GHz

4.12.7 TX Typical Characteristics at 9.6GHz (continued)

Typical values at $T_A = +25^\circ\text{C}$ with nominal supplies. Default conditions: TX input data rate = 1474.56MSPS, $f_{\text{DAC}} = 11796.48\text{MSPS}$ (8x interpolation), Mixed mode, 1st Nyquist zone output, PLL clock mode with $f_{\text{REF}} = 491.52\text{MHz}$, $A_{\text{OUT}} = -1\text{dBFS}$, DSA = 0dB, Sin(x)/x enabled, DSA calibrated, 9.6GHz matching

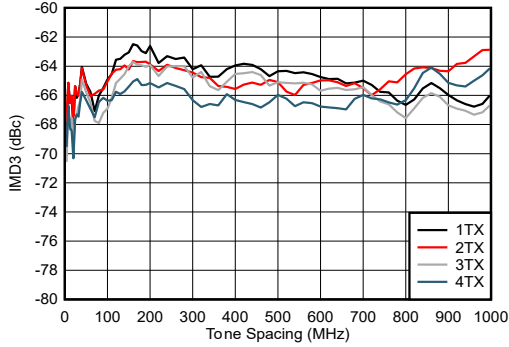

Figure 4-257. TX IMD3 vs Tone Spacing at 9.61GHz

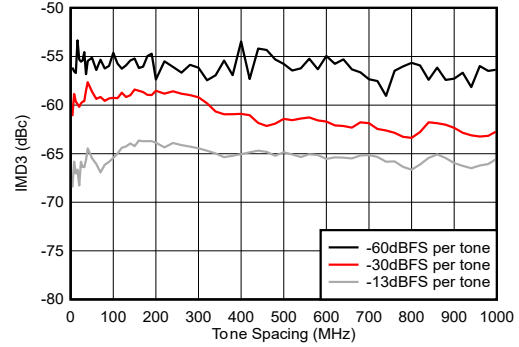

Figure 4-258. TX IMD3 vs Tone Spacing at 9.61GHz

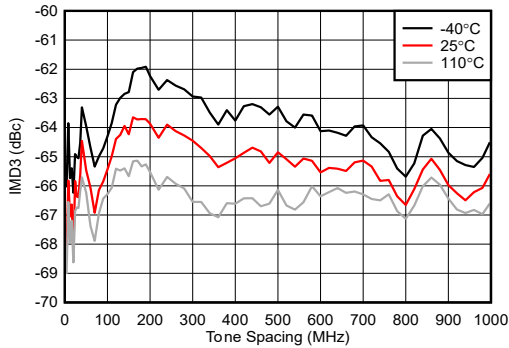

Figure 4-259. TX IMD3 vs Tone Spacing at 9.61GHz

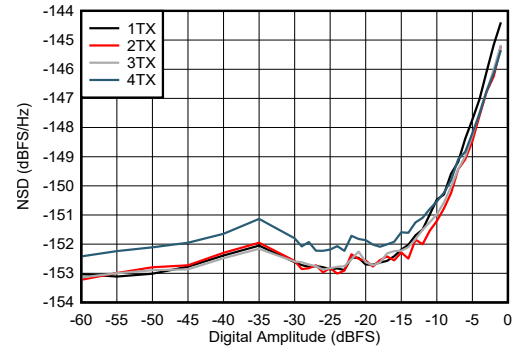

Figure 4-260. TX NSD vs Digital Amplitude at 9.61GHz

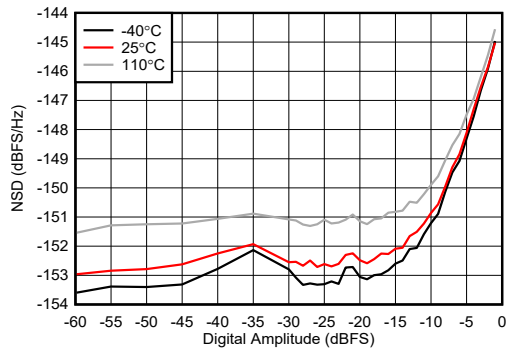

Figure 4-261. TX NSD vs Digital Amplitude at 9.61GHz

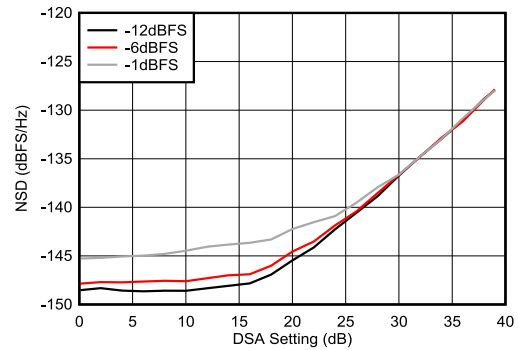
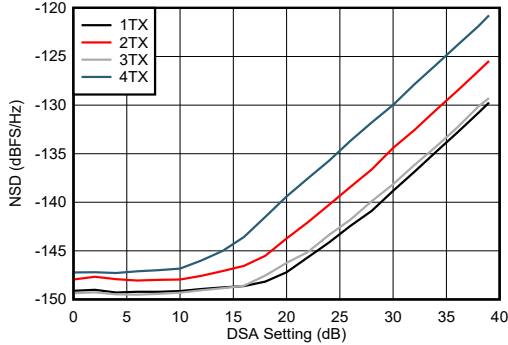

Figure 4-262. TX NSD vs DSA Setting at 9.61GHz

4.12.7 TX Typical Characteristics at 9.6GHz (continued)

Typical values at $T_A = +25^\circ\text{C}$ with nominal supplies. Default conditions: TX input data rate = 1474.56MSPS, $f_{DAC} = 11796.48\text{MSPS}$ (8x interpolation), Mixed mode, 1st Nyquist zone output, PLL clock mode with $f_{REF} = 491.52\text{MHz}$, $A_{OUT} = -1\text{dBFS}$, DSA = 0dB, Sin(x)/x enabled, DSA calibrated, 9.6GHz matching



4-263. TX NSD vs DSA Setting at 9.61GHz

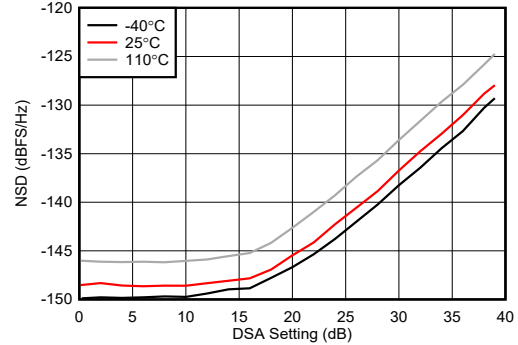

4-264. TX NSD vs DSA Setting at 9.61GHz

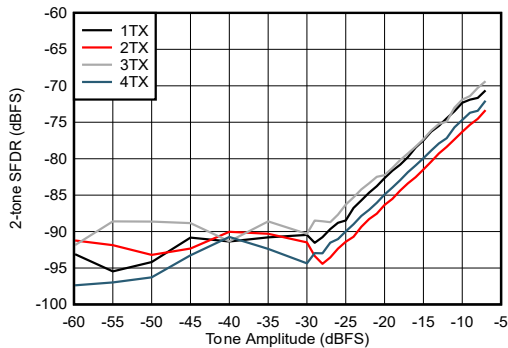

50 MHz tone spacing

4-265. TX 2-tone SFDR vs Digital Amplitude at 9.61GHz

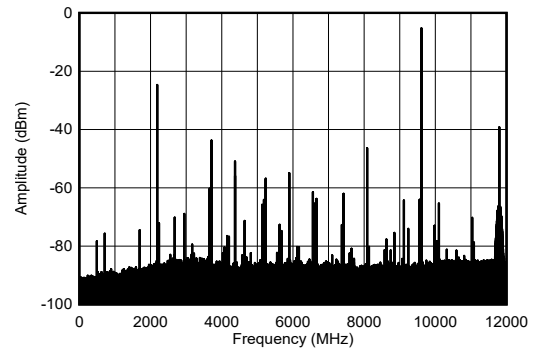

Includes PCB and cable losses.

4-266. TX Single Tone Spectrum at 9.61GHz and -1dBFS (wideband)

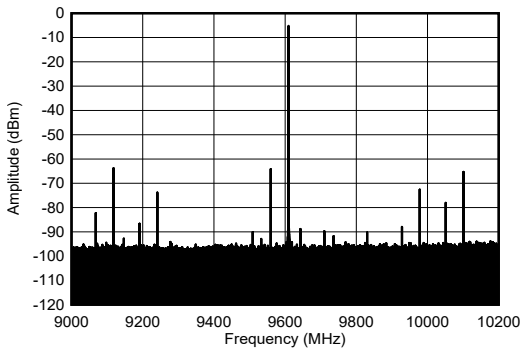

Includes PCB and cable losses.

4-267. TX Single Tone Spectrum at 9.61GHz and -1dBFS (1.2GHz BW)

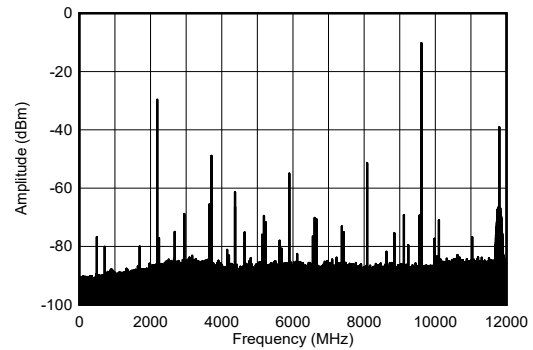

Includes PCB and cable losses.

4-268. TX Single Tone Spectrum at 9.61GHz and -6dBFS (wideband)

4.12.7 TX Typical Characteristics at 9.6GHz (continued)

Typical values at $T_A = +25^\circ\text{C}$ with nominal supplies. Default conditions: TX input data rate = 1474.56MSPS, $f_{\text{DAC}} = 11796.48\text{MSPS}$ (8x interpolation), Mixed mode, 1st Nyquist zone output, PLL clock mode with $f_{\text{REF}} = 491.52\text{MHz}$, $A_{\text{OUT}} = -1\text{dBFS}$, DSA = 0dB, Sin(x)/x enabled, DSA calibrated, 9.6GHz matching

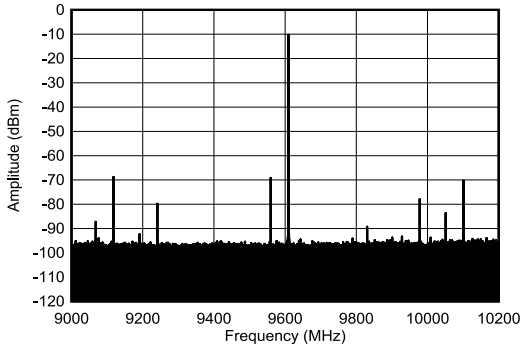

Includes PCB and cable losses.

図 4-269. TX Single Tone Spectrum at 9.61GHz and -6dBFS (1.2GHz BW)

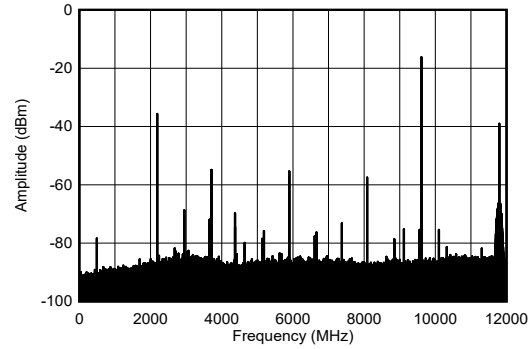

Includes PCB and cable losses.

図 4-270. TX Single Tone Spectrum at 9.61GHz and -12dBFS (wideband)

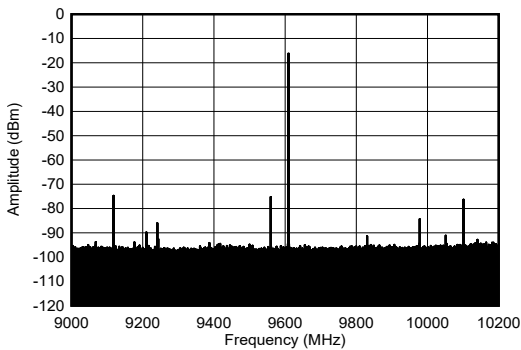

Includes PCB and cable losses.

図 4-271. TX Single Tone Spectrum at 9.61GHz and -12dBFS (1.2GHz BW)

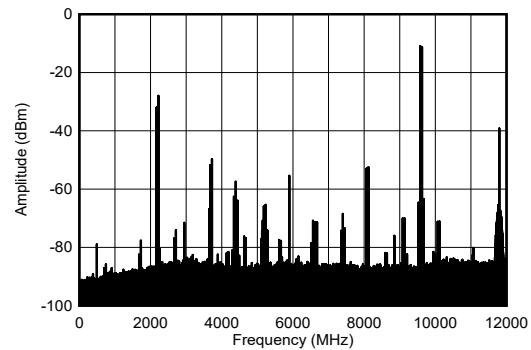

Includes PCB and cable losses, 50MHz tone spacing.

図 4-272. TX 2-Tone Spectrum at 9.61GHz and -7dBFS (wideband)

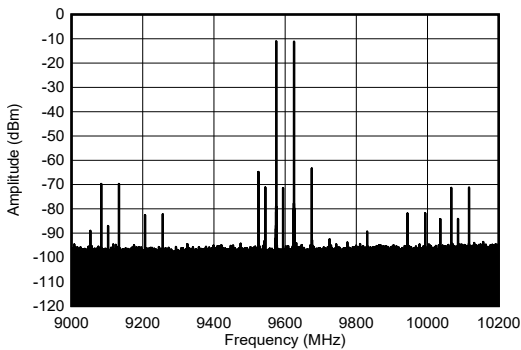

Includes PCB and cable losses, 50MHz tone spacing.

図 4-273. TX 2-Tone Spectrum at 9.61GHz and -7dBFS (1.2GHz BW)

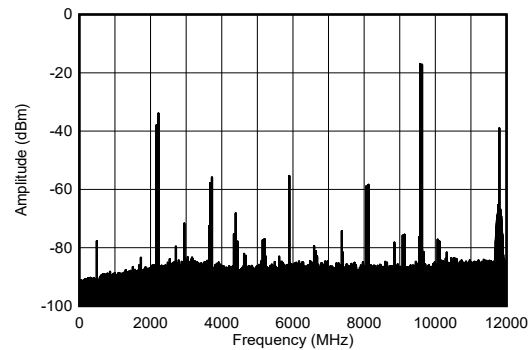

Includes PCB and cable losses, 50MHz tone spacing.

図 4-274. TX 2-Tone Spectrum at 9.61GHz and -13dBFS (wideband)

4.12.7 TX Typical Characteristics at 9.6GHz (continued)

Typical values at $T_A = +25^\circ\text{C}$ with nominal supplies. Default conditions: TX input data rate = 1474.56MSPS, $f_{\text{DAC}} = 11796.48\text{MSPS}$ (8x interpolation), Mixed mode, 1st Nyquist zone output, PLL clock mode with $f_{\text{REF}} = 491.52\text{MHz}$, $A_{\text{OUT}} = -1\text{dBFS}$, DSA = 0dB, Sin(x)/x enabled, DSA calibrated, 9.6GHz matching

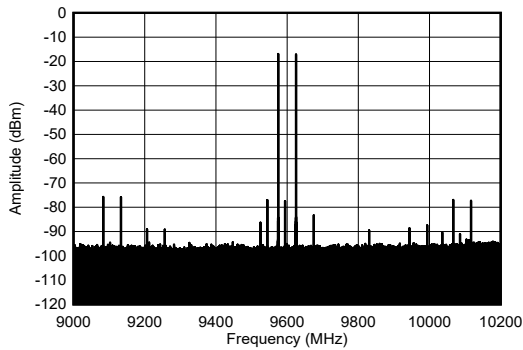

Includes PCB and cable losses, 50MHz tone spacing.

图 4-275. TX 2-Tone Spectrum at 9.61GHz and -13dBFS (1.2GHz BW)

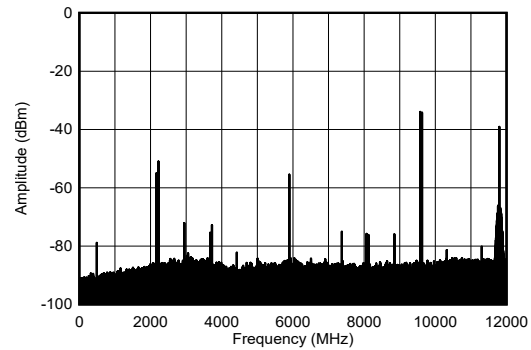

Includes PCB and cable losses, 50MHz tone spacing.

图 4-276. TX 2-Tone Spectrum at 9.61GHz and -30dBFS Each (wideband)

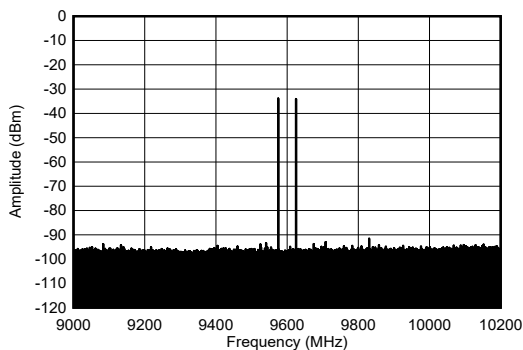

Includes PCB and cable losses, 50MHz tone spacing.

图 4-277. TX 2-Tone Spectrum at 9.61GHz and -30dBFS Each (1.2GHz BW)

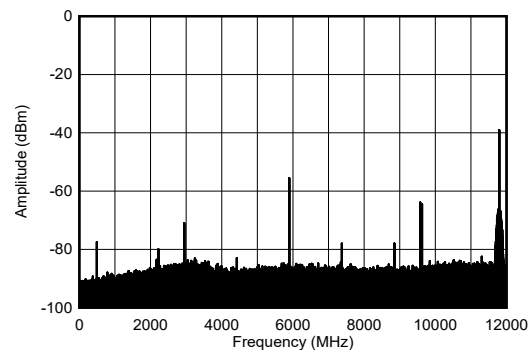

Includes PCB and cable losses, 50MHz tone spacing.

图 4-278. TX 2-Tone Spectrum at 9.61GHz and -60dBFS Each (wideband)

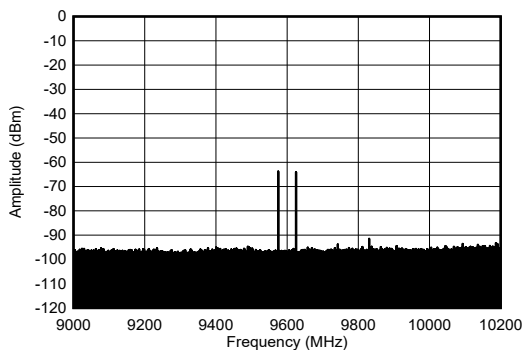

Includes PCB and cable losses, 50MHz tone spacing.

图 4-279. TX 2-Tone Spectrum at 9.61GHz and -60dBFS Each (1.2GHz BW)

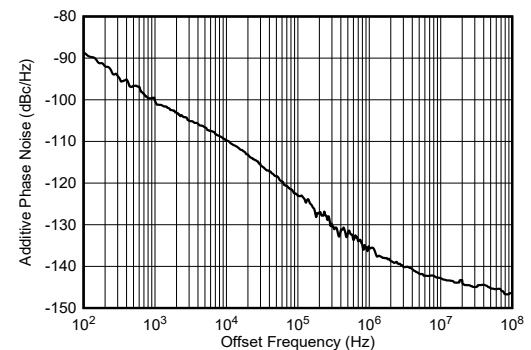

Single sideband, external clock mode, input clock phase noise removed

图 4-280. TX Additive Phase Noise vs Offset Frequency at 9.61GHz

4.12.7 TX Typical Characteristics at 9.6GHz (continued)

Typical values at $T_A = +25^\circ\text{C}$ with nominal supplies. Default conditions: TX input data rate = 1474.56MSPS, $f_{DAC} = 11796.48\text{MSPS}$ (8x interpolation), Mixed mode, 1st Nyquist zone output, PLL clock mode with $f_{REF} = 491.52\text{MHz}$, $A_{OUT} = -1\text{dBFS}$, DSA = 0dB, Sin(x)/x enabled, DSA calibrated, 9.6GHz matching

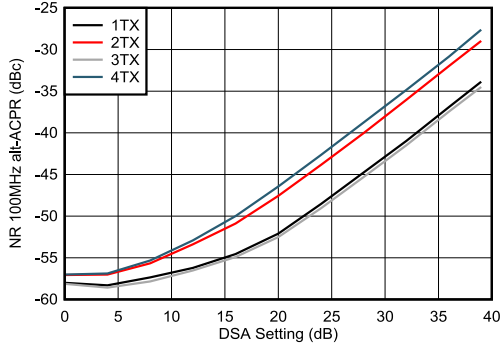

4-281. TX NR100MHz ACPR vs DSA Setting at 9.61GHz
NR100MHz alt-ACPR vs DSA Setting at 9.61GHz

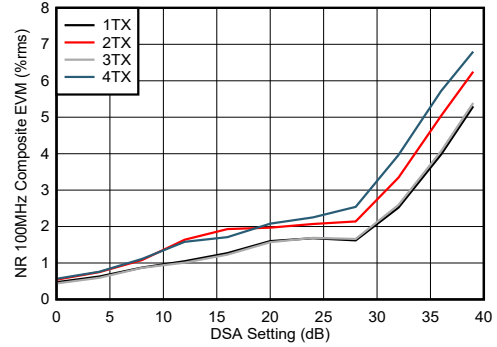

4-282. TX NR100MHz EVM vs DSA Setting at 9.61GHz

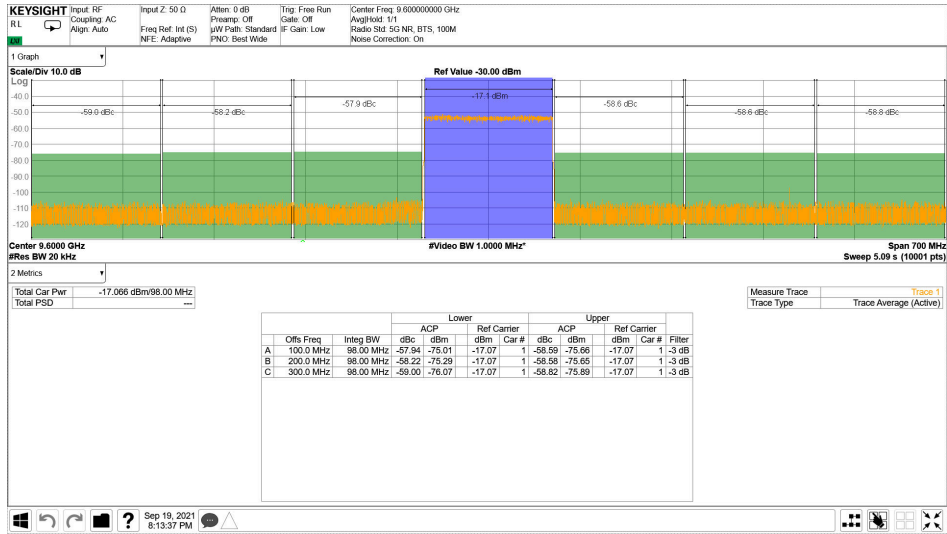

Includes PCB and cable losses.

4-283. TX NR100MHz Output Spectrum at 9.61GHz

4.12.7 TX Typical Characteristics at 9.6GHz (continued)

Typical values at $T_A = +25^\circ\text{C}$ with nominal supplies. Default conditions: TX input data rate = 1474.56MSPS, $f_{DAC} = 11796.48\text{MSPS}$ (8x interpolation), Mixed mode, 1st Nyquist zone output, PLL clock mode with $f_{REF} = 491.52\text{MHz}$, $A_{OUT} = -1\text{dBFS}$, DSA = 0dB, Sin(x)/x enabled, DSA calibrated, 9.6GHz matching

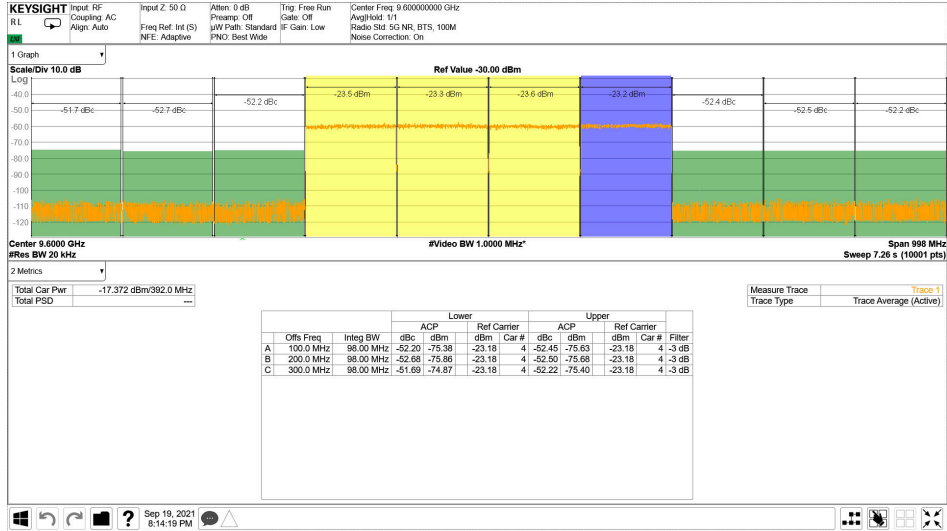

Includes PCB and cable losses.

4-284. TX 4xNR100MHz Output Spectrum at 9.61GHz

4.12.8 RX Typical Characteristics at 800MHz

Typical values at $T_A = +25^\circ\text{C}$, ADC Sampling Rate = 2949.12GHz. Default conditions: output sample rate = 491.52MSPS (decimate by 6), PLL clock mode with $f_{REF} = 491.52\text{MHz}$, $A_{IN} = -3\text{dBFS}$, DSA setting = 4dB.

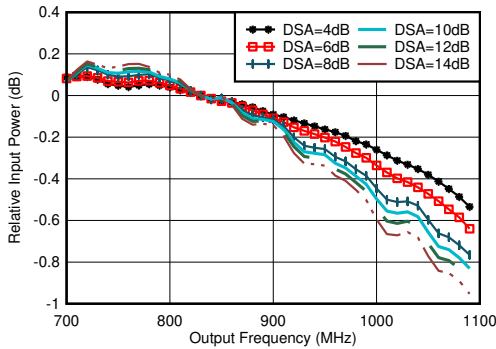

With 0.8GHz matching, normalized to 830MHz

4-285. RX In-Band Gain Flatness for Channel 1RX, $f_{IN} = 830\text{MHz}$

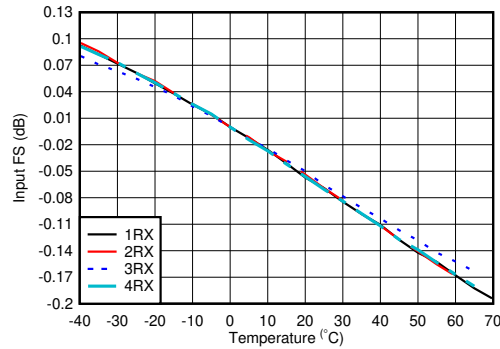

With 0.8GHz matching, normalized to fullscale at 25°C for each channel

4-286. RX Input Fullscale vs Temperature and Channel at 800MHz

4.12.8 RX Typical Characteristics at 800MHz (continued)

Typical values at $T_A = +25^\circ\text{C}$, ADC Sampling Rate = 2949.12GHz. Default conditions: output sample rate = 491.52MSPS (decimate by 6), PLL clock mode with $f_{REF} = 491.52\text{MHz}$, $A_{IN} = -3\text{dBFS}$, DSA setting = 4dB.

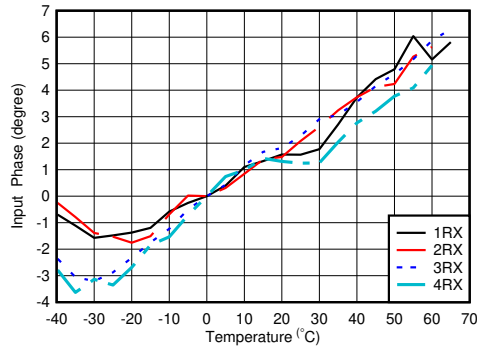

With 0.8GHz matching, normalized to phase at 25°C

4-287. RX Input Phase vs Temperature and DSA at $f_{OUT} = 0.8\text{GHz}$

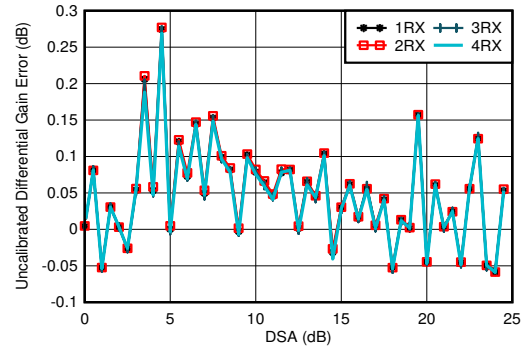

With 0.8GHz matching

Differential Amplitude Error = $P_{IN}(\text{DSA Setting} - 1) - P_{IN}(\text{DSA Setting}) + 1$

4-288. RX Uncalibrated Differential Amplitude Error vs DSA Setting at 0.8GHz

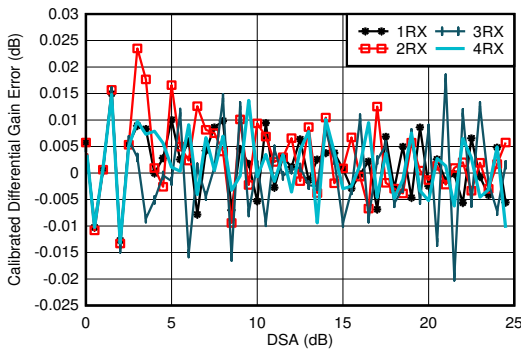

With 0.8GHz matching

Differential Amplitude Error = $P_{IN}(\text{DSA Setting} - 1) - P_{IN}(\text{DSA Setting}) + 1$

4-289. RX Calibrated Differential Amplitude Error vs DSA Setting at 0.8GHz

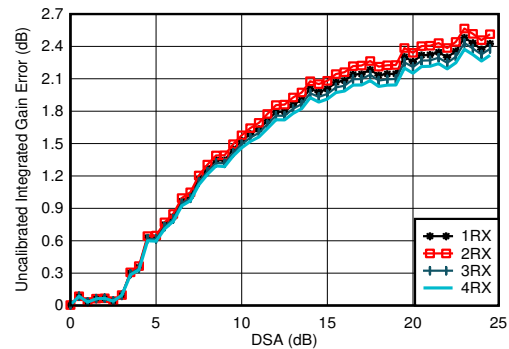

With 0.8GHz matching

Integrated Amplitude Error = $P_{IN}(\text{DSA Setting}) - P_{IN}(\text{DSA Setting} = 0) + (\text{DSA Setting})$

4-290. RX Uncalibrated Integrated Amplitude Error vs DSA Setting at 0.8GHz

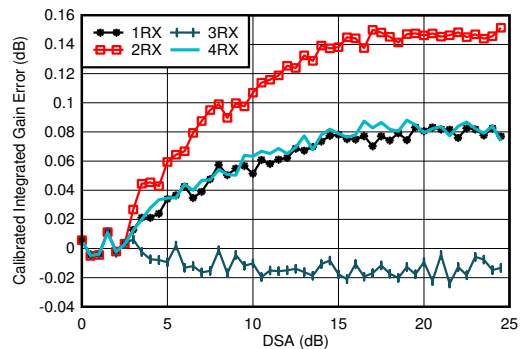

With 0.8GHz matching

Integrated Amplitude Error = $P_{IN}(\text{DSA Setting}) - P_{IN}(\text{DSA Setting} = 0) + (\text{DSA Setting})$

4-291. RX Calibrated Integrated Amplitude Error vs DSA Setting at 2.6GHz

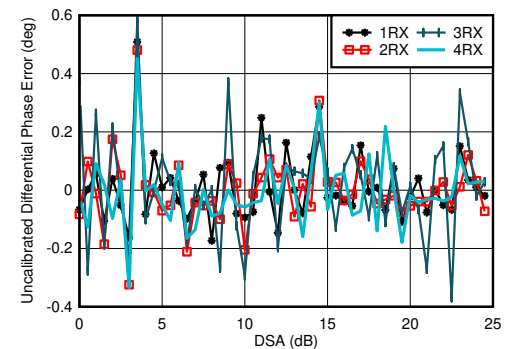

With 0.8GHz matching

Differential Phase Error = $\text{Phase}_{IN}(\text{DSA Setting} - 1) - \text{Phase}_{IN}(\text{DSA Setting})$

4-292. RX Uncalibrated Differential Phase Error vs DSA Setting at 0.8GHz

4.12.8 RX Typical Characteristics at 800MHz (continued)

Typical values at $T_A = +25^\circ\text{C}$, ADC Sampling Rate = 2949.12GHz. Default conditions: output sample rate = 491.52MSPS (decimate by 6), PLL clock mode with $f_{REF} = 491.52\text{MHz}$, $A_{IN} = -3\text{dBFS}$, DSA setting = 4dB.

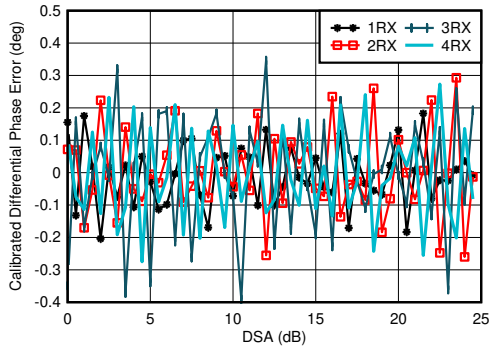

With 0.8GHz matching
 Differential Phase Error = $\text{Phase}_{IN}(\text{DSA Setting} - 1) - \text{Phase}_{IN}(\text{DSA Setting})$

图 4-293. RX Calibrated Differential Phase Error vs DSA Setting at 0.8GHz

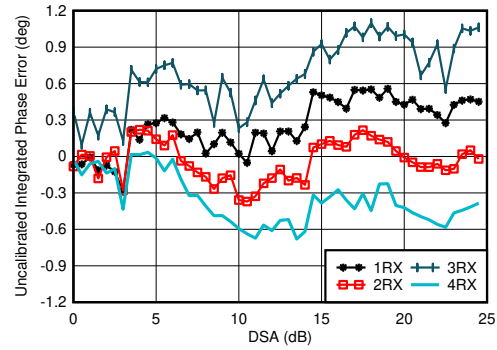

With 0.8GHz matching
 Integrated Phase Error = $\text{Phase}(\text{DSA Setting}) - \text{Phase}(\text{DSA Setting} = 0)$

图 4-294. RX Uncalibrated Integrated Phase Error vs DSA Setting at 0.8GHz

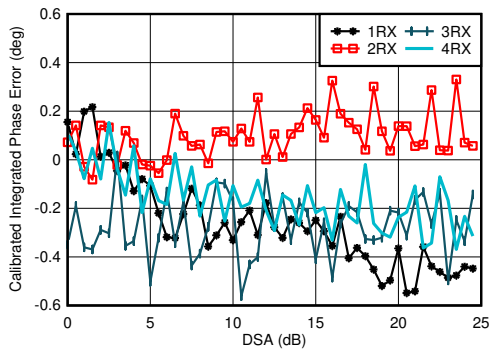

With 0.8GHz matching
 Integrated Phase Error = $\text{Phase}(\text{DSA Setting}) - \text{Phase}(\text{DSA Setting} = 0)$

图 4-295. RX Calibrated Integrated Phase Error vs DSA Setting at 0.8GHz

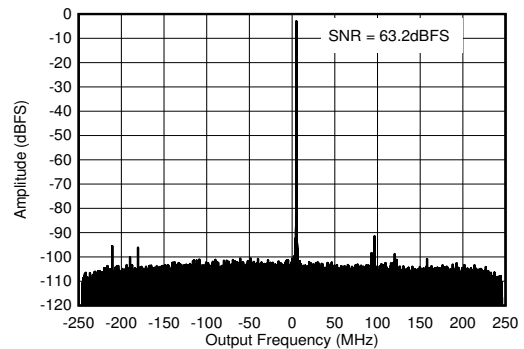

With 0.8GHz matching, $f_{IN} = 840\text{MHz}$, $A_{IN} = -3\text{dBFS}$

图 4-296. RX Output FFT at 0.8GHz

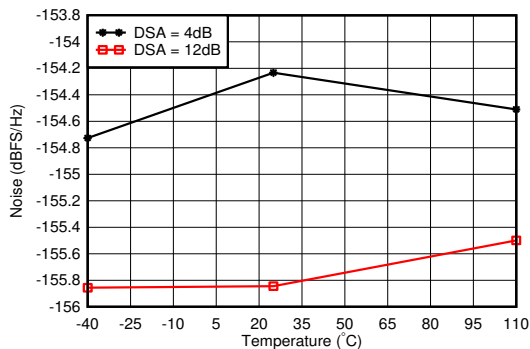

With 0.8GHz matching, 12.5MHz offset from tone

图 4-297. RX Noise Spectral Density vs Temperature at 0.8GHz

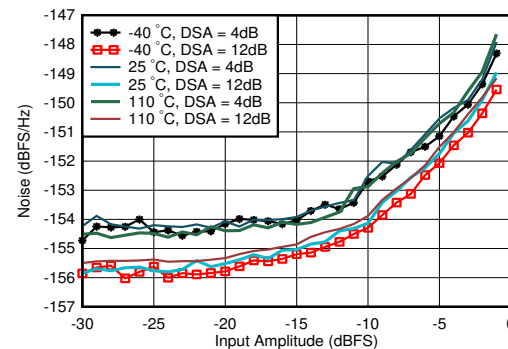

With 0.8GHz matching, DSA Setting = 12dB, 12.5MHz offset from tone

图 4-298. RX Noise Spectral Density vs Input Amplitude and Temperature at 0.8GHz

4.12.8 RX Typical Characteristics at 800MHz (continued)

Typical values at $T_A = +25^\circ\text{C}$, ADC Sampling Rate = 2949.12MHz. Default conditions: output sample rate = 491.52MSPS (decimate by 6), PLL clock mode with $f_{REF} = 491.52\text{MHz}$, $A_{IN} = -3\text{dBFS}$, DSA setting = 4dB.

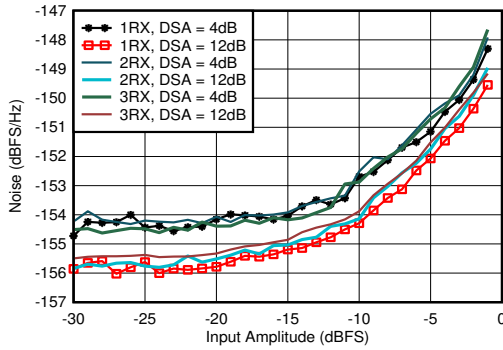

With 0.8GHz matching, 12.5MHz offset from tone

4-299. RX Noise Spectral Density vs Input Amplitude and Channel at 0.8GHz

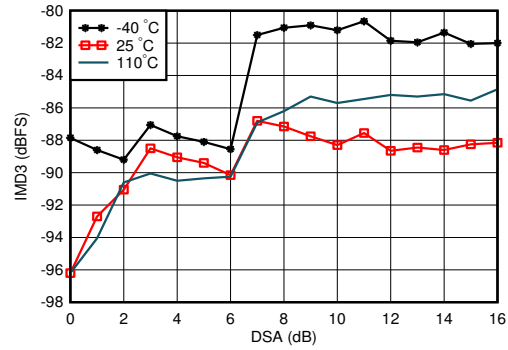

A. With 0.8GHz matching, each tone -7dBFS , tone spacing = 20MHz

4-300. RX IMD3 vs DSA Setting and Temperature at 0.8GHz

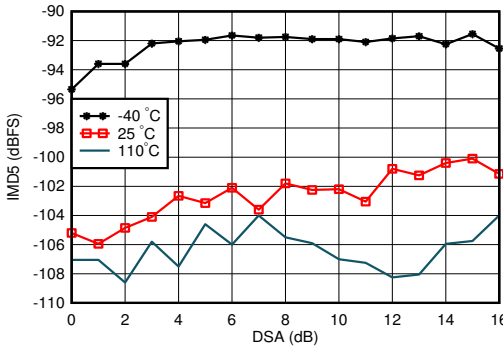

With 0.8GHz matching, each tone -7dBFS , tone spacing = 20MHz

4-301. RX IMD5 vs DSA Setting and Temperature at 0.8GHz

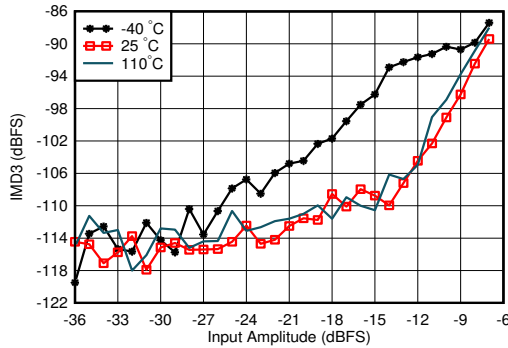

With 0.8GHz matching, tone spacing = 20MHz, DSA = 4dB

4-302. RX IMD3 vs Input Level and Temperature at 0.8GHz

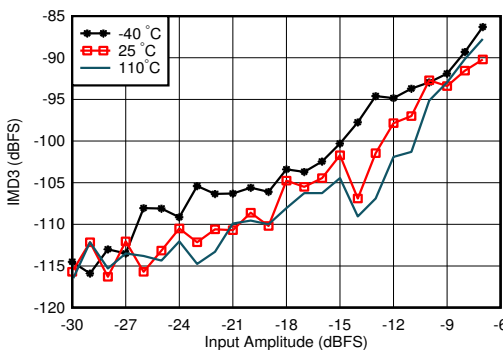

With 0.8GHz matching, tone spacing = 20MHz, DSA = 12dB

4-303. RX IMD3 vs Input Level and Temperature at 0.8GHz

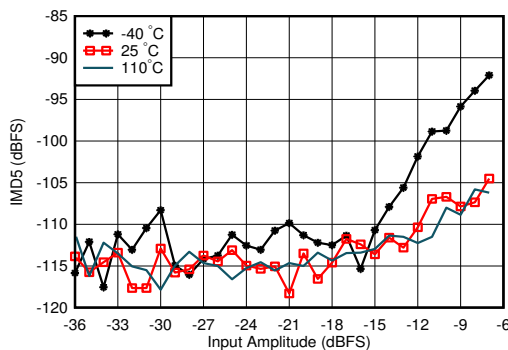

With 0.8GHz matching, tone spacing = 20MHz, DSA = 12dB

4-304. RX IMD5 vs Input Level and Temperature at 0.8GHz

4.12.8 RX Typical Characteristics at 800MHz (continued)

Typical values at $T_A = +25^\circ\text{C}$, ADC Sampling Rate = 2949.12GHz. Default conditions: output sample rate = 491.52MSPS (decimate by 6), PLL clock mode with $f_{REF} = 491.52\text{MHz}$, $A_{IN} = -3\text{dBFS}$, DSA setting = 4dB.

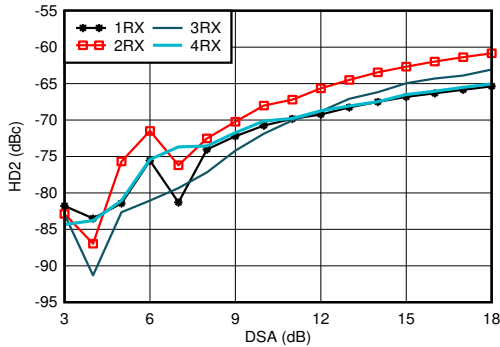

With 0.8GHz matching, measured after HD2 trim, DDC bypass mode (TI only mode for characterization)

4-305. RX HD2 vs DSA Setting and Channel at 0.8GHz

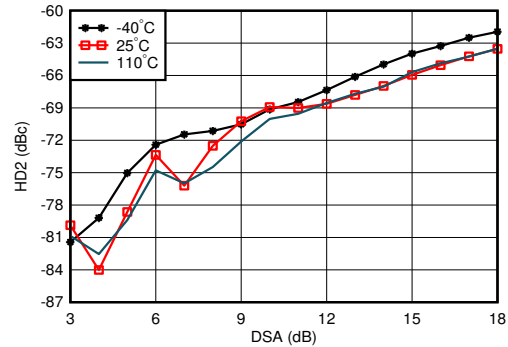

With 0.8GHz matching, measured after HD2 trim, DDC bypass mode (TI only mode for characterization)

4-306. RX HD2 vs DSA Setting and Temperature at 0.8GHz

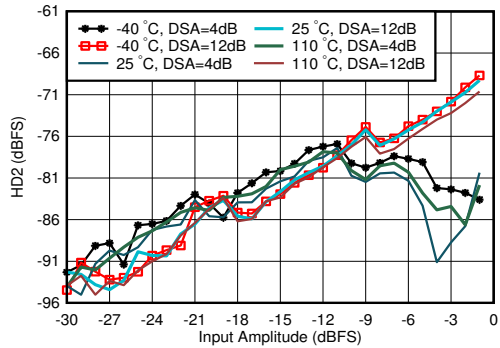

With 0.8GHz matching, measured after HD2 trim, DDC bypass mode (TI only mode for characterization)

4-307. RX HD2 vs Input Level and Temperature at 0.8GHz

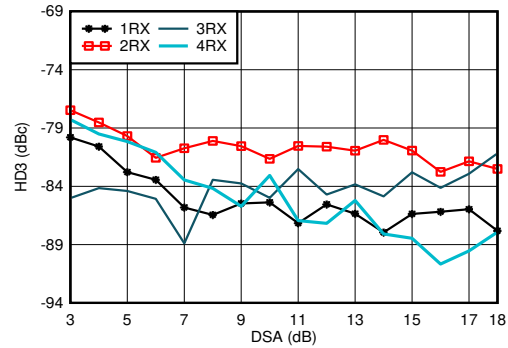

With 0.8GHz matching, DDC bypass mode (TI only mode for characterization)

4-308. RX HD3 vs DSA Setting and Channel at 0.8GHz

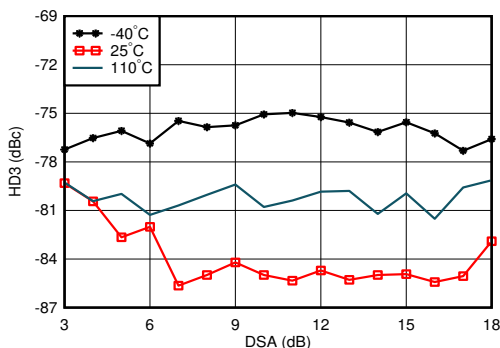

With 0.8GHz matching, DDC bypass mode (TI only mode for characterization)

4-309. RX HD3 vs DSA Setting and Temperature at 0.8GHz

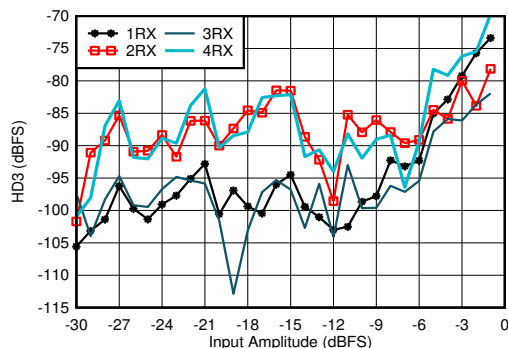

With 0.8GHz matching, DDC bypass mode (TI only mode for characterization)

4-310. RX HD3 vs Input Level and Channel at 0.8GHz

4.12.8 RX Typical Characteristics at 800MHz (continued)

Typical values at $T_A = +25^\circ\text{C}$, ADC Sampling Rate = 2949.12GHz. Default conditions: output sample rate = 491.52MSPS (decimate by 6), PLL clock mode with $f_{REF} = 491.52\text{MHz}$, $A_{IN} = -3\text{dBFS}$, DSA setting = 4dB.

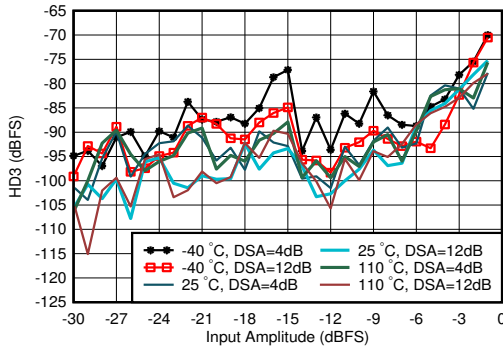

With 0.8GHz matching, DDC bypass mode (TI only mode for characterization)

Figure 4-311. RX HD3 vs Input Level and Temperature at 0.8GHz

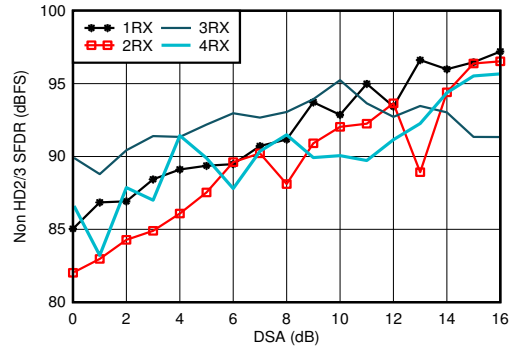

With 0.8GHz matching

Figure 4-312. RX Non-HD2/3 vs DSA Setting at 0.8GHz

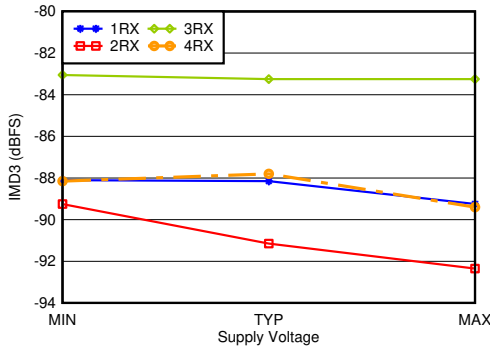

With 0.8GHz matching, -7dBFS each tone, 20MHz tone spacing, all supplies at MIN, TYP, or MAX recommended operating voltages

Figure 4-313. RX IMD3 vs Supply and Channel at 0.8GHz

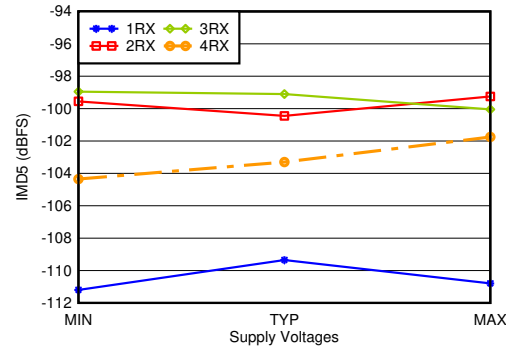

With 0.8GHz matching, -7dBFS each tone, 20MHz tone spacing, all supplies at MIN, TYP, or MAX recommended operating voltages

Figure 4-314. RX IMD5 vs Supply and Channel at 0.8GHz

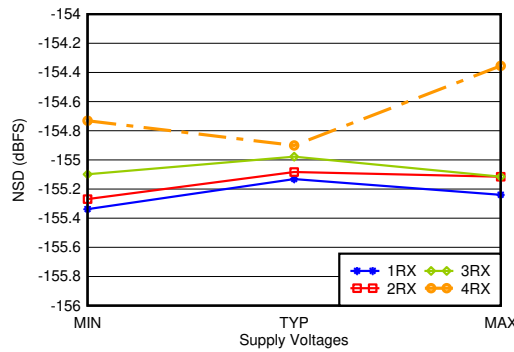

With 0.8GHz matching, 12.5MHz offset, all supplies at MIN, TYP, or MAX recommended operating voltages

Figure 4-315. RX Noise Spectral Density vs Supply and Channel at 0.8GHz

4.12.9 RX Typical Characteristics at 1.75-1.9GHz

Typical values at $T_A = +25^\circ\text{C}$, ADC Sampling Rate = 2949.12MHz. Default conditions: output sample rate = 491.52MSPS (decimate by 6), PLL clock mode with $f_{REF} = 491.52\text{MHz}$, $A_{IN} = -3\text{dBFS}$, DSA setting = 4dB.

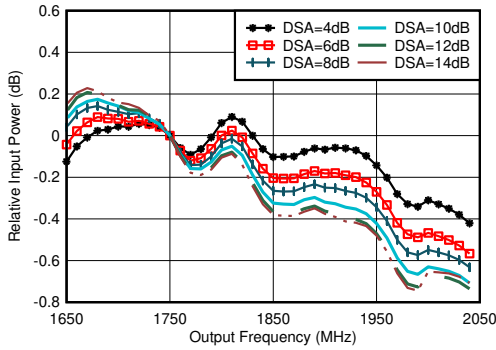

With 1.8GHz matching, normalized to 1.75GHz

4-316. RX In-Band Gain Flatness, $f_{IN} = 1750\text{MHz}$

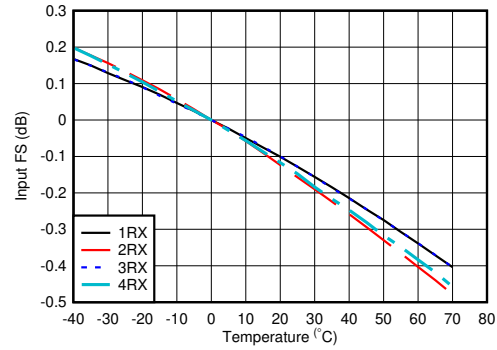

With 1.8GHz matching, normalized to fullscale at 25°C for each channel

4-317. RX Input Fullscale vs Temperature and Channel at 1.75GHz

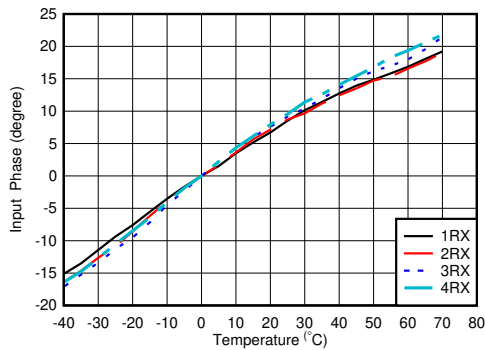

With 2.6GHz matching, normalized to phase at 25°C

4-318. RX Input Phase vs Temperature and DSA at $f_{IN} = 1.75\text{GHz}$

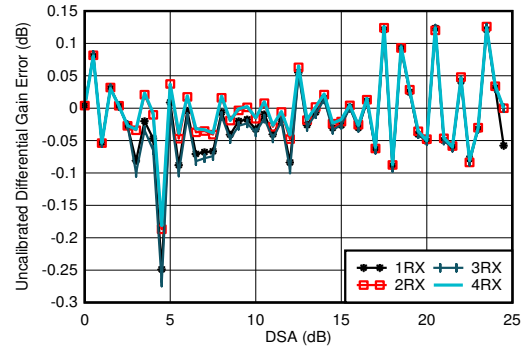

With 1.8GHz matching

Differential Amplitude Error = $P_{IN}(\text{DSA Setting} - 1) - P_{IN}(\text{DSA Setting}) + 1$

4-319. RX Uncalibrated Differential Amplitude Error vs DSA Setting at 1.75GHz

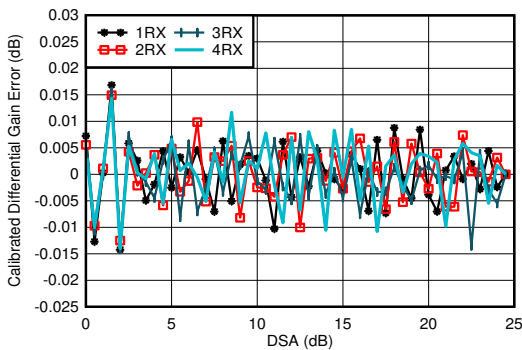

With 1.8GHz matching

Differential Amplitude Error = $P_{IN}(\text{DSA Setting} - 1) - P_{IN}(\text{DSA Setting}) + 1$

4-320. RX Calibrated Differential Amplitude Error vs DSA Setting at 1.75GHz

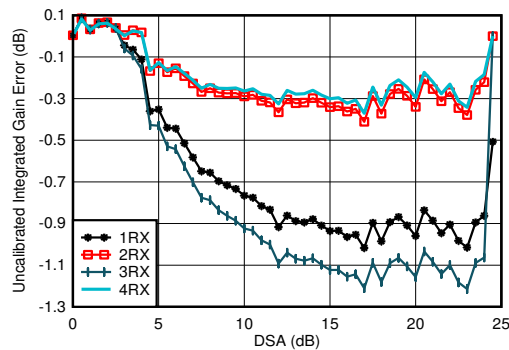

With 1.8GHz matching

Integrated Amplitude Error = $P_{IN}(\text{DSA Setting}) - P_{IN}(\text{DSA Setting} = 0) + (\text{DSA Setting})$

4-321. RX Uncalibrated Integrated Amplitude Error vs DSA Setting at 1.75GHz

4.12.9 RX Typical Characteristics at 1.75-1.9GHz (continued)

Typical values at $T_A = +25^\circ\text{C}$, ADC Sampling Rate = 2949.12GHz. Default conditions: output sample rate = 491.52MSPS (decimate by 6), PLL clock mode with $f_{REF} = 491.52\text{MHz}$, $A_{IN} = -3\text{dBFS}$, DSA setting = 4dB.

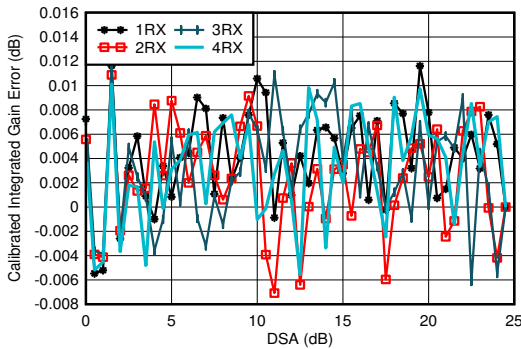

With 1.8GHz matching
Integrated Amplitude Error = $P_{IN}(\text{DSA Setting}) - P_{IN}(\text{DSA Setting} = 0) + (\text{DSA Setting})$

4-322. RX Calibrated Integrated Amplitude Error vs DSA Setting at 1.75GHz

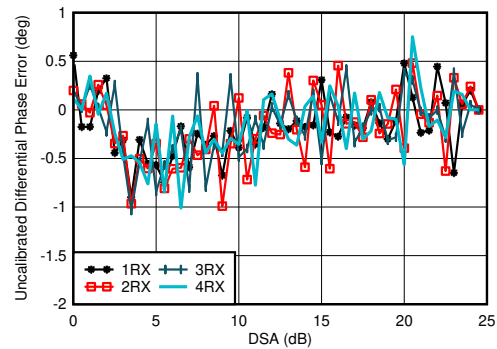

With 1.8GHz matching
Differential Phase Error = $\text{Phase}_{IN}(\text{DSA Setting} - 1) - \text{Phase}_{IN}(\text{DSA Setting})$

4-323. RX Uncalibrated Differential Phase Error vs DSA Setting at 1.75GHz

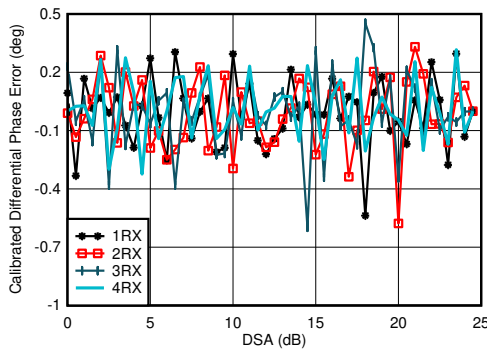

With 1.8GHz matching
Differential Phase Error = $\text{Phase}_{IN}(\text{DSA Setting} - 1) - \text{Phase}_{IN}(\text{DSA Setting})$

4-324. RX Calibrated Differential Phase Error vs DSA Setting at 1.75GHz

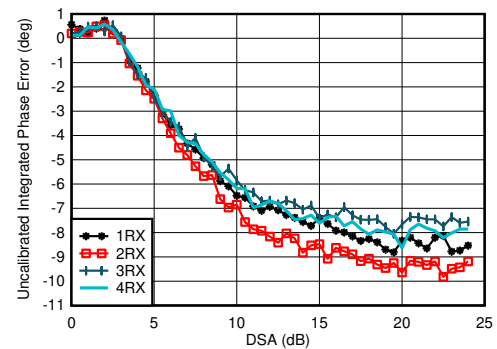

With 1.8GHz matching
Integrated Phase Error = $\text{Phase}(\text{DSA Setting}) - \text{Phase}(\text{DSA Setting} = 0)$

4-325. RX Uncalibrated Integrated Phase Error vs DSA Setting at 1.75GHz

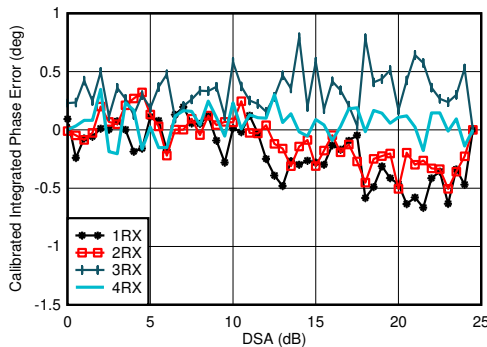

With 1.8GHz matching
Integrated Phase Error = $\text{Phase}(\text{DSA Setting}) - \text{Phase}(\text{DSA Setting} = 0)$

4-326. RX Calibrated Integrated Phase Error vs DSA Setting at 1.75GHz

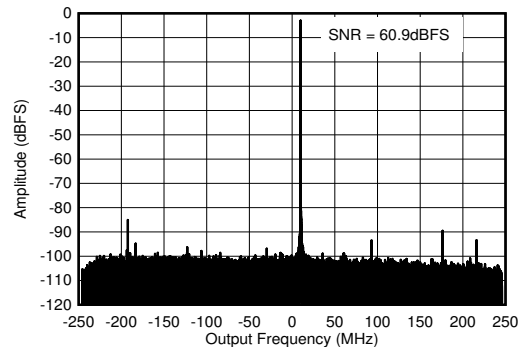

With 1.8GHz matching, $f_{IN} = 2610\text{MHz}$, $A_{IN} = -3\text{dBFS}$

4-327. RX Output FFT at 1.75GHz

4.12.9 RX Typical Characteristics at 1.75-1.9GHz (continued)

Typical values at $T_A = +25^\circ\text{C}$, ADC Sampling Rate = 2949.12MHz. Default conditions: output sample rate = 491.52MSPS (decimate by 6), PLL clock mode with $f_{REF} = 491.52\text{MHz}$, $A_{IN} = -3\text{dBFS}$, DSA setting = 4dB.

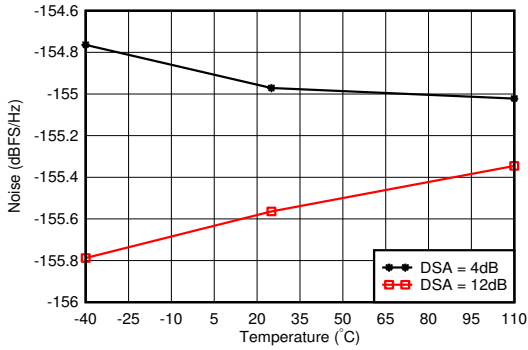

With 1.8GHz matching, 12.5MHz offset from tone

4-328. RX Noise Spectral Density vs Temperature at 1.75GHz

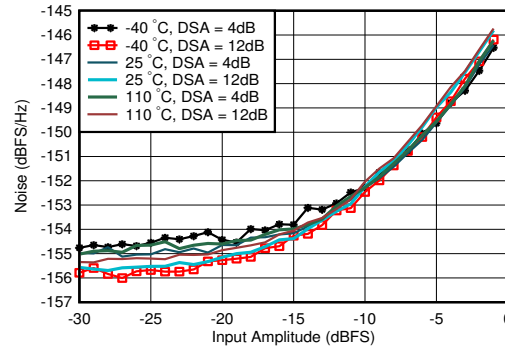

With 1.8GHz matching, DSA Setting = 12dB, 12.5MHz offset from tone

4-329. RX Noise Spectral Density vs Input Amplitude and Temperature at 1.75GHz

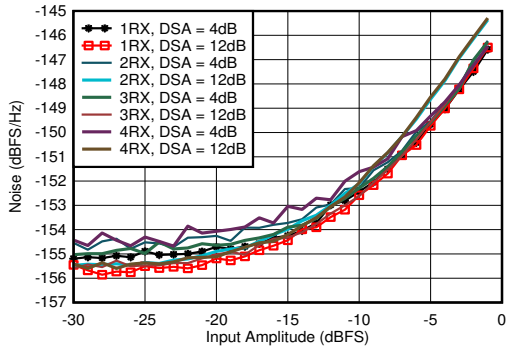

With 1.8GHz matching, 12.5MHz offset from tone

4-330. RX Noise Spectral Density vs Input Amplitude and Channel at 1.75GHz

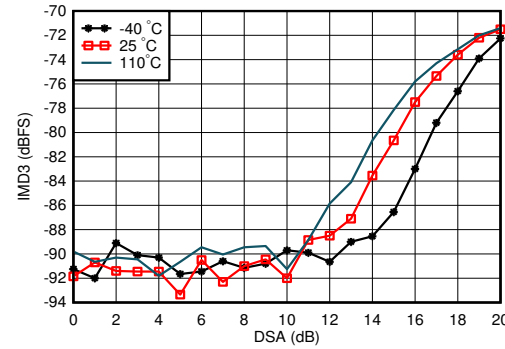

With 1.8GHz matching, each tone -7dBFS , tone spacing = 20MHz

4-331. RX IMD3 vs DSA Setting and Temperature at 1.75GHz

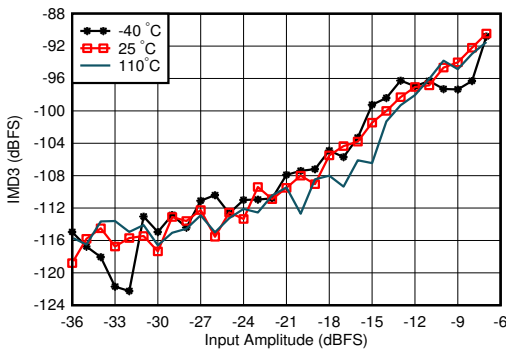

With 1.8GHz matching, tone spacing = 20MHz, DSA = 4dB

4-332. RX IMD3 vs Input Level and Temperature at 1.75GHz

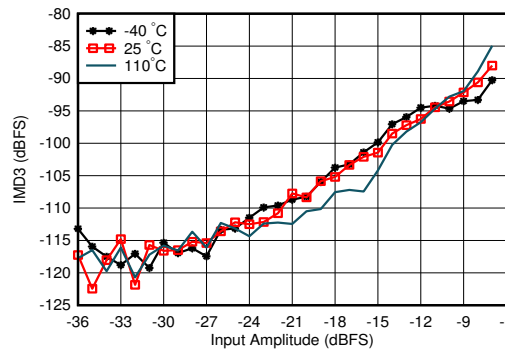

With 1.8GHz matching, tone spacing = 20MHz, DSA = 12dB

4-333. RX IMD3 vs Input Level and Temperature at 1.75GHz

4.12.9 RX Typical Characteristics at 1.75-1.9GHz (continued)

Typical values at $T_A = +25^\circ\text{C}$, ADC Sampling Rate = 2949.12MHz. Default conditions: output sample rate = 491.52MSPS (decimate by 6), PLL clock mode with $f_{REF} = 491.52\text{MHz}$, $A_{IN} = -3\text{dBFS}$, DSA setting = 4dB.

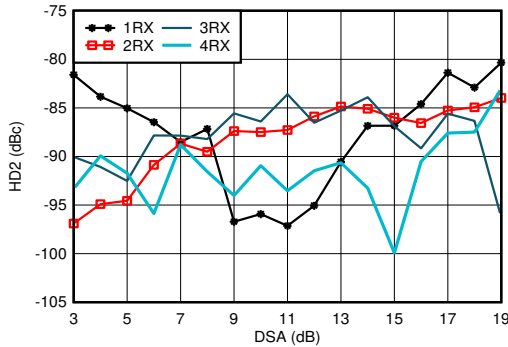

With 1.8GHz matching, $f_{in} = 1900\text{MHz}$, measured after HD2 trim, DDC bypass mode (TI only mode for characterization)

4-334. RX HD2 vs DSA Setting and Channel at 1.9 GHz

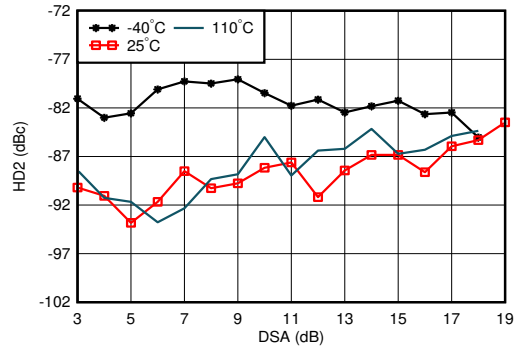

With 1.8GHz matching, $f_{in} = 1900\text{MHz}$, measured after HD2 trim, DDC bypass mode (TI only mode for characterization)

4-335. RX HD2 vs DSA Setting and Temperature at 1.9 GHz

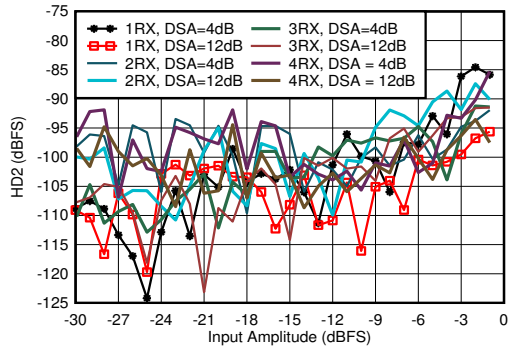

With 1.8GHz matching, $f_{in} = 1900\text{MHz}$, measured after HD2 trim, DDC bypass mode (TI only mode for characterization)

4-336. RX HD2 vs Input Amplitude and Channel at 1.9GHz

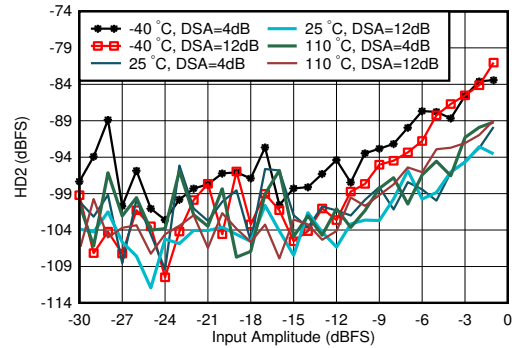

With 1.8GHz matching, $f_{in} = 1900\text{MHz}$, measured after HD2 trim, DDC bypass mode (TI only mode for characterization)

4-337. RX HD2 vs Input Amplitude and Temperature at 1.9GHz

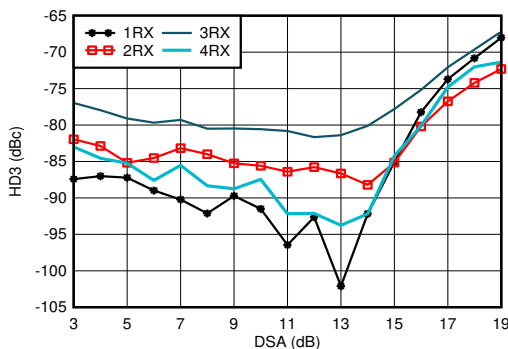

With 1.8GHz matching, $f_{in} = 1900\text{MHz}$, DDC bypass mode (TI only mode for characterization)

4-338. RX HD3 vs DSA Setting and Channel at 1.9GHz

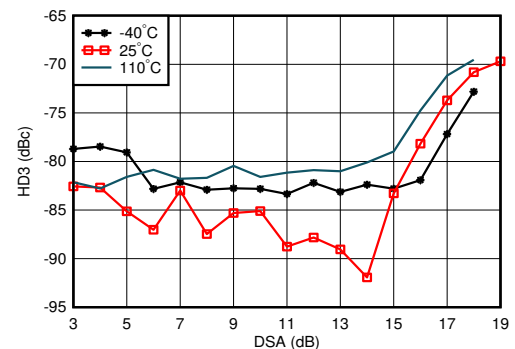

With 1.8GHz matching, $f_{in} = 1900\text{MHz}$, DDC bypass mode (TI only mode for characterization)

4-339. RX HD3 vs DSA Setting and Temperature at 1.9GHz

4.12.9 RX Typical Characteristics at 1.75-1.9GHz (continued)

Typical values at $T_A = +25^\circ\text{C}$, ADC Sampling Rate = 2949.12MHz. Default conditions: output sample rate = 491.52MSPS (decimate by 6), PLL clock mode with $f_{REF} = 491.52\text{MHz}$, $A_{IN} = -3\text{dBFS}$, DSA setting = 4dB.

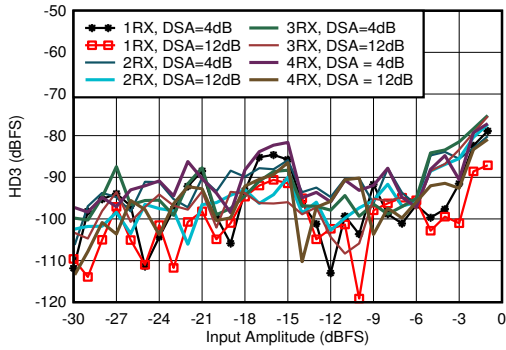

With 1.8GHz matching, $f_{in} = 1900\text{MHz}$, DDC bypass mode (TI only mode for characterization)

4-340. RX HD3 vs Input Level and Channel at 1.9GHz

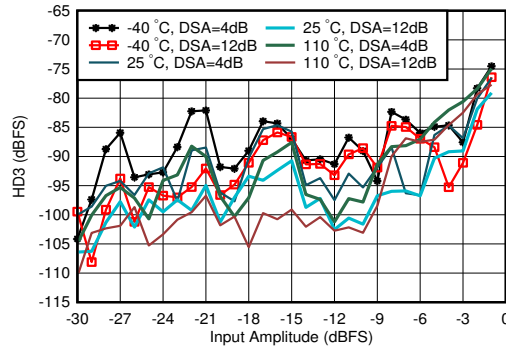

With 1.8GHz matching, $f_{in} = 1900\text{MHz}$, DDC bypass mode (TI only mode for characterization)

4-341. RX HD3 vs Input Level and Temperature at 1.9GHz

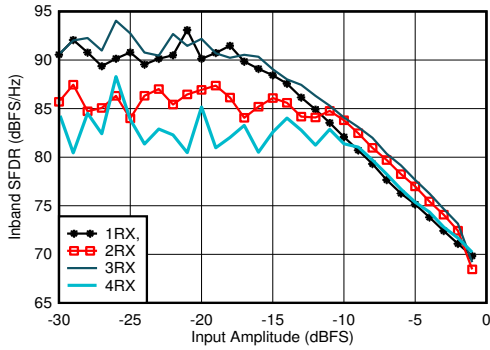

With 1.8GHz matching, decimated by 3

4-342. RX In-Band SFDR ($\pm 400\text{MHz}$) vs Input Amplitude at 1.75GHz

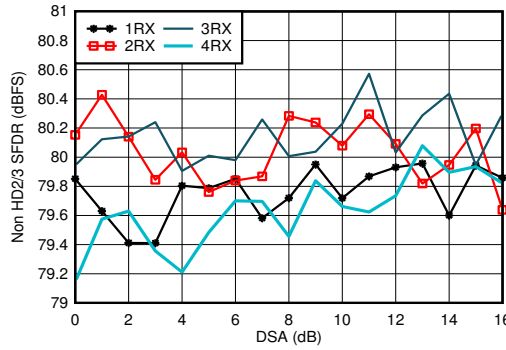

With 1.8GHz matching

4-343. RX Non-HD2/3 vs DSA Setting at 1.75GHz

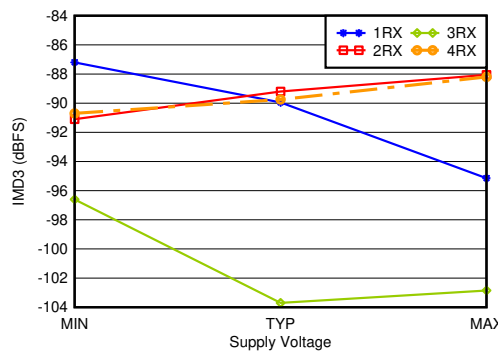

With 1.8GHz matching, -7dBFS each tone, 20MHz tone spacing, all supplies at MIN, TYP, or MAX recommended operating voltages

4-344. RX IMD3 vs Supply and Channel at 1.75GHz

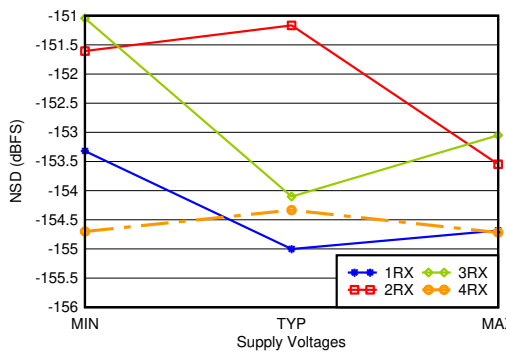

With 1.8GHz matching, 12.5MHz offset, all supplies at MIN, TYP, or MAX recommended operating voltages

4-345. RX Noise Spectral Density vs Supply and Channel at 1.75GHz

4.12.10 RX Typical Characteristics at 2.6GHz

Typical values at $T_A = +25^\circ\text{C}$, ADC Sampling Rate = 2949.12GHz. Default conditions: output sample rate = 491.52MSPS (decimate by 6), PLL clock mode with $f_{\text{REF}} = 491.52\text{MHz}$, $A_{\text{IN}} = -3\text{dBFS}$, DSA setting = 4dB.

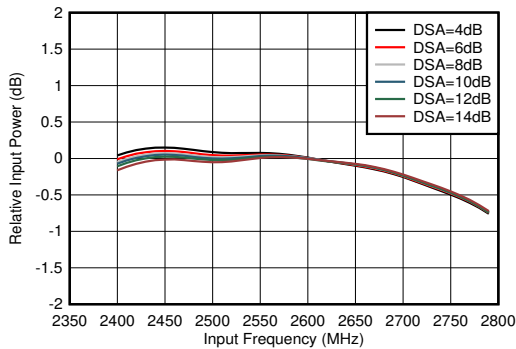

With matching, normalized to power at 2.6GHz for each DSA setting

Figure 4-346. RX Inband Gain Flatness, $f_{\text{IN}} = 2600\text{MHz}$

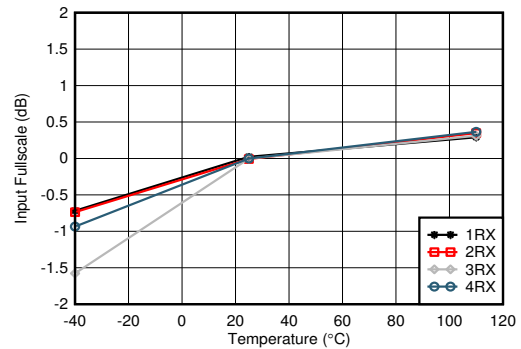

With 2.6GHz matching, normalized to fullscale at 25°C for each channel

Figure 4-347. RX Input Fullscale vs Temperature and Channel at 2.6GHz

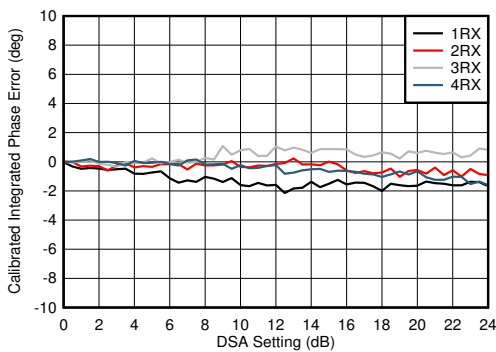

With 2.6GHz matching
Integrated Phase Error = Phase(DSA Setting) – Phase(DSA Setting = 0)

Figure 4-348. RX Calibrated Integrated Phase Error vs DSA Setting at 2.6GHz

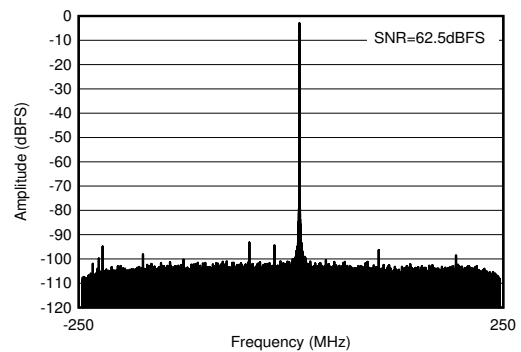

With 2.6GHz matching, $f_{\text{IN}} = 2610\text{MHz}$, $A_{\text{IN}} = -3\text{dBFS}$

Figure 4-349. RX Output FFT at 2.6GHz

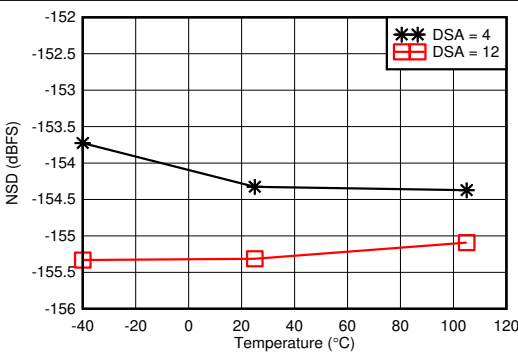

With 2.6GHz matching, 12.5MHz offset from tone

Figure 4-350. RX Noise Spectral Density vs Temperature at 2.6GHz

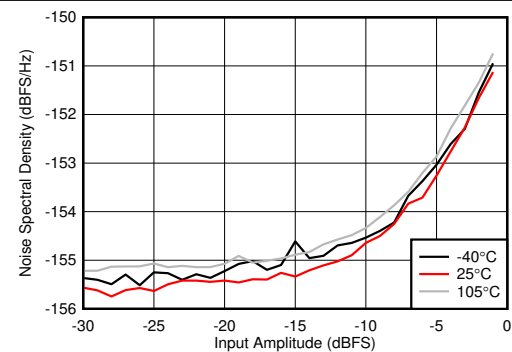

With 2.6GHz matching, DSA Setting = 12dB, 12.5MHz offset from tone

Figure 4-351. RX Noise Spectral Density vs Input Amplitude and Temperature at 2.6GHz

4.12.10 RX Typical Characteristics at 2.6GHz (continued)

Typical values at $T_A = +25^\circ\text{C}$, ADC Sampling Rate = 2949.12GHz. Default conditions: output sample rate = 491.52MSPS (decimate by 6), PLL clock mode with $f_{REF} = 491.52\text{MHz}$, $A_{IN} = -3\text{dBFS}$, DSA setting = 4dB.

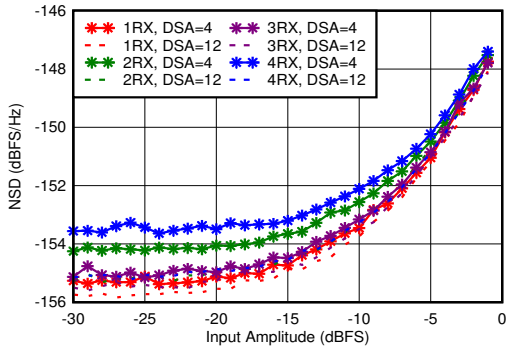

With 2.6GHz matching, 12.5MHz offset from tone

4-352. RX Noise Spectral Density vs Input Amplitude and Channel at 2.6GHz

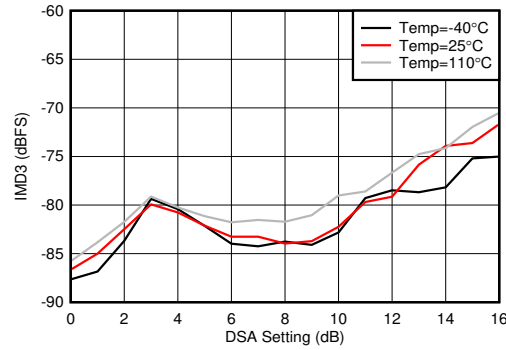

With 2.6GHz matching, each tone -7dBFS , tone spacing = 20MHz

4-353. RX IMD3 vs DSA Setting and Temperature at 2.6GHz

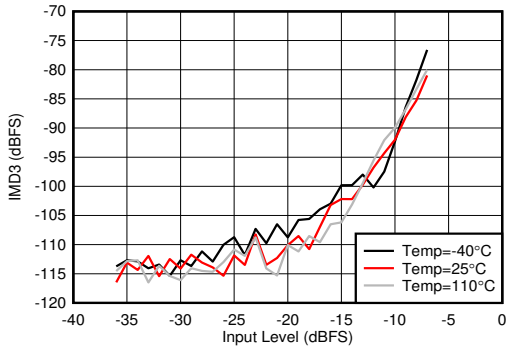

With 2.6GHz matching, tone spacing = 20MHz, DSA = 4dB

4-354. RX IMD3 vs Input Level and Temperature at 2.6GHz

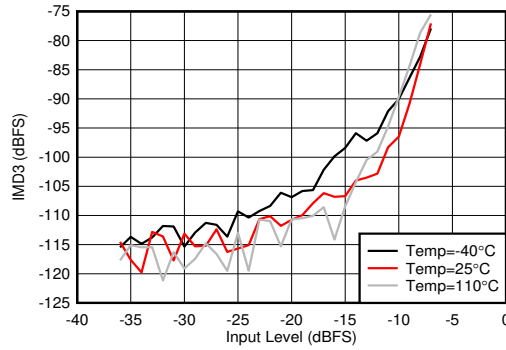

With 2.6GHz matching, tone spacing = 20MHz, DSA = 12dB

4-355. RX IMD3 vs Input Level and Temperature at 2.6GHz

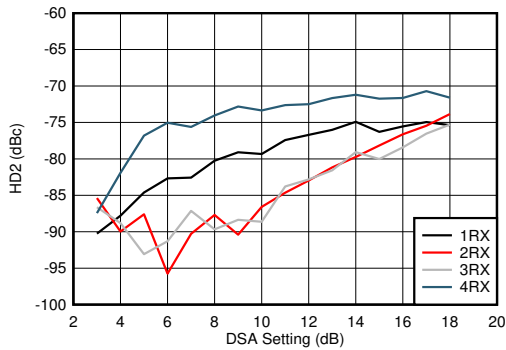

With 2.6GHz matching, DDC bypass mode (TI only mode for characterization)

4-356. RX HD2 vs DSA Setting and Channel at 2.6GHz

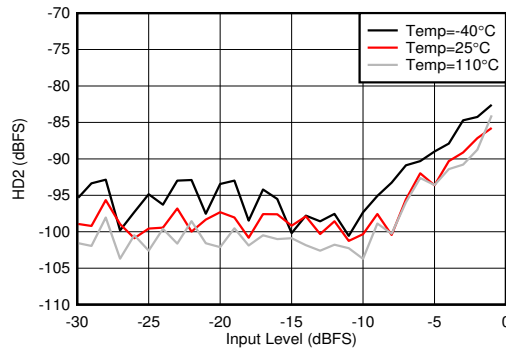

With 2.6GHz matching, DDC bypass mode (TI only mode for characterization)

4-357. RX HD2 vs Input Level and Temperature at 2.6GHz

4.12.10 RX Typical Characteristics at 2.6GHz (continued)

Typical values at $T_A = +25^\circ\text{C}$, ADC Sampling Rate = 2949.12MHz. Default conditions: output sample rate = 491.52MSPS (decimate by 6), PLL clock mode with $f_{REF} = 491.52\text{MHz}$, $A_{IN} = -3\text{dBFS}$, DSA setting = 4dB.

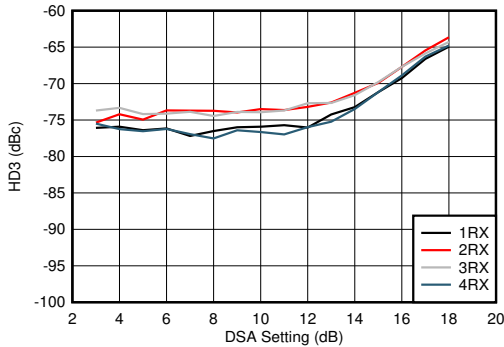

With 2.6GHz matching, DDC bypass mode (TI only mode for characterization)

4-358. RX HD3 vs DSA Setting and Channel at 2.6GHz

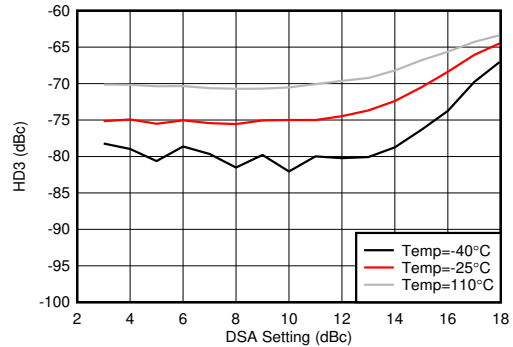

With 2.6GHz matching, DDC bypass mode (TI only mode for characterization)

4-359. RX HD3 vs DSA Setting and Temperature at 2.6GHz

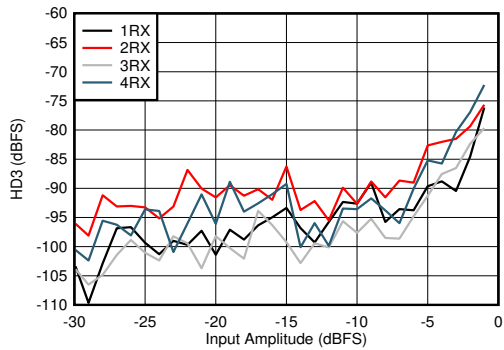

With 2.6GHz matching, DDC bypass mode (TI only mode for characterization)

4-360. RX HD3 vs Input Level and Channel at 2.6GHz

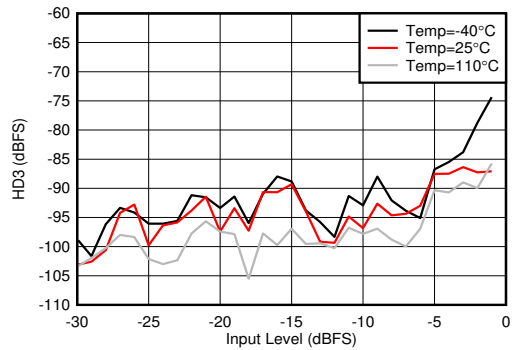

With 2.6GHz matching, DDC bypass mode (TI only mode for characterization)

4-361. RX HD3 vs Input Level and Temperature at 2.6GHz

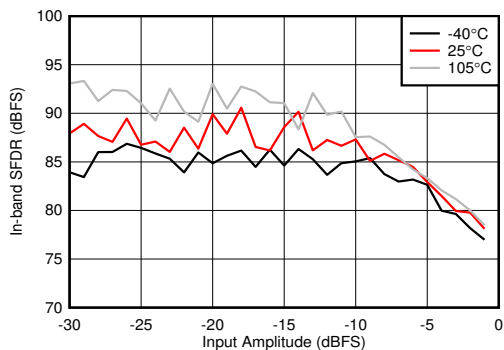

With 2.6GHz matching, decimate by 4

4-362. RX In-Band SFDR ($\pm 300\text{ MHz}$) vs Input Amplitude and Temperature at 2.6GHz

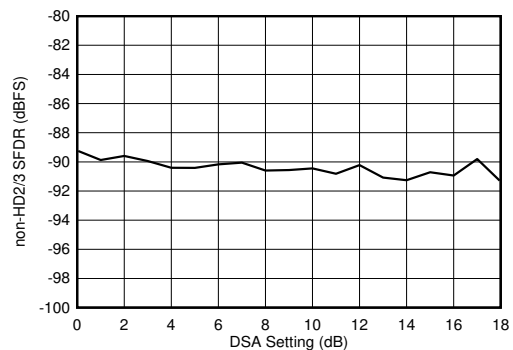

With 2.6GHz matching

4-363. RX Non-HD2/3 vs DSA Setting at 2.6GHz

4.12.10 RX Typical Characteristics at 2.6GHz (continued)

Typical values at $T_A = +25^\circ\text{C}$, ADC Sampling Rate = 2949.12GHz. Default conditions: output sample rate = 491.52MSPS (decimate by 6), PLL clock mode with $f_{REF} = 491.52\text{MHz}$, $A_{IN} = -3\text{dBFS}$, DSA setting = 4dB.

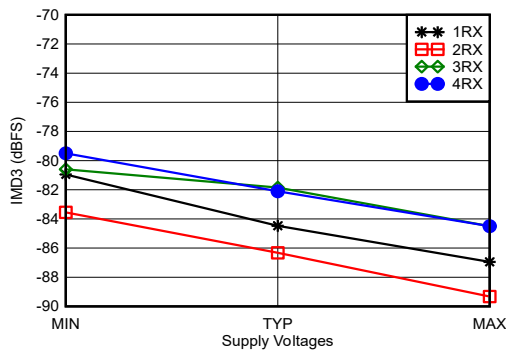

With 2.6GHz matching, -7dBFS each tone, 20MHz tone spacing, all supplies at MIN, TYP, or MAX recommended operating voltages

Figure 4-364. RX IMD3 vs Supply and Channel at 2.6GHz

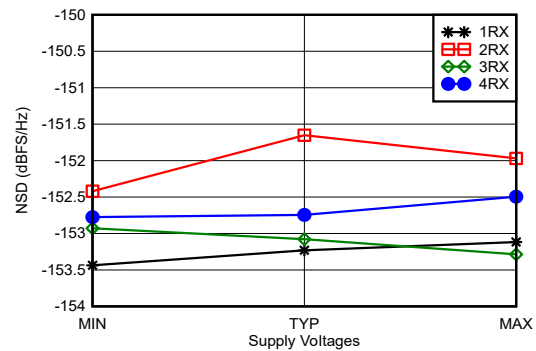

With 2.6GHz matching, 12.5MHz offset, all supplies at MIN, TYP, or MAX recommended operating voltages

Figure 4-365. RX Noise Spectral Density vs Supply and Channel at 2.6GHz

4.12.11 RX Typical Characteristics at 3.5GHz

Typical values at $T_A = +25^\circ\text{C}$, ADC Sampling Rate = 2949.12MHz. Default conditions: output sample rate = 491.52MSPS (decimate by 6), PLL clock mode with $f_{\text{REF}} = 491.52\text{MHz}$, $A_{\text{IN}} = -3\text{dBFS}$, DSA setting = 4dB.

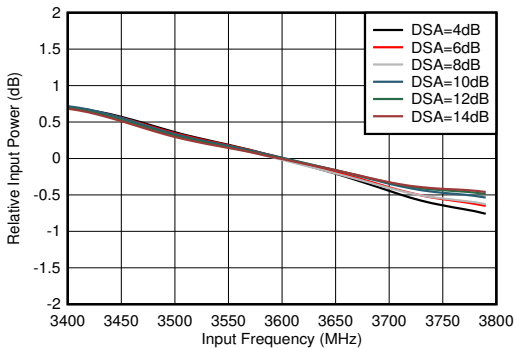

With 3.6GHz matching, normalized to 3.6GHz

4-366. RX In-Band Gain Flatness, $f_{\text{IN}} = 3600\text{MHz}$

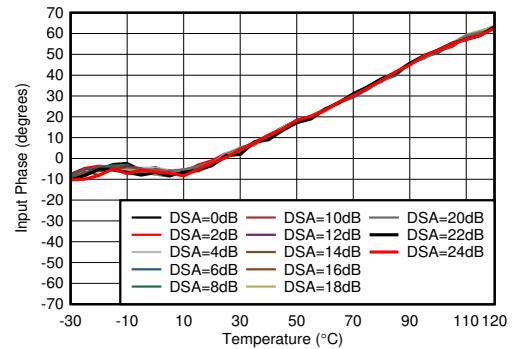

With 3.6GHz matching, normalized to phase at 25°C

4-367. RX Input Phase vs Temperature at 3.6GHz

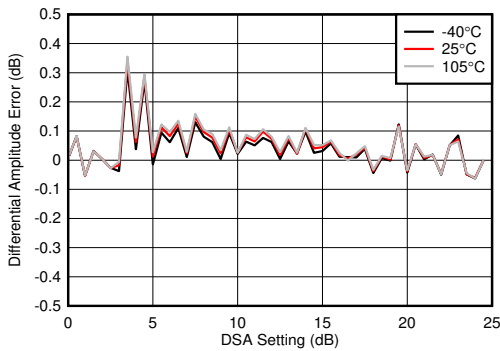

With 3.6GHz matching

$$\text{Differential Amplitude Error} = P_{\text{IN}}(\text{DSA Setting} - 1) - P_{\text{IN}}(\text{DSA Setting}) + 1$$

4-368. RX Uncalibrated Differential Amplitude Error vs DSA Setting at 3.6GHz

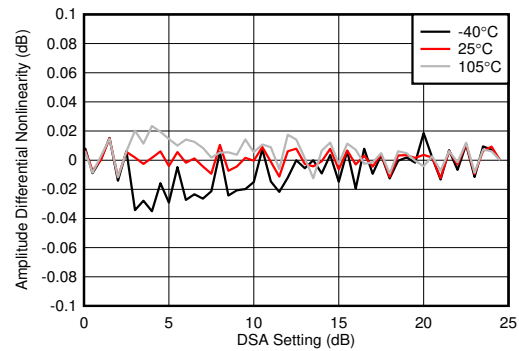

With 3.6GHz matching

$$\text{Differential Amplitude Error} = P_{\text{IN}}(\text{DSA Setting} - 1) - P_{\text{IN}}(\text{DSA Setting}) + 1$$

4-369. RX Calibrated Differential Amplitude Error vs DSA Setting at 3.6GHz

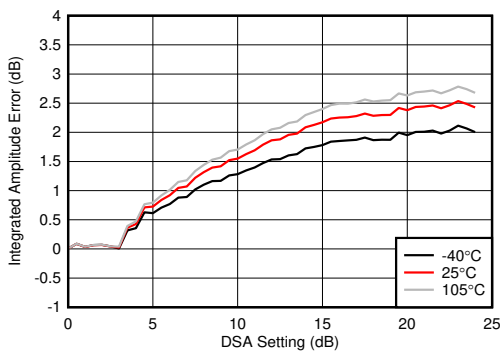

With 3.6GHz matching

$$\text{Integrated Amplitude Error} = P_{\text{IN}}(\text{DSA Setting}) - P_{\text{IN}}(\text{DSA Setting} = 0) + (\text{DSA Setting})$$

4-370. RX Uncalibrated Integrated Amplitude Error vs DSA Setting at 3.6GHz

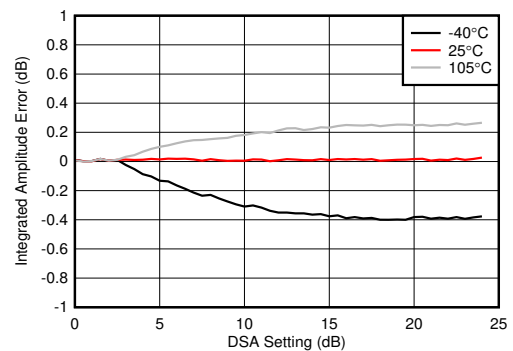

With 3.6GHz matching

$$\text{Integrated Amplitude Error} = P_{\text{IN}}(\text{DSA Setting}) - P_{\text{IN}}(\text{DSA Setting} = 0) + (\text{DSA Setting})$$

4-371. RX Calibrated Integrated Amplitude Error vs DSA Setting at 3.6GHz

4.12.11 RX Typical Characteristics at 3.5GHz (continued)

Typical values at $T_A = +25^\circ\text{C}$, ADC Sampling Rate = 2949.12MHz. Default conditions: output sample rate = 491.52MSPS (decimate by 6), PLL clock mode with $f_{REF} = 491.52\text{MHz}$, $A_{IN} = -3\text{dBFS}$, DSA setting = 4dB.

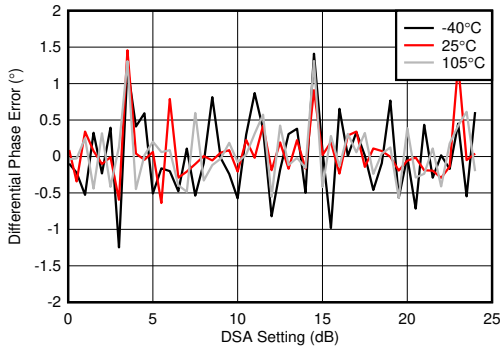

With 3.6GHz matching
 Differential Phase Error = $\text{Phase}_{IN}(\text{DSA Setting} - 1) - \text{Phase}_{IN}(\text{DSA Setting})$

4-372. RX Uncalibrated Phase Error vs DSA Setting at 3.6GHz

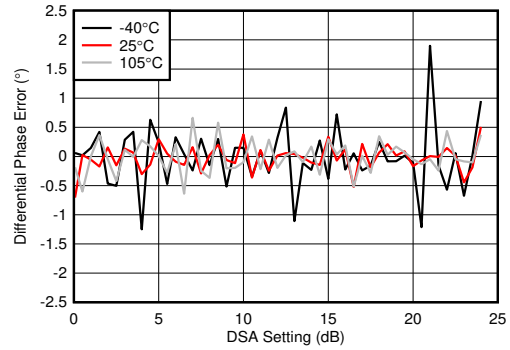

With 3.6GHz matching
 Differential Phase Error = $\text{Phase}_{IN}(\text{DSA Setting} - 1) - \text{Phase}_{IN}(\text{DSA Setting})$

4-373. RX Calibrated Differential Phase Error vs DSA Setting at 3.6GHz

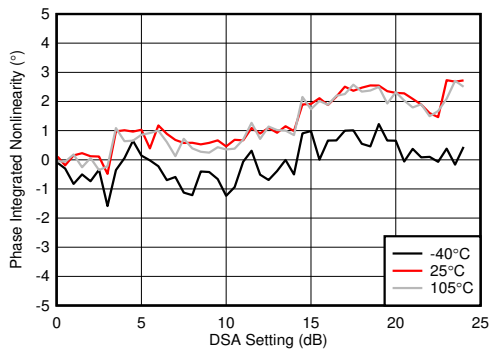

With 3.6GHz matching
 Integrated Phase Error = $\text{Phase}(\text{DSA Setting}) - \text{Phase}(\text{DSA Setting} = 0)$

4-374. RX Uncalibrated Integrated Phase Error vs DSA Setting at 3.6GHz

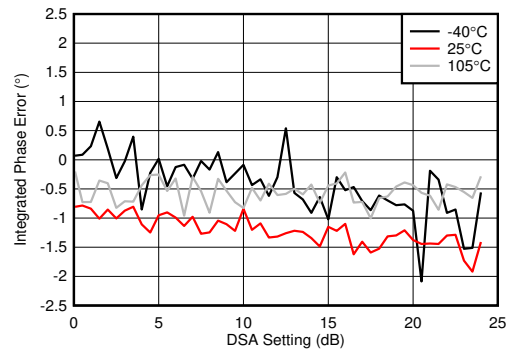

With 3.6GHz matching
 Integrated Phase Error = $\text{Phase}(\text{DSA Setting}) - \text{Phase}(\text{DSA Setting} = 0)$

4-375. RX Calibrated Integrated Phase Error vs DSA Setting at 3.6GHz

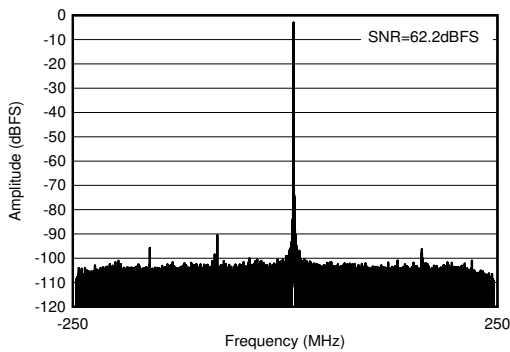

With 3.6GHz matching, $f_{IN} = 3610\text{MHz}$, $A_{IN} = -3\text{dBFS}$

4-376. RX Output FFT at 3.6GHz

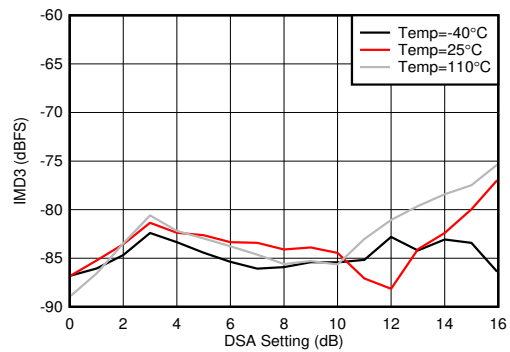

With 3.5 GHz matching, each tone at -7dBFS , 20MHz tone spacing

4-377. RX IMD3 vs DSA Setting and Temperature at 3.6GHz

4.12.11 RX Typical Characteristics at 3.5GHz (continued)

Typical values at $T_A = +25^\circ\text{C}$, ADC Sampling Rate = 2949.12MHz. Default conditions: output sample rate = 491.52MSPS (decimate by 6), PLL clock mode with $f_{REF} = 491.52\text{MHz}$, $A_{IN} = -3\text{dBFS}$, DSA setting = 4dB.

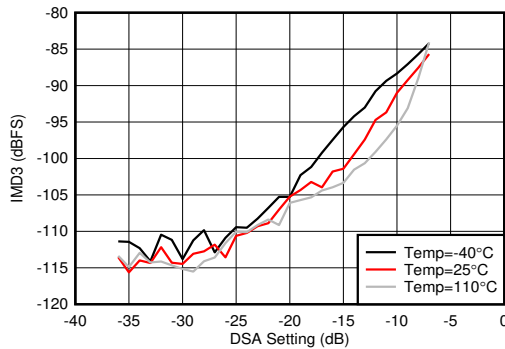

With 3.5GHz matching, 20MHz tone spacing

4-378. RX IMD3 vs Input Level and Temperature at 3.6GHz

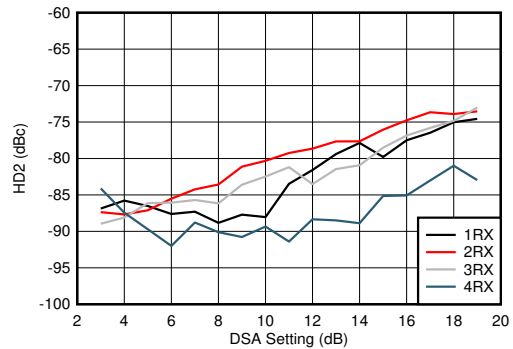

With 3.5GHz matching, DDC bypass mode (TI only mode for characterization)

4-379. RX HD2 vs DSA Setting and Channel at 3.6GHz

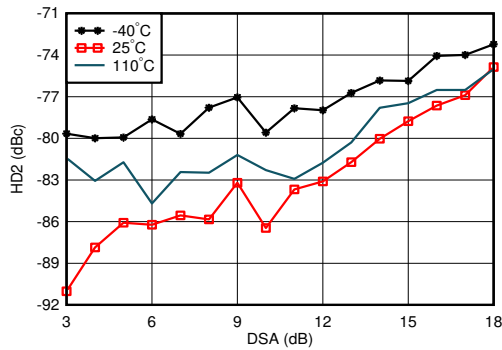

With 3.5GHz matching, DDC bypass mode (TI only mode for characterization)

4-380. RX HD2 vs DSA Setting and Temperature at 3.6GHz

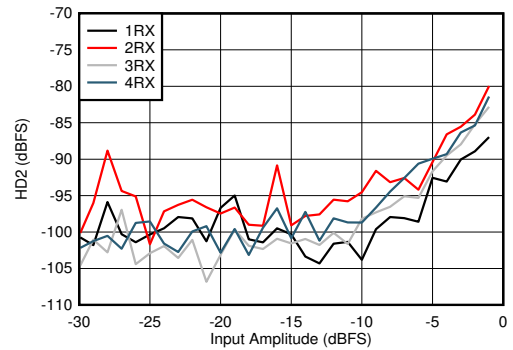

With 3.5GHz matching, DDC bypass mode (TI only mode for characterization)

4-381. RX HD2 vs Input Level and Channel at 3.6GHz

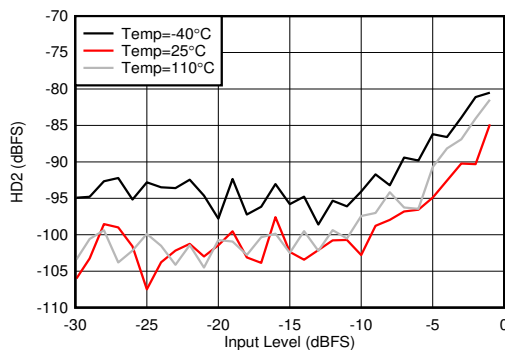

With 3.5GHz matching, DDC bypass mode (TI only mode for characterization)

4-382. RX HD2 vs Input Level and Temperature at 3.6GHz

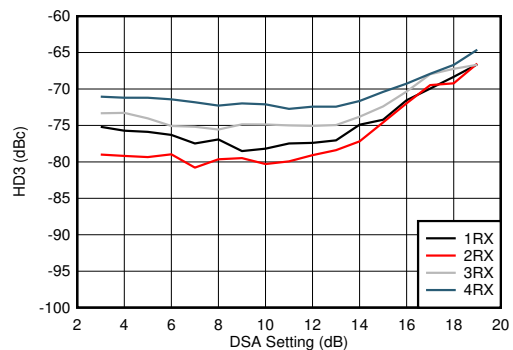

With 3.5GHz matching, DDC bypass mode (TI only mode for characterization)

4-383. RX HD3 vs DSA Setting and Channel at 3.6GHz

4.12.11 RX Typical Characteristics at 3.5GHz (continued)

Typical values at $T_A = +25^\circ\text{C}$, ADC Sampling Rate = 2949.12MHz. Default conditions: output sample rate = 491.52MSPS (decimate by 6), PLL clock mode with $f_{REF} = 491.52\text{MHz}$, $A_{IN} = -3\text{dBFS}$, DSA setting = 4dB.

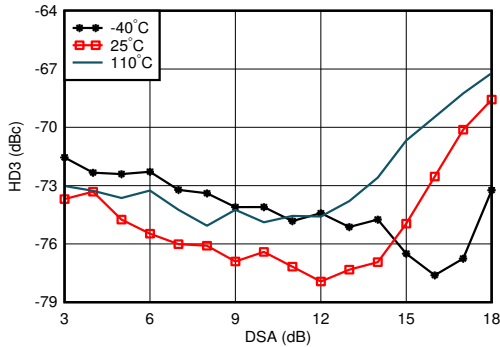

With 3.5GHz matching, DDC bypass mode (TI only mode for characterization)

4-384. RX HD3 vs DSA Setting and Temperature at 3.6GHz

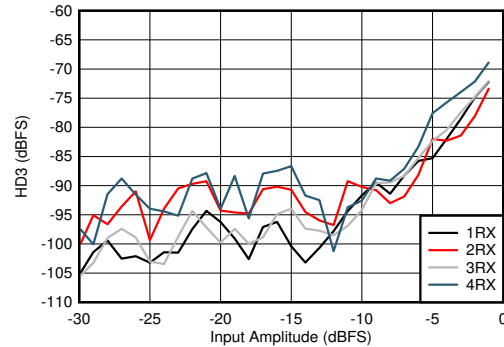

With 3.5GHz matching, DDC bypass mode (TI only mode for characterization)

4-385. RX HD3 vs Input Level and Channel at 3.6GHz

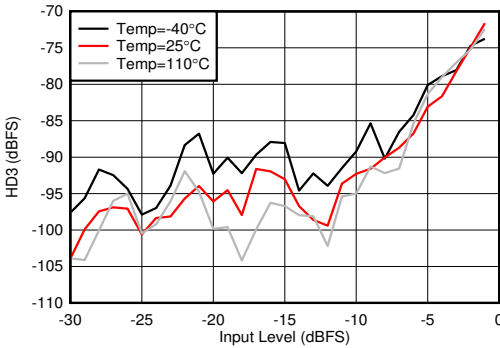

With 3.5GHz matching, DDC bypass mode (TI only mode for characterization)

4-386. RX HD3 vs Input Level and Temperature at 3.6GHz

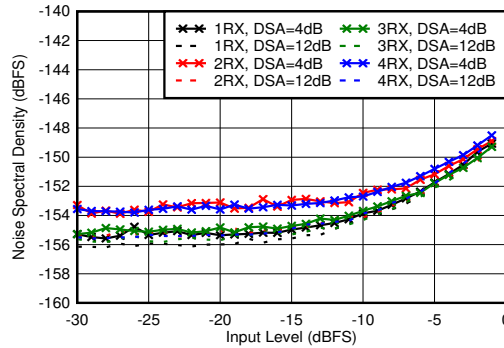

With 3.5GHz matching, 12.5-MHz offset from tone

4-387. RX Noise Spectral Density vs Input Level and DSA Setting at 3.6GHz

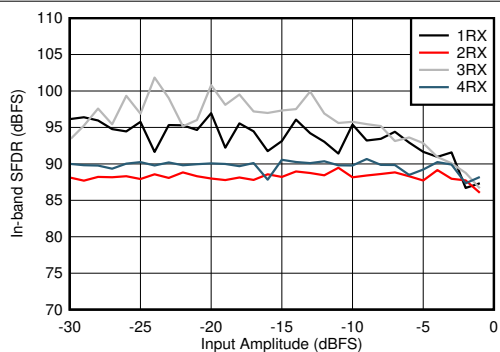

With 3.5GHz matching

4-388. RX In-Band SFDR ($\pm 200\text{MHz}$) vs Input Level and Channel at 3.6GHz

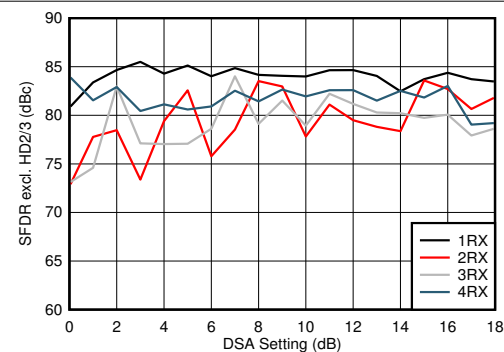

With 3.5GHz matching

4-389. RX SFDR Excluding HD2/3 vs DSA Setting and Channel at 3.6GHz

4.12.11 RX Typical Characteristics at 3.5GHz (continued)

Typical values at $T_A = +25^\circ\text{C}$, ADC Sampling Rate = 2949.12GHz. Default conditions: output sample rate = 491.52MSPS (decimate by 6), PLL clock mode with $f_{REF} = 491.52\text{MHz}$, $A_{IN} = -3\text{dBFS}$, DSA setting = 4dB.

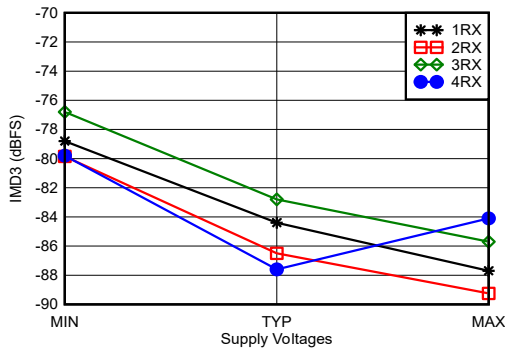

With 3.6GHz matching, -7dBFS each tone, 20MHz tone spacing, all supplies at MIN, TYP, or MAX recommended operating voltages

Figure 4-390. RX IMD3 vs Supply Voltage and Channel at 3.6GHz

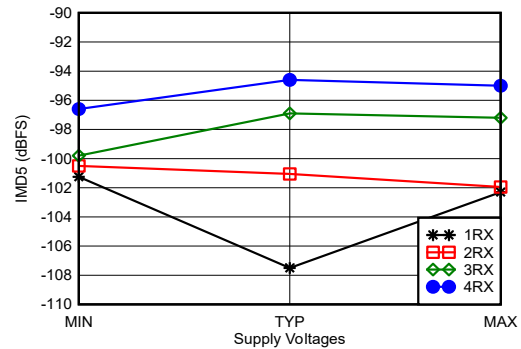

With 3.6GHz matching, -7dBFS each tone, 20-MHz tone spacing, all supplies at MIN, TYP, or MAX recommended operating voltages

Figure 4-391. RX IMD5 vs Supply Voltage and Channel at 3.6GHz

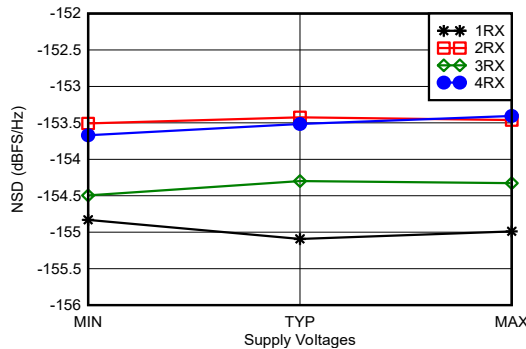

With 3.6GHz matching, tone at 20 dBFS, 12.5MHz offset frequency, all supplies at MIN, TYP, or MAX recommended operating voltages

Figure 4-392. RX Noise Spectral Density vs Supply Voltage and Channel at 3.6GHz

4.12.12 RX Typical Characteristics at 4.9GHz

Typical values at $T_A = +25^\circ\text{C}$, ADC Sampling Rate = 2949.12MHz. Default conditions: output sample rate = 491.52MSPS (decimate by 6), PLL clock mode with $f_{\text{REF}} = 491.52\text{MHz}$, $A_{\text{IN}} = -3\text{dBFS}$, DSA setting = 4dB.

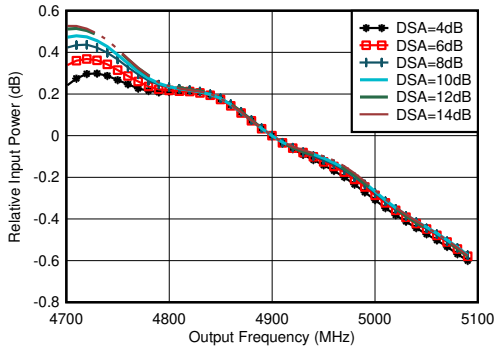

With matching, normalized to power at 4.9GHz for each DSA setting

FIG 4-393. RX Inband Gain Flatness, $f_{\text{IN}} = 4900\text{MHz}$

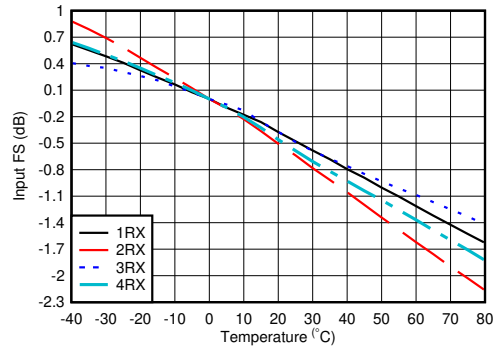

With 4.9GHz matching, normalized to fullscale at 25°C for each channel

FIG 4-394. RX Input Fullscale vs Temperature and Channel at 4.9GHz

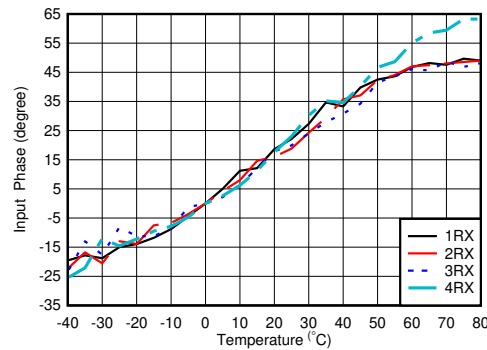

With 4.9GHz matching, normalized to phase at 25°C

FIG 4-395. RX Input Phase vs Temperature and DSA at $f_{\text{OUT}} = 4.9\text{GHz}$

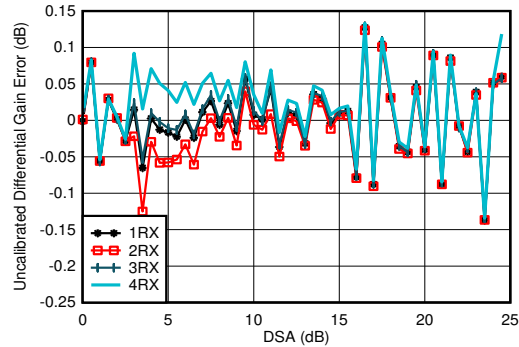

With 4.9GHz matching

$$\text{Differential Amplitude Error} = P_{\text{IN}}(\text{DSA Setting} - 1) - P_{\text{IN}}(\text{DSA Setting}) + 1$$

FIG 4-396. RX Uncalibrated Differential Amplitude Error vs DSA Setting at 4.9GHz

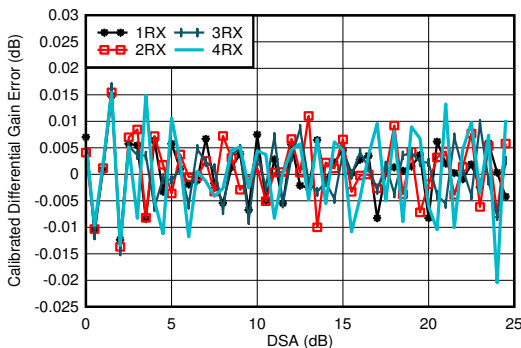

With 4.9GHz matching

$$\text{Differential Amplitude Error} = P_{\text{IN}}(\text{DSA Setting} - 1) - P_{\text{IN}}(\text{DSA Setting}) + 1$$

FIG 4-397. RX Calibrated Differential Amplitude Error vs DSA Setting at 4.9GHz

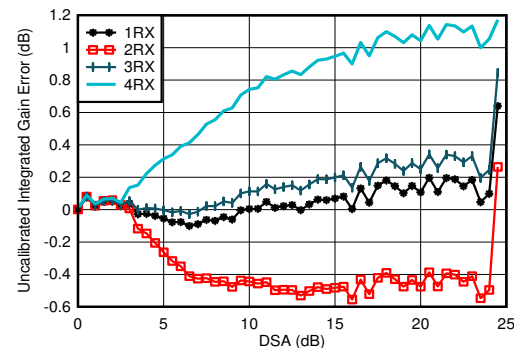

With 4.9GHz matching

$$\text{Integrated Amplitude Error} = P_{\text{IN}}(\text{DSA Setting}) - P_{\text{IN}}(\text{DSA Setting} = 0) + (\text{DSA Setting})$$

FIG 4-398. RX Uncalibrated Integrated Amplitude Error vs DSA Setting at 4.9GHz

4.12.12 RX Typical Characteristics at 4.9GHz (continued)

Typical values at $T_A = +25^\circ\text{C}$, ADC Sampling Rate = 2949.12GHz. Default conditions: output sample rate = 491.52MSPS (decimate by 6), PLL clock mode with $f_{\text{REF}} = 491.52\text{MHz}$, $A_{\text{IN}} = -3\text{dBFS}$, DSA setting = 4dB.

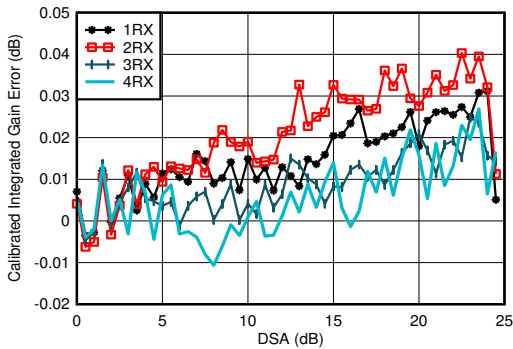

With 4.9GHz matching
Integrated Amplitude Error = $P_{\text{IN}}(\text{DSA Setting}) - P_{\text{IN}}(\text{DSA Setting} = 0) + (\text{DSA Setting})$

4-399. RX Calibrated Integrated Amplitude Error vs DSA Setting at 4.9GHz

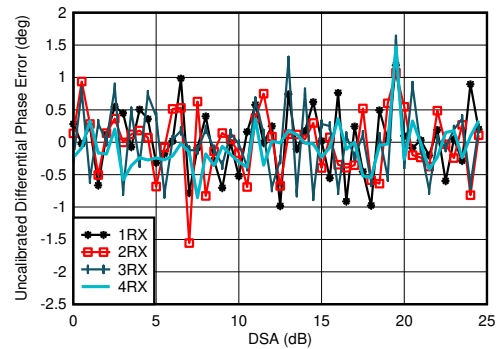

With 4.9GHz matching
Differential Phase Error = $\text{Phase}_{\text{IN}}(\text{DSA Setting} - 1) - \text{Phase}_{\text{IN}}(\text{DSA Setting})$

4-400. RX Uncalibrated Differential Phase Error vs DSA Setting at 4.9GHz

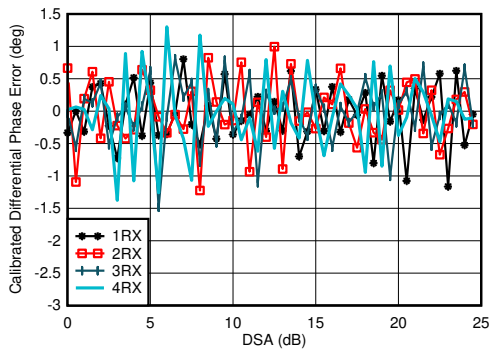

With 4.9GHz matching
Differential Phase Error = $\text{Phase}_{\text{IN}}(\text{DSA Setting} - 1) - \text{Phase}_{\text{IN}}(\text{DSA Setting})$

4-401. RX Calibrated Differential Phase Error vs DSA Setting at 4.9GHz

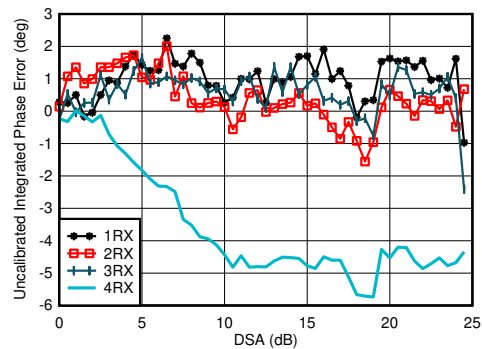

With 4.9GHz matching
Integrated Phase Error = $\text{Phase}(\text{DSA Setting}) - \text{Phase}(\text{DSA Setting} = 0)$

4-402. RX Uncalibrated Integrated Phase Error vs DSA Setting at 4.9GHz

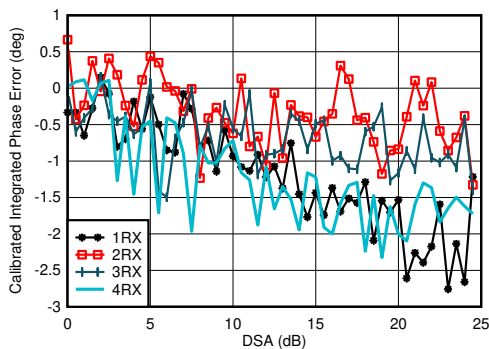

With 4.9GHz matching
Integrated Phase Error = $\text{Phase}(\text{DSA Setting}) - \text{Phase}(\text{DSA Setting} = 0)$

4-403. RX Calibrated Integrated Phase Error vs DSA Setting at 4.9GHz

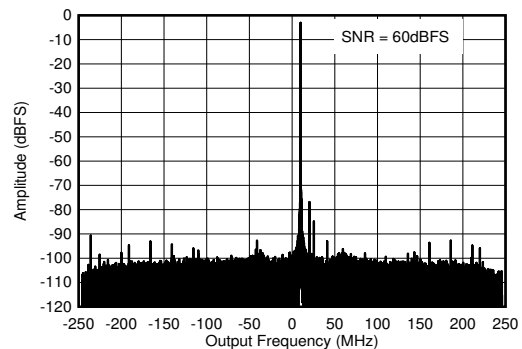

With 4.9GHz matching, $f_{\text{IN}} = 4910\text{MHz}$, $A_{\text{IN}} = -3\text{dBFS}$

4-404. RX Output FFT at 4.9GHz

4.12.12 RX Typical Characteristics at 4.9GHz (continued)

Typical values at $T_A = +25^\circ\text{C}$, ADC Sampling Rate = 2949.12MHz. Default conditions: output sample rate = 491.52MSPS (decimate by 6), PLL clock mode with $f_{REF} = 491.52\text{MHz}$, $A_{IN} = -3\text{dBFS}$, DSA setting = 4dB.

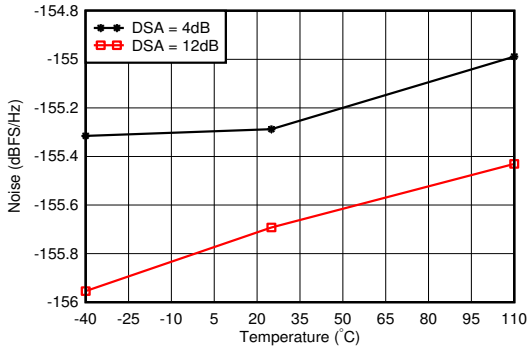

With 4.9GHz matching, 12.5-MHz offset from tone

4-405. RX Noise Spectral Density vs Temperature at 4.9GHz

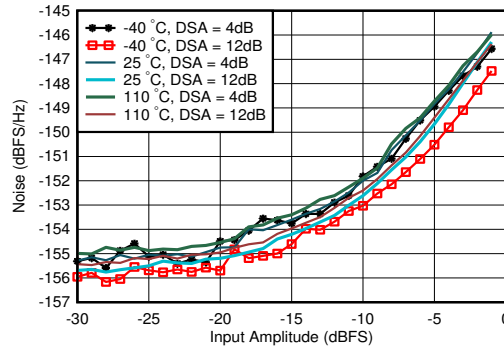

With 4.9GHz matching, DSA Setting = 12dB, 12.5MHz offset from tone

4-406. RX Noise Spectral Density vs Input Amplitude and Temperature at 4.9GHz

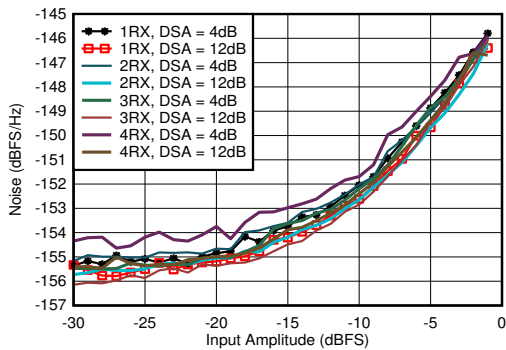

With 4.9GHz matching, 12.5MHz offset from tone

4-407. RX Noise Spectral Density vs Input Amplitude and Channel at 4.9GHz

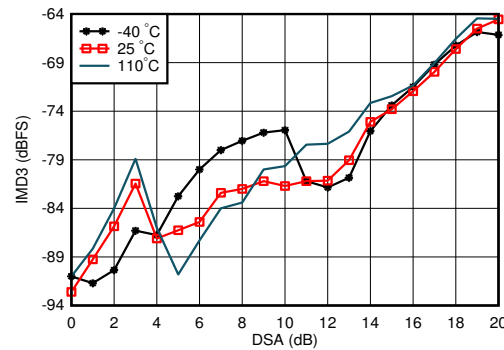

With 4.9GHz matching, each tone -7dBFS , tone spacing = 20MHz

4-408. RX IMD3 vs DSA Setting and Temperature at 4.9GHz

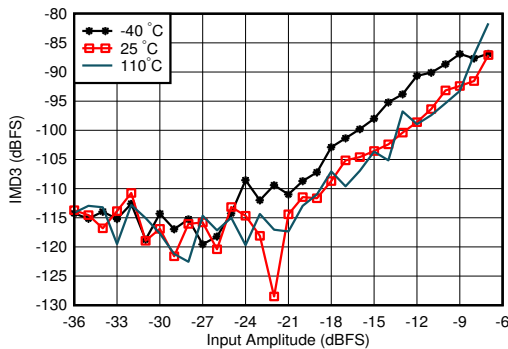

With 4.9GHz matching, tone spacing = 20MHz, DSA = 4dB

4-409. RX IMD3 vs Input Level and Temperature at 4.9GHz

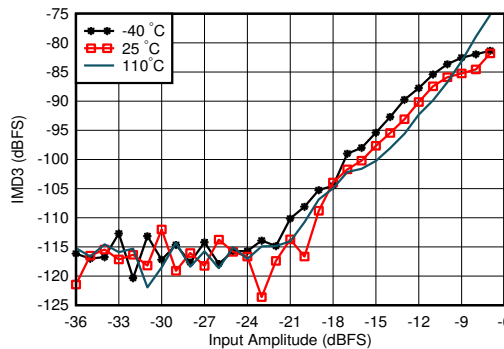

With 4.9GHz matching, tone spacing = 20MHz, DSA = 12dB

4-410. RX IMD3 vs Input Level and Temperature at 4.9GHz

4.12.12 RX Typical Characteristics at 4.9GHz (continued)

Typical values at $T_A = +25^\circ\text{C}$, ADC Sampling Rate = 2949.12GHz. Default conditions: output sample rate = 491.52MSPS (decimate by 6), PLL clock mode with $f_{REF} = 491.52\text{MHz}$, $A_{IN} = -3\text{dBFS}$, DSA setting = 4dB.

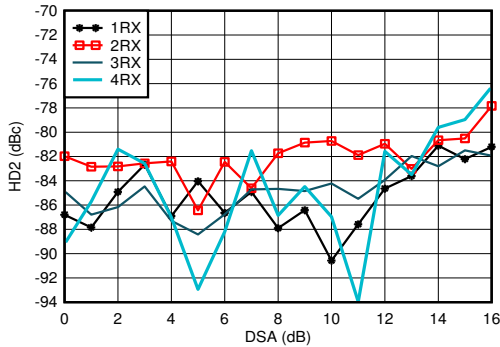

With 4.9GHz matching, measured after HD2 trim, DDC bypass mode (TI only mode for characterization)

4-411. RX HD2 vs DSA Setting and Channel at 4.9GHz

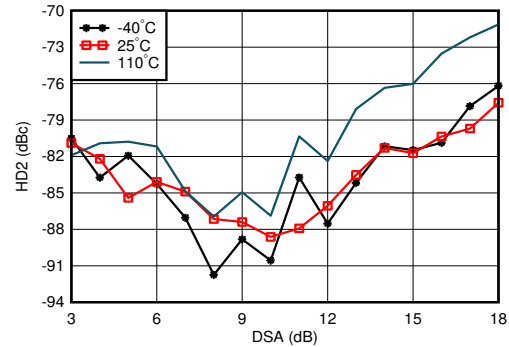

With 4.9GHz matching, measured after HD2 trim, DDC bypass mode (TI only mode for characterization)

4-412. RX HD2 vs DSA and Temperature at 4.9GHz

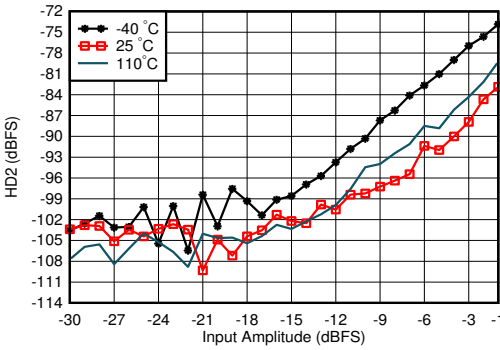

With 4.9GHz matching, measured after HD2 trim, DDC bypass mode (TI only mode for characterization)

4-413. RX HD2 vs Input Level and Temperature at 4.9GHz

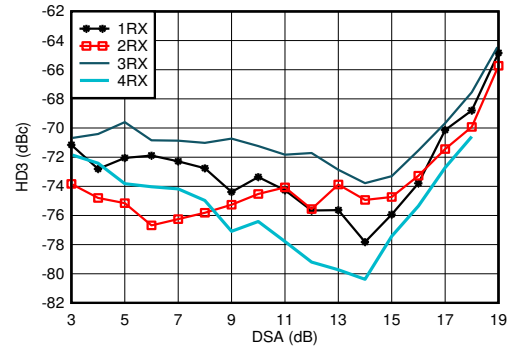

With 4.9GHz matching, DDC bypass mode (TI only mode for characterization)

4-414. RX HD3 vs DSA Setting and Channel at 4.9GHz

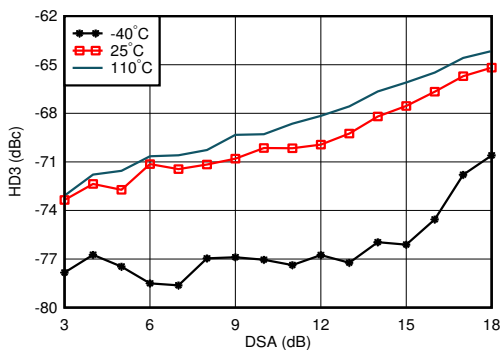

With 4.9GHz matching, DDC bypass mode (TI only mode for characterization)

4-415. RX HD3 vs DSA Setting and Temperature at 4.9GHz

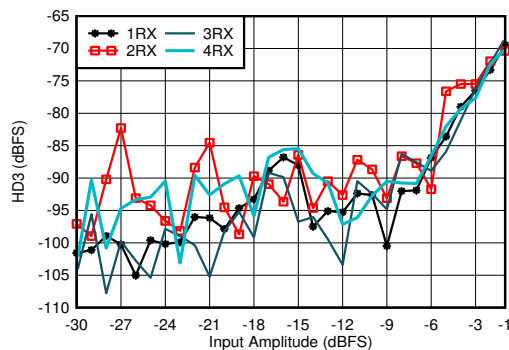

With 4.9GHz matching, DDC bypass mode (TI only mode for characterization)

4-416. RX HD3 vs Input Level and Channel at 4.9GHz

4.12.12 RX Typical Characteristics at 4.9GHz (continued)

Typical values at $T_A = +25^\circ\text{C}$, ADC Sampling Rate = 2949.12GHz. Default conditions: output sample rate = 491.52MSPS (decimate by 6), PLL clock mode with $f_{REF} = 491.52\text{MHz}$, $A_{IN} = -3\text{dBFS}$, DSA setting = 4dB.

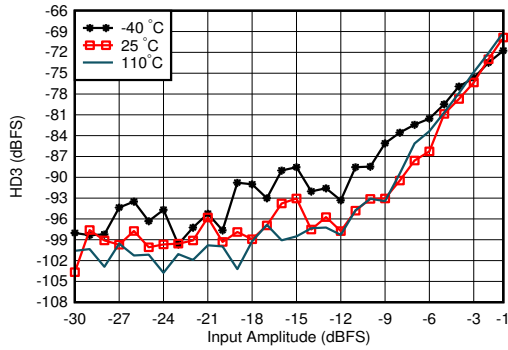

With 4.9GHz matching, DDC bypass mode (TI only mode for characterization)

4-417. RX HD3 vs Input Level and Temperature at 4.9GHz

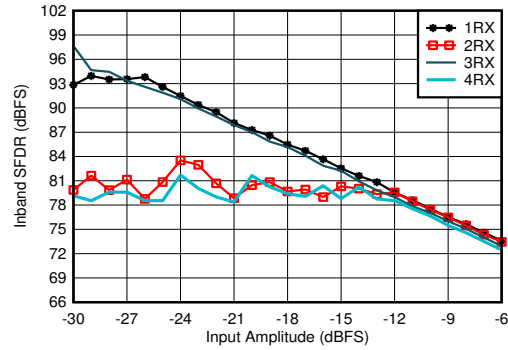

With 4.9GHz matching, decimate by 3

4-418. RX In-Band SFDR (± 400 MHz) vs Input Amplitude and Channel at 4.9GHz

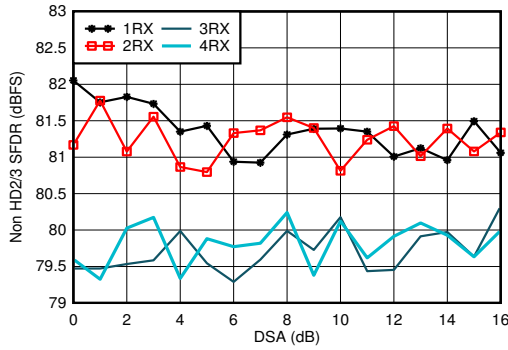

With 4.9GHz matching

4-419. RX Non-HD2/3 vs DSA Setting at 4.9GHz

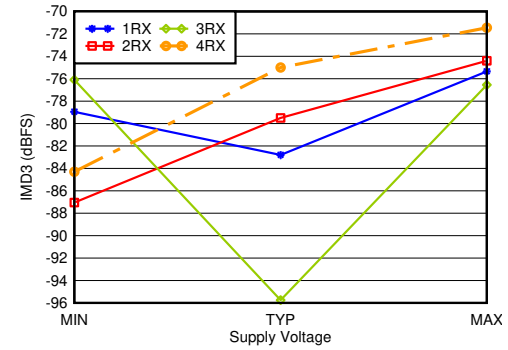

With 4.9GHz matching, -7dBFS each tone, 20MHz tone spacing, all supplies at MIN, TYP, or MAX recommended operating voltages

4-420. RX IMD3 vs Supply and Channel at 4.9GHz

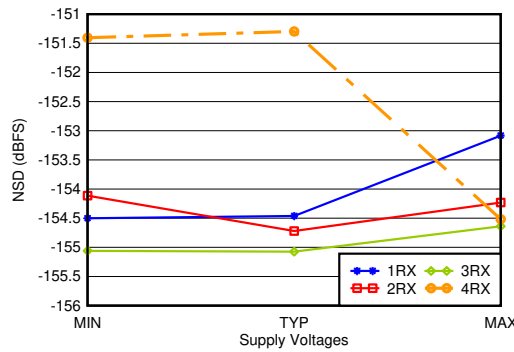

With 4.9GHz matching, 12.5MHz offset, all supplies at MIN, TYP, or MAX recommended operating voltages

4-421. RX Noise Spectral Density vs Supply and Channel at 4.9GHz

4.12.13 RX Typical Characteristics at 8.1GHz

Typical values at $T_A = +25^\circ\text{C}$, ADC Sampling Rate = 2949.12MHz. Default conditions: output sample rate = 1474.56MSPS (decimate by 2), External clock mode with $f_{\text{CLK}} = 11796.48\text{MHz}$, $A_{\text{IN}} = -3\text{dBFS}$, DSA setting = 3 dB, 8.1GHz matching.

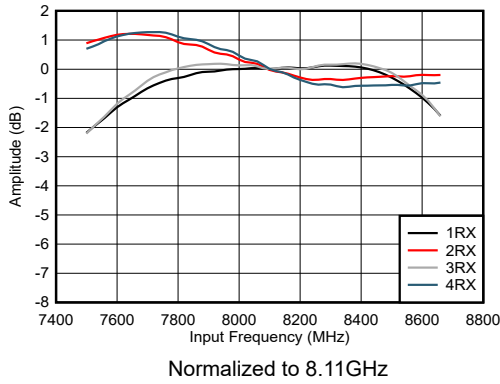

4-422. RX Amplitude vs Frequency and Channel

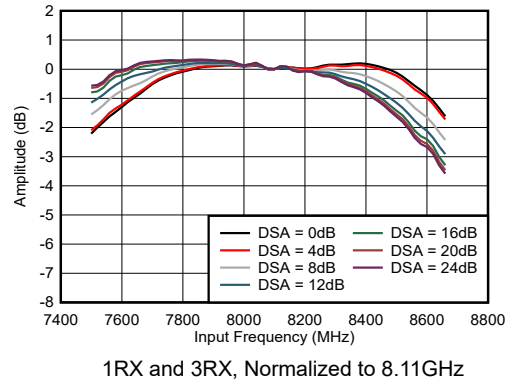

4-423. RX Amplitude vs Frequency and DSA Setting

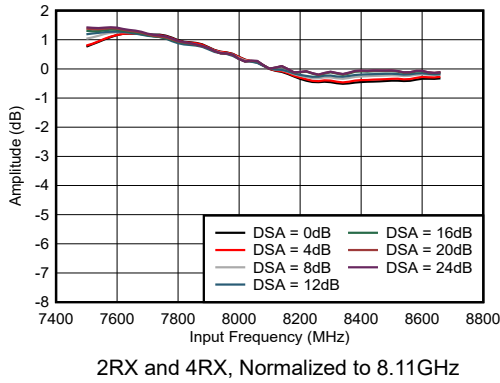

4-424. RX Amplitude vs Frequency and DSA Setting

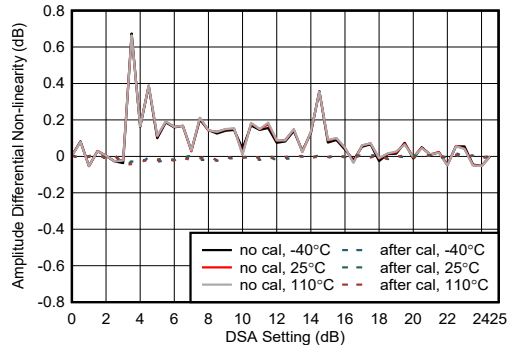

4-425. RX Amplitude Differential Nonlinearity at 8.11GHz

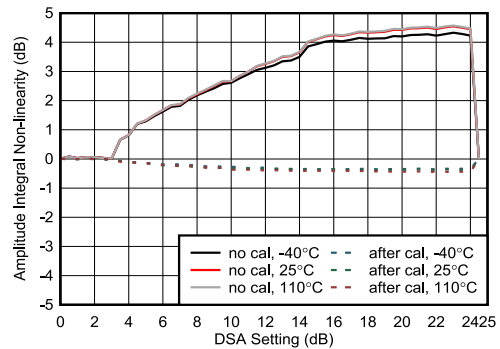

4-426. RX Amplitude Integrated Nonlinearity at 8.11GHz

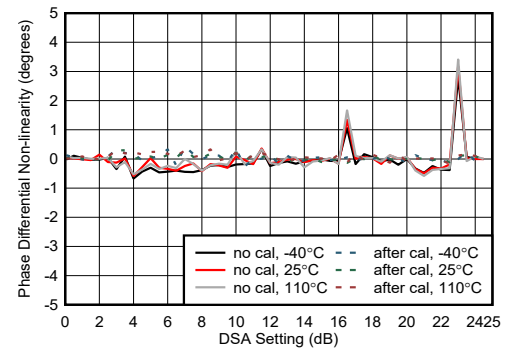

4-427. RX Phase Differential Nonlinearity at 8.11GHz

4.12.13 RX Typical Characteristics at 8.1GHz (continued)

Typical values at $T_A = +25^\circ\text{C}$, ADC Sampling Rate = 2949.12MHz. Default conditions: output sample rate = 1474.56MSPS (decimate by 2), External clock mode with $f_{\text{CLK}} = 11796.48\text{MHz}$, $A_{\text{IN}} = -3\text{dBFS}$, DSA setting = 3 dB, 8.1GHz matching.

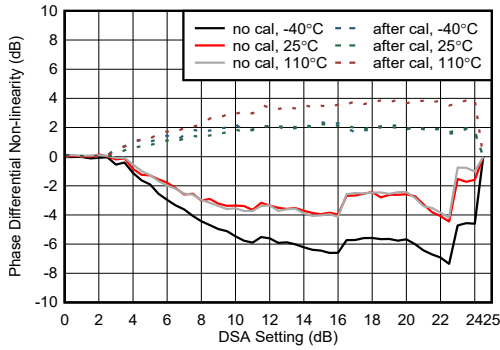

4-428. RX Phase Differential Nonlinearity at 8.1GHz

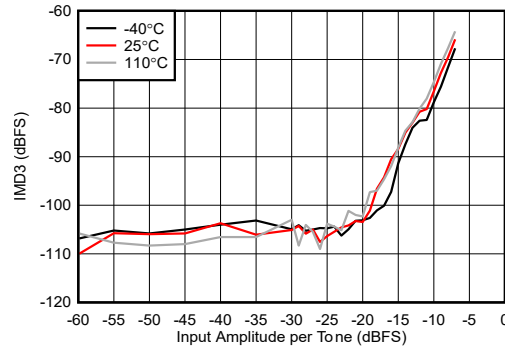

4-429. RX IMD3 vs Input Amplitude at 8.1GHz

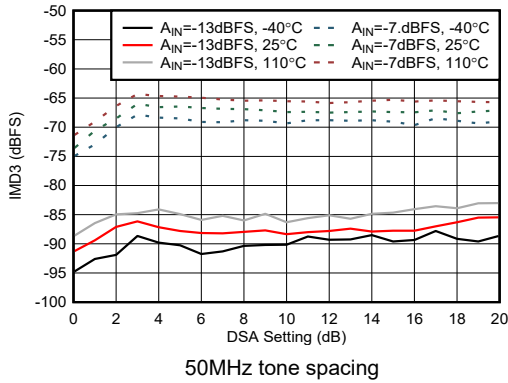

4-430. RX IMD3 vs DSA Setting at 8.1GHz

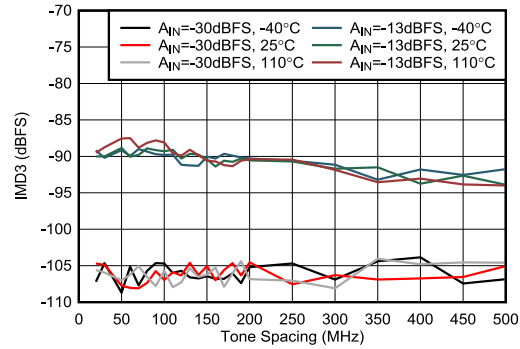

4-431. RX IMD3 vs Tone Spacing at 8.1GHz

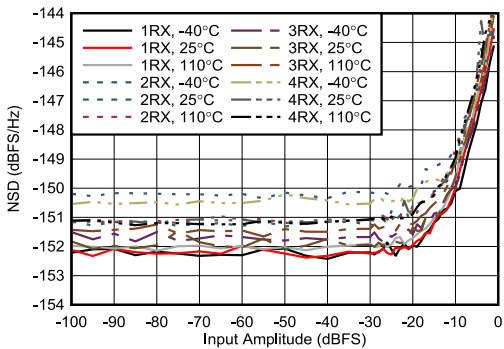

4-432. RX NSD vs Digital Amplitude at 8.1GHz

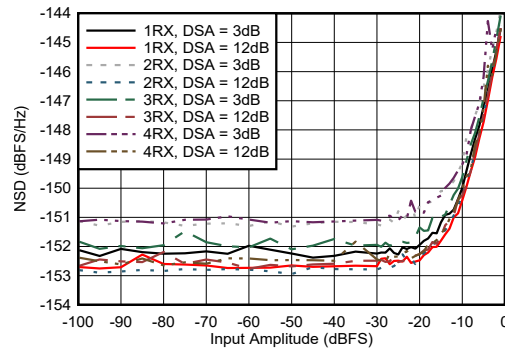

4-433. RX NSD vs Digital Amplitude at 8.1GHz

4.12.13 RX Typical Characteristics at 8.1GHz (continued)

Typical values at $T_A = +25^\circ\text{C}$, ADC Sampling Rate = 2949.12MHz. Default conditions: output sample rate = 1474.56MSPS (decimate by 2), External clock mode with $f_{\text{CLK}} = 11796.48\text{MHz}$, $A_{\text{IN}} = -3\text{dBFS}$, DSA setting = 3 dB, 8.1GHz matching.

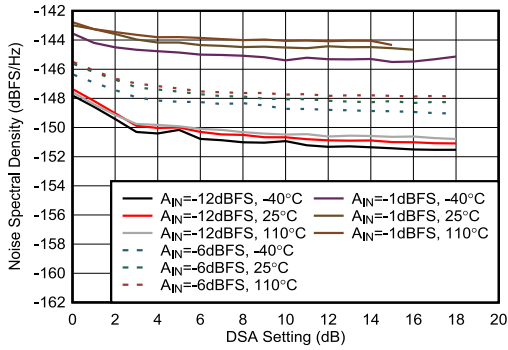

4-434. RX NSD vs DSA Setting at 8.1GHz

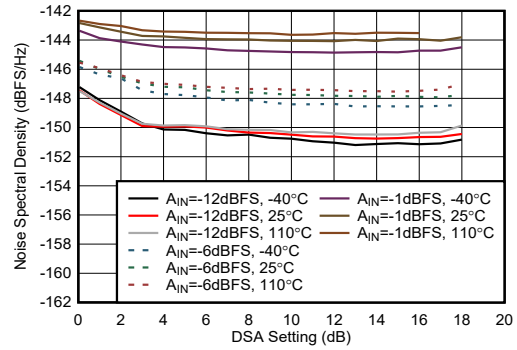

External clock mode

4-435. RX NSD vs DSA Setting at 8.1GHz

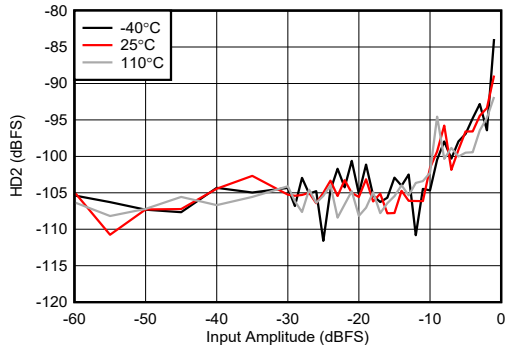

4-436. RX HD2 vs Digital Amplitude at 8.1GHz

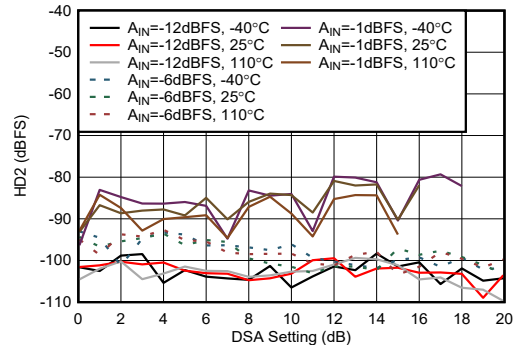

4-437. RX HD2 vs DSA Setting at 8.1GHz

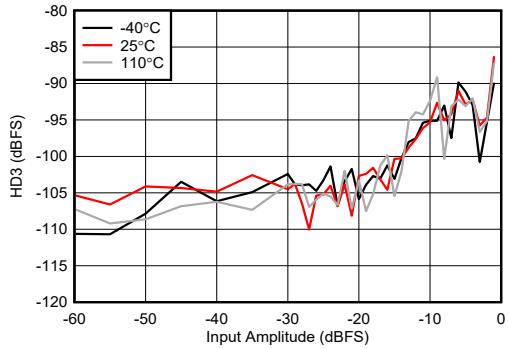

4-438. RX HD3 vs Digital Amplitude at 8.1GHz

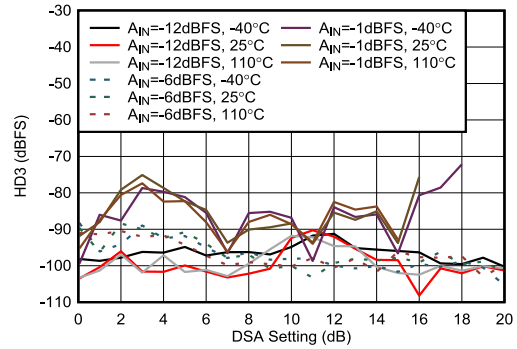

4-439. RX HD3 vs DSA Setting at 8.1GHz

4.12.13 RX Typical Characteristics at 8.1GHz (continued)

Typical values at $T_A = +25^\circ\text{C}$, ADC Sampling Rate = 2949.12MHz. Default conditions: output sample rate = 1474.56MSPS (decimate by 2), External clock mode with $f_{\text{CLK}} = 11796.48\text{MHz}$, $A_{\text{IN}} = -3\text{dBFS}$, DSA setting = 3 dB, 8.1GHz matching.



图 4-440. RX 2-tone SFDR vs Digital Amplitude at 8.11GHz



图 4-441. RX Single Tone Output FFT at 8.11GHz, -1dBFS

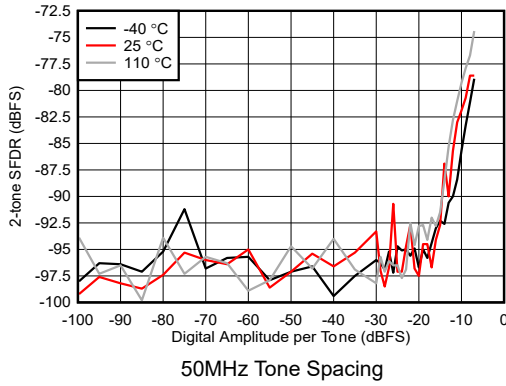

图 4-442. RX Single Tone Output FFT at 8.11GHz, -12dBFS

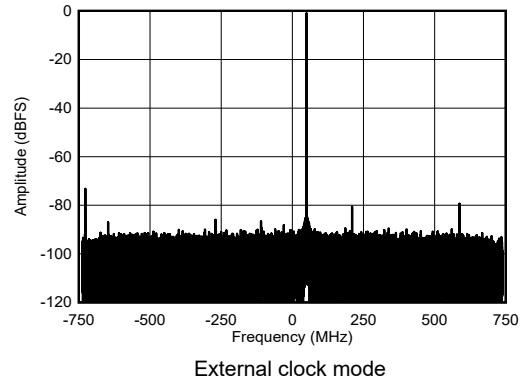

图 4-443. RX Single Tone Output FFT at 8.11GHz, -30 dBFS

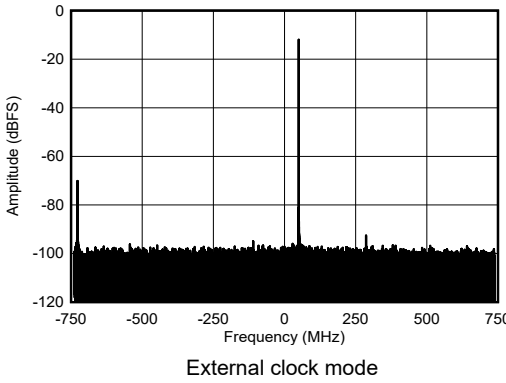

图 4-444. RX Single Tone Output FFT at 8.11GHz, -60 dBFS

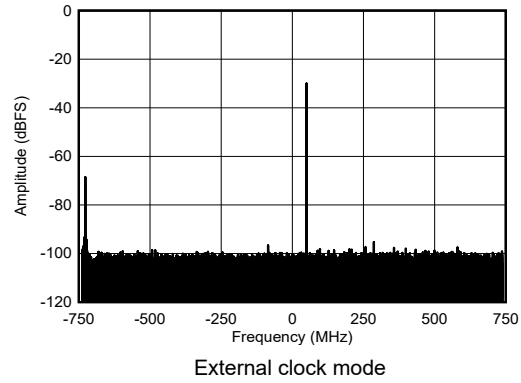

图 4-445. RX Dual Tone Output FFT at 8.11GHz

4.12.13 RX Typical Characteristics at 8.1GHz (continued)

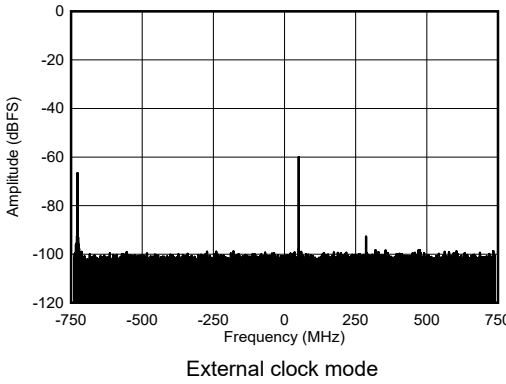
Typical values at $T_A = +25^\circ\text{C}$, ADC Sampling Rate = 2949.12MHz. Default conditions: output sample rate = 1474.56MSPS (decimate by 2), External clock mode with $f_{\text{CLK}} = 11796.48\text{MHz}$, $A_{\text{IN}} = -3\text{dBFS}$, DSA setting = 3 dB, 8.1GHz matching.

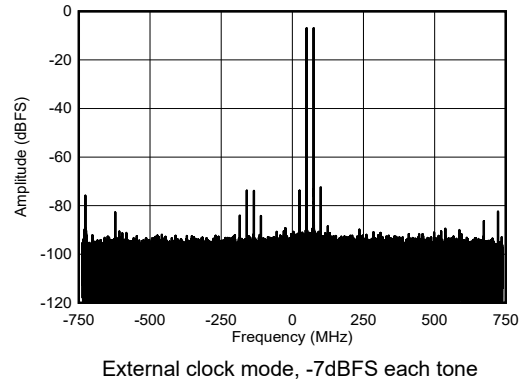
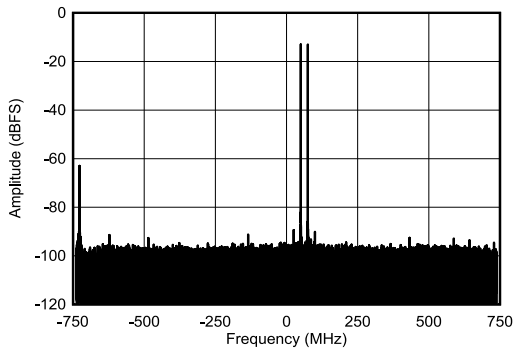

External clock mode, -13dBFS each tone

Figure 4-446. RX Dual Tone Output FFT at 8.1GHz

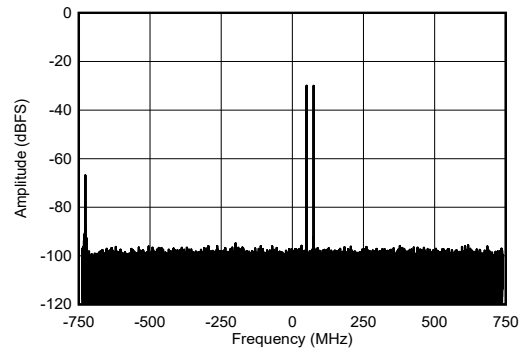

External clock mode, -30dBFS each tone

Figure 4-447. RX Dual Tone Output FFT at 8.1GHz

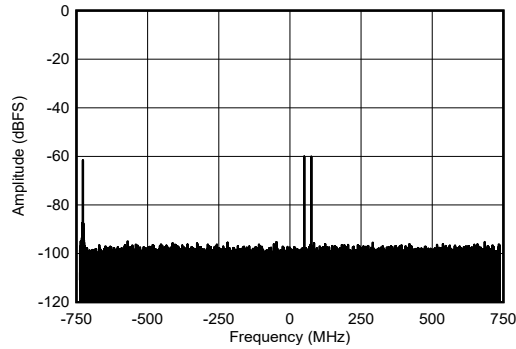

External clock mode, -60dBFS each tone

Figure 4-448. RX Dual Tone Output FFT at 8.1GHz

4.12.14 RX Typical Characteristics at 9.6GHz

Typical values at $T_A = +25^\circ\text{C}$, ADC Sampling Rate = 2949.12MHz. Default conditions: output sample rate = 1474.56MSPS (decimate by 2), External clock mode with $f_{\text{CLK}} = 11796.48\text{MHz}$, $A_{\text{IN}} = -3\text{dBFS}$, DSA setting = 3 dB, 9.6GHz matching.

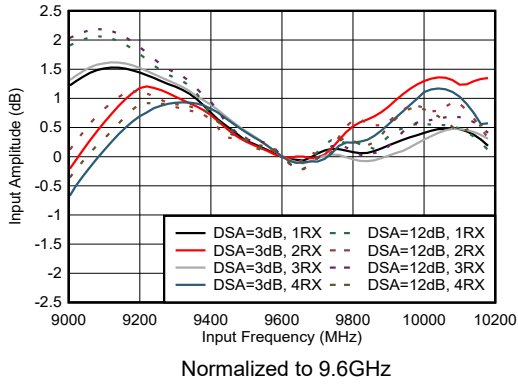

4-449. RX Input Amplitude vs Frequency

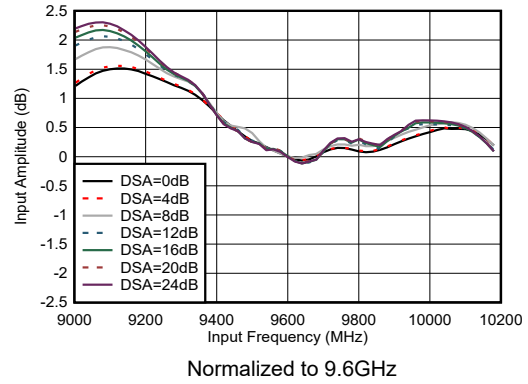

4-450. RX Input Amplitude vs Frequency at 9.6GHz

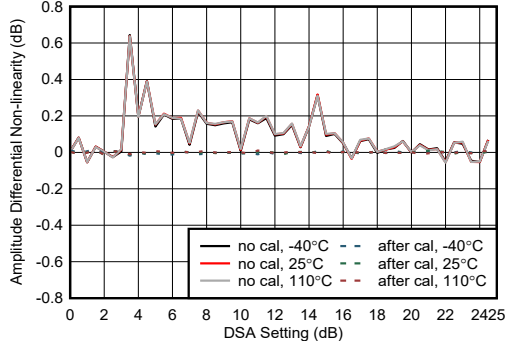

4-451. RX Amplitude Differential Non-linearity at 9.6GHz

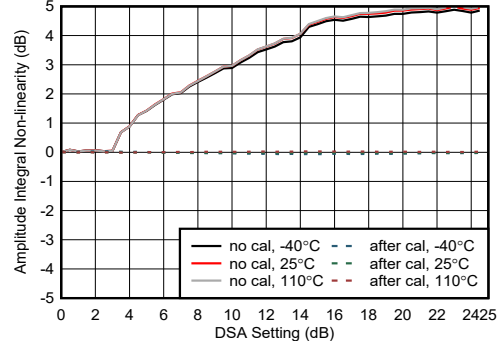

4-452. RX Amplitude Integrated Non-linearity at 9.6GHz

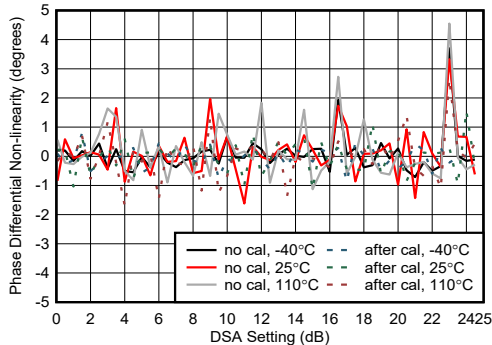

4-453. RX Phase Differential Non-linearity at 9.6GHz

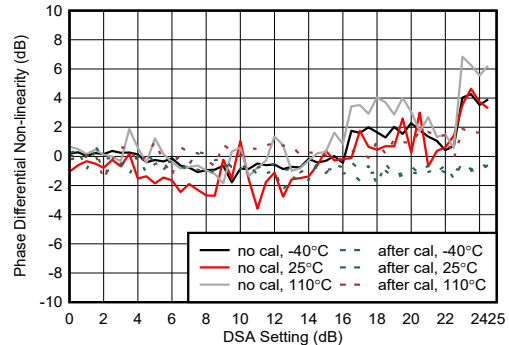

4-454. RX Phase Integrated Non-linearity at 9.6GHz

4.12.14 RX Typical Characteristics at 9.6GHz (continued)

Typical values at $T_A = +25^\circ\text{C}$, ADC Sampling Rate = 2949.12MHz. Default conditions: output sample rate = 1474.56MSPS (decimate by 2), External clock mode with $f_{\text{CLK}} = 11796.48\text{MHz}$, $A_{\text{IN}} = -3\text{dBFS}$, DSA setting = 3 dB, 9.6GHz matching.

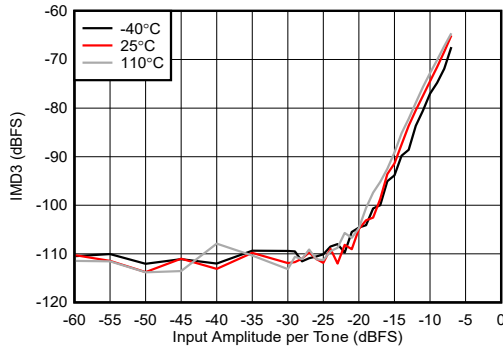

Figure 4-455. RX IMD3 vs Digital Amplitude at 9.6GHz

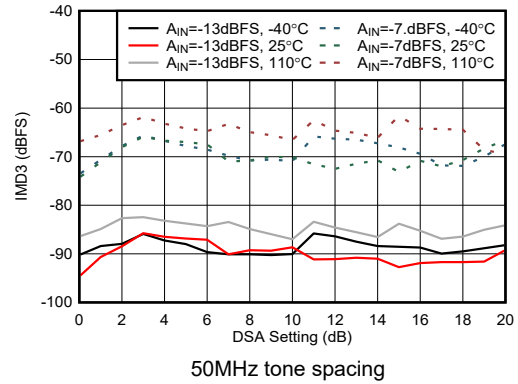

Figure 4-456. RX IMD3 vs DSA Setting at 9.6GHz

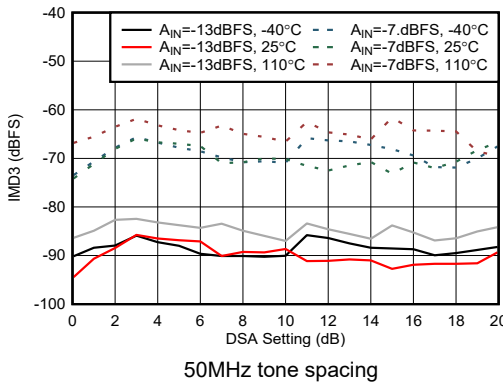

Figure 4-457. RX IMD3 vs DSA Setting at 9.6GHz

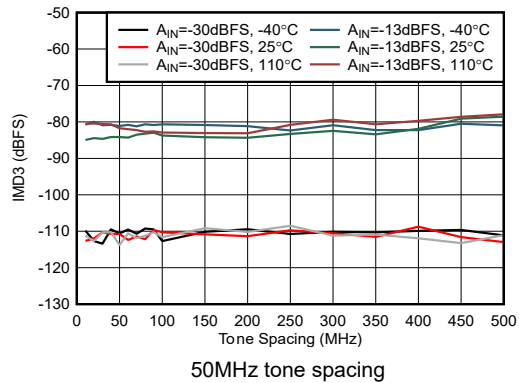

Figure 4-458. RX IMD3 vs Tone Spacing at 9.6GHz

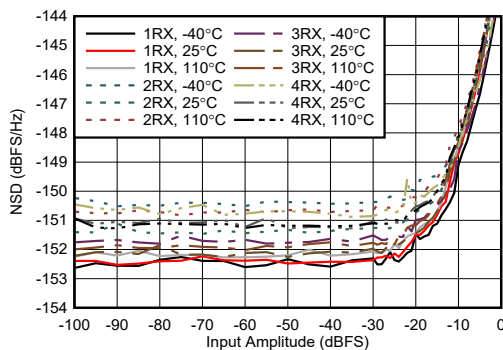

Figure 4-459. RX NSD vs Digital Amplitude at 9.6GHz

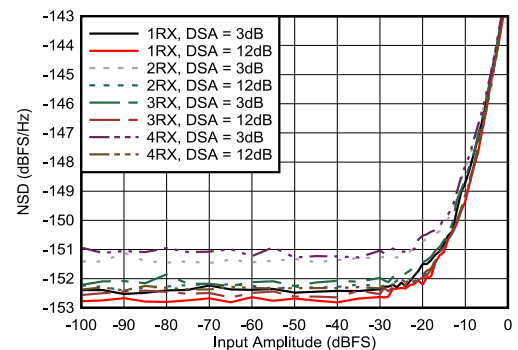
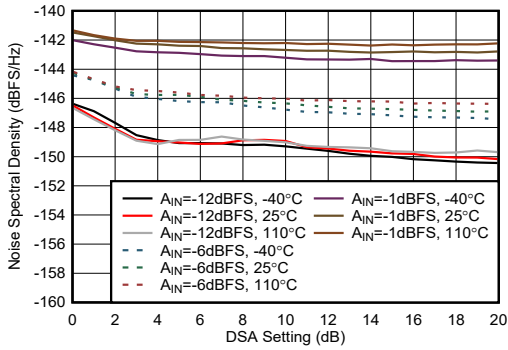

Figure 4-460. RX NSD vs Digital Amplitude at 9.6GHz

4.12.14 RX Typical Characteristics at 9.6GHz (continued)

Typical values at $T_A = +25^\circ\text{C}$, ADC Sampling Rate = 2949.12MHz. Default conditions: output sample rate = 1474.56MSPS (decimate by 2), External clock mode with $f_{\text{CLK}} = 11796.48\text{MHz}$, $A_{\text{IN}} = -3\text{dBFS}$, DSA setting = 3 dB, 9.6GHz matching.



4-461. RX NSD vs DSA Setting at 9.6GHz

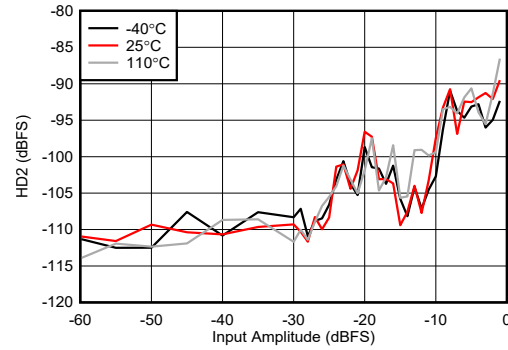

4-462. RX HD2 vs Digital Level at 9.6GHz

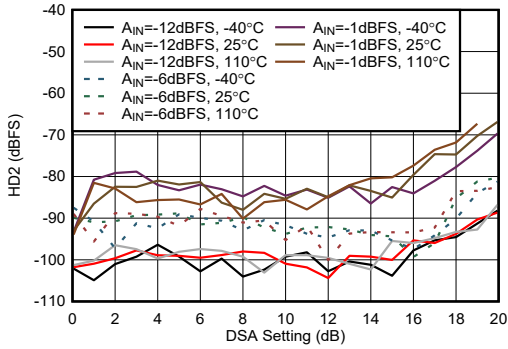

4-463. RX HD2 vs DSA Setting at 9.6GHz

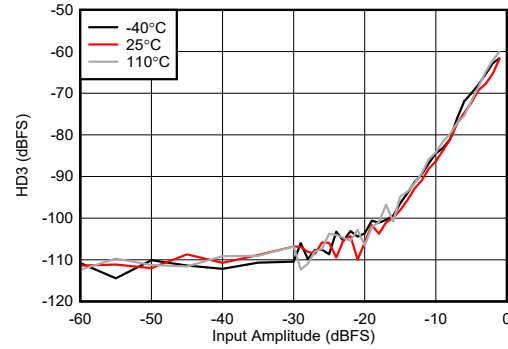

4-464. RX HD3 vs Digital Level at 9.6GHz

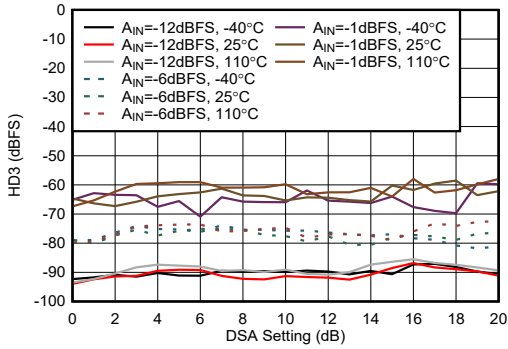

4-465. RX HD3 vs DSA Setting at 9.6GHz

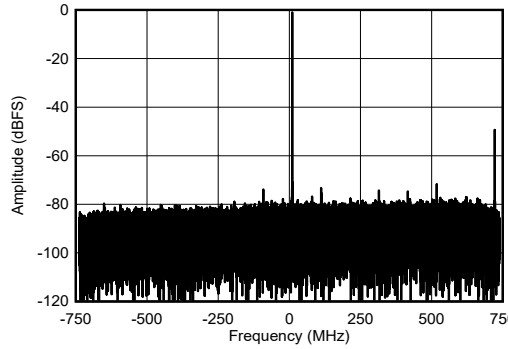

-1dBFS

4-466. RX Single Tone Output FFT at 9.61 GHz

4.12.14 RX Typical Characteristics at 9.6GHz (continued)

Typical values at $T_A = +25^\circ\text{C}$, ADC Sampling Rate = 2949.12MHz. Default conditions: output sample rate = 1474.56MSPS (decimate by 2), External clock mode with $f_{\text{CLK}} = 11796.48\text{MHz}$, $A_{\text{IN}} = -3\text{dBFS}$, DSA setting = 3 dB, 9.6GHz matching.

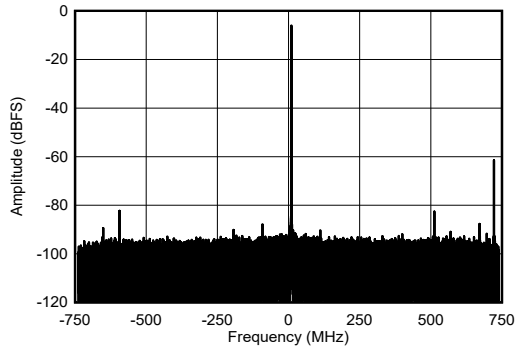

-6dBFS

图 4-467. RX Single Tone Output FFT at 9.61GHz

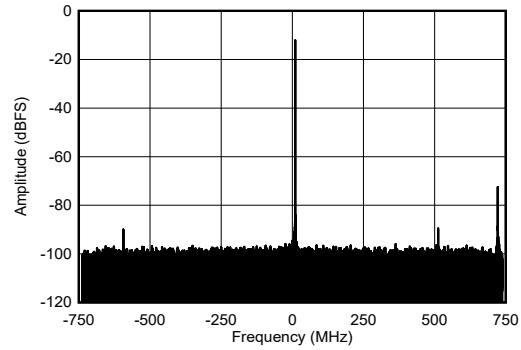

-12 dBFS.

图 4-468. RX Single Tone Output FFT at 9.61GHz

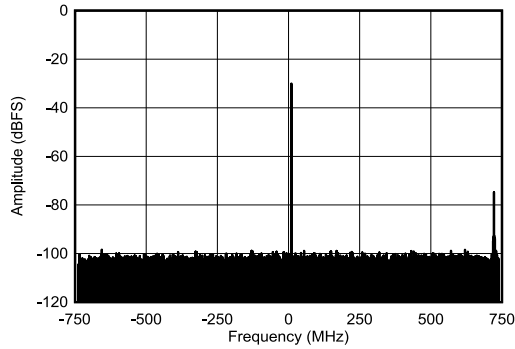

-30dBFS

图 4-469. RX Single Tone Output FFT at 9.61GHz

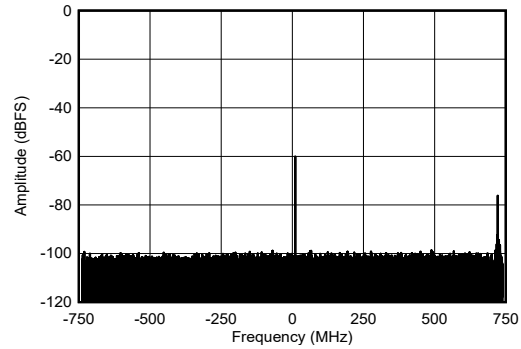

-60 dBFS

图 4-470. RX Single Tone Output FFT at 9.61GHz

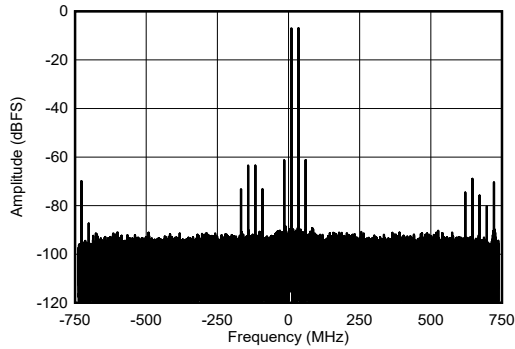

9.61 and 9.635GHz, -7dBFS each tone

图 4-471. RX Two Tone Output FFT at 9.61GHz

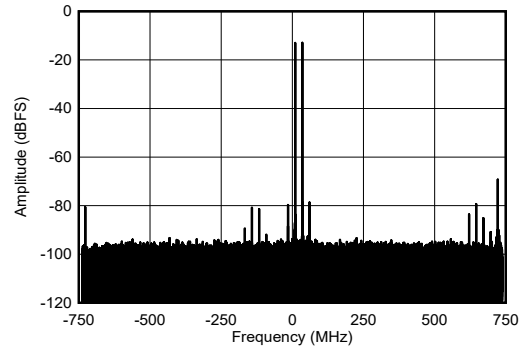

9.61 and 9.635GHz, -13dBFS each tone

图 4-472. RX Two Tone Output FFT at 9.61GHz

4.12.14 RX Typical Characteristics at 9.6GHz (continued)

Typical values at $T_A = +25^\circ\text{C}$, ADC Sampling Rate = 2949.12MHz. Default conditions: output sample rate = 1474.56MSPS (decimate by 2), External clock mode with $f_{\text{CLK}} = 11796.48\text{MHz}$, $A_{\text{IN}} = -3\text{dBFS}$, DSA setting = 3 dB, 9.6GHz matching.

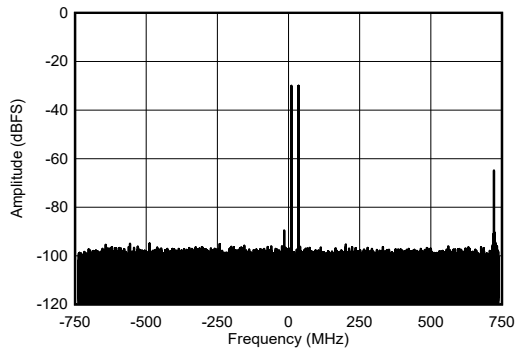

9.61 and 9.635GHz, -30dBFS each tone

图 4-473. RX Two Tone Output FFT at 9.61GHz

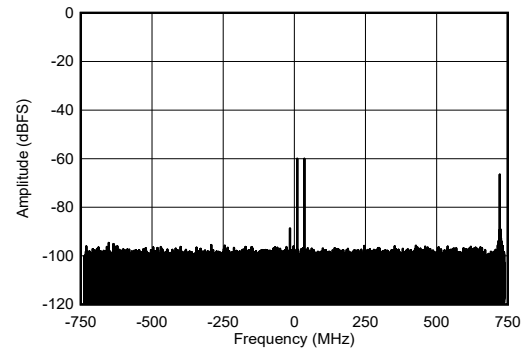

9.61 and 9.635GHz, -60dBFS each tone

图 4-474. RX Two Tone Output FFT at 9.61GHz

5 Device and Documentation Support

5.1 ドキュメントの更新通知を受け取る方法

ドキュメントの更新についての通知を受け取るには、www.tij.co.jp のデバイス製品フォルダを開いてください。[通知] をクリックして登録すると、変更されたすべての製品情報に関するダイジェストを毎週受け取ることができます。変更の詳細については、改訂されたドキュメントに含まれている改訂履歴をご覧ください。

5.2 サポート・リソース

[テキサス・インスツルメンツ E2E™ サポート・フォーラム](#)は、エンジニアが検証済みの回答と設計に関するヒントをエキスパートから迅速かつ直接得ることができる場所です。既存の回答を検索したり、独自の質問をしたりすることで、設計に必要な支援を迅速に得ることができます。

リンクされているコンテンツは、各寄稿者により「現状のまま」提供されるものです。これらはテキサス・インスツルメンツの仕様を構成するものではなく、必ずしもテキサス・インスツルメンツの見解を反映したものではありません。テキサス・インスツルメンツの[使用条件](#)を参照してください。

5.3 Trademarks

テキサス・インスツルメンツ E2E™ is a trademark of Texas Instruments.
すべての商標は、それぞれの所有者に帰属します。

5.4 静電気放電に関する注意事項



この IC は、ESD によって破損する可能性があります。テキサス・インスツルメンツは、IC を取り扱う際には常に適切な注意を払うことを推奨します。正しい取り扱いおよび設置手順に従わない場合、デバイスを破損するおそれがあります。

ESD による破損は、わずかな性能低下からデバイスの完全な故障まで多岐にわたります。精密な IC の場合、パラメータがわずかに変化するだけで公表されている仕様から外れる可能性があるため、破損が発生しやすくなっています。

5.5 用語集

[テキサス・インスツルメンツ用語集](#) この用語集には、用語や略語の一覧および定義が記載されています。

6 Revision History

資料番号末尾の英字は改訂を表しています。その改訂履歴は英語版に準じています。

Changes from March 6, 2024 to August 1, 2024 (from Revision * (March 2024) to Revision A (August 2024))

	Page
• 「特長」の RF 周波数範囲を 10.2GHz から 12GHz (標準値) に変更	1
• 「概要」の RF 周波数範囲を 10.2GHz から 12GHz に変更	1
• Changed the RF frequency range to 12000MHz.....	6
• Changed the RF frequency range to 12000MHz.....	13

7 Mechanical, Packaging, and Orderable Information

The following pages include mechanical, packaging, and orderable information. This information is the most current data available for the designated devices. This data is subject to change without notice and revision of this document. For browser-based versions of this data sheet, refer to the left-hand navigation.

重要なお知らせと免責事項

テキサス・インスツルメンツは、技術データと信頼性データ (データシートを含みます)、設計リソース (リファレンス デザインを含みます)、アプリケーションや設計に関する各種アドバイス、Web ツール、安全性情報、その他のリソースを、欠陥が存在する可能性のある「現状のまま」提供しており、商品性および特定目的に対する適合性の黙示保証、第三者の知的財産権の非侵害保証を含むいかなる保証も、明示的または黙示的にかかわらず拒否します。

これらのリソースは、テキサス・インスツルメンツ製品を使用する設計の経験を積んだ開発者への提供を意図したものです。(1) お客様のアプリケーションに適した テキサス・インスツルメンツ製品の選定、(2) お客様のアプリケーションの設計、検証、試験、(3) お客様のアプリケーションに該当する各種規格や、その他のあらゆる安全性、セキュリティ、規制、または他の要件への確実な適合に関する責任を、お客様のみが単独で負うものとします。

上記の各種リソースは、予告なく変更される可能性があります。これらのリソースは、リソースで説明されている テキサス・インスツルメンツ製品を使用するアプリケーションの開発の目的でのみ、テキサス・インスツルメンツはその使用をお客様に許諾します。これらのリソースに関して、他の目的で複製することや掲載することは禁止されています。テキサス・インスツルメンツや第三者の知的財産権のライセンスが付与されている訳ではありません。お客様は、これらのリソースを自身で使用した結果発生するあらゆる申し立て、損害、費用、損失、責任について、テキサス・インスツルメンツおよびその代理人を完全に補償するものとし、テキサス・インスツルメンツは一切の責任を拒否します。

テキサス・インスツルメンツの製品は、[テキサス・インスツルメンツの販売条件](#)、または [ti.com](https://www.ti.com) やかかる テキサス・インスツルメンツ製品の関連資料などのいずれかを通じて提供する適用可能な条項の下で提供されています。テキサス・インスツルメンツがこれらのリソースを提供することは、適用されるテキサス・インスツルメンツの保証または他の保証の放棄の拡大や変更を意味するものではありません。

お客様がいかなる追加条項または代替条項を提案した場合でも、テキサス・インスツルメンツはそれらに異議を唱え、拒否します。

郵送先住所: Texas Instruments, Post Office Box 655303, Dallas, Texas 75265

Copyright © 2024, Texas Instruments Incorporated

PACKAGING INFORMATION

Orderable Device	Status (1)	Package Type	Package Drawing	Pins	Package Qty	Eco Plan (2)	Lead finish/ Ball material (6)	MSL Peak Temp (3)	Op Temp (°C)	Device Marking (4/5)	Samples
AFE7950ALKSHP	ACTIVE	FCBGA	ALK	400	90	Non-RoHS & Non-Green	Call TI	Call TI	-40 to 85	AFE7950SHP SNPB	Samples

(1) The marketing status values are defined as follows:

ACTIVE: Product device recommended for new designs.

LIFEBUY: TI has announced that the device will be discontinued, and a lifetime-buy period is in effect.

NRND: Not recommended for new designs. Device is in production to support existing customers, but TI does not recommend using this part in a new design.

PREVIEW: Device has been announced but is not in production. Samples may or may not be available.

OBSOLETE: TI has discontinued the production of the device.

(2) **RoHS:** TI defines "RoHS" to mean semiconductor products that are compliant with the current EU RoHS requirements for all 10 RoHS substances, including the requirement that RoHS substance do not exceed 0.1% by weight in homogeneous materials. Where designed to be soldered at high temperatures, "RoHS" products are suitable for use in specified lead-free processes. TI may reference these types of products as "Pb-Free".

RoHS Exempt: TI defines "RoHS Exempt" to mean products that contain lead but are compliant with EU RoHS pursuant to a specific EU RoHS exemption.

Green: TI defines "Green" to mean the content of Chlorine (Cl) and Bromine (Br) based flame retardants meet JS709B low halogen requirements of <=1000ppm threshold. Antimony trioxide based flame retardants must also meet the <=1000ppm threshold requirement.

(3) MSL, Peak Temp. - The Moisture Sensitivity Level rating according to the JEDEC industry standard classifications, and peak solder temperature.

(4) There may be additional marking, which relates to the logo, the lot trace code information, or the environmental category on the device.

(5) Multiple Device Markings will be inside parentheses. Only one Device Marking contained in parentheses and separated by a "~" will appear on a device. If a line is indented then it is a continuation of the previous line and the two combined represent the entire Device Marking for that device.

(6) Lead finish/Ball material - Orderable Devices may have multiple material finish options. Finish options are separated by a vertical ruled line. Lead finish/Ball material values may wrap to two lines if the finish value exceeds the maximum column width.

Important Information and Disclaimer:The information provided on this page represents TI's knowledge and belief as of the date that it is provided. TI bases its knowledge and belief on information provided by third parties, and makes no representation or warranty as to the accuracy of such information. Efforts are underway to better integrate information from third parties. TI has taken and continues to take reasonable steps to provide representative and accurate information but may not have conducted destructive testing or chemical analysis on incoming materials and chemicals. TI and TI suppliers consider certain information to be proprietary, and thus CAS numbers and other limited information may not be available for release.

In no event shall TI's liability arising out of such information exceed the total purchase price of the TI part(s) at issue in this document sold by TI to Customer on an annual basis.

OTHER QUALIFIED VERSIONS OF AFE7950-SP :

- Catalog : [AFE7950](#)

NOTE: Qualified Version Definitions:

- Catalog - TI's standard catalog product

TRAY

Chamfer on Tray corner indicates Pin 1 orientation of packed units.

*All dimensions are nominal

Device	Package Name	Package Type	Pins	SPQ	Unit array matrix	Max temperature (°C)	L (mm)	W (mm)	K0 (µm)	P1 (mm)	CL (mm)	CW (mm)
AFE7950ALKSHP	ALK	FCBGA	400	90	6 x 15	150	315	135.9	7620	19.5	21	19.2

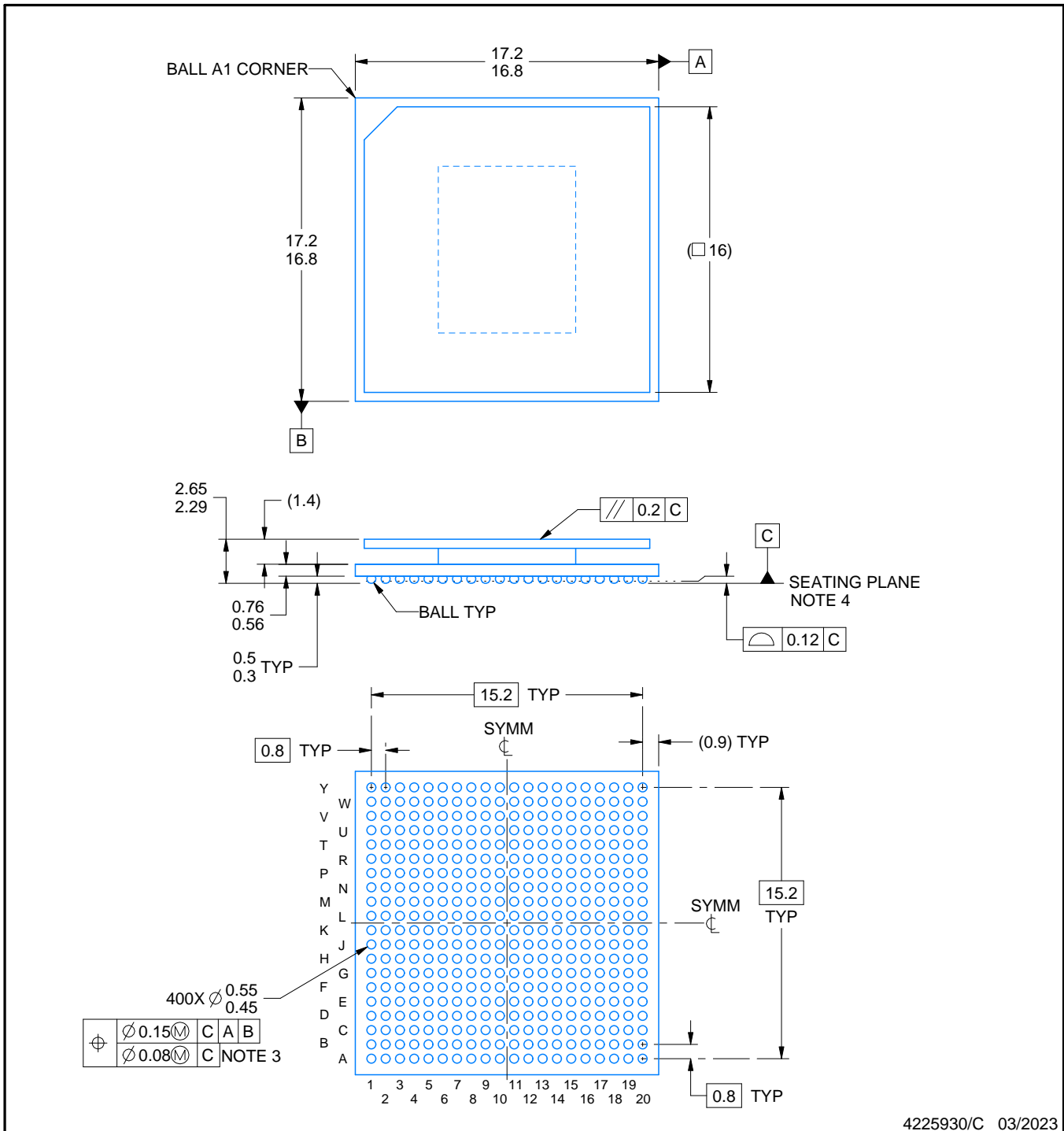
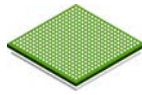

NOTES:

1. All linear dimensions are in millimeters. Any dimensions in parenthesis are for reference only. Dimensioning and tolerancing per ASME Y14.5M.
2. This drawing is subject to change without notice.
3. Dimension is measured at the maximum solder ball diameter, parallel to primary datum C.
4. Primary datum C and seating plane are defined by the spherical crowns of the solder balls.
5. Pb-Free die bump and SnPb solder ball.
6. The lids are electrically floating (e.g. not tied to GND).

EXAMPLE BOARD LAYOUT

ALK0400A

FCBGA - 2.65 mm max height

BALL GRID ARRAY

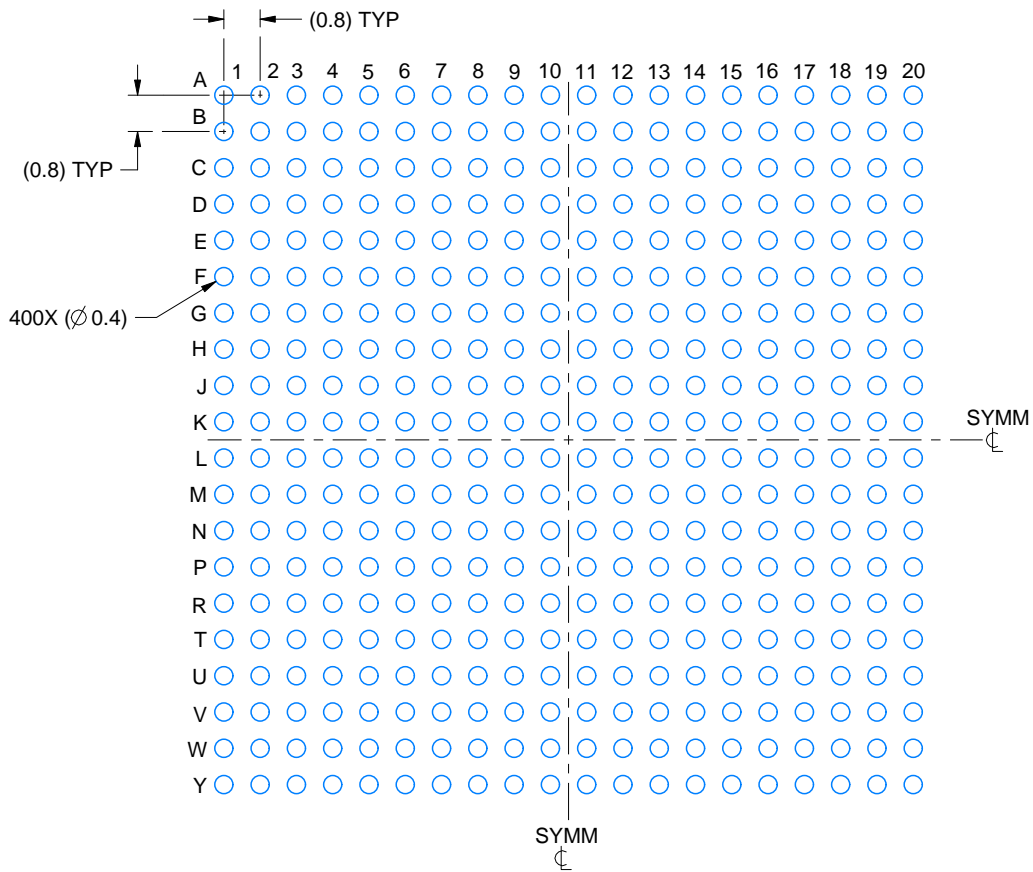

LAND PATTERN EXAMPLE
EXPOSED METAL SHOWN
SCALE:6X



SOLDER MASK DETAILS
NOT TO SCALE

4225930/C 03/2023

NOTES: (continued)

- Final dimensions may vary due to manufacturing tolerance considerations and also routing constraints. For more information, see Texas Instruments literature number SPRU811 (www.ti.com/lit/spru811).

EXAMPLE STENCIL DESIGN

ALK0400A

FCBGA - 2.65 mm max height

BALL GRID ARRAY

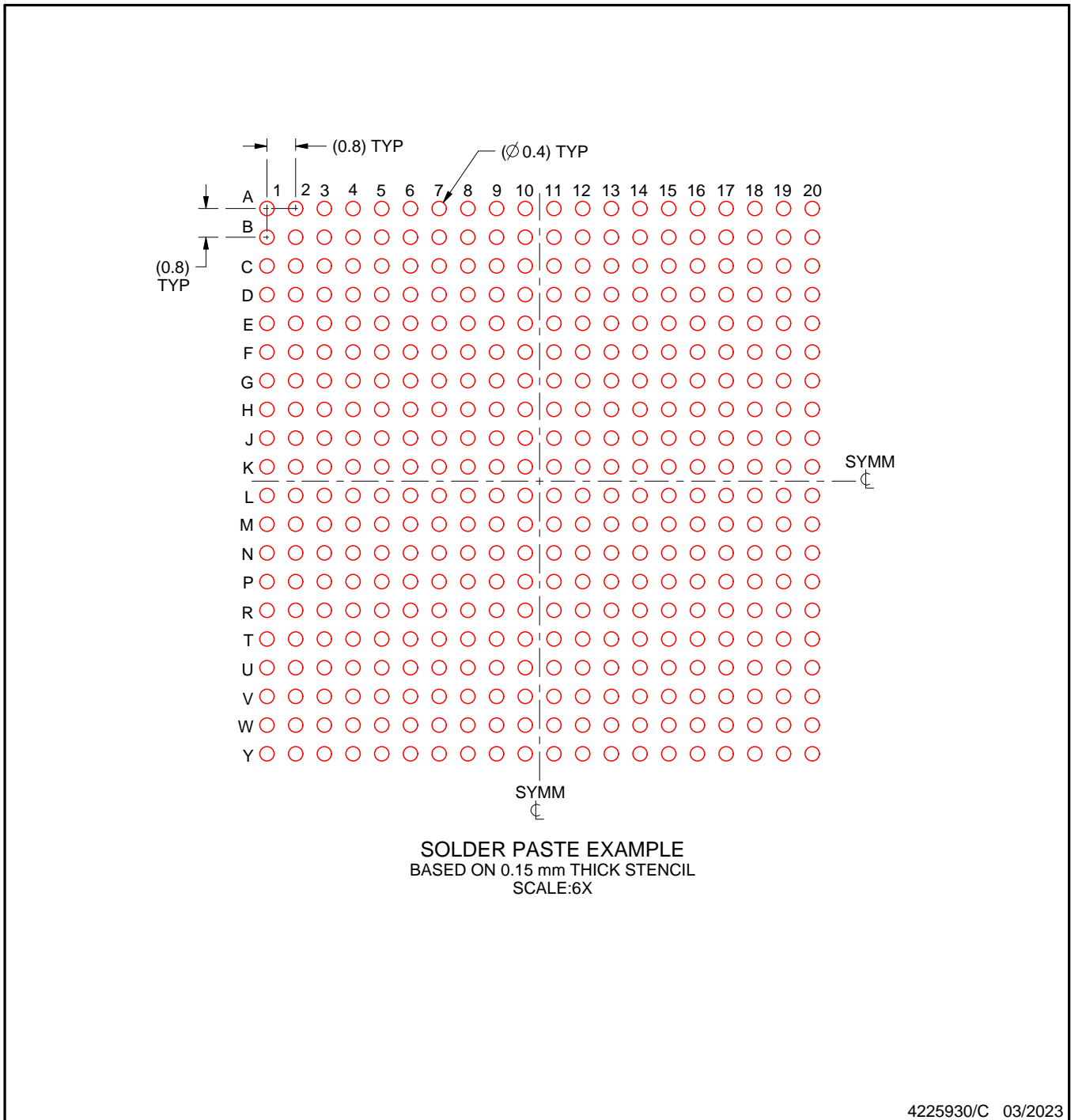

NOTES: (continued)

8. Laser cutting apertures with trapezoidal walls and rounded corners may offer better paste release.

重要なお知らせと免責事項

TI は、技術データと信頼性データ (データシートを含みます)、設計リソース (リファレンス・デザインを含みます)、アプリケーションや設計に関する各種アドバイス、Web ツール、安全性情報、その他のリソースを、欠陥が存在する可能性のある「現状のまま」提供しており、商品性および特定目的に対する適合性の黙示保証、第三者の知的財産権の非侵害保証を含むいかなる保証も、明示的または黙示的にかかわらず拒否します。

これらのリソースは、TI 製品を使用する設計の経験を積んだ開発者への提供を意図したものです。(1) お客様のアプリケーションに適した TI 製品の選定、(2) お客様のアプリケーションの設計、検証、試験、(3) お客様のアプリケーションに該当する各種規格や、その他のあらゆる安全性、セキュリティ、規制、または他の要件への確実な適合に関する責任を、お客様のみが単独で負うものとし、

上記の各種リソースは、予告なく変更される可能性があります。これらのリソースは、リソースで説明されている TI 製品を使用するアプリケーションの開発の目的でのみ、TI はその使用をお客様に許諾します。これらのリソースに関して、他の目的で複製することや掲載することは禁止されています。TI や第三者の知的財産権のライセンスが付与されている訳ではありません。お客様は、これらのリソースを自身で使用した結果発生するあらゆる申し立て、損害、費用、損失、責任について、TI およびその代理人を完全に補償するものとし、TI は一切の責任を拒否します。

TI の製品は、[TI の販売条件](#)、または [ti.com](#) やかかる TI 製品の関連資料などのいずれかを通じて提供する適用可能な条項の下で提供されています。TI がこれらのリソースを提供することは、適用される TI の保証または他の保証の放棄の拡大や変更を意味するものではありません。

お客様がいかなる追加条項または代替条項を提案した場合でも、TI はそれらに異議を唱え、拒否します。

郵送先住所 : Texas Instruments, Post Office Box 655303, Dallas, Texas 75265
Copyright © 2024, Texas Instruments Incorporated