

ADS1285 地震計アプリケーション向け、32 ビット、デルタ-シグマ ADC

1 特長

- 分解能と電力モードを選択可能:
 - ダイナミック・レンジ: 134dB (2ms, 11.5mW)
 - ダイナミック・レンジ: 129 dB (2ms, 4.8 mW)
- フレキシブルなデジタル・フィルタ:
 - Sinc + FIR + IIR (選択可能)
 - 線形または最小位相
 - ハイパス・フィルタ
- THD: < -120dB
- CMRR: 125dB
- データ・レート: 125SPS~4000SPS
- プログラマブル・ゲイン: 1~64
- PGA バイパス・オプション
- SYNC 入力
- クロック誤差補償
- 2 チャンネル・マルチプレクサ
- オフセットおよびゲインの校正
- 汎用デジタル I/O
- アナログ電源の動作: 5V, 3.3V または $\pm 2.5V$
- 基準電圧の選択: 5V, 4.096V, 2.5V

2 アプリケーション

- エネルギー探査
- 受動的地震波観測
- 地球科学および地質学
- 高精度計測機器

3 概要

ADS1285 は、プログラマブル・ゲイン・アンプ (PGA) と有限インパルス応答 (FIR) フィルタを備えた 32 ビット、低消費電力の A/D コンバータ (ADC) です。この ADC は、低ノイズで高精度のデジタル化と長いバッテリー動作時間が求められる地震関連機器の厳しい要件に合わせて設計されています。

低ノイズ PGA により、外付けアンプを使用せずに、ジオフォンのトランス結合のハイドロフォンを直接接続できます。

この ADC は、高分解能のデルタ-シグマ ($\Delta\Sigma$) 変調器と、位相応答を設定できる FIR フィルタを内蔵しています。ハイパス・フィルタは、DC および低周波数成分を信号から除去します。サンプル・レート・コンバータは、7ppb の分解能でクロック周波数誤差を補償します。

電力モードの選択により、消費電力とダイナミック・レンジを最適化できます。PGA バイパス動作により、消費電力をさらに低減できます。

この ADC は小型の 5mm × 5mm VQFN パッケージで供給され、 -40°C ~ $+85^{\circ}\text{C}$ の周囲温度範囲で仕様が規定されています。

パッケージ情報 (1)

部品番号	パッケージ	本体サイズ (公称)
ADS1285	RHB (VQFN, 32)	5.00mm × 5.00mm

(1) 利用可能なパッケージについては、データシートの末尾にあるパッケージ・オプションについての付録を参照してください。

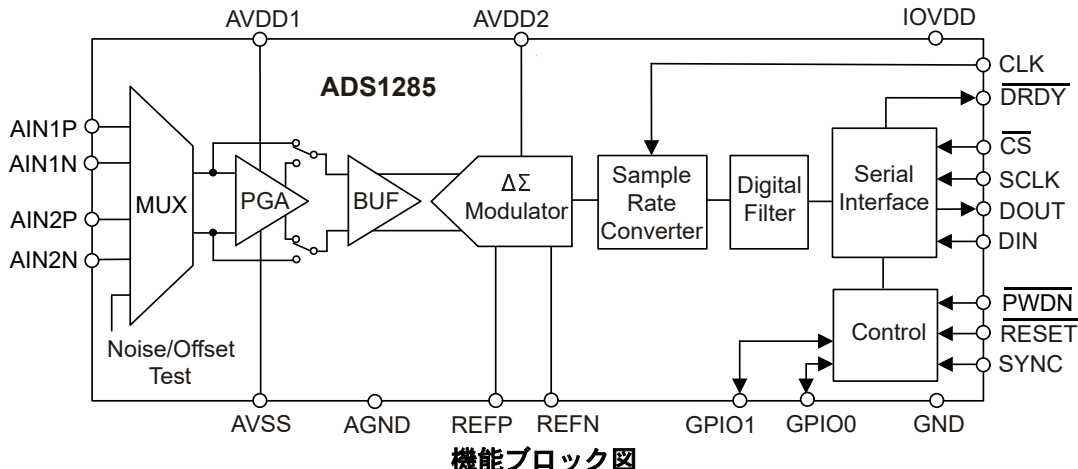

Table of Contents

1 特長	1	8.1 Overview.....	25
2 アプリケーション	1	8.2 Functional Block Diagram.....	26
3 概要	1	8.3 Feature Description.....	27
4 Revision History	2	8.4 Device Functional Modes.....	40
5 Pin Configuration and Functions	3	8.5 Programming.....	44
6 Specifications	4	8.6 Register Map.....	49
6.1 Absolute Maximum Ratings.....	4	9 Application and Implementation	54
6.2 ESD Ratings.....	4	9.1 Application Information.....	54
6.3 Recommended Operating Conditions.....	4	9.2 Typical Application.....	54
6.4 Thermal Information.....	5	9.3 Power Supply Recommendations.....	56
6.5 Electrical Characteristics.....	6	9.4 Layout.....	57
6.6 Timing Requirements: 1.65 V ≤ IOVDD ≤ 1.95 V and 2.7 V ≤ IOVDD ≤ 3.6 V.....	10	10 Device and Documentation Support	58
6.7 Switching Characteristics: 1.65V ≤ IOVDD ≤ 1.95V and 2.7 V ≤ IOVDD ≤ 3.6 V.....	10	10.1 Receiving Notification of Documentation Updates..	58
6.8 Timing Diagrams.....	11	10.2 サポート・リソース.....	58
6.9 Typical Characteristics.....	13	10.3 Trademarks.....	58
7 Parameter Measurement Information	23	10.4 Electrostatic Discharge Caution.....	58
7.1 Noise Performance.....	23	10.5 Glossary.....	58
8 Detailed Description	25	11 Mechanical, Packaging, and Orderable Information	58

4 Revision History

資料番号末尾の英字は改訂を表しています。その改訂履歴は英語版に準じています。

Changes from Revision * (May 2022) to Revision A (December 2022)	Page
• 初の一般公開、ドキュメントのステータスを「事前情報」から「量産データ」に変更.....	1

5 Pin Configuration and Functions



图 5-1. RHB Package, 32-Pin, 5-mm × 5-mm VQFN (Top View)

表 5-1. Pin Functions

PIN		FUNCTION	DESCRIPTION
NO.	NAME		
1	AIN1P	Analog input	Channel 1 positive input
2	AIN1N	Analog input	Channel 1 negative input
3	AIN2P	Analog input	Channel 2 positive input
4	AIN2N	Analog input	Channel 2 negative input
5	CAPP	Analog internal	PGA positive capacitor. Connect a 10-nF C0G capacitor across CAPP and CAPN.
6	CAPN	Analog internal	PGA negative capacitor. Connect a 10-nF C0G capacitor across CAPP and CAPN.
7	CAPBP	Analog internal	Buffer positive capacitor. Connect a 47-nF C0G capacitor to AVSS.
8	CAPBN	Analog internal	Buffer negative capacitor. Connect a 47-nF C0G capacitor to AVSS.
9	CAPC	Analog internal	Charge-pump capacitor. Connect a 4.7-nF, minimum 10-V rated capacitor to AGND.
10	AVSS	Analog supply	PGA negative analog supply. See the Analog Power Supplies section for details.
11	AVDD1	Analog supply	PGA positive analog supply. See the Analog Power Supplies section for details.
12	AVDD2	Analog supply	Modulator analog supply. See the Analog Power Supplies section for details.
13	AGND	Analog ground	Analog ground
14	CAPI	Analog internal	Input bias capacitor. Connect a 100-nF ceramic capacitor to AGND.
15	GPIO0	Digital I/O	General-purpose I/O
16	GPIO1	Digital I/O	General-purpose I/O
17	CAPD	Analog output	Digital low-dropout regulator (LDO) output. Connect a 220-nF ceramic capacitor to DGND.
18	DGND	Ground	Digital ground
19	IOVDD	Digital supply	Digital I/O power supply. See the IOVDD Power Supply section for details.
20	CLK	Digital input	ADC clock input
21	\overline{CS}	Digital input	Serial interface select, active low
22	SCLK	Digital input	Serial interface clock
23	DIN	Digital input	Serial interface data in
24	DOUT	Digital output	Serial interface data out
25	DRDY	Digital output	Data ready, active low
26	SYNC	Digital input	ADC synchronization, active high
27	RESET	Digital input	ADC reset, active low
28	PWDN	Digital input	ADC power down, active low
29	REFN	Analog input	Negative reference input. See the Voltage Reference Input section for details.
30	REFP	Analog input	Positive reference input. See the Voltage Reference Input section for details.
31	CAPR	Analog internal	Reference bias capacitor. Connect a 100-nF ceramic capacitor to AVSS.
32	AVSS	Analog supply	PGA negative supply
Thermal pad		Connect the thermal pad to AVSS. Thermal vias placed in the printed circuit board (PCB) land are optional for placement of bottom side components.	

6 Specifications

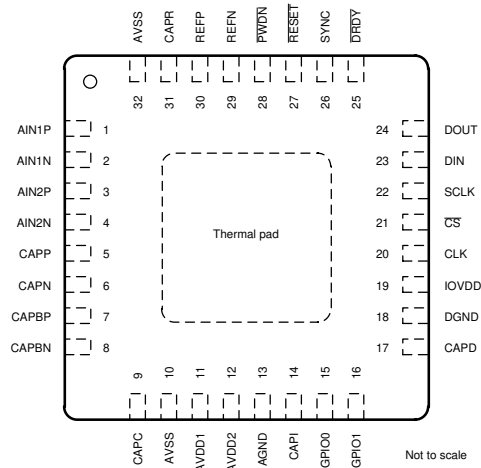
6.1 Absolute Maximum Ratings

over operating free-air temperature range (unless otherwise noted)⁽¹⁾

		MIN	MAX	UNIT
Power supply voltages	AVDD1 to AVSS	-0.3	5.5	V
	AVSS to AGND	-2.8	0.3	
	AVDD2 to AGND	-0.3	5.5	
	AVDD2 to AVSS	-0.3	5.5	
	IOVDD to DGND	-0.3	3.9	
	IOVDD to DGND (IOVDD connected to CAPD)	-0.3	2.2	
Grounds	AGND to DGND	-0.3	0.3	V
Analog input voltage	AIN1P, AIN1N, AIN2P, AIN2N, REFP, REFN	AVSS - 0.3	AVDD1 + 0.3	V
Digital input voltage	CLK, DIN, SCLK, \overline{CS} , GPIO0, GPIO1, SYNC, RESET, PWDN	DGND - 0.3	IOVDD + 0.3	V
Input current	Continuous, any digital or analog pin ⁽²⁾	-10	10	mA
Temperature	Junction, T _J		150	°C
	Storage, T _{stg}	-60	150	°C

- (1) Operation outside the Absolute Maximum Ratings may cause permanent device damage. Absolute Maximum Ratings do not imply functional operation of the device at these or any other conditions beyond those listed under Recommended Operating Conditions. If briefly operating outside the Recommended Operating Conditions but within the Absolute Maximum Ratings, the device may not sustain damage, but it may not be fully functional – this may affect device reliability, functionality, performance, and shorten the device lifetime.
- (2) Analog input pins AIN1P, AIN1N, AIN2P, AIN2N, REFP and REFN are diode-clamped to AVDD1 and AVSS. Limit the input current to 10 mA in the event the analog input voltage exceeds AVDD1 + 0.3 V or AVSS - 0.3 V. Digital input pins are clamped to IOVDD and DGND. Limit the input current if the digital input voltage exceeds IOVDD + 0.3 V or DGND - 0.3 V.

6.2 ESD Ratings

			VALUE	UNIT
V _(ESD)	Electrostatic discharge	Human-body model (HBM), per ANSI/ESDA/JEDEC JS-001 ⁽¹⁾	2000	V
		Charged-device model (CDM), per JEDEC JESD22-C101 ⁽²⁾	1000	

- (1) JEDEC document JEP155 states that 500-V HBM allows safe manufacturing with a standard ESD control process.
- (2) JEDEC document JEP157 states that 250-V CDM allows safe manufacturing with a standard ESD control process.

6.3 Recommended Operating Conditions

over operating ambient temperature range (unless otherwise noted)

			MIN	NOM	MAX	UNIT
POWER SUPPLY						
	Analog power supplies	AVDD1 to AVSS	3		5.25	V
		AVDD1 to AGND	2.375			
		AVSS to AGND	-2.625		0	
		AVDD2 to AGND	2.375		5.25	
		AVDD2 to AVSS			5.25	
	Digital power supply	IOVDD to DGND	2.7		3.6	V
		IOVDD connected to CAPD	1.65		1.95	
ANALOG INPUTS						
V _{IN}	Differential input voltage V _{IN} = V _{AINP} - V _{AINN}	Reference voltage = 5 V			±V _{REF} / (2 × Gain)	V
		Reference voltage = 4.096 V			±V _{REF} / (1.6384 × Gain)	
		Reference voltage = 2.5 V			±V _{REF} / Gain	
	Absolute input voltage	Buffer operation	AVSS + 0.1		AVDD1 - 0.1	V
		PGA operation	AVSS + 1.1		AVDD1 - 0.85	
	Absolute output voltage	Buffer operation	AVSS + 0.1		AVDD1 - 0.1	V
		PGA operation	AVSS + 0.15		AVDD1 - 0.15	

6.3 Recommended Operating Conditions (continued)

over operating ambient temperature range (unless otherwise noted)

			MIN	NOM	MAX	UNIT	
	Calibration range ⁽¹⁾				6%	FSR	
VOLTAGE REFERENCE INPUT							
V _{REFN}	Negative reference input		AVSS – 0.05			V	
V _{REFP}	Positive reference input		AVDD1 + 0.1			V	
V _{REF}	V _{REF} = V _{REFP} – V _{REFN}	Reference voltage = 5 V	4.9	5	AVDD1 – AVSS + 0.1	V	
		Reference voltage = 4.096 V	4.0	4.096	4.2	V	
		Reference voltage = 2.5 V	2.4	2.5	2.6	V	
DIGITAL INPUTS							
V _{INL}	Low-level input voltage		0.2 × IOVDD			V	
V _{INH}	High-level input voltage		0.8 × IOVDD			V	
f _{CLK}	Clock input frequency	High-power mode	6	8.192	8.3	MHz	
		Mid-power mode	6	8.192	8.3		
		Low-power mode	3	4.096	4.15		
TEMPERATURE							
T _A	Ambient temperature	Operational	–50			85	°C
		Specification	–40			85	

(1) Calibration range is the sum of the offset and gain error correction.

6.4 Thermal Information

THERMAL METRIC ⁽¹⁾		ADS1285	UNIT
		RHB (VQFN)	
		32 PINS	
R _{θJA}	Junction-to-ambient thermal resistance	30	°C/W
R _{θJC(top)}	Junction-to-case (top) thermal resistance	19.4	°C/W
R _{θJB}	Junction-to-board thermal resistance	10.9	°C/W
ψ _{JT}	Junction-to-top characterization parameter	0.2	°C/W
ψ _{JB}	Junction-to-board characterization parameter	10.8	°C/W
R _{θJC(bot)}	Junction-to-case (bottom) thermal resistance	1.8	°C/W

(1) For more information about traditional and new thermal metrics, see the [Semiconductor and IC Package Thermal Metrics](#) application report.

6.5 Electrical Characteristics

minimum and maximum specifications over -40°C to $+85^{\circ}\text{C}$; typical specifications are at 25°C ; all specifications are at $\text{AVDD1} = 5\text{ V}$, $\text{AVDD2} = 2.5\text{ V}$ to 5 V , $\text{AVSS} = 0\text{ V}$, $\text{IOVDD} = 1.8\text{ V}$, $\text{V}_{\text{REFP}} = 4.096\text{ V}$, $\text{V}_{\text{REFN}} = 0\text{ V}$, $\text{V}_{\text{CM}} = 2.5\text{ V}$, PGA gain = 1, $f_{\text{CLK}} = 8.192\text{ MHz}$ (4.096 MHz low-power mode) and $f_{\text{DATA}} = 500\text{ SPS}$ (unless otherwise noted)

PARAMETER		TEST CONDITIONS		MIN	TYP	MAX	UNIT
ANALOG INPUTS							
	Input mux on-resistance	Input 1 to input 2 cross connection			60		Ω
PGA OPERATION							
I_B	PGA Input bias current	High-power mode			45		nA
I_{OS}	PGA Input offset current	High-power mode			± 3		nA
	PGA Gain			1, 2, 4, 8, 16, 32, 64			V/V
$e_{n\text{-PGA}}$	PGA Input voltage noise density	High-power mode	PGA Gain = 16		5.5		nV/ $\sqrt{\text{Hz}}$
		Mid-power mode			7		
		Low-power mode			7		
$i_{n\text{-PGA}}$	PGA Input current noise density	Differential			2.5		pA/ $\sqrt{\text{Hz}}$
	Antialias filter frequency				30		kHz
BUFFER OPERATION							
I_B	Input current	High-power mode	$V_{\text{IN}} = 2.5\text{ V}$		± 1.2		μA
		Mid-power mode			± 1.2		
		Low-power mode			± 0.3		
DC PERFORMANCE							
e_n	Noise			See Noise Performance section for details			
V_{OS}	Offset error	PGA operation		$-350/\text{gain} - 10$	$\pm 30/\text{gain} + 5$	$350/\text{gain} + 10$	μV
		Buffer operation		-600	± 50	600	
		After calibration			± 1		
	Offset error drift	PGA operation			$0.5/\text{gain}$		$\mu\text{V}/^{\circ}\text{C}$
		Buffer operation			1		
	Gain error	PGA operation, gain = 1		-0.05%	$\pm 0.02\%$	0.05%	ppm
		After calibration			2		
		Buffer operation		-0.07%	$\pm 0.05\%$	0.07%	
	Gain match	Relative to PGA gain = 1		-0.2%	$\pm 0.06\%$	0.2%	
	Gain drift	All PGA gains			2		ppm/ $^{\circ}\text{C}$
CMRR	Common-mode rejection ratio	$f = 60\text{ Hz}$		104	120		dB
PSRR	Power-supply rejection ratio	AVDD2	At dc	80	95		dB
		AVSS, AVDD1		85	110		dB
		IOVDD		100	120		dB

6.5 Electrical Characteristics (continued)

minimum and maximum specifications over -40°C to $+85^{\circ}\text{C}$; typical specifications are at 25°C ; all specifications are at $\text{AVDD1} = 5\text{ V}$, $\text{AVDD2} = 2.5\text{ V}$ to 5 V , $\text{AVSS} = 0\text{ V}$, $\text{IOVDD} = 1.8\text{ V}$, $V_{\text{REFP}} = 4.096\text{ V}$, $V_{\text{REFN}} = 0\text{ V}$, $V_{\text{CM}} = 2.5\text{ V}$, PGA gain = 1, $f_{\text{CLK}} = 8.192\text{ MHz}$ (4.096 MHz low-power mode) and $f_{\text{DATA}} = 500\text{ SPS}$ (unless otherwise noted)

PARAMETER		TEST CONDITIONS		MIN	TYP	MAX	UNIT
AC PERFORMANCE							
$e_{\text{R-MOD}}$	Modulator voltage noise density	$V_{\text{REF}} = 4.096\text{ V}$			25		$\text{nV}/\sqrt{\text{Hz}}$
THD	Total harmonic distortion	High-power mode, $V_{\text{REF}} = 2.5\text{ V}$, $\text{AVDD1} = 3.3\text{ V}$, $\text{AVSS} = 0\text{ V}$, $f_{\text{IN}} = 31.25\text{ Hz}$, $V_{\text{IN}} = -0.5\text{ dBFS}$	Buffer operation		-123	-114	dB
			PGA gain = 2		-119		
			PGA gain = 4		-125	-116	
			PGA gain = 8		-124		
			PGA gain = 16		-123	-116	
			PGA gain = 32 and 64		-125		
		Mid-power mode, $V_{\text{REF}} = 2.5\text{ V}$, $\text{AVDD1} = 3.3\text{ V}$, $\text{AVSS} = 0\text{ V}$, $f_{\text{IN}} = 31.25\text{ Hz}$, $V_{\text{IN}} = -0.5\text{ dBFS}$	Buffer operation		-122	-113	dB
			PGA gain = 2		-120		
			PGA gain = 4		-125	-118	
			PGA gain = 8		-124		
			PGA gain = 16		-123	-115	
			PGA gain = 32 and 64		-125		
		Low-power mode, $V_{\text{REF}} = 2.5\text{ V}$, $\text{AVDD1} = 3.3\text{ V}$, $\text{AVSS} = 0\text{ V}$, $f_{\text{IN}} = 31.25\text{ Hz}$, $V_{\text{IN}} = -0.5\text{ dBFS}$	Buffer operation		-124	-117	dB
			PGA gain = 2		-122		
			PGA gain = 4		-124	-116	
			PGA gain = 8		-125		
			PGA gain = 16		-123	-115	
			PGA gain = 32 and 64		-124		
		High-power mode, $V_{\text{REF}} = 4.096\text{ V}$, $\text{AVDD1} = 5\text{ V}$, $\text{AVSS} = 0\text{ V}$, $f_{\text{IN}} = 31.25\text{ Hz}$, $V_{\text{IN}} = -0.5\text{ dBFS}$	Buffer operation		-119	-114	dB
			PGA gain = 1		-119	-111	
			PGA gain = 2		-125		
			PGA gain = 4		-122	-114	
			PGA gain = 8		-118		
			PGA gain = 16		-117	-111	
Mid-power mode, $V_{\text{REF}} = 4.096\text{ V}$, $\text{AVDD1} = 5\text{ V}$, $\text{AVSS} = 0\text{ V}$, $f_{\text{IN}} = 31.25\text{ Hz}$, $V_{\text{IN}} = -0.5\text{ dBFS}$	Buffer operation		-119	-112	dB		
	PGA gain = 1		-119	-111			
	PGA gain = 2		-125				
	PGA gain = 4		-124	-115			
	PGA gain = 8		-119				
	PGA gain = 16		-117	-111			
Low-power mode, $V_{\text{REF}} = 4.096\text{ V}$, $\text{AVDD1} = 5\text{ V}$, $\text{AVSS} = 0\text{ V}$, $f_{\text{IN}} = 31.25\text{ Hz}$, $V_{\text{IN}} = -0.5\text{ dBFS}$	Buffer operation		-123	-117	dB		
	PGA gain = 1		-121	-115			
	PGA gain = 2		-124				
	PGA gain = 4		-125	-115			
	PGA gain = 8		-122				
	PGA gain = 16		-121	-113			
SFDR	Spurious-free dynamic range	$f_{\text{IN}} = 31.25\text{ Hz}$, $V_{\text{IN}} = -0.5\text{ dBFS}$			115		dB
	Crosstalk	$f_{\text{IN}} = 31.25\text{ Hz}$, $V_{\text{IN}} = -0.5\text{ dBFS}$			-140		dB

6.5 Electrical Characteristics (continued)

minimum and maximum specifications over -40°C to $+85^{\circ}\text{C}$; typical specifications are at 25°C ; all specifications are at $\text{AVDD1} = 5\text{ V}$, $\text{AVDD2} = 2.5\text{ V}$ to 5 V , $\text{AVSS} = 0\text{ V}$, $\text{IOVDD} = 1.8\text{ V}$, $V_{\text{REFP}} = 4.096\text{ V}$, $V_{\text{REFN}} = 0\text{ V}$, $V_{\text{CM}} = 2.5\text{ V}$, PGA gain = 1, $f_{\text{CLK}} = 8.192\text{ MHz}$ (4.096 MHz low-power mode) and $f_{\text{DATA}} = 500\text{ SPS}$ (unless otherwise noted)

PARAMETER		TEST CONDITIONS		MIN	TYP	MAX	UNIT	
VOLTAGE REFERENCE INPUT								
	Reference input current	High-power mode			110		$\mu\text{A/V}$	
		Mid-power mode			110			
		Low-power mode			80			
FIR DIGITAL FILTER								
f_{DATA}	Data rate	High-power mode		250		4000	SPS	
		Mid-power mode		250		4000		
		Low-power mode		125		2000		
	Pass-band ripple			-0.003		0.003	dB	
	Pass-band (-0.01 dB)			$0.375 \times f_{\text{DATA}}$			Hz	
	Bandwidth (-3 dB)			$0.413 \times f_{\text{DATA}}$			Hz	
	Stop band			$0.5 \times f_{\text{DATA}}$			Hz	
	Stop-band attenuation ⁽¹⁾			135			dB	
	Group delay	Minimum phase filter, at dc		$5 / f_{\text{DATA}}$			s	
		Linear phase filter		$31 / f_{\text{DATA}}$				
	Settling time (latency)	Minimum phase filter		$62 / f_{\text{DATA}}$			s	
		Linear phase filter		$62 / f_{\text{DATA}}$				
IIR DIGITAL FILTER								
	High-pass corner frequency			0.1		10	Hz	
SAMPLE RATE CONVERTER								
	Clock compensation range			-244		244	ppm of f_{CLK}	
	Resolution				7.45		ppb of f_{CLK}	
DIGITAL INPUT/OUTPUT								
V_{OH}	High-level output voltage	$I_{\text{OH}} = 1\text{ mA}$		$0.8 \times \text{IOVDD}$			V	
V_{OL}	Low-level output voltage	$I_{\text{OL}} = -1\text{ mA}$			$0.2 \times \text{IOVDD}$		V	
I_{kg}	Input leakage			-1		1	μA	
POWER SUPPLY								
$I_{\text{AVDD1}}, I_{\text{AVSS}}$	AVDD1, AVSS current	High-power mode AVDD1 = 3.3 V	PGA operation		1.4		mA	
			Buffer operation		0.25			
		Mid-power mode AVDD1 = 3.3 V	PGA operation		0.85		mA	
			Buffer operation		0.25			
		Low-power mode AVDD1 = 3.3 V	PGA operation		0.8		mA	
			Buffer operation		0.2			
		High-power mode AVDD1 = 5 V	PGA operation		1.5	1.85	mA	
			Buffer operation		0.35	0.45		
		Mid-power mode AVDD1 = 5 V	PGA operation		0.9	1.2	mA	
			Buffer operation		0.35	0.45		
Low-power mode AVDD1 = 5 V	PGA operation		0.85	1.1	mA			
	Buffer operation		0.25	0.45				
	Power-down mode			1		5	μA	
I_{AVDD2}	AVDD2 current		AVDD2 = 2.5 V	High-power mode		1.2	1.5	mA
				Mid-power mode		1.2	1.5	
				Low-power mode		0.7	0.85	
				Power-down mode		1	5	μA

6.5 Electrical Characteristics (continued)

minimum and maximum specifications over -40°C to $+85^{\circ}\text{C}$; typical specifications are at 25°C ; all specifications are at $\text{AVDD1} = 5\text{ V}$, $\text{AVDD2} = 2.5\text{ V}$ to 5 V , $\text{AVSS} = 0\text{ V}$, $\text{IOVDD} = 1.8\text{ V}$, $V_{\text{REFP}} = 4.096\text{ V}$, $V_{\text{REFN}} = 0\text{ V}$, $V_{\text{CM}} = 2.5\text{ V}$, PGA gain = 1, $f_{\text{CLK}} = 8.192\text{ MHz}$ (4.096 MHz low-power mode) and $f_{\text{DATA}} = 500\text{ SPS}$ (unless otherwise noted)

PARAMETER		TEST CONDITIONS		MIN	TYP	MAX	UNIT
I_{IOVDD}	IOVDD current	High-power mode			0.43	0.6	mA
		Mid-power mode			0.43	0.6	
		Low-power mode			0.24	0.4	
		Power-down mode			1	10	μA
		Standby mode			200		
	IOVDD additional current	High-power mode	Sample rate converter operation		1.2		mA
Mid-power mode				1.2			
Low-power mode				0.6			
P_{d}	Power dissipation ⁽²⁾	High-power mode AVDD1 = 3.3 V AVDD2 = 2.5 V	PGA operation		8.3		mW
			Buffer operation		4.5		
		Mid-power mode AVDD1 = 3.3 V AVDD2 = 2.5 V	PGA operation		6.5		mW
			Buffer operation		4.5		
		Low-power mode AVDD1 = 3.3 V AVDD2 = 2.5 V	PGA operation		4.8		mW
			Buffer operation		2.8		
		High-power mode AVDD1 = 5 V AVDD2 = 2.5 V	PGA operation		11.5	14.1	mW
			Buffer operation		5.3	6.7	
		Mid-power mode AVDD1 = 5 V AVDD2 = 2.5 V	PGA operation		8.3	10.8	mW
			Buffer operation		5.3	6.7	
		Low-power mode AVDD1 = 5 V AVDD2 = 2.5 V	PGA operation		6.4	8.4	mW
			Buffer operation		3.4	5.1	

- (1) Input frequencies at $N \times 32\text{ kHz}$ (16 kHz low-power mode) $\pm f_{\text{DATA}} / 2$ (where $N = 1, 2, 3, \dots$) intermodulate with the chopper clock. At these frequencies stop band attenuation = -90 dBFS (typ).
- (2) Excluding current consumed by the voltage reference input or by sample rate converter operation. See voltage reference input current and IOVDD current of sample rate converter operation.

6.6 Timing Requirements: 1.65 V ≤ IOVDD ≤ 1.95 V and 2.7 V ≤ IOVDD ≤ 3.6 V

over operating ambient temperature range (unless otherwise noted)

		MIN	NOM	MAX	UNIT	
CLOCK						
t _c (CLK)	CLK period	High-power mode	120.5	122.07	166	ns
		Mid-power mode	120.5	122.07	166	
		Low-power mode	241	244.14	332	
t _w (CLKH)	Pulse duration, CLK high	High-power mode	55			ns
		Mid-power mode	55			
		Low-power mode	110			
t _w (CLKL)	Pulse duration, CLK low	High-power mode	55			ns
		Mid-power mode	55			
		Low-power mode	110			
SERIAL INTERFACE						
t _w (CSH)	Pulse duration, CS high	20			ns	
t _d (CSSC)	Delay time, first SCLK rising edge after CS falling edge	20			ns	
t _c (SCLK)	SCLK period	120			ns	
t _w (SCH)	Pulse duration, SCLK high	50			ns	
t _w (SCL)	Pulse duration, SCLK low	50			ns	
t _{su} (DI)	Setup time, DIN valid before SCLK rising edge	10			ns	
t _h (DI)	Hold time, DIN valid after SCLK rising edge	10			ns	
t _{su} (SRC-W)	Setup time, SRC[1:0] register write before DRDY falling edge	256			1 / f _(CLK)	
SYNC						
t _w (SYNL)	Pulse duration, SYNC low	2			1 / f _(CLK)	
t _w (SYNH)	Pulse duration, SYNC high	2			1 / f _(CLK)	
t _{su} (SYNCLK)	Setup time, SYNC high before CLK rising edge	10			ns	
t _h (SYNCLK)	Hold time, SYNC high after CLK rising edge	10			ns	
RESET						
t _w (RSTL)	Pulse duration, RESET low	2			1 / f _(CLK)	
t _{su} (RSTCLK)	Setup time, RESET high before CLK rising edge	10			ns	
t _h (RSTCLK)	Hold time, RESET high after CLK rising edge	10			ns	

6.7 Switching Characteristics: 1.65V ≤ IOVDD ≤ 1.95V and 2.7 V ≤ IOVDD ≤ 3.6 V

over operating ambient temperature range and C_{LOAD} = 20pF (unless otherwise noted)

PARAMETER		MIN	TYP	MAX	UNIT
SERIAL INTERFACE					
t _w (DRH)	Pulse duration, DRDY high			8	1 / f _(CLK)
t _p (CSDO)	Propagation delay time, CS falling edge to DOUT driven valid			50	ns
t _p (SCDO)	Propagation delay time, SCLK falling edge to new DOUT valid			50	ns
t _h (SCDO)	Propagation delay time, SCLK falling edge to DOUT invalid	5			ns
SYNC					
t _p (SYNDR)	Propagation delay time, SYNC rising edge to valid data DRDY falling edge	62.98145 / f _{DATA} + 930 / f _{CLK}			s
RESET					
t _p (RSTDR)	Propagation delay time, RESET rising edge to DRDY falling edge	516,874			1 / f _{CLK}
PWDN					
t _p (PDDR)	Propagation delay time, PWDN rising edge to DRDY falling edge	62.98145 / f _{DATA} + 946 / f _(CLK)			s
POWER UP					
t _p (SUPDR)	Propagation delay time, power supply and CLK applied to first DRDY pulse	650,000			1 / f _{CLK}

6.8 Timing Diagrams

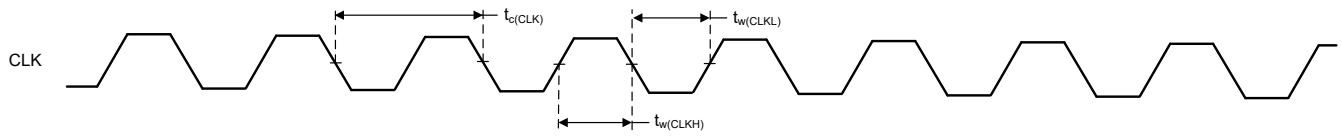

6-1. Clock Timing Requirements

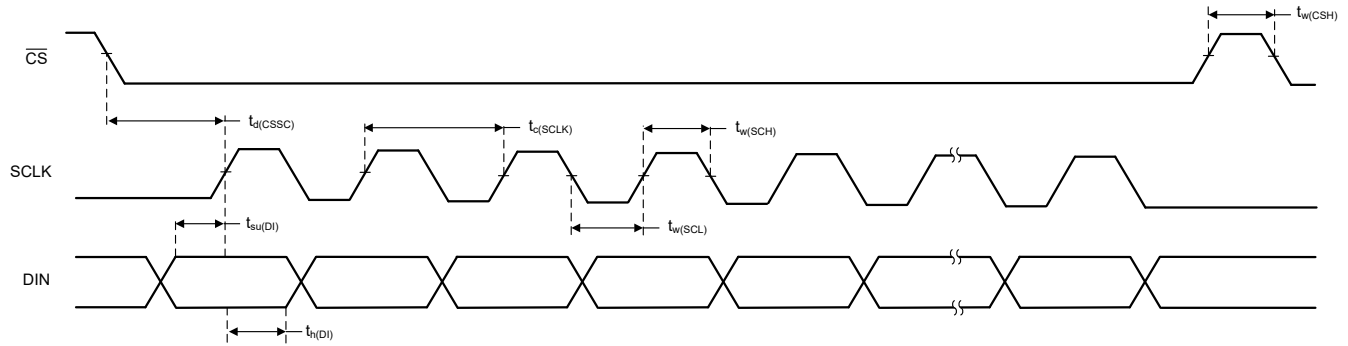

6-2. Serial Interface Timing Requirements

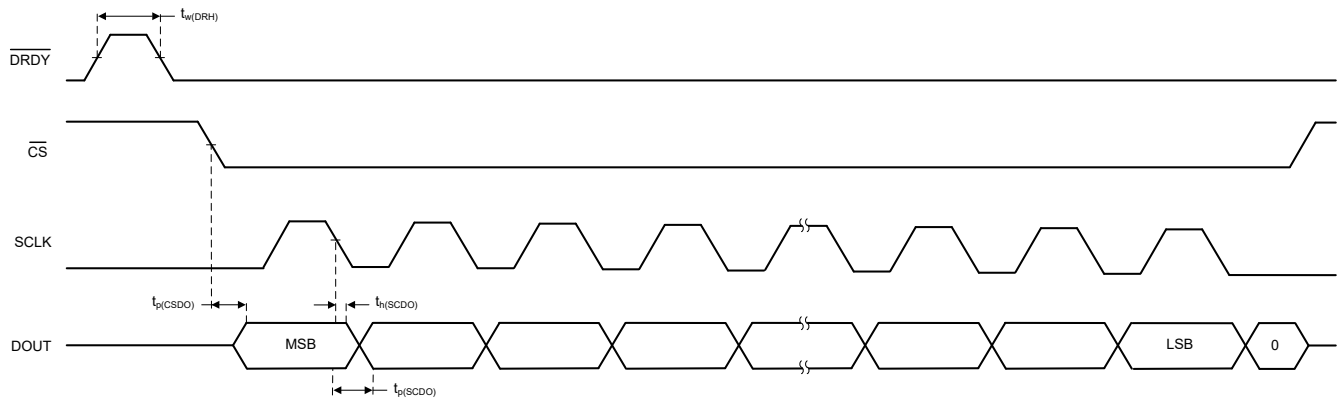

6-3. Serial Interface Switching Characteristics

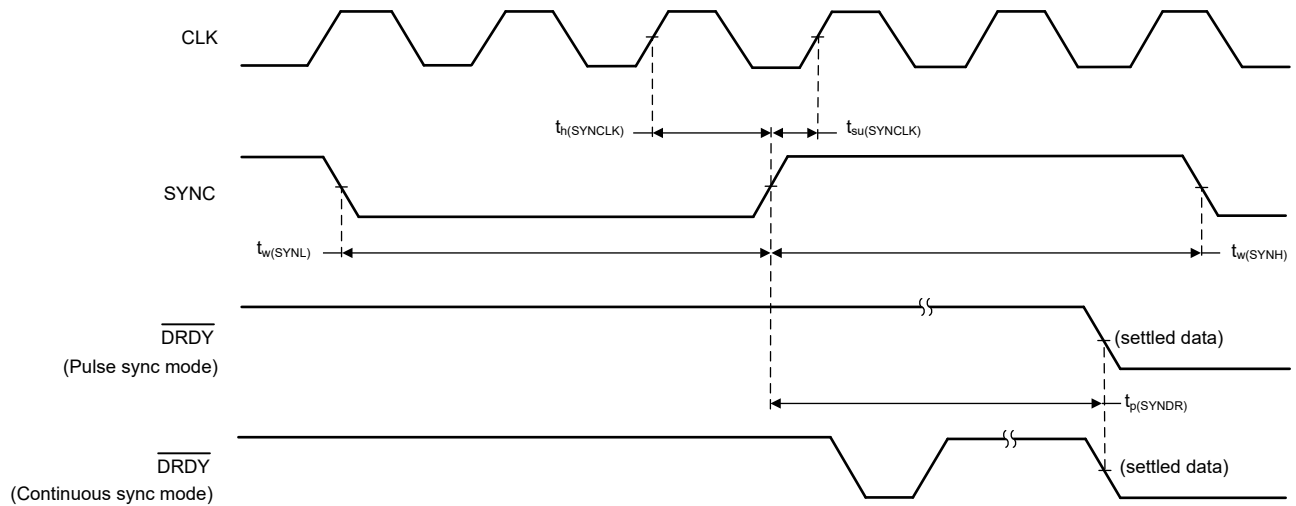

6-4. SYNC Timing Requirements and Switching Characteristics

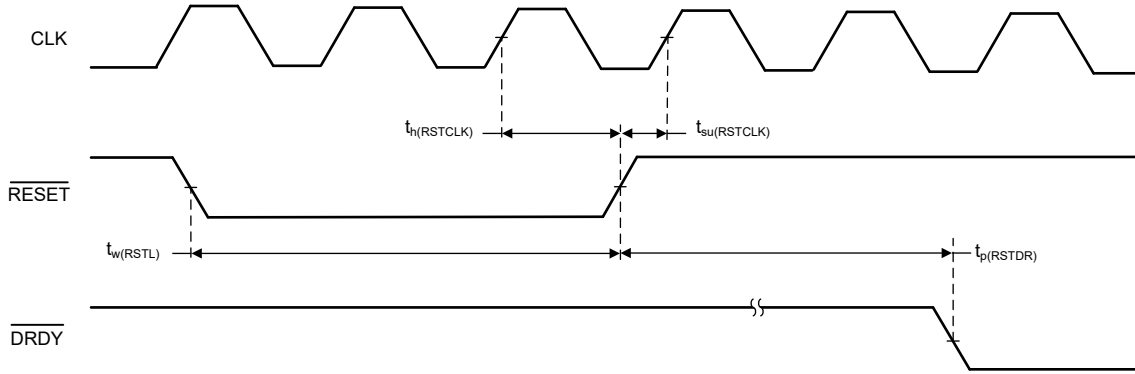

6-5. RESET Timing Requirements and Switching Characteristics

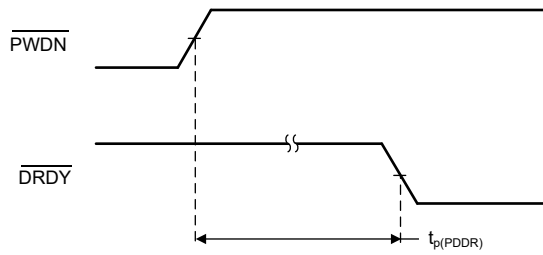

6-6. PWDN Switching Characteristics

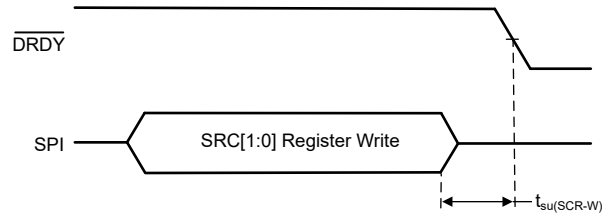

6-7. Sample Rate Converter Register-Write Timing Requirements

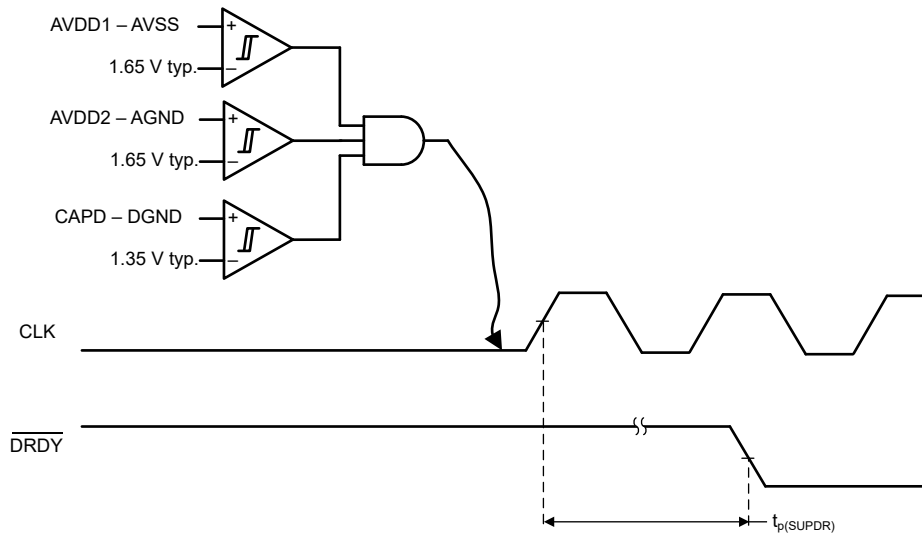

6-8. Power-Up Switching Characteristics

6.9 Typical Characteristics

at $T_A = 25^\circ\text{C}$, $AVDD1 = 5\text{ V}$, $AVSS = 0\text{ V}$, $AVDD2 = 2.5\text{ V}$, $IOVDD = 1.8\text{ V}$, $f_{\text{CLK}} = 8.192\text{ MHz}$ (4.096 MHz low-power mode), $V_{\text{REFP}} = 4.096\text{ V}$, $V_{\text{REFN}} = 0\text{ V}$, $\text{PGA gain} = 1$, $V_{\text{CM}} = 2.5\text{ V}$, $f_{\text{DATA}} = 500\text{ SPS}$ (unless otherwise noted)

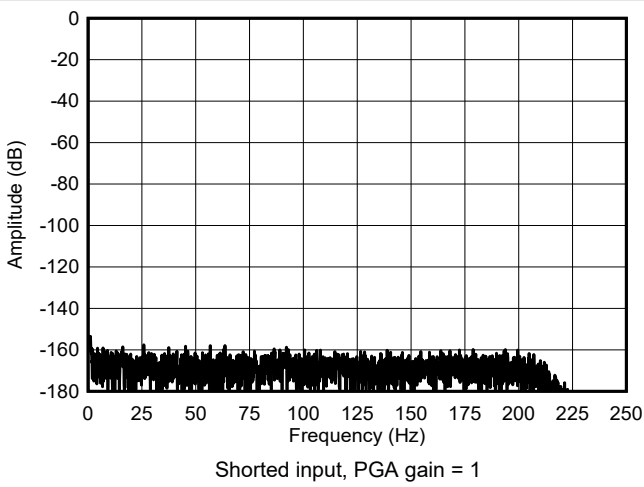

Figure 6-9. High-Power Mode FFT Spectrum

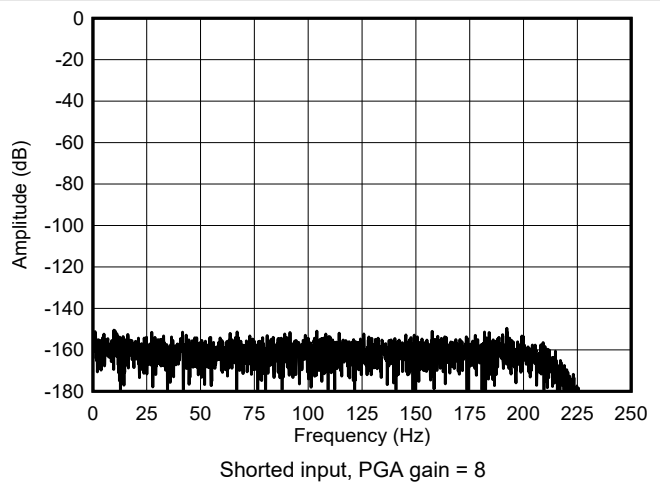

Figure 6-10. High-Power Mode FFT Spectrum

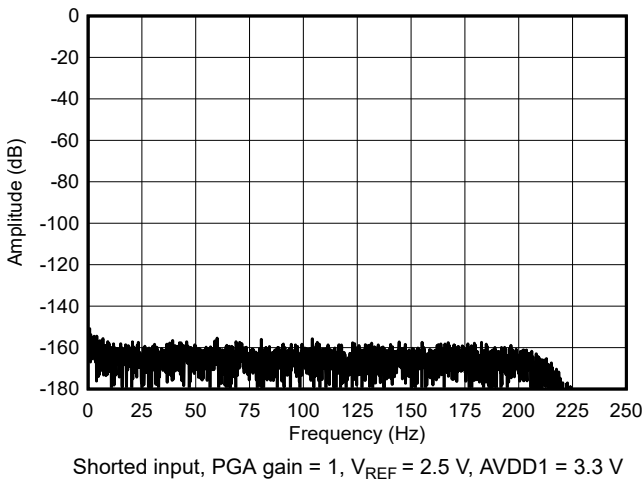

Figure 6-11. High-Power Mode FFT Spectrum

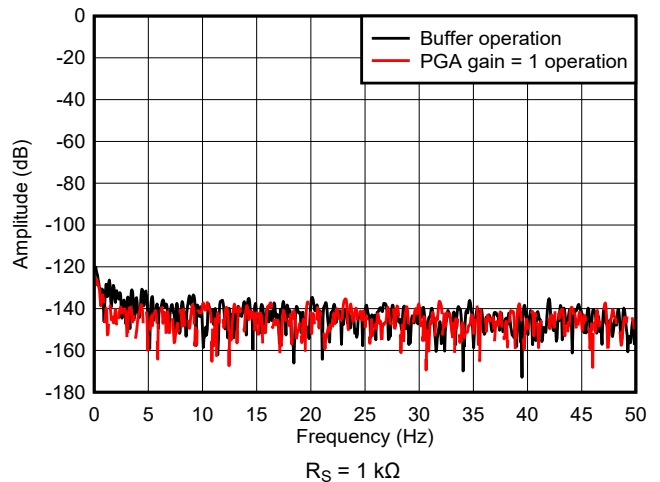

Figure 6-12. High-Power Mode FFT Spectrum

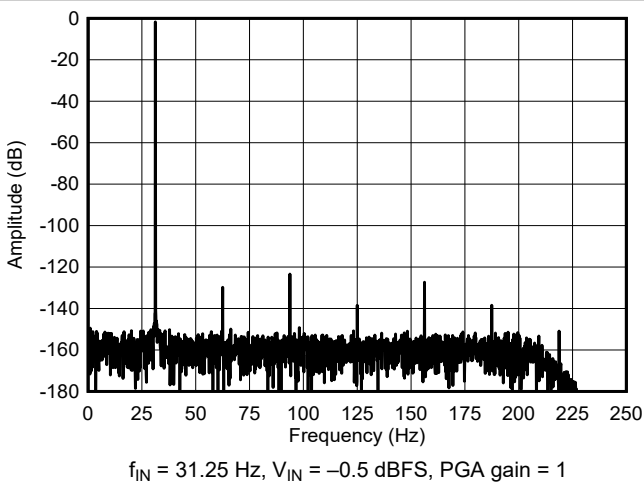

Figure 6-13. High-Power Mode FFT Spectrum

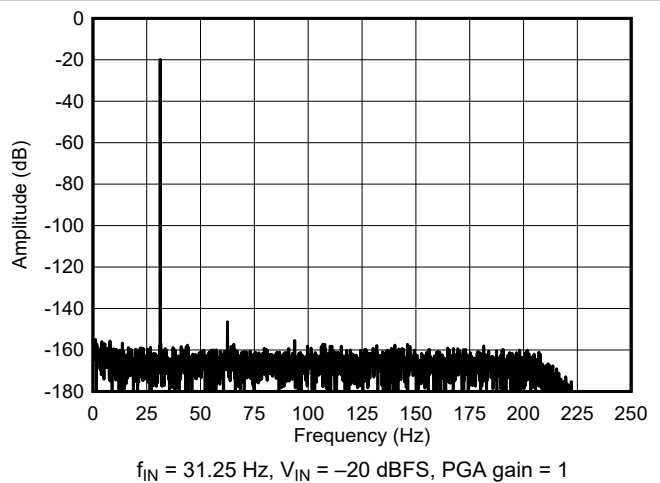

Figure 6-14. High-Power Mode FFT Spectrum

6.9 Typical Characteristics (continued)

at $T_A = 25^\circ\text{C}$, $AVDD1 = 5\text{ V}$, $AVSS = 0\text{ V}$, $AVDD2 = 2.5\text{ V}$, $IOVDD = 1.8\text{ V}$, $f_{\text{CLK}} = 8.192\text{ MHz}$ (4.096 MHz low-power mode), $V_{\text{REFP}} = 4.096\text{ V}$, $V_{\text{REFN}} = 0\text{ V}$, PGA gain = 1, $V_{\text{CM}} = 2.5\text{ V}$, $f_{\text{DATA}} = 500\text{ SPS}$ (unless otherwise noted)

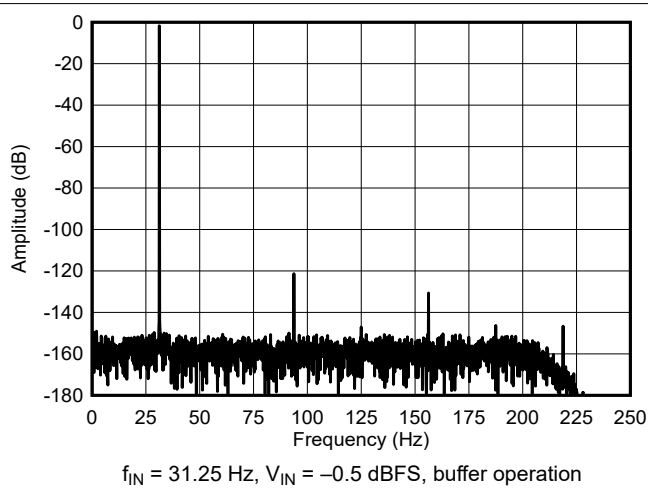

Figure 6-15. High-Power Mode FFT Spectrum

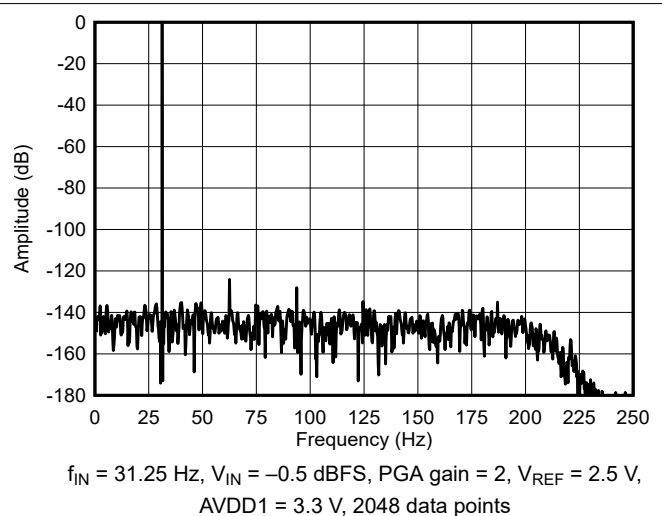

Figure 6-16. High-Power Mode FFT Spectrum

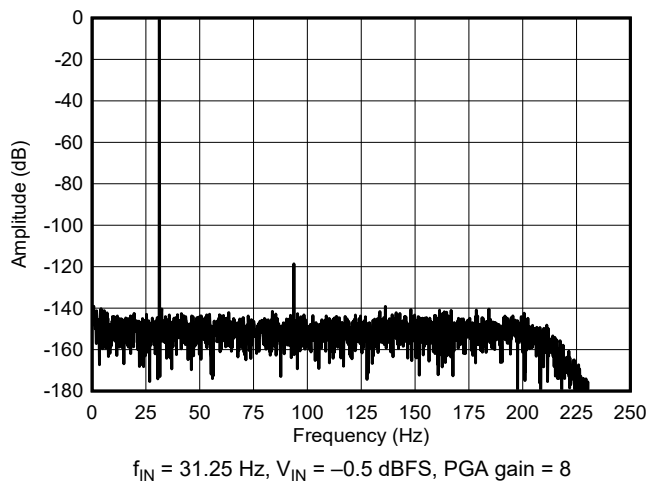

Figure 6-17. High-Power Mode FFT Spectrum

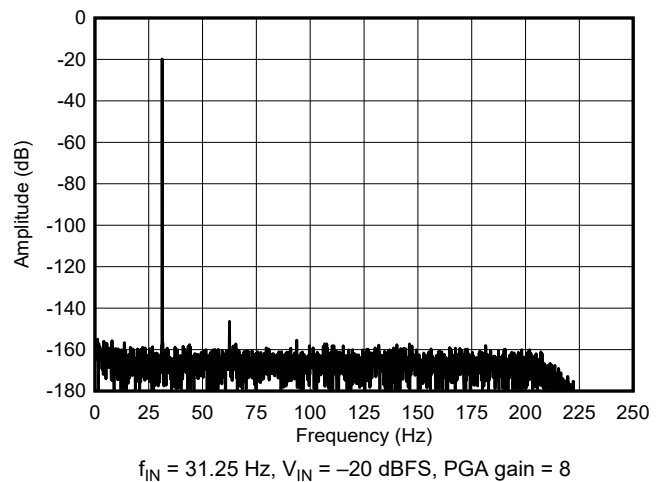

Figure 6-18. High-Power Mode FFT Spectrum

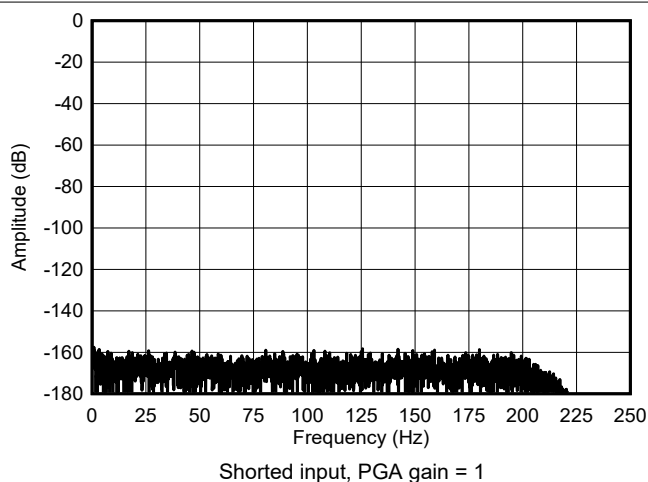

Figure 6-19. Mid-Power Mode FFT Spectrum

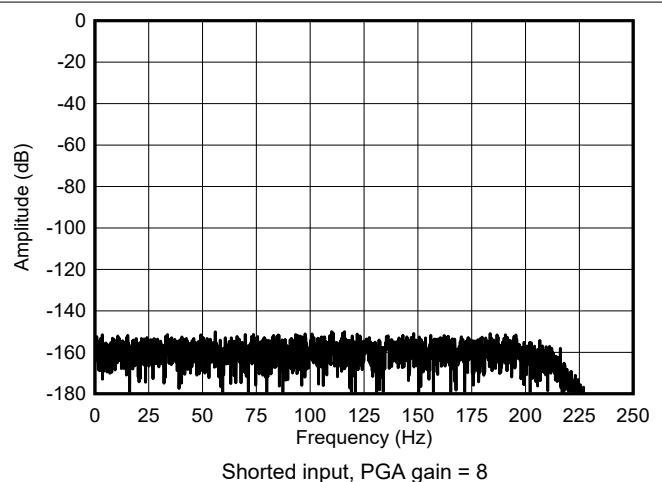
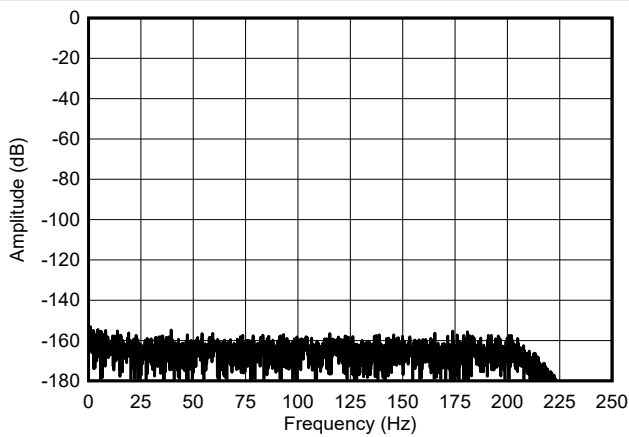

Figure 6-20. Mid-Power Mode FFT Spectrum

6.9 Typical Characteristics (continued)

at $T_A = 25^\circ\text{C}$, $AVDD1 = 5\text{ V}$, $AVSS = 0\text{ V}$, $AVDD2 = 2.5\text{ V}$, $IOVDD = 1.8\text{ V}$, $f_{\text{CLK}} = 8.192\text{ MHz}$ (4.096 MHz low-power mode), $V_{\text{REFP}} = 4.096\text{ V}$, $V_{\text{REFN}} = 0\text{ V}$, PGA gain = 1, $V_{\text{CM}} = 2.5\text{ V}$, $f_{\text{DATA}} = 500\text{ SPS}$ (unless otherwise noted)



Shorted input, PGA gain = 1, $V_{\text{REF}} = 2.5\text{ V}$, $AVDD1 = 3.3\text{ V}$

6-21. Mid-Power Mode FFT Spectrum

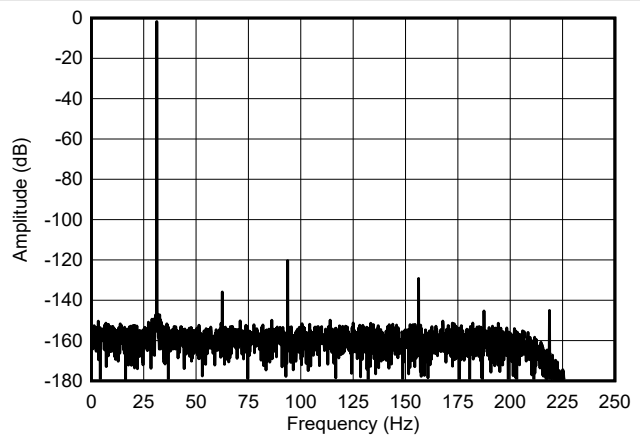

$f_{\text{IN}} = 31.25\text{ Hz}$, $V_{\text{IN}} = -0.5\text{ dBFS}$, PGA gain = 1

6-22. Mid-Power Mode FFT Spectrum

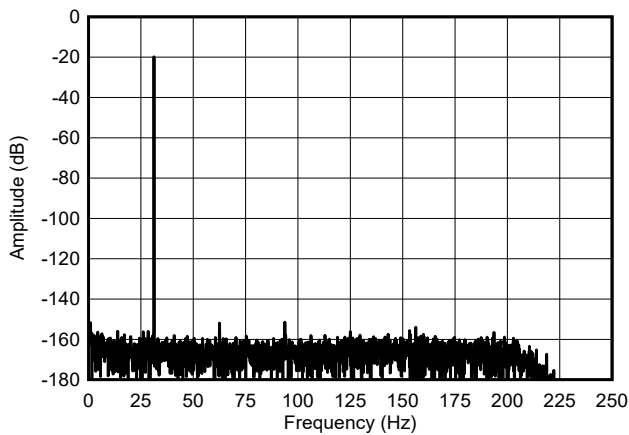

$f_{\text{IN}} = 31.25\text{ Hz}$, $V_{\text{IN}} = -20\text{ dBFS}$, PGA gain = 1

6-23. Mid-Power Mode FFT Spectrum

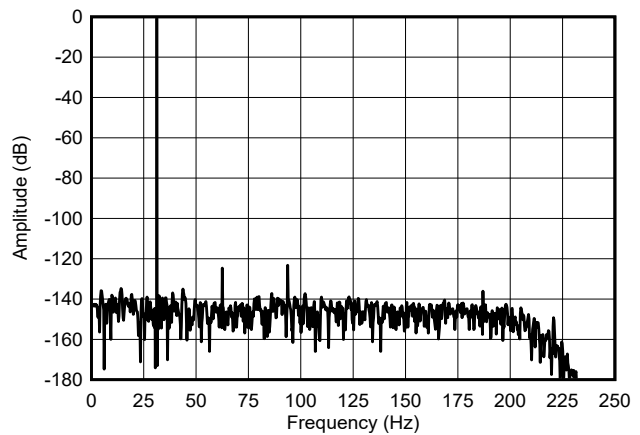

$f_{\text{IN}} = 31.25\text{ Hz}$, $V_{\text{IN}} = -0.5\text{ dBFS}$, PGA gain = 2, $V_{\text{REF}} = 2.5\text{ V}$, $AVDD1 = 3.3\text{ V}$, 2048 data points

6-24. Mid-Power Mode FFT Spectrum

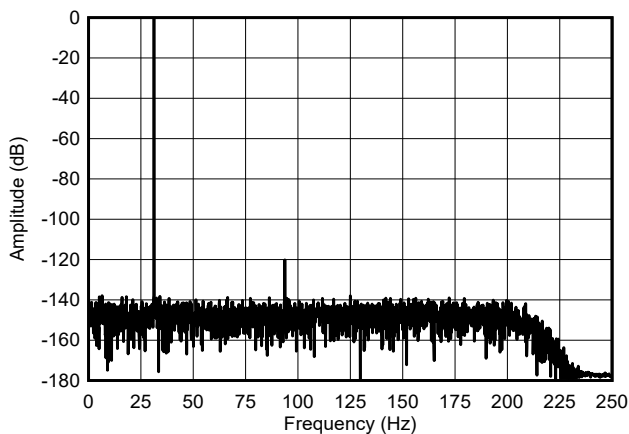

$f_{\text{IN}} = 31.25\text{ Hz}$, $V_{\text{IN}} = -0.5\text{ dBFS}$, PGA gain = 8

6-25. Mid-Power Mode FFT Spectrum

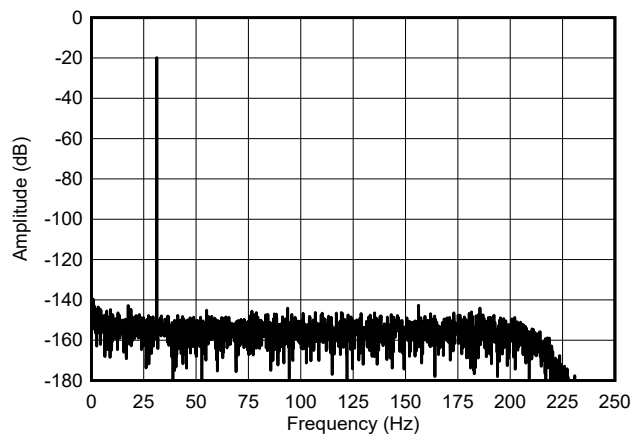

$f_{\text{IN}} = 31.25\text{ Hz}$, $V_{\text{IN}} = -20\text{ dBFS}$, PGA gain = 8

6-26. Mid-Power Mode FFT Spectrum

6.9 Typical Characteristics (continued)

at $T_A = 25^\circ\text{C}$, $AVDD1 = 5\text{ V}$, $AVSS = 0\text{ V}$, $AVDD2 = 2.5\text{ V}$, $IOVDD = 1.8\text{ V}$, $f_{\text{CLK}} = 8.192\text{ MHz}$ (4.096 MHz low-power mode), $V_{\text{REFP}} = 4.096\text{ V}$, $V_{\text{REFN}} = 0\text{ V}$, PGA gain = 1, $V_{\text{CM}} = 2.5\text{ V}$, $f_{\text{DATA}} = 500\text{ SPS}$ (unless otherwise noted)

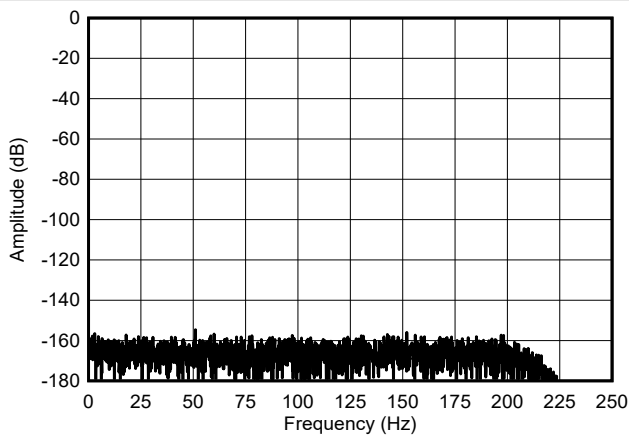

6-27. Low-Power Mode FFT Spectrum

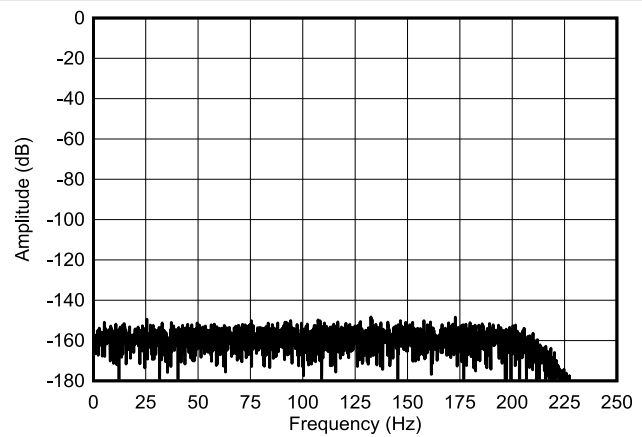

6-28. Low-Power Mode FFT Spectrum

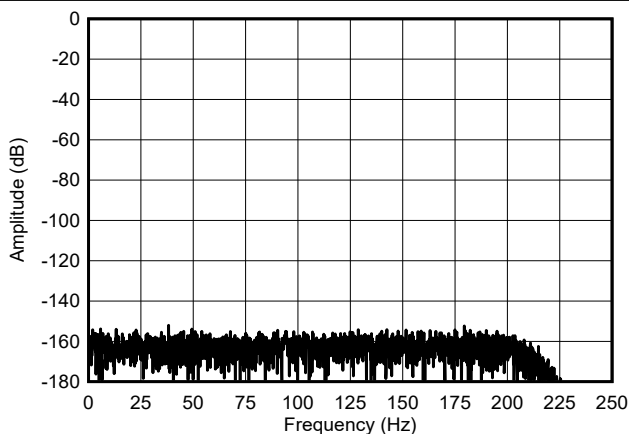

6-29. Low-Power Mode FFT Spectrum

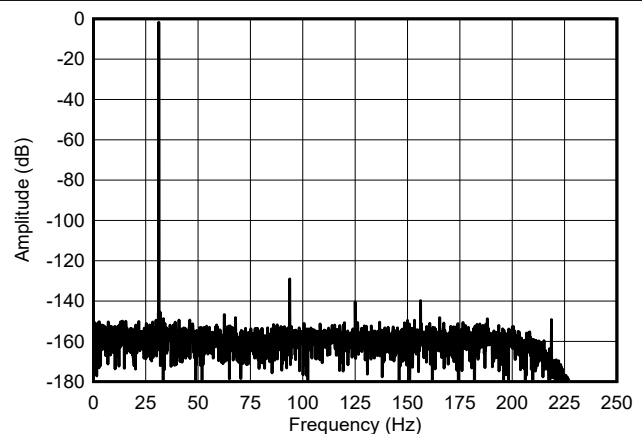

6-30. Low-Power Mode FFT Spectrum

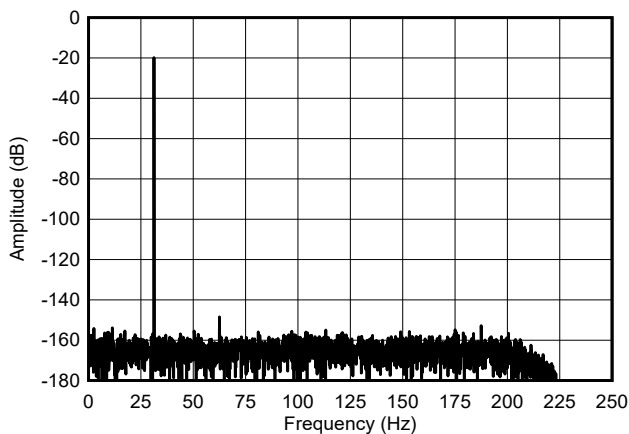

6-31. Low-Power Mode FFT Spectrum

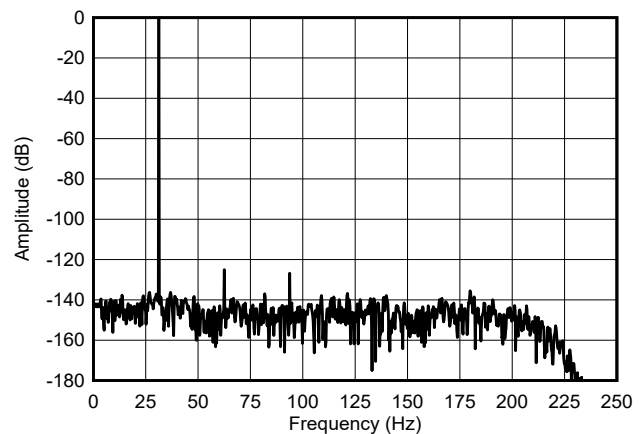

6-32. Low-Power Mode FFT Spectrum

6.9 Typical Characteristics (continued)

at $T_A = 25^\circ\text{C}$, $AVDD1 = 5\text{ V}$, $AVSS = 0\text{ V}$, $AVDD2 = 2.5\text{ V}$, $IOVDD = 1.8\text{ V}$, $f_{\text{CLK}} = 8.192\text{ MHz}$ (4.096 MHz low-power mode), $V_{\text{REFP}} = 4.096\text{ V}$, $V_{\text{REFN}} = 0\text{ V}$, PGA gain = 1, $V_{\text{CM}} = 2.5\text{ V}$, $f_{\text{DATA}} = 500\text{ SPS}$ (unless otherwise noted)

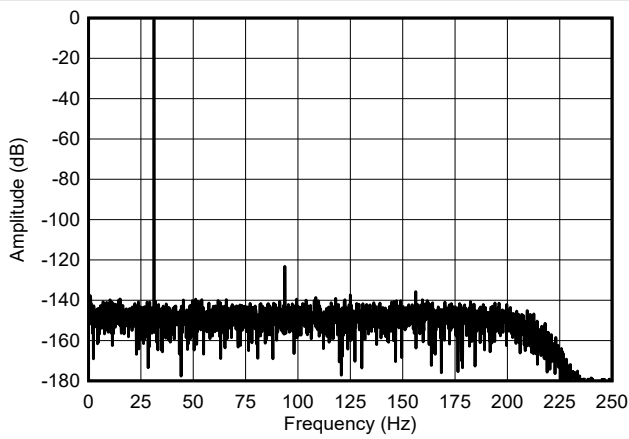

$f_{\text{IN}} = 31.25\text{ Hz}$, $V_{\text{IN}} = -0.5\text{ dBFS}$, PGA gain = 8

6-33. Low-Power Mode FFT Spectrum

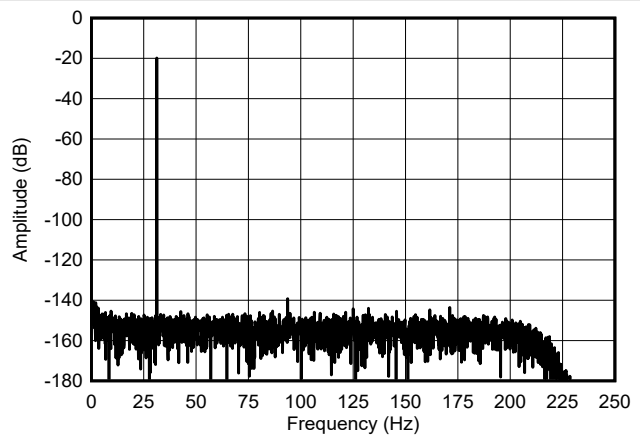

$f_{\text{IN}} = 31.25\text{ Hz}$, $V_{\text{IN}} = -20\text{ dBFS}$, PGA gain = 8

6-34. Low-Power Mode FFT Spectrum

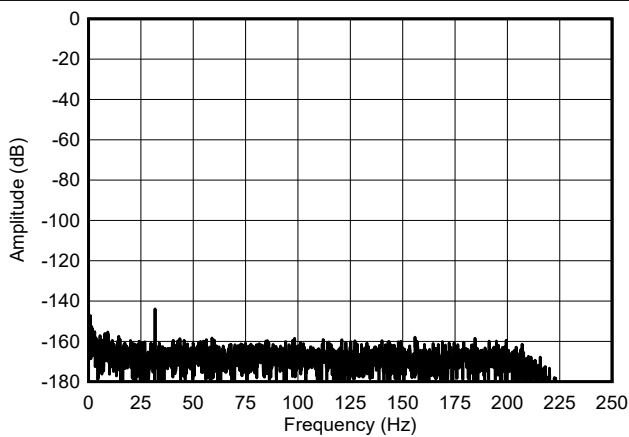

$\text{AIN1} = f_{\text{IN}} = 31.25\text{ Hz}$, -0.5-dBFS signal, $\text{AIN2} = \text{shorted}$

6-35. Channel-to-Channel Crosstalk

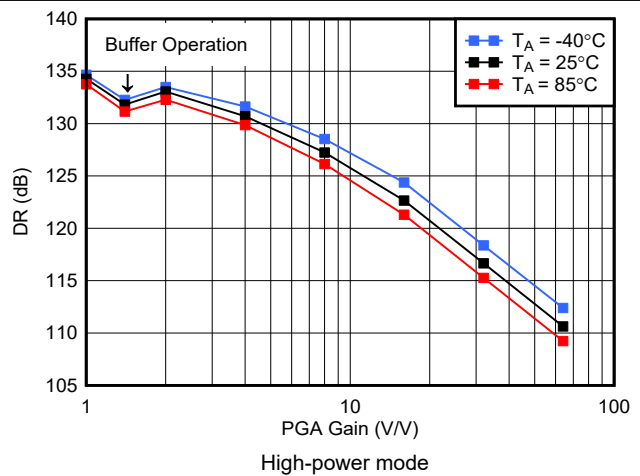

6-36. Dynamic Range vs PGA Gain

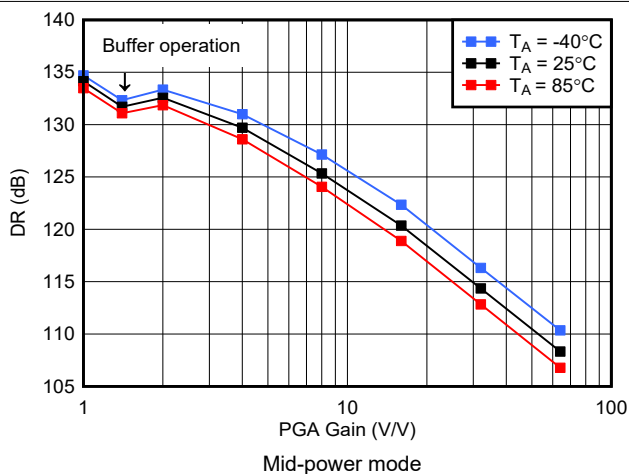

6-37. Dynamic Range vs PGA Gain

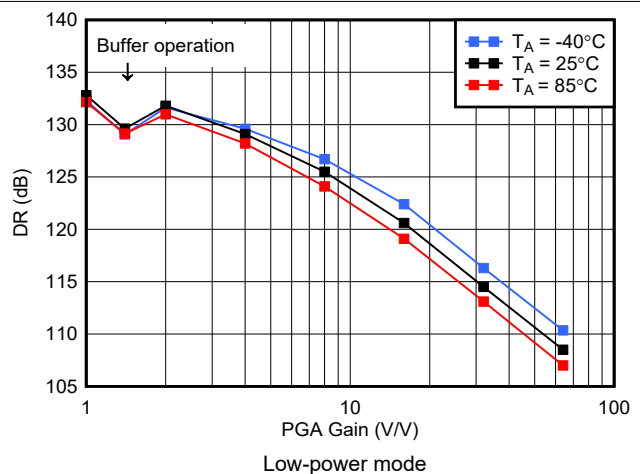

6-38. Dynamic Range vs PGA Gain

6.9 Typical Characteristics (continued)

at $T_A = 25^\circ\text{C}$, $AVDD1 = 5\text{ V}$, $AVSS = 0\text{ V}$, $AVDD2 = 2.5\text{ V}$, $IOVDD = 1.8\text{ V}$, $f_{\text{CLK}} = 8.192\text{ MHz}$ (4.096 MHz low-power mode), $V_{\text{REFP}} = 4.096\text{ V}$, $V_{\text{REFN}} = 0\text{ V}$, PGA gain = 1, $V_{\text{CM}} = 2.5\text{ V}$, $f_{\text{DATA}} = 500\text{ SPS}$ (unless otherwise noted)

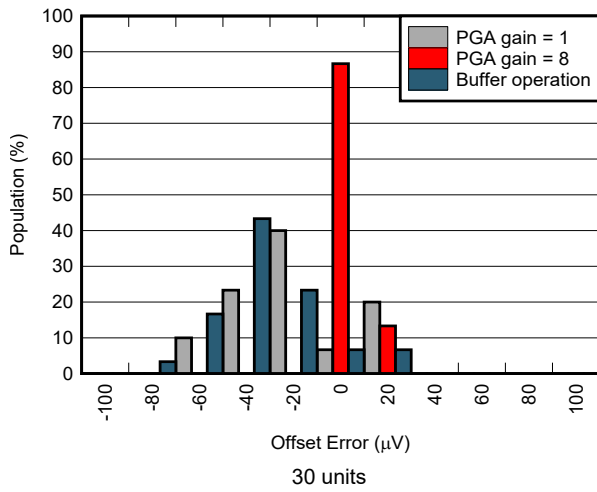

6-39. Offset Error Distribution

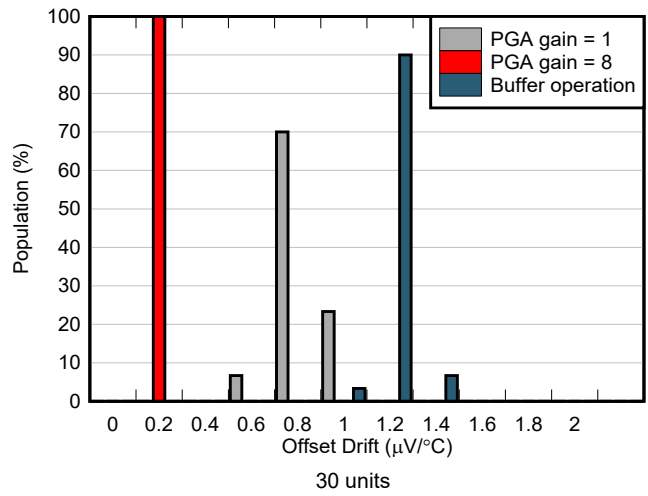

6-40. Offset Drift Distribution

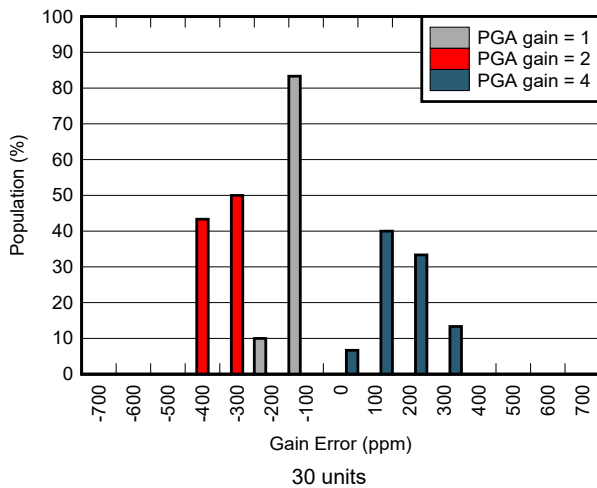

6-41. Gain Error Distribution

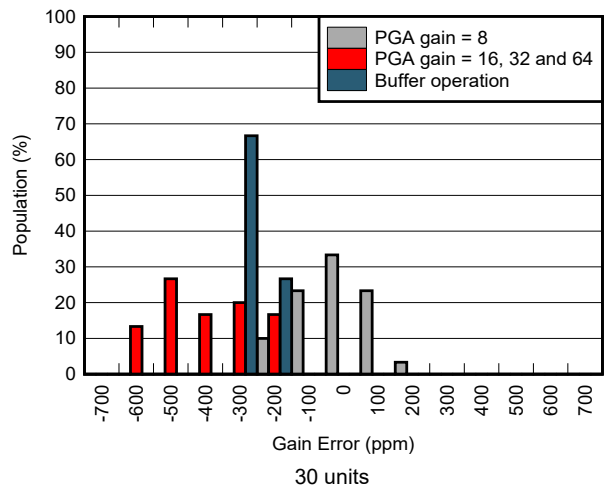

6-42. Gain Error Distribution

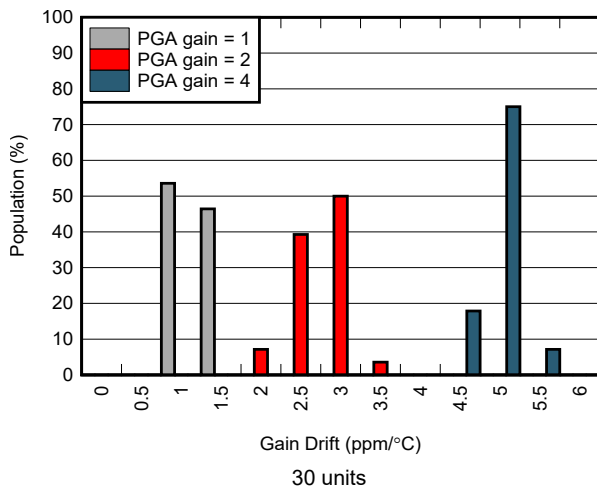

6-43. Gain Drift Distribution

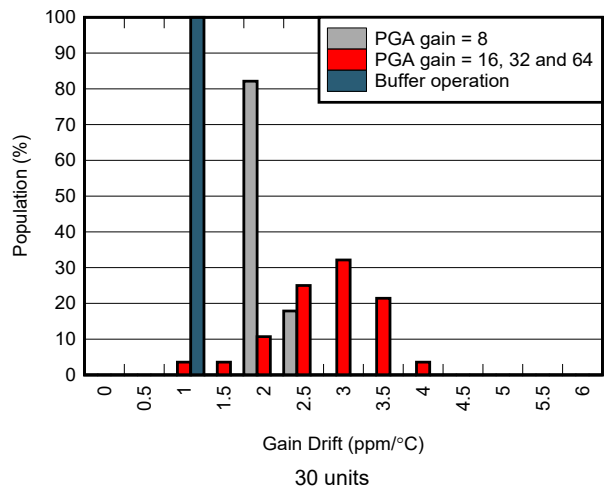

6-44. Gain Drift Distribution

6.9 Typical Characteristics (continued)

at $T_A = 25^\circ\text{C}$, $AVDD1 = 5\text{ V}$, $AVSS = 0\text{ V}$, $AVDD2 = 2.5\text{ V}$, $IOVDD = 1.8\text{ V}$, $f_{\text{CLK}} = 8.192\text{ MHz}$ (4.096 MHz low-power mode), $V_{\text{REFP}} = 4.096\text{ V}$, $V_{\text{REFN}} = 0\text{ V}$, PGA gain = 1, $V_{\text{CM}} = 2.5\text{ V}$, $f_{\text{DATA}} = 500\text{ SPS}$ (unless otherwise noted)

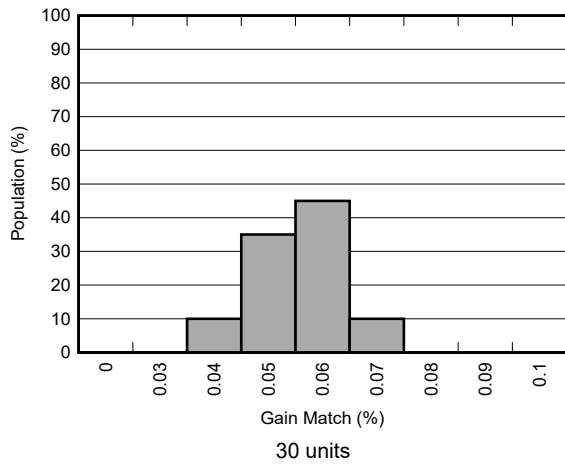

6-45. Gain Match Distribution

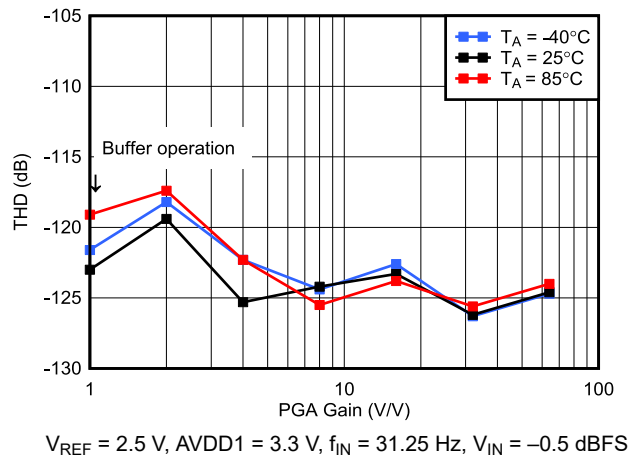

6-46. High-Power Mode THD vs PGA Gain

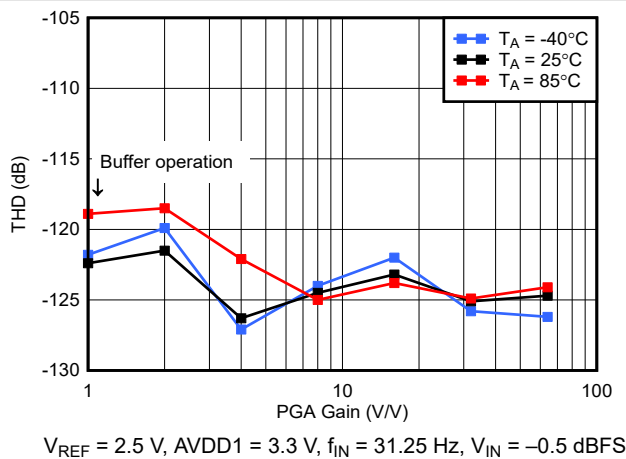

6-47. Mid-Power Mode THD vs PGA Gain

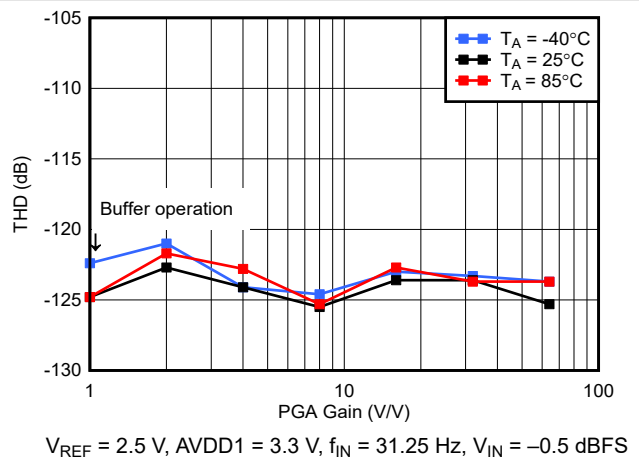

6-48. Low-Power Mode THD vs PGA Gain

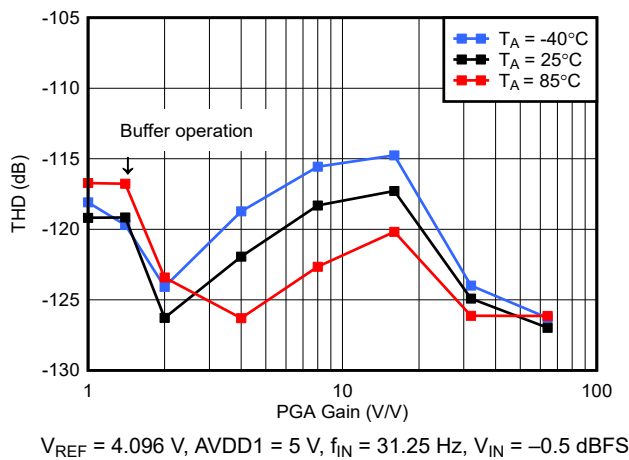

6-49. High-Power Mode THD vs PGA Gain

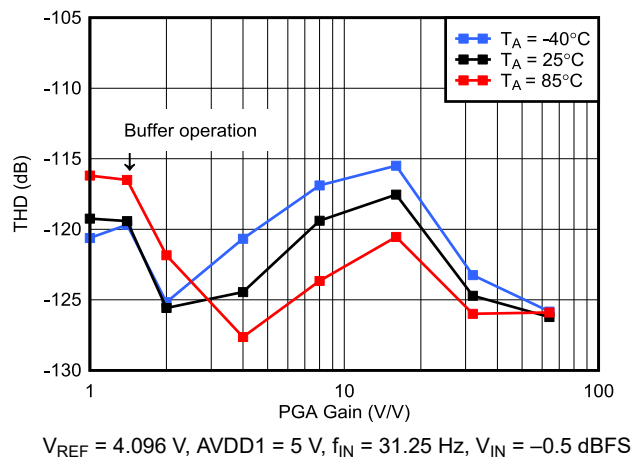

6-50. Mid-Power Mode THD vs PGA Gain

6.9 Typical Characteristics (continued)

at $T_A = 25^\circ\text{C}$, $AVDD1 = 5\text{ V}$, $AVSS = 0\text{ V}$, $AVDD2 = 2.5\text{ V}$, $IOVDD = 1.8\text{ V}$, $f_{\text{CLK}} = 8.192\text{ MHz}$ (4.096 MHz low-power mode), $V_{\text{REFP}} = 4.096\text{ V}$, $V_{\text{REFN}} = 0\text{ V}$, PGA gain = 1, $V_{\text{CM}} = 2.5\text{ V}$, $f_{\text{DATA}} = 500\text{ SPS}$ (unless otherwise noted)

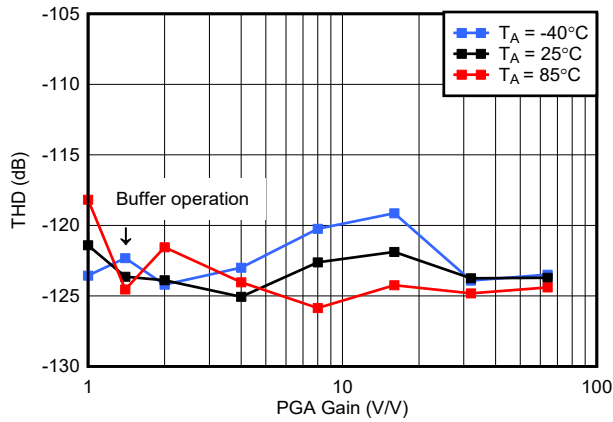

$V_{\text{REF}} = 4.096\text{ V}$, $AVDD1 = 5\text{ V}$, $f_{\text{IN}} = 31.25\text{ Hz}$, $V_{\text{IN}} = -0.5\text{ dBFS}$

6-51. Low-Power Mode THD vs PGA Gain

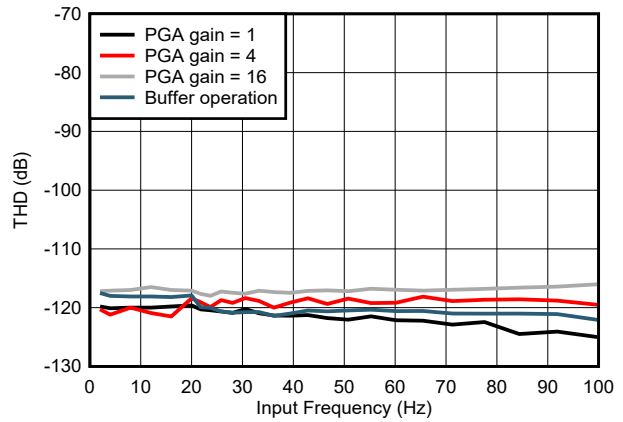

$V_{\text{REF}} = 4.096\text{ V}$, $AVDD1 = 5\text{ V}$, $f_{\text{IN}} = 31.25\text{ Hz}$, $V_{\text{IN}} = -0.5\text{ dBFS}$

6-52. High- and Mid-Power Mode THD vs Input Frequency

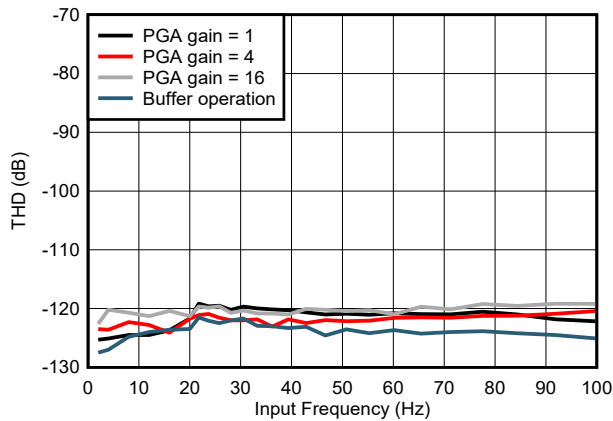

$V_{\text{REF}} = 4.096\text{ V}$, $AVDD1 = 5\text{ V}$, $f_{\text{IN}} = 31.25\text{ Hz}$, $V_{\text{IN}} = -0.5\text{ dBFS}$

6-53. Low-Power Mode THD vs Input Frequency

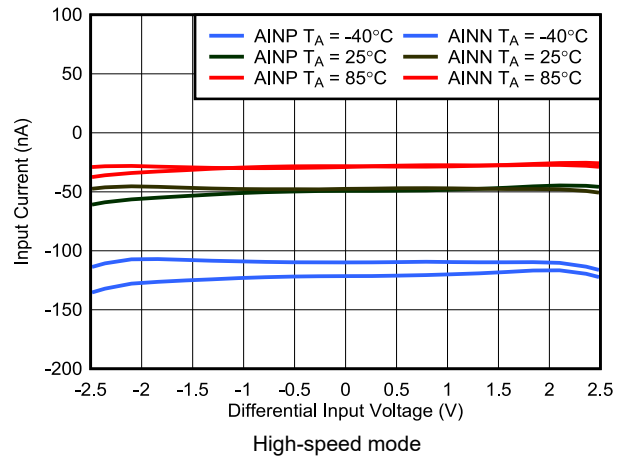

6-54. PGA Input Current vs Input Voltage

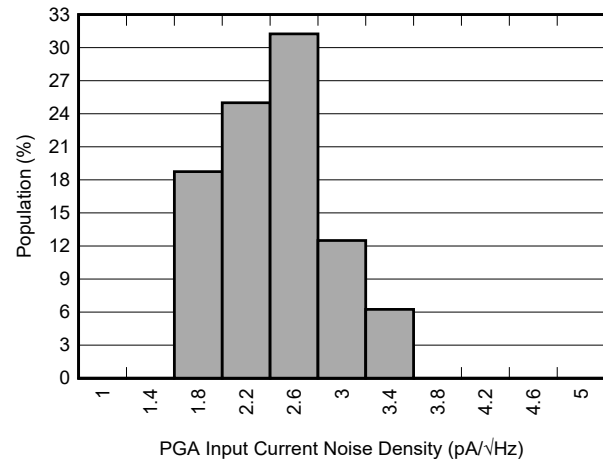

6-55. PGA Input Current Noise Distribution

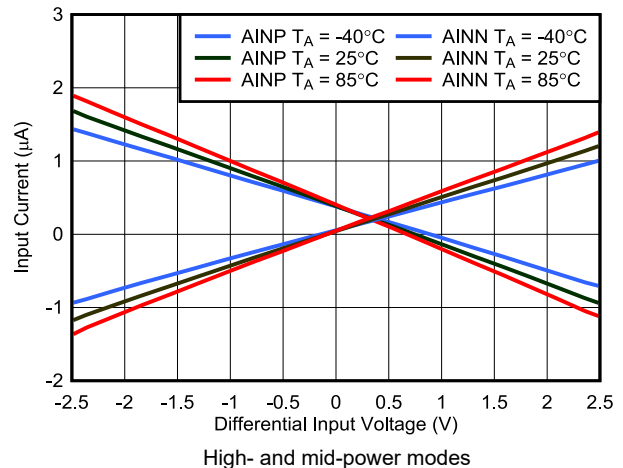

6-56. Buffer Input Current vs Input Voltage

6.9 Typical Characteristics (continued)

at $T_A = 25^\circ\text{C}$, $AVDD1 = 5\text{ V}$, $AVSS = 0\text{ V}$, $AVDD2 = 2.5\text{ V}$, $IOVDD = 1.8\text{ V}$, $f_{\text{CLK}} = 8.192\text{ MHz}$ (4.096 MHz low-power mode), $V_{\text{REFP}} = 4.096\text{ V}$, $V_{\text{REFN}} = 0\text{ V}$, PGA gain = 1, $V_{\text{CM}} = 2.5\text{ V}$, $f_{\text{DATA}} = 500\text{ SPS}$ (unless otherwise noted)

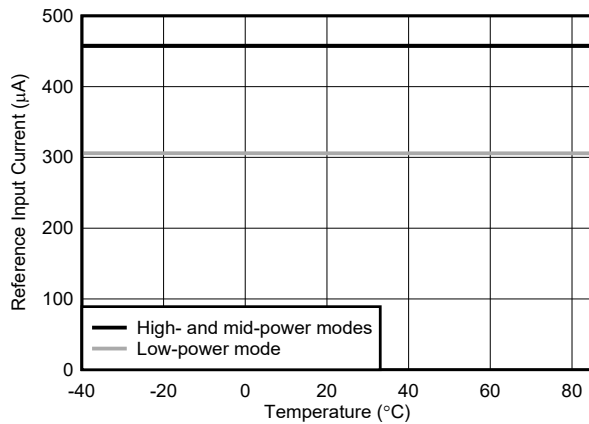

6-57. Reference Input Current vs Temperature

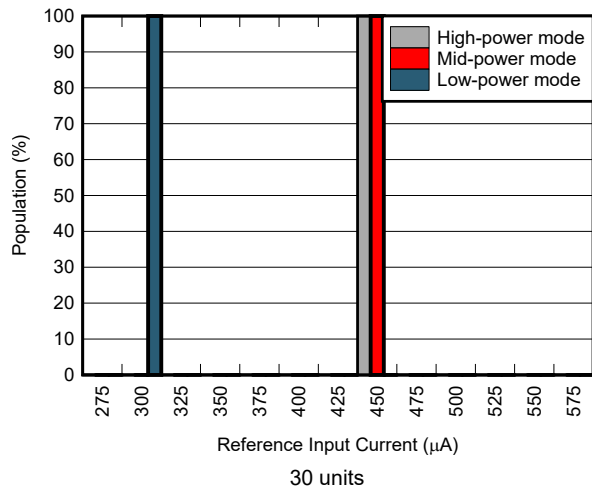

6-58. Reference Input Current Distribution

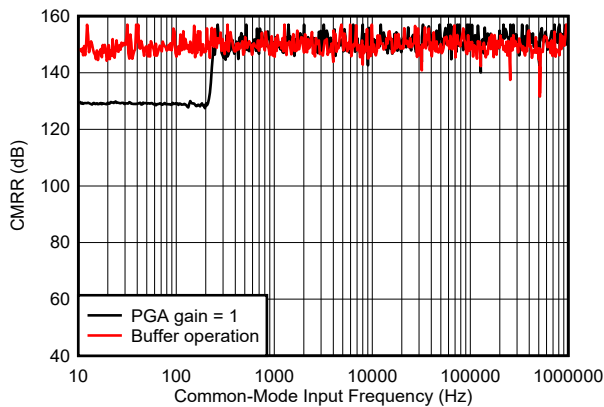

6-59. CMRR vs Common-Mode Input Frequency

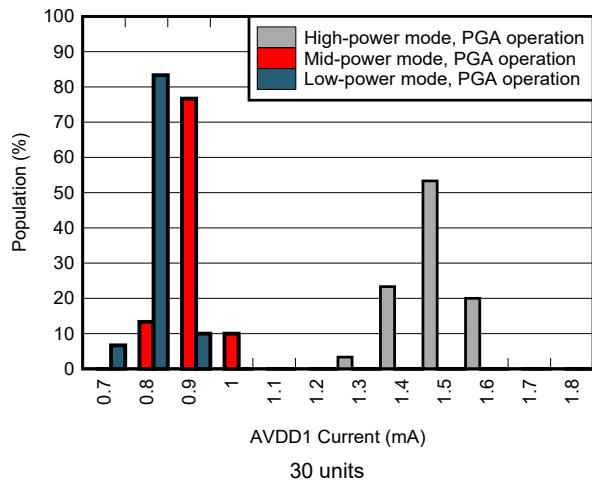

6-60. AVDD1 Current Distribution

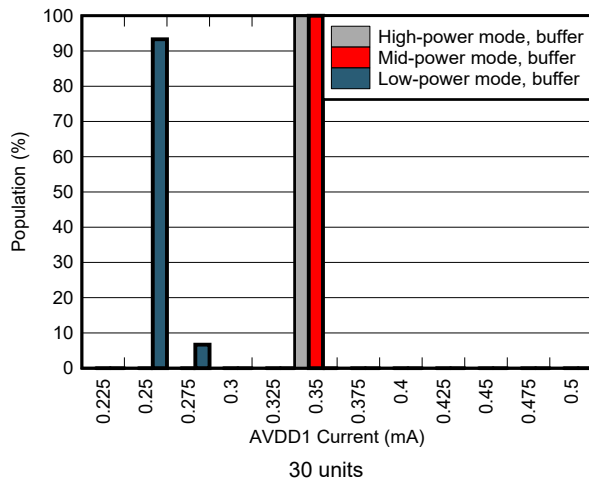

6-61. AVDD1 Current Distribution

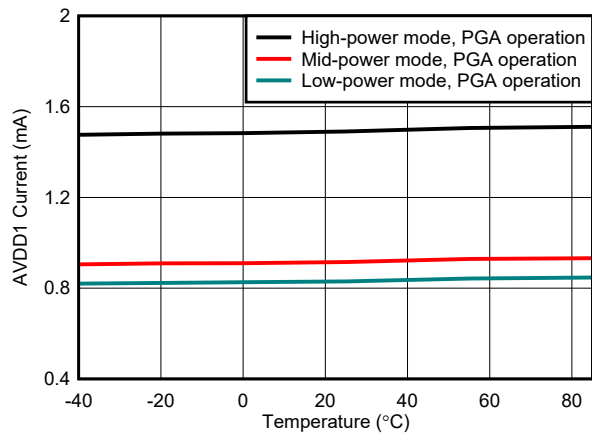

6-62. AVDD1 Current vs Temperature

6.9 Typical Characteristics (continued)

at $T_A = 25^\circ\text{C}$, $AVDD1 = 5\text{ V}$, $AVSS = 0\text{ V}$, $AVDD2 = 2.5\text{ V}$, $IOVDD = 1.8\text{ V}$, $f_{\text{CLK}} = 8.192\text{ MHz}$ (4.096 MHz low-power mode), $V_{\text{REFP}} = 4.096\text{ V}$, $V_{\text{REFN}} = 0\text{ V}$, PGA gain = 1, $V_{\text{CM}} = 2.5\text{ V}$, $f_{\text{DATA}} = 500\text{ SPS}$ (unless otherwise noted)

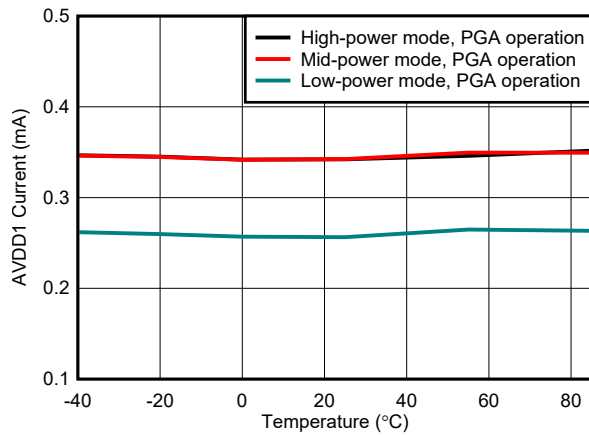

6-63. AVDD1 Current vs Temperature

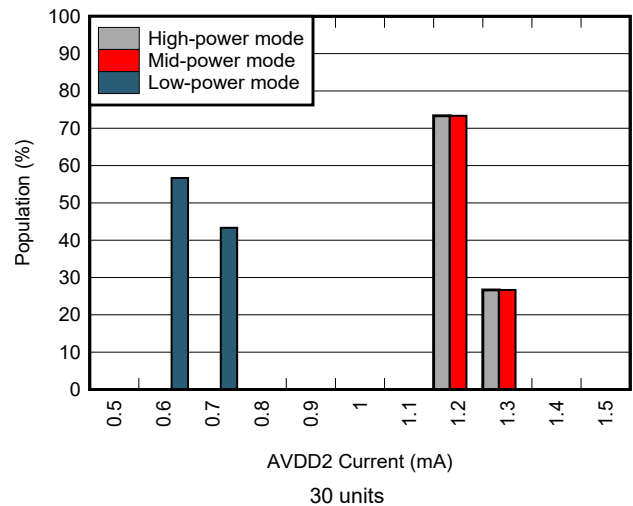

6-64. AVDD2 Current Distribution

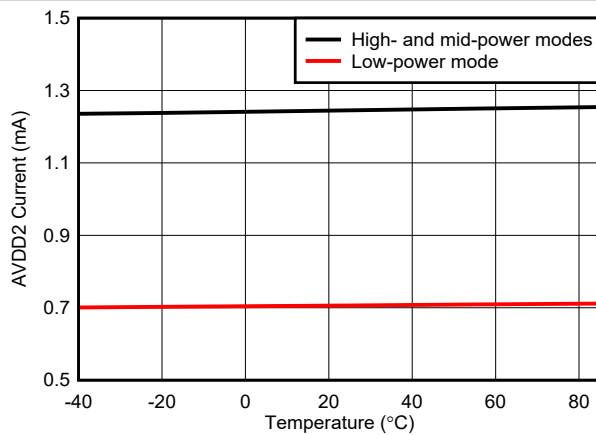

6-65. AVDD2 Current vs Temperature

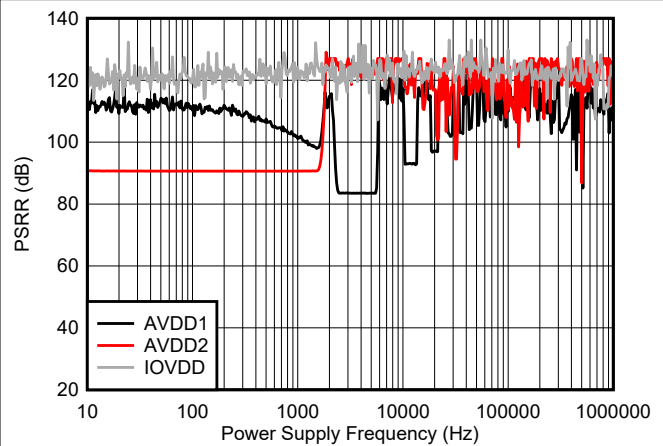

6-66. PSRR vs Power-Supply Frequency

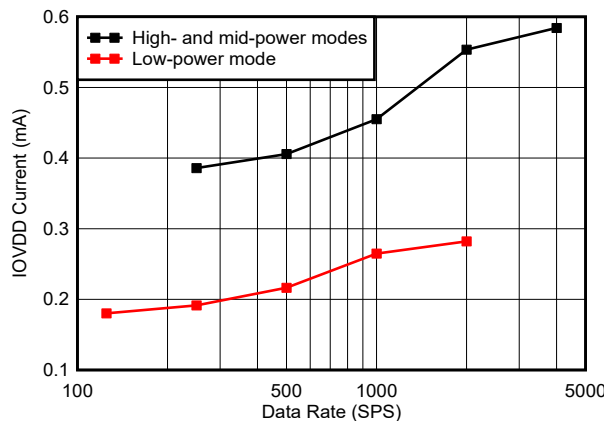

6-67. IOVDD Current vs Data Rate

7 Parameter Measurement Information

7.1 Noise Performance

The ADS1285 is a 32-bit ADC providing three power-resolution modes, allowing optimization of noise performance versus device power consumption. The four determining factors of noise performance are the power mode, output data rate, PGA gain setting, and reference voltage selection. The high-power mode operates the PGA and modulator sampling rate at the highest capacity for best overall noise performance. The mid-power mode scales down the PGA quiescent current to reduce power consumption but results in increased PGA noise. The low-power mode reduces both the modulator sampling rate and PGA quiescent current. The result is the low-power mode has the lowest power consumption but the highest level of overall noise.

For all power modes, decreasing the output data rate reduces signal bandwidth, and therefore decreases total noise. Increasing the PGA gain reduces noise when noise is referred to the input. Dynamic range performance decreases when PGA gain is increased because the ratio of input voltage range to input-referred noise also decreases.

Noise performance also depends on the reference voltage. Operation with $V_{REF} = 4.096\text{ V}$ or 5 V provides the best noise performance. Operation with $V_{REF} = 2.5\text{ V}$ (required when operating $AVDD1 = 3.3\text{ V}$) reduces noise performance.

Dynamic range and input noise are equivalent parameters that describe the available resolution of the ADC. 式 1 derives dynamic range from the input-referred noise data:

$$\text{Dynamic Range (dB)} = 20 \times \log \left[\frac{1.768\text{ V}}{\text{Gain} \times e_n} \right] \quad (1)$$

where:

- e_n = Input-referred voltage noise (RMS)

图 7-1 and 图 7-2 show dynamic range performance at $f_{DATA} = 500\text{ SPS}$ for operation with $V_{REF} = 4.096\text{ V}$ and $V_{REF} = 2.5\text{ V}$.



图 7-1. Dynamic Range vs PGA Gain



图 7-2. Dynamic Range vs PGA Gain

表 7-1 through 表 7-3 list dynamic range and input-referred noise performance with $V_{REF} = 4.096\text{ V}$ and $AVDD1 = 5\text{ V}$, tested with input source resistance (R_S) = $0\ \Omega$. 表 7-4 through 表 7-6 list dynamic range and input noise performance with $V_{REF} = 2.5\text{ V}$ and $AVDD1 = 3.3\text{ V}$, tested with $R_S = 0\ \Omega$. Noise data are at $T_A = 25^\circ\text{C}$ and are representative of typical ADC performance. The data are the standard deviation of 4096 consecutive ADC conversion results with the ADC inputs shorted, measured over the $0.413 \times f_{DATA}$ bandwidth. Because of the statistical nature of noise, repeated measurements can yield varying noise performance results.

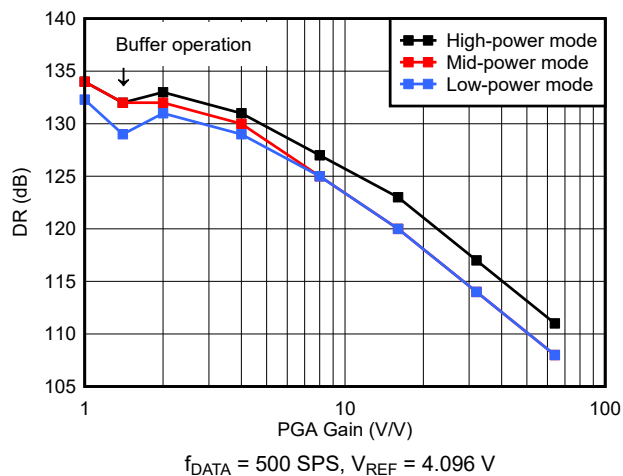
表 7-1. High-Power Mode Noise Performance ($V_{REF} = 4.096\text{ V}$, $AVDD1 = 5\text{ V}$, $R_S = 0\ \Omega$)

GAIN	MODE	DYNAMIC RANGE (dB)					e_n , INPUT-REFERRED NOISE (μV_{RMS})				
		f_{DATA}					f_{DATA}				
		250	500	1000	2000	4000	250	500	1000	2000	4000
1	Buffer	135	132	129	126	123	0.31	0.44	0.63	0.89	1.25
1	PGA	137	134	131	128	125	0.25	0.35	0.50	0.70	0.99
2	PGA	136	133	130	127	124	0.14	0.20	0.28	0.39	0.56
4	PGA	134	131	128	125	122	0.09	0.12	0.18	0.25	0.35
8	PGA	130	127	124	121	118	0.07	0.10	0.14	0.20	0.28
16	PGA	126	123	120	117	114	0.06	0.08	0.11	0.16	0.22
32	PGA	120	117	114	111	108	0.06	0.08	0.11	0.16	0.22
64	PGA	114	111	108	105	102	0.06	0.08	0.11	0.16	0.22

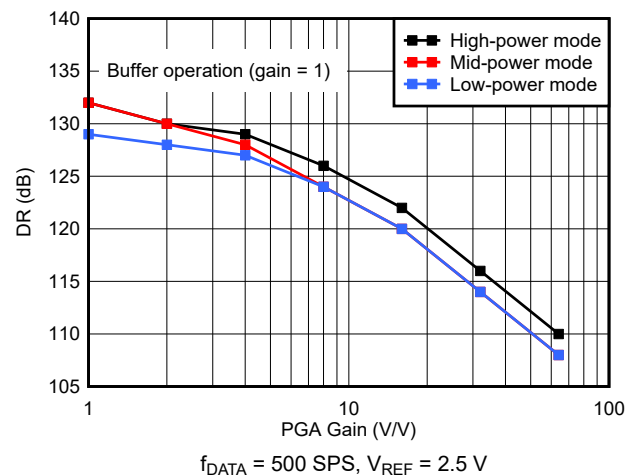
表 7-2. Mid-Power Mode Noise Performance ($V_{REF} = 4.096\text{ V}$, $AVDD1 = 5\text{ V}$, $R_S = 0\ \Omega$)

GAIN	MODE	DYNAMIC RANGE (dB)					e_n , INPUT-REFERRED NOISE (μV_{RMS})				
		f_{DATA}					f_{DATA}				
		250	500	1000	2000	4000	250	500	1000	2000	4000
1	Buffer	135	132	129	126	123	0.31	0.44	0.63	0.89	1.25
1	PGA	137	134	131	128	125	0.25	0.35	0.50	0.70	0.99
2	PGA	135	132	129	126	123	0.16	0.22	0.31	0.44	0.63
4	PGA	133	130	127	124	121	0.10	0.14	0.20	0.28	0.39
8	PGA	128	125	122	119	116	0.09	0.12	0.18	0.25	0.35
16	PGA	123	120	117	114	111	0.08	0.11	0.16	0.22	0.31
32	PGA	117	114	111	108	105	0.08	0.11	0.16	0.22	0.31
64	PGA	111	108	105	102	99	0.08	0.11	0.16	0.22	0.31

表 7-3. Low-Power Mode Noise Performance ($V_{REF} = 4.096\text{ V}$, $AVDD1 = 5\text{ V}$, $R_S = 0\ \Omega$)

GAIN	MODE	DYNAMIC RANGE (dB)					e_n , INPUT-REFERRED NOISE (μV_{RMS})				
		f_{DATA}					f_{DATA}				
		125	250	500	1000	2000	125	250	500	1000	2000
1	Buffer	135	132	129	126	123	0.31	0.44	0.63	0.89	1.25
1	PGA	138	135	132	129	126	0.22	0.31	0.44	0.63	0.89
2	PGA	137	134	131	128	125	0.12	0.18	0.25	0.35	0.50
4	PGA	135	132	129	126	123	0.08	0.11	0.16	0.22	0.31
8	PGA	131	128	125	122	119	0.06	0.09	0.12	0.18	0.25
16	PGA	126	123	120	117	114	0.06	0.08	0.11	0.16	0.22
32	PGA	120	117	114	111	108	0.06	0.08	0.11	0.16	0.22
64	PGA	114	111	108	105	102	0.06	0.08	0.11	0.16	0.22

表 7-4. High-Power Mode Noise Performance ($V_{REF} = 2.5\text{ V}$, $AVDD1 = 3.3\text{ V}$, $R_S = 0\ \Omega$)

GAIN	MODE	DYNAMIC RANGE (dB)					e_n , INPUT-REFERRED NOISE (μV_{RMS})				
		f_{DATA}					f_{DATA}				
		250	500	1000	2000	4000	250	500	1000	2000	4000
1	Buffer	135	132	129	126	123	0.31	0.44	0.63	0.89	1.25
1 ⁽¹⁾	PGA	128	125	122	119	116	0.35	0.50	0.70	0.99	1.40
2	PGA	133	130	127	124	121	0.20	0.28	0.39	0.56	0.79
4	PGA	132	129	126	123	120	0.11	0.16	0.22	0.31	0.44
8	PGA	129	126	123	120	117	0.08	0.11	0.16	0.22	0.31
16	PGA	125	122	119	116	113	0.06	0.09	0.12	0.18	0.25
32	PGA	119	116	113	110	107	0.06	0.09	0.12	0.17	0.25
64	PGA	113	110	107	104	101	0.06	0.09	0.12	0.17	0.25

表 7-5. Mid-Power Mode Noise Performance ($V_{REF} = 2.5\text{ V}$, $AVDD1 = 3.3\text{ V}$, $R_S = 0\ \Omega$)

GAIN	MODE	DYNAMIC RANGE (dB)					e_n , INPUT-REFERRED NOISE (μV_{RMS})				
		f_{DATA}					f_{DATA}				
		250	500	1000	2000	4000	250	500	1000	2000	4000
1	Buffer	135	132	129	126	123	0.31	0.44	0.63	0.89	1.25
1 ⁽¹⁾	PGA	128	125	122	119	116	0.35	0.50	0.70	0.99	1.40
2	PGA	133	130	127	124	121	0.20	0.28	0.39	0.56	0.79
4	PGA	131	128	125	122	119	0.12	0.18	0.25	0.35	0.50
8	PGA	127	124	121	118	115	0.10	0.14	0.20	0.28	0.39
16	PGA	123	120	117	114	111	0.08	0.11	0.16	0.22	0.31
32	PGA	117	114	111	108	105	0.08	0.11	0.16	0.22	0.31
64	PGA	111	108	105	102	99	0.08	0.11	0.16	0.22	0.31

表 7-6. Low-Power Mode Noise Performance ($V_{REF} = 2.5\text{ V}$, $AVDD1 = 3.3\text{ V}$, $R_S = 0\ \Omega$)

GAIN	MODE	DYNAMIC RANGE (dB)					e_n , INPUT-REFERRED NOISE (μV_{RMS})				
		f_{DATA}					f_{DATA}				
		125	250	500	1000	2000	125	250	500	1000	2000
1	Buffer	135	132	129	126	123	0.31	0.44	0.63	0.89	1.25
1 ⁽¹⁾	PGA	129	126	123	120	117	0.31	0.44	0.83	0.89	1.25
2	PGA	134	131	128	125	122	0.18	0.25	0.35	0.50	0.70
4	PGA	133	130	127	124	121	0.10	0.14	0.20	0.28	0.39
8	PGA	130	127	124	121	118	0.07	0.10	0.14	0.20	0.28
16	PGA	125	122	119	116	113	0.06	0.09	0.12	0.17	0.25
32	PGA	119	116	113	110	107	0.06	0.09	0.12	0.17	0.25
64	PGA	113	110	107	104	101	0.06	0.09	0.12	0.17	0.25

(1) Because of the limited input headroom with $AVDD1 = 3.3\text{ V}$ operation, the available input range with PGA gain operation = 1 is $\pm 1.35 V_{PP}$. The dynamic range data for PGA gain = 1 and $AVDD1 = 3.3\text{ V}$ reflects the reduced input range.

8 Detailed Description

8.1 Overview

The ADS1285 is a high-resolution, low-power analog-to-digital converter (ADC) designed for applications in energy exploration, geology, and seismic monitoring where low-power consumption and high resolution are required. The converter provides 32 bits of resolution spanning data rates from 125 SPS to 4000 SPS. The programmable gain amplifier (PGA) expands the system dynamic range by accepting signals ranging from $\pm 2.5 V_{PP}$ to $\pm 0.039 V_{PP}$.

As illustrated in the *Functional Block Diagram*, the ADC consists of the following sections: input multiplexer (MUX), programmable gain amplifier (PGA), unity-gain buffer, delta-sigma ($\Delta\Sigma$) modulator, sample rate converter, infinite impulse response (IIR) high-pass filter (HPF), finite impulse response (FIR) low-pass filter (LPF), and an SPI-compatible serial interface used for both device configuration and conversion data readback.

The input multiplexer selects between inputs 1 and 2, and internal options designed for self-test, including an input-short option used to test offset and noise.

The input multiplexer is followed by a low-noise PGA. The PGA gain range is 1 to 16, with gains 32 and 64 provided as digital gains. The PGA is chopper-stabilized to reduce $1/f$ noise and input offset voltage. The PGA output connects to a buffer which drives the modulator. An external 10-nF capacitor, connected to PGA output pins CAPP and CAPN, provides an antialias filter for the input signal.

The PGA can be disabled to lower device power consumption by operating the ADC with the unity-gain buffer. External 47-nF capacitors connected to each buffer output filters the modulator sampling pulses.

The $\Delta\Sigma$ modulator measures the differential input signal (V_{IN}) against the differential reference voltage (V_{REF}). The modulator provides three reference voltage options (2.5 V, 4.096 V, or 5 V). The reference voltage is programmed by the user.

Modulator data are processed by the digital filter providing the final conversion result. The digital filter consists of a sinc filter followed by a programmable phase, FIR low-pass filter, and an IIR high-pass filter. The high-pass filter removes dc and low-frequency components from the data.

The sample rate converter (SRC) compensates clock frequency error by resampling the output data. The clock frequency compensation range is ± 244 ppm with 7-ppb resolution.

User-programmable gain and offset calibration registers correct offset and gain errors.

The SYNC pin synchronizes the ADC. Synchronization has two modes of operation: pulse synchronization and continuous synchronization. The RESET pin resets the ADC, including user configuration settings. The pins are noise-resistant, Schmitt-trigger inputs to increase reliability in high-noise environments.

The $\overline{\text{PWDN}}$ pin powers down the ADC when not in use. The software power-down mode (STANDBY) is available through the serial interface

The 4-wire, SPI-compatible, serial interface reads conversion data and reads or writes device register data.

Two general-purpose digital I/Os are available for system level control.

Power for the PGA and buffer is supplied by AVDD1 and AVSS. A charge pump voltage regulator increases the input voltage range of the buffer that follows the PGA. Power for the modulator is supplied by AVDD2. IOVDD supplies the digital logic core through a 1.8-V low-dropout regulator (LDO). IOVDD is the digital I/O supply.

8.2 Functional Block Diagram

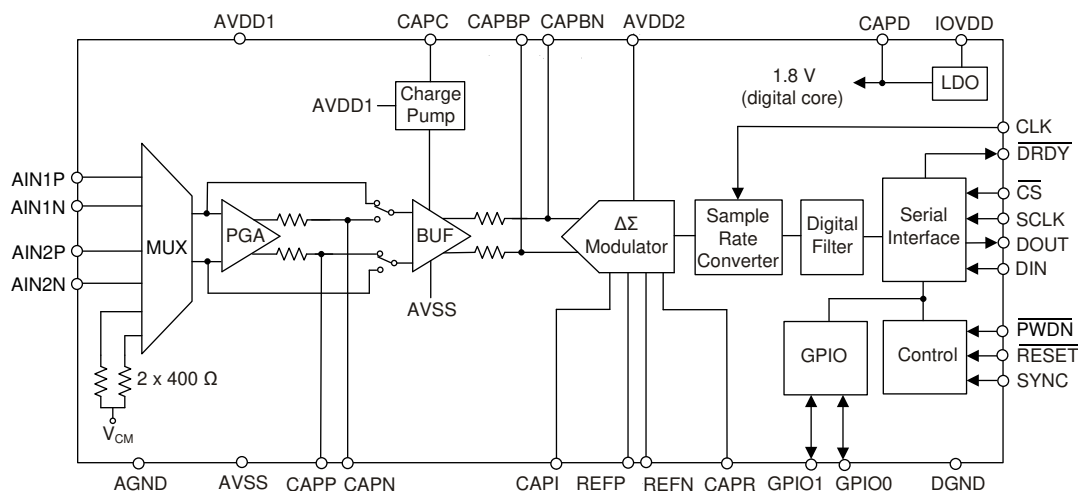

8.3 Feature Description

8.3.1 Analog Input

8-1 shows the analog input circuit and input multiplexer.

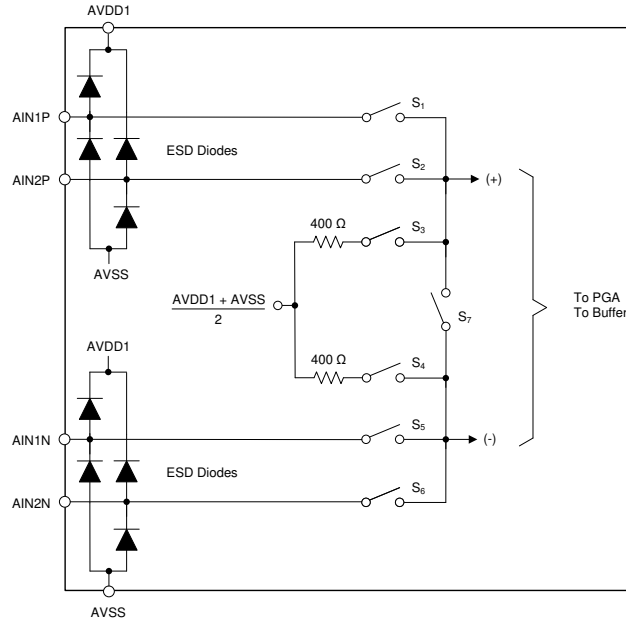

8-1. Analog Input and Multiplexer

Electrostatic discharge (ESD) diodes are incorporated to protect the ADC inputs from ESD events that occur during device manufacturing and printed circuit board (PCB) assembly process when assembled in an ESD-controlled environment. For system-level protection, consider using external ESD protection devices to protect the input that are exposed to ESD events.

If the inputs are driven below $AVSS - 0.3\text{ V}$, or above $AVDD1 + 0.3\text{ V}$, the protection diodes can conduct. If these conditions are possible, use external clamp diodes, series resistors, or both to limit input current to the specified maximum value. Overdriving an unused input channel can affect the conversion results of the active input channel. Clamp the overdriven voltage with Schottky diodes to prevent channel crosstalk.

The ADC incorporates two differential input channels. The multiplexer selects between the two differential inputs for measurement. A test mode to measure noise and offset is also provided by the multiplexer. The shorted input test configuration is available with or without the 400- Ω resistors to simulate the thermal noise generated by an 800- Ω geophone. Table 8-1 summarizes the multiplexer configurations.

表 8-1. Input Multiplexer Modes

MUX[2:0] BITS	SWITCHES	DESCRIPTION
000	S ₁ , S ₅	Input AIN1P, AIN1N connection
001	S ₂ , S ₆	Input AIN2P, AIN2N connection
010	S ₃ , S ₄	400- Ω input-short test mode for offset and noise test.
011	S ₁ , S ₅ , S ₂ , S ₆	Cross-connection test mode. Inputs AIN1P, AIN2P and AIN2P, AIN2N are connected
100	—	Reserved
101	S ₃ , S ₄ , S ₇	0- Ω input-short test mode for offset and noise test.

To test geophone THD performance, apply a test signal to the test channel through series resistors. The series resistors are typically half the value of the geophone impedance. Select the multiplexer for the cross-connection test mode (MUX[2:0] = 011b). In cross-connection mode, the test signal is cross-fed to the geophone input.

Geophone THD test performance can be affected by the nonlinear on-resistance of the multiplexer (R_{SW}). [Figure 8-2](#) shows a model of the input multiplexer resistance for the geophone THD test. [Figure 8-3](#) shows THD performance versus a test resistor (R_{LOAD}) used to simulate geophone resistance. Small amplitude test signals (such as, $V_{IN} = 0.221$ V), shows less THD performance degradation for geophone resistance $< 500 \Omega$.

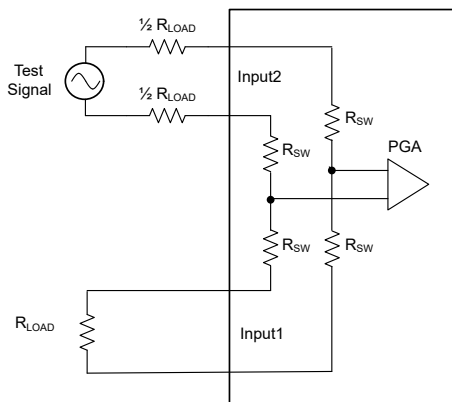

Figure 8-2. THD versus R_{LOAD} Test Circuit

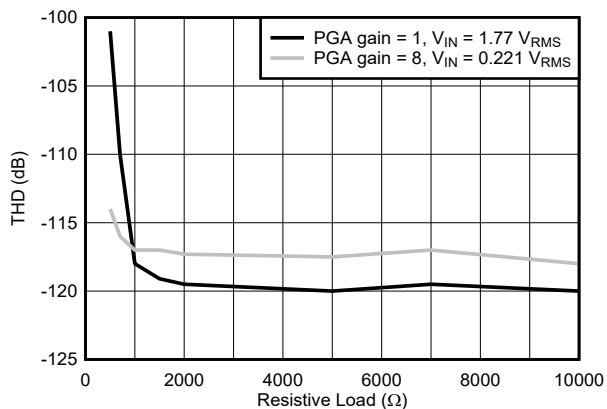

Figure 8-3. THD Performance vs R_{LOAD}

8.3.2 PGA and Buffer

[Figure 8-4](#) shows the simplified PGA and buffer block diagram.

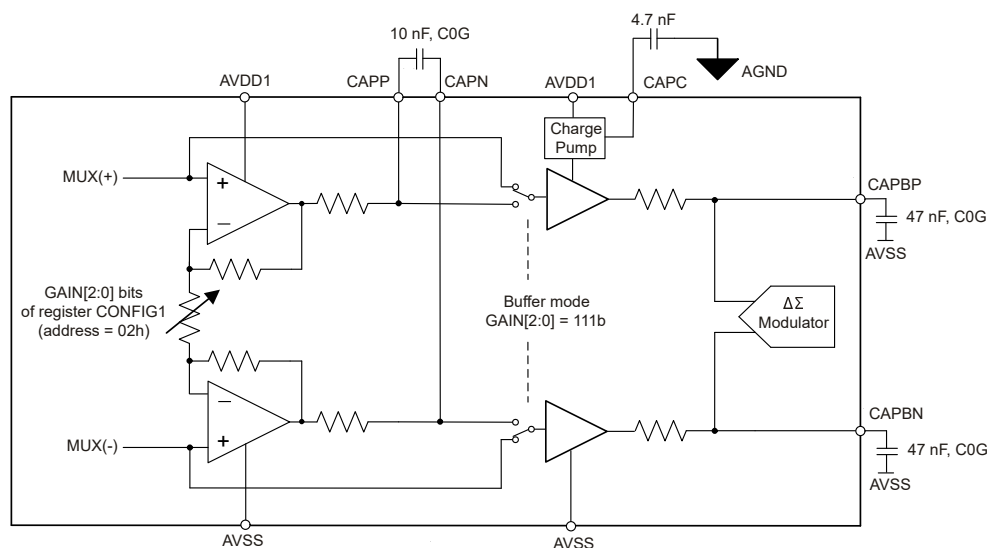

Figure 8-4. PGA and Buffer Block Diagram

The device can be operated with the PGA or the unity-gain buffer. Buffer operation disables the PGA bias, reducing device power consumption. Because of the limited input headroom for PGA gain = 1 when operating with $AVDD1 = 3.3$ V, the buffer must be used under this condition.

8.3.2.1 Programmable Gain Amplifier (PGA)

The PGA is a low-noise, chopper-stabilized differential amplifier that extends the ADC dynamic range performance. The PGA provides analog gains from 1 to 16, with gains of 32 and 64 provided by digital scaling. The PGA output signal is routed to the CAPP and CAPN pins through 270- Ω resistors. Connect an external 10-nF, C0G-dielectric capacitor across these pins. An antialias filter is formed by these components to attenuate the signal level at the modulator aliasing frequency (f_{MOD}).

As shown in 8-4, the buffer is used between the PGA and the modulator. Connect two 47-nF, C0G-dielectric capacitors from each buffer output to AVSS (CAPBP and CAPBN). A voltage charge pump increases the buffer input voltage headroom. Connect an external 4.7-nF capacitor between CAPC and AGND for charge pump operation.

The PGA gain is programmed by the GAIN[2:0] bits of the CONFIG1 register. 表 8-2 shows the PGA gain settings and buffer selection. The PGA gains and input signal range are irrespective of the voltage reference.

表 8-2. PGA Gains

GAIN[2:0] REGISTER BITS	PGA GAIN	INPUT SIGNAL RANGE (V _{PP})
000	1	±2.5
001	2	±1.25
010	4	±0.625
011	8	±0.3125
100	16	±0.15625
101	32	±0.078125
110	64	±0.0390625
111	Buffer mode, gain = 1	±2.5

Observe the PGA input and output voltage headroom specification. 8-5 shows the input and output voltage headroom when operating with AVDD1 = 5 V, an input common-mode voltage (V_{CM}) = 2.5 V, a differential input voltage = ±2.5 V_{PP}, and at gain = 1. The absolute minimum and maximum PGA input voltage (1.25 V and 3.75 V) is ±1/2 of the differential signal voltage plus the common-mode voltage. The PGA provides 0.15-V input voltage margin at the negative peak and 0.4-V input voltage margin at the positive peak. As shown in the figure, the PGA gain increases by × 1.5 when the ADC is operated with 4.096-V or 5-V voltage references. The PGA provides 0.475-V output voltage margin at the positive and negative peaks.

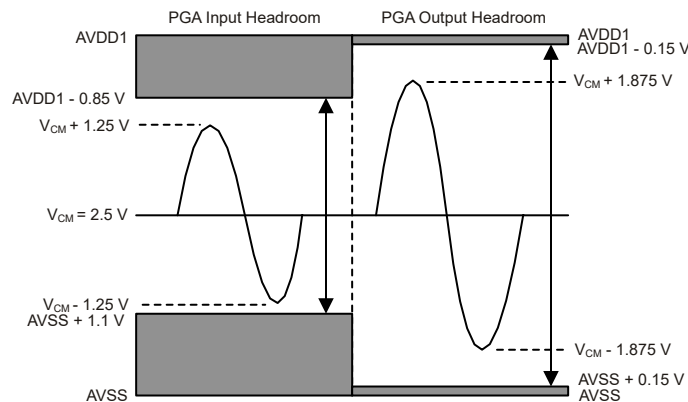

8-5. PGA Headroom (AVDD1 = 5 V, PGA Gain = 1)

When operating with AVDD1 = 3.3 V, the PGA cannot support ±2.5-V_{PP} input signals. Use the buffer for ±2.5-V_{PP} input signals. For ±1.25-V_{PP} input signals (PGA gain = 2), the input headroom is increased by increasing the common-mode voltage by 0.1 V to AVSS + 1.75 V. 8-6 illustrates the input and output operating headroom for AVDD1 = 3.3 V, V_{CM} = 1.75 V, input signal = ±1.25 V_{PP}, and gain = 2. The PGA uses normal gain scaling when V_{REF} = 2.5 V.

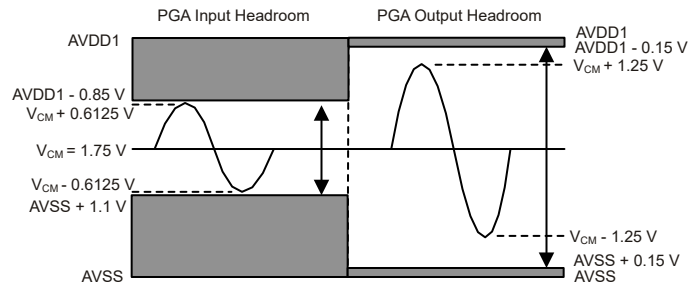

8-6. PGA Headroom (AVDD1 = 3.3 V, Gain = 2)

8.3.2.2 Buffer Operation (PGA Bypass)

The ADC provides a buffer option, bypassing the PGA. Bypassing the PGA reduces device power consumption. Use the buffer for $\pm 2.5\text{-V}_{PP}$ input signals when operating AVDD1 at 3.3 V. Buffer operation is enabled by setting the GAIN[2:0] bits = 111b of the [CONFIG1 register](#).

8-7 shows the buffer voltage headroom with AVDD1 = 3.3 V, $V_{CM} = 1.65\text{ V}$, and the input signal = $\pm 2.5\text{ V}_{PP}$. The buffer has sufficient voltage headroom for $\pm 2.5\text{-V}_{PP}$ input signals when operating with AVDD1 = 3.3 V.

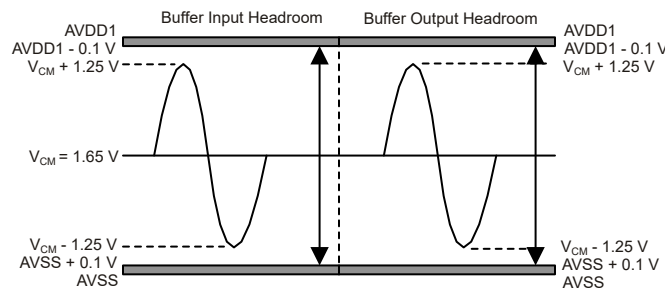

8-7. Buffer Headroom (3.3-V Operation Shown)

Regardless of PGA or buffer operation, connect two 47-nF, C0G-dielectric capacitors from each buffer output to AVSS (CAPBP and CAPBN). The voltage charge pump increases the buffer input operating headroom. Connect an external 4.7-nF capacitor between CAPC and AGND for the charge pump operation.

8.3.3 Voltage Reference Input

The ADC requires a reference voltage for operation. The reference voltage input is differential, defined as the voltage between the REFP and REFN pins: $V_{REF} = V_{REFP} - V_{REFN}$. Because of the differential input, the VREFN trace can be routed to the voltage reference ground terminal to avoid ground noise pickup.

The device offers the choice of three reference voltages: 5 V, 4.096 V, or 2.5 V. Maximum dynamic range performance is achieved using $V_{REF} = 5\text{ V}$ or 4.096 V, which requires AVDD1 = 5 V for operation. If AVDD1 = 3.3 V, the reference voltage is limited to 2.5 V. Program the reference voltage to match the physical voltage by the REF[1:0] bits of the [CONFIG1 register](#). Use a precision voltage reference with low noise, optimally less than 0.5 μV_{RMS} over the measurement bandwidth.

8-8 illustrates a simplified reference input circuit. Similar to the analog inputs, the reference inputs are protected by ESD diodes. If the reference inputs are driven below AVSS - 0.3 V or above AVDD1 + 0.3 V, the protection diodes can conduct. If these conditions are possible, use external clamp diodes, series resistors, or both to limit the reference input current to the specified value.

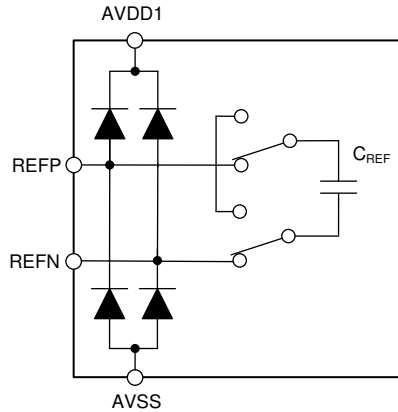

8-8. Simplified Voltage Reference Input Circuit

The ADC samples the reference voltage by an internal capacitor (C_{REF}) and then discharges the capacitor at the modulator sampling frequency (f_{MOD}). The sampling operation results in transient current flow into the reference inputs. The transient current is filtered by a 0.1- μ F ceramic capacitor placed directly at the reference pins with a larger 10- μ F to 47- μ F capacitor at the voltage reference output. In applications where the voltage reference drives multiple ADCs, use 0.1- μ F capacitors at each ADC.

The external capacitor filters the current transients, resulting in an average reference current. The average reference current is 110 μ A/V for high- and mid-power operating modes and 80 μ A/V for low-power operating mode. For example, with $V_{REF} = 4.096$ V, the reference input current is $110 \mu\text{A} / \text{V} \times 4.096 \text{ V} = 451 \mu\text{A}$.

8.3.4 IOVDD Power Supply

The IOVDD digital supply operates in two voltage ranges: 1.65 V to 1.95 V and 2.7 V to 3.6 V. If operating IOVDD in the 1.65-V to 1.95-V range, connect IOVDD directly to the CAPD pin. 8-9 shows the required connection if IOVDD is operating in the 1.65-V to 1.95-V range. Otherwise, if operating IOVDD in the 2.7-V to 3.6-V range, do not connect these pins together.

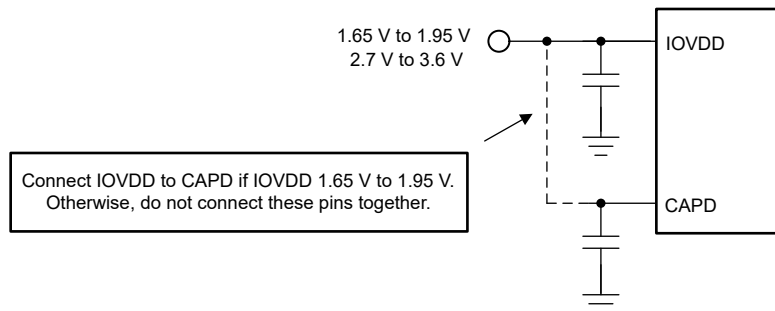

8-9. IOVDD Power-Supply Connection

8.3.5 Modulator

The modulator is a multibit delta-sigma architecture featuring low power and outstanding dynamic range performance with very low levels of spurious tones in the frequency spectrum. The modulator shapes the quantization noise of the internal quantizer to an out-of-band frequency range where the noise is removed by the digital filter. Noise remaining within the pass-band region is thermal noise with constant density (white noise). The integrated noise within the pass band is determined by the digital filter OSR.

8.3.5.1 Modulator Overdrive

The modulator is an inherently stable design and, therefore exhibits predictable recovery from input overdrive. If the modulator is overdriven at the peaks of the input signal, the filter output data may or may not clip depending on the duration of the signal overdrive resulting from the data averaging of the digital filter. If the modulator is

heavily overdriven, then the likelihood of clipped conversion data increases. Be aware the group delay of the digital filter delays the occurrence of an input overdrive event from appearing in the output data.

8.3.6 Digital Filter

The digital filter decimates and filters the modulator data to provide the high-resolution output data. By adjusting the amount of filtering through the OSR, trade-offs can be made between total noise and bandwidth. Increasing the OSR lowers total noise while decreasing the signal bandwidth.

As shown in [Figure 8-10](#), the sample rate converter (SRC) receives data from the modulator prior to input to the digital filter block. See the [Sample Rate Converter](#) section for details.

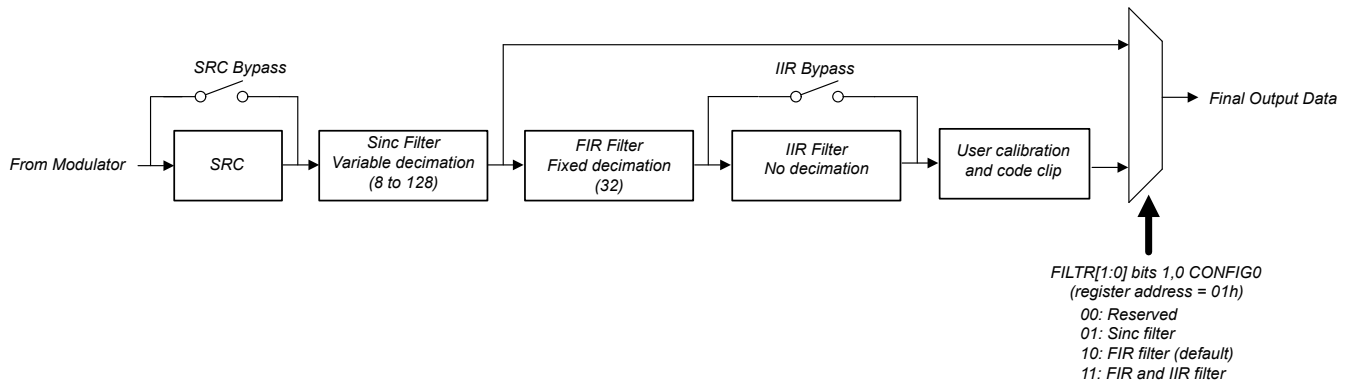

Figure 8-10. Digital Filter Block Diagram

The digital filter is comprised of three sections: a variable-decimation sinc filter; a variable-coefficient, fixed-decimation FIR filter; and a programmable high-pass filter (IIR). The desired filter path is selected by the FILTER[1:0] bits of the [CONFIG0 register](#). The sinc filter provides partially filtered data, bypassing the FIR and HPF filters and user calibration. For fully filtered data, select the FIR filter option. The IIR filter stage removes dc and low-frequency data. The FIR and the combined FIR + IIR filter are routed to the user calibration block and output code clipping block. See the [Offset and Gain Calibration](#) section for details of user calibration.

8.3.6.1 Sinc Filter Section

The first section of the digital filter is a variable-decimation, fifth-order sinc filter (sinc/x). Modulator data are passed through the sample rate converter to the sinc filter at the nominal rate of $f_{\text{MOD}} = f_{\text{CLK}} / 4 = 2.048 \text{ MHz}$ (1.024-MHz low-power mode). The sinc filter partially filters the data for the FIR filter that produces the final frequency response. The sinc filter data are intended to be used with post-processing filters to shape the final frequency response.

[Table 8-3](#) shows the decimation ratio and the resulting output data rate of the sinc filter. The sinc filter data rate is programmed by the DR[2:0] bits of the [CONFIG0 register](#).

Table 8-3. Sinc Filter Data Rates

DR[2:0] BITS	SINC DECIMATION RATIO (N)	DATA RATE (SPS)	
		HIGH- AND MID-POWER MODES	LOW-POWER MODE
000	256	8,000	4,000
001	128	16,000	8,000
010	64	32,000	16,000
011	32	64,000	32,000
100	16	128,000	64,000

[Equation 2](#) shows the Z-domain transfer function of the sinc filter.

$$H(Z) = \left[\frac{1 - Z^{-N}}{N(1 - Z^{-1})} \right]^5 \quad (2)$$

where:

- N = Decimation ratio of 表 8-3

式 3 shows the frequency domain transfer function of the sinc filter.

$$|H(f)| = \left| \frac{\sin \left[\frac{\pi N \times f}{f_{\text{MOD}}} \right]}{N \sin \left[\frac{\pi \times f}{f_{\text{MOD}}} \right]} \right|^5 \quad (3)$$

where:

- N = Decimation ratio shown in 表 8-3
- f = Input signal frequency
- f_{MOD} = Modulator sampling frequency = $f_{\text{CLK}} / 4$ (sample rate converter disabled)

The sinc filter frequency response has notches (or zeros) occurring at the output data rate and multiples thereof. At these frequencies, the filter has zero gain. 图 8-11 shows the wide-band frequency response of the sinc filter and 图 8-12 shows details of the -3-dB response.



图 8-11. Sinc Filter Frequency Response



图 8-12. Sinc Filter -3-dB Response

图 8-13 illustrates the sinc filter frequency response at $f_{\text{DATA}} = 32$ kSPS. The tones at 1 kHz and harmonics are the result of dither added to the modulator input to suppress idle tones. The frequency of the dither signal is f_{MOD} divided by the combined decimation ratio shown in 表 8-4. The rise of the noise floor at 2 kHz is resultant of modulator noise shaping. For sinc filter decimation $N = 64$ (data rate = 32 kSPS), the usable bandwidth by the use of external post filtering is 500 Hz.

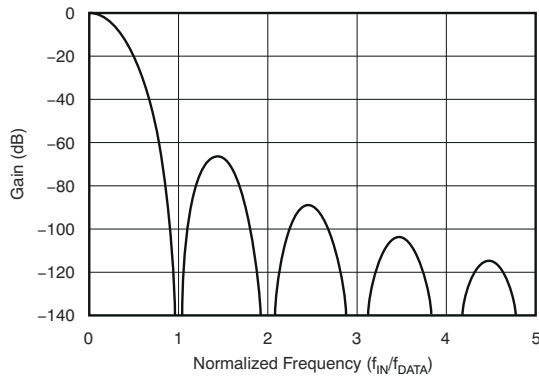

图 8-13. FFT Output of the Sinc Filter ($f_{DATA} = 32$ kSPS)

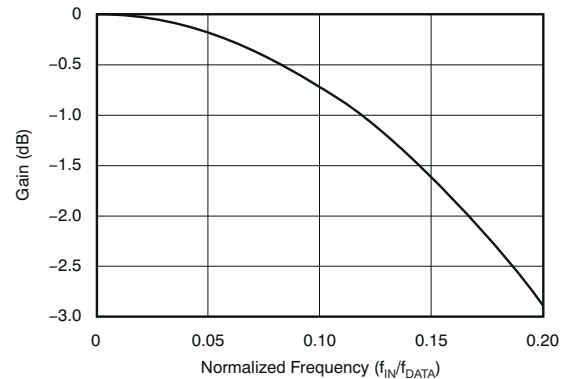
The sinc filter data bypasses the data scaling, clip stage, and user calibration, and as a result, the sinc filter data are scaled differently compared to the FIR filter. See the [Conversion Data Format](#) section for details of sinc filter data scaling.

8.3.6.2 FIR Filter Section

The second section of the digital filter is a multistage, FIR low-pass filter. Partially filtered data from the sinc filter are input to the FIR filter. The FIR filter determines the final frequency and phase response of the data. [图 8-14](#) shows that the FIR filter consists of four stages.

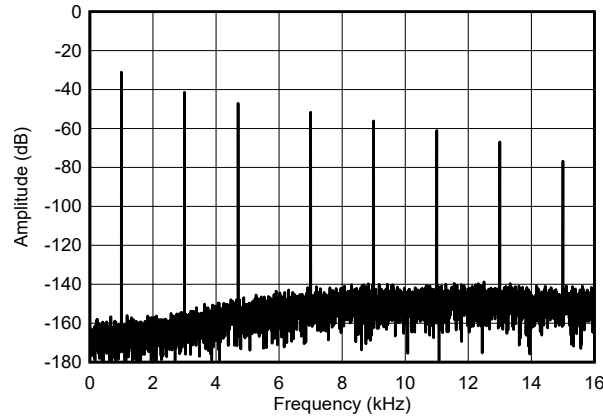

图 8-14. FIR Filter

The first two FIR stages are half-band filters with decimation = 2 for each stage. The third and fourth FIR stages determine the final frequency and phase response. Decimation is 4 and 2, for FIR stages three and four. The overall decimation ratio of the FIR filter is 32. Unique coefficient sets in stage 3 and 4 determine linear and minimum phase filter response. The phase response is selected by the PHASE bit of the [CONFIG0 register](#). [表 8-4](#) lists the combined decimation ratio of the sinc and FIR filter stages and the corresponding FIR filter data rate.

表 8-4. FIR Filter Data Rate

DR[2:0] BITS	COMBINED DECIMATION RATIO	DATA RATE (SPS)	
		HIGH- AND MID-POWER MODES	LOW-POWER MODE
000	8192	250	125
001	4096	500	250
010	2048	1000	500
011	1024	2000	1000
100	512	4000	2000

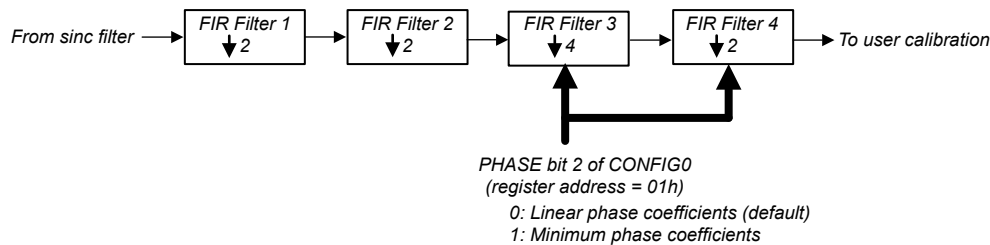
[表 8-5](#) lists the FIR filter coefficients and the data scaling for the linear and minimum phase coefficients.

表 8-5. FIR Filter Coefficients

COEFFICIENT	STAGE 1	STAGE 2	STAGE 3		STAGE 4	
	SCALE = 1/512	SCALE = 1/8388608	SCALE = 1/134217728		SCALE = 1/134217728	
	LINEAR PHASE	LINEAR PHASE	LINEAR PHASE	MINIMUM PHASE	LINEAR PHASE	MINIMUM PHASE
b ₀	3	-10944	0	819	-132	11767
b ₁	0	0	0	8211	-432	133882
b ₂	-25	103807	-73	44880	-75	769961
b ₃	0	0	-874	174712	2481	2940447
b ₄	150	-507903	-4648	536821	6692	8262605
b ₅	256	0	-16147	1372637	7419	17902757
b ₆	150	2512192	-41280	3012996	-266	30428735
b ₇	0	4194304	-80934	5788605	-10663	40215494
b ₈	-25	2512192	-120064	9852286	-8280	39260213
b ₉	0	0	-118690	14957445	10620	23325925
b ₁₀	3	-507903	-18203	20301435	22008	-1757787
b ₁₁		0	224751	24569234	348	-21028126
b ₁₂		103807	580196	26260385	-34123	-21293602
b ₁₃		0	893263	24247577	-25549	-3886901
b ₁₄		-10944	891396	18356231	33460	14396783
b ₁₅			293598	9668991	61387	16314388
b ₁₆			-987253	327749	-7546	1518875
b ₁₇			-2635779	-7171917	-94192	-12979500
b ₁₈			-3860322	-10926627	-50629	-11506007
b ₁₉			-3572512	-10379094	101135	2769794
b ₂₀			-822573	-6505618	134826	12195551
b ₂₁			4669054	-1333678	-56626	6103823
b ₂₂			12153698	2972773	-220104	-6709466
b ₂₃			19911100	5006366	-56082	-9882714
b ₂₄			25779390	4566808	263758	-353347
b ₂₅			27966862	2505652	231231	8629331
b ₂₆			25779390	126331	-215231	5597927
b ₂₇			19911100	-1496514	-430178	-4389168
b ₂₈			12153698	-1933830	34715	-7594158
b ₂₉			4669054	-1410695	580424	-428064
b ₃₀			-822573	-502731	283878	6566217
b ₃₁			-3572512	245330	-588382	4024593
b ₃₂			-3860322	565174	-693209	-3679749
b ₃₃			-2635779	492084	366118	-5572954
b ₃₄			-987253	231656	1084786	332589
b ₃₅			293598	-9196	132893	5136333
b ₃₆			891396	-125456	-1300087	2351253
b ₃₇			893263	-122207	-878642	-3357202
b ₃₈			580196	-61813	1162189	-3767666
b ₃₉			224751	-4445	1741565	1087392
b ₄₀			-18203	22484	-522533	3847821
b ₄₁			-118690	22245	-2490395	919792
b ₄₂			-120064	10775	-688945	-2918303
b ₄₃			-80934	940	2811738	-2193542
b ₄₄			-41280	-2953	2425494	1493873
b ₄₅			-16147	-2599	-2338095	2595051
b ₄₆			-4648	-1052	-4511116	-79991
b ₄₇			-874	-43	641555	-2260106
b ₄₈			-73	214	6661730	-963855
b ₄₉			0	132	2950811	1482337
b ₅₀			0	33	-8538057	1480417
b ₅₁			0	0	-10537298	-586408
b ₅₂					9818477	-1497356

表 8-5. FIR Filter Coefficients (continued)

COEFFICIENT	STAGE 1	STAGE 2	STAGE 3		STAGE 4	
	SCALE = 1/512	SCALE = 1/8388608	SCALE = 1/134217728		SCALE = 1/134217728	
	LINEAR PHASE	LINEAR PHASE	LINEAR PHASE	MINIMUM PHASE	LINEAR PHASE	MINIMUM PHASE
b ₅₃					41426374	-168417
b ₅₄					56835776	1166800
b ₅₅					41426374	644405
b ₅₆					9818477	-675082
b ₅₇					-10537298	-806095
b ₅₈					-8538057	211391
b ₅₉					2950811	740896
b ₆₀					6661730	141976
b ₆₁					641555	-527673
b ₆₂					-4511116	-327618
b ₆₃					-2338095	278227
b ₆₄					2425494	363809
b ₆₅					2811738	-70646
b ₆₆					-688945	-304819
b ₆₇					-2490395	-63159
b ₆₈					-522533	205798
b ₆₉					1741565	124363
b ₇₀					1162189	-107173
b ₇₁					-878642	-131357
b ₇₂					-1300087	31104
b ₇₃					132893	107182
b ₇₄					1084786	15644
b ₇₅					366118	-71728
b ₇₆					-693209	-36319
b ₇₇					-588382	38331
b ₇₈					283878	38783
b ₇₉					580424	-13557
b ₈₀					34715	-31453
b ₈₁					-430178	-1230
b ₈₂					-215231	20983
b ₈₃					231231	7729
b ₈₄					263758	-11463
b ₈₅					-56082	-8791
b ₈₆					-220104	4659
b ₈₇					-56626	7126
b ₈₈					134826	-732
b ₈₉					101135	-4687
b ₉₀					-50629	-976
b ₉₁					-94192	2551
b ₉₂					-7546	1339
b ₉₃					61387	-1103
b ₉₄					33460	-1085
b ₉₅					-25549	314
b ₉₆					-34123	681
b ₉₇					348	16
b ₉₈					22008	-349
b ₉₉					10620	-96
b ₁₀₀					-8280	144
b ₁₀₁					-10663	78
b ₁₀₂					-266	-46
b ₁₀₃					7419	-42
b ₁₀₄					6692	9
b ₁₀₅					2481	16

表 8-5. FIR Filter Coefficients (continued)

COEFFICIENT	STAGE 1	STAGE 2	STAGE 3		STAGE 4	
	SCALE = 1/512	SCALE = 1/8388608	SCALE = 1/134217728		SCALE = 1/134217728	
	LINEAR PHASE	LINEAR PHASE	LINEAR PHASE	MINIMUM PHASE	LINEAR PHASE	MINIMUM PHASE
b ₁₀₆					-75	0
b ₁₀₇					-432	-4
b ₁₀₈					-132	0
b ₁₀₉					0	0

Figure 8-15 shows the FIR pass-band frequency response to $0.375 \times f_{\text{DATA}}$ with ± 0.003 -dB pass-band ripple. Figure 8-16 shows the pass-band, transition-band, and stop-band performance from 0 Hz to f_{DATA} . The filter is designed for -135-dB stop-band attenuation at the Nyquist frequency.

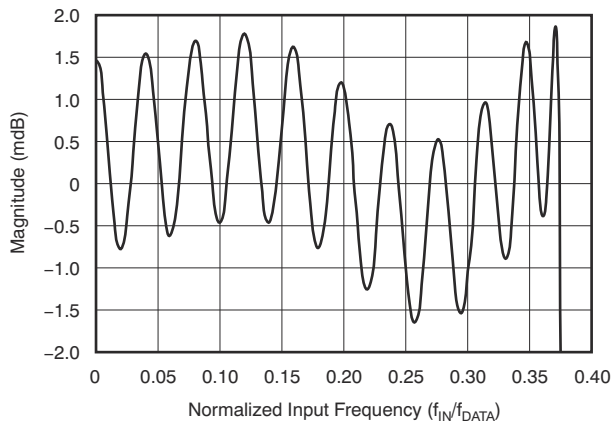

Figure 8-15. FIR Filter Pass-Band Response

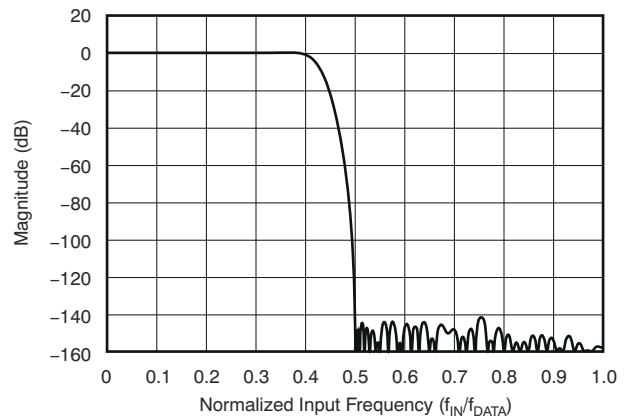

Figure 8-16. FIR Filter Transition Band Response

As with many sampled systems, the filter response repeats at multiples of the modulator sample rate (f_{MOD}). The filter response repeats at frequencies = $N \times f_{\text{MOD}} \pm f_0$, where $N = 1, 2$, and so on, and $f_0 =$ filter pass-band). These frequencies, if not filtered and are otherwise present in the signal, fold back (or alias) into the pass-band causing errors. A low-pass input filter reduces the aliasing error. For a band-limited signal typical of many geophones, a single-pole filter at the PGA output is sufficient to suppress the aliasing frequencies.

8.3.6.3 Group Delay and Step Response

The FIR filter offers linear and minimum phase filter options. The pass-band, transition band, and stop-band responses of the linear and minimum phase filters are the same but differ in phase and step response behavior.

8.3.6.3.1 Linear Phase Response

A linear phase filter has the unique property that the delay from input to output is constant across all input frequencies (that is, constant group delay). The constant delay property is independent of the nature of the input signal (impulse or swept-tone), and therefore the phase is linear across frequency, which can be important when analyzing multitone signals. However, as depicted in Figure 8-17, the group delay is longer for the linear phase filter compared to minimum phase. For both the linear and minimum filters, fully settled data are available 62 conversions after a step input change occurs.

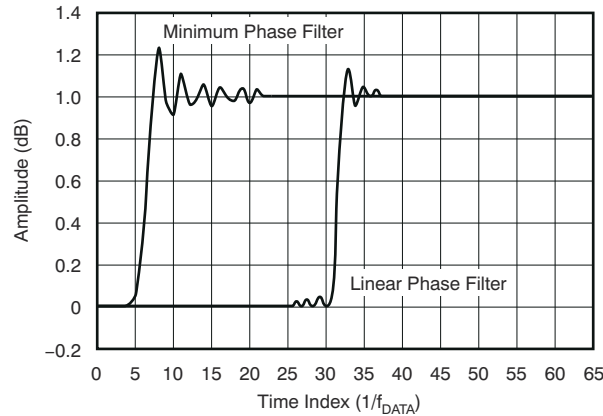

8-17. FIR Step Response

8.3.6.3.2 Minimum Phase Response

The minimum phase filter provides a short group delay for data from filter input to filter output. [8-18](#) shows the group delay for minimum and linear phase filters. The group delay of the minimum phase filter is a function of signal frequency. The PHASE bit of the [CONFIG0 register](#) programs the filter phase.

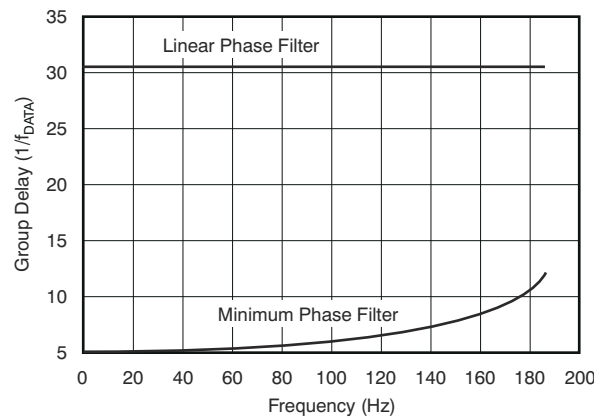

8-18. FIR Group Delay (f_{DATA} = 500 SPS)

8.3.6.4 HPF Stage

The last stage of the digital filter is the high-pass filter (HPF). The high-pass filter is implemented as a first-order, IIR filter. The high-pass filter removes dc and low frequencies from the data. The HPF is enabled by programming the FILTR[1:0] bits = 11b of the [CONFIG0 register](#).

[式 4](#) shows the z-domain transfer function of the filter:

$$H(z) = \frac{2 - a}{2} \frac{1 - z^{-1}}{1 - (1 - a)z^{-1}} \tag{4}$$

where:

- $a = \frac{2\sin(\omega_N)}{\cos(\omega_N) + \sin(\omega_N)}$
- $\omega_N = \pi \times f_C / f_{DATA}$ (normalized corner frequency, radians)
- f_C = Corner frequency (Hz)
- f_{DATA} = Output data rate (Hz)

Be aware the corner frequency programming is a function of f_{DATA} . As shown by 式 5, the value written to the HPF1, HPF0 registers is value a , computed by 式 4, $\times 2^{16}$.

$$HPF[15:0] = a \times 2^{16} \quad (5)$$

表 8-6 shows examples of the high-pass filter programming.

表 8-6. High-Pass Filter Value Examples

HPF[15:0]	f_c (Hz)	f_{DATA} (SPS)
0332h	0.5	250
0332h	1.0	500
019Ah	1.0	1000

The HPF accumulates data to perform the high-pass function. Similar to the operation of an analog HPF after a dc step change is applied to the input, the filter takes time to accumulate data to remove dc from the signal. The lower the corner frequency, the longer the filter takes to settle.

To shorten the HPF settling time, the offset register is used as a *seed* value for the HPF accumulator. The accumulator is loaded with the offset register each time the HPF state is changed from *disabled* to *enabled*. The offset register can be preset with an estimated value, or a calibrated value if the dc level is known. To improve accuracy, scale the offset value by the inverse value of GAIN[3:0] / 400000h. The normal offset operation is disabled when the HPF is enabled.

To initialize the HPF accumulator with the OFFSET[2:0] registers:

1. Disable the HPF.
2. Write the desired value to the OFFSET[2:0] registers.
3. Enable the HPF. OFFSET[2:0] is loaded to the HPF data accumulator.
4. The HPF tracks the remaining dc value from the signal.

Subsequent writes to the OFFSET[2:0] registers are ignored. To reload the contents of the OFFSET[2:0] registers to the HPF, disable and re-enable the HPF.

8.3.7 Clock Input

A clock signal is required for operation. The clock signal is applied to the CLK pin at $f_{CLK} = 8.192$ MHz for high- and mid-power modes and 4.096 MHz for low-power mode. As with many precision data converters, a low-jitter clock is required to achieve data sheet performance. Avoid the use of R-C clock oscillators. A crystal-based clock source is recommended. Avoid ringing on the clock signal by placing a series resistor in the clock PCB trace to source-terminate. Keep the clock signal routed away from other clock signals, input pins, and analog components.

8.3.8 GPIO

The ADC provides two general-purpose I/O (GPIO) pins that can be used as digital inputs or outputs. The GPIO voltage levels are IOVDD and DGND. 图 8-19 illustrates the GPIO block diagram.

The GPIOs are programmed by the GPIO register. The GPIOs are programmed as an input or output by the GPIOx_DIR bits. The GPIO state is read or written by the GPIOx_DAT bits. When programmed as an output, reading the GPIOx_DAT bits returns the register bit value previously written. If the GPIOs are unused, terminate the GPIOs with pulldown resistors to prevent the pins from floating.

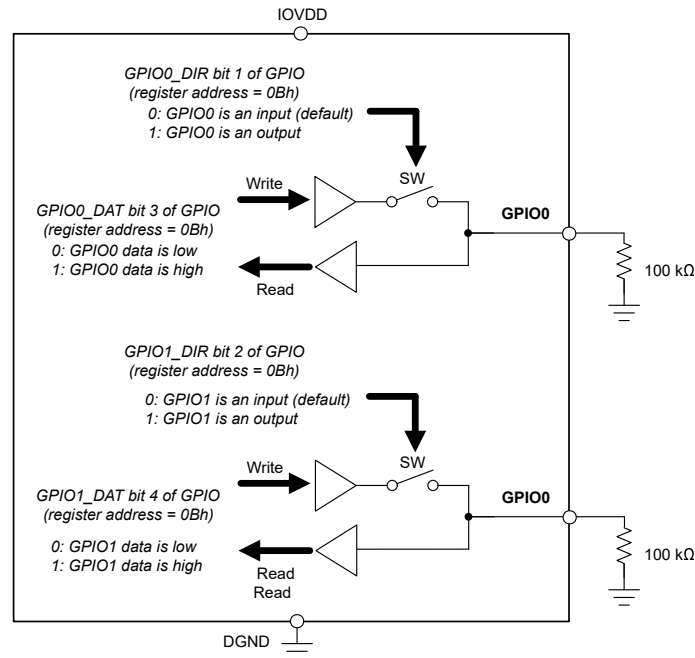

✎ 8-19. GPIO Operation

8.4 Device Functional Modes

8.4.1 Power Modes

There are three power-resolution modes offering trade-offs between power consumption and dynamic range. The modes are high power, mid power, and low power. See the [Noise Performance](#) section for details of noise performance. The MODE[1:0] bits of the [CONFIG0 register](#) selects the power mode. The clock frequency for low-power mode is 4.096 MHz (half-speed clock); therefore, the output data rates are also scaled by one half.

8.4.2 Power-Down Mode

Power-down is engaged by taking the $\overline{\text{PWDN}}$ pin low, or by software control, by sending the STANDBY command. To exit power-down, take $\overline{\text{PWDN}}$ high or send the WAKEUP command to exit software power-down (with the clock running). Power-down disables the analog circuit; however, the digital LDO (CAPD pin) remains biased, drawing a small bias current from IOVDD. In comparison, software power-down draws larger IOVDD bias current. In both power-down modes, the ac signals of the digital outputs are stopped but remain driven high or low. The digital inputs must not be allowed to float; otherwise, leakage current can flow from the IOVDD supply. Reset the ADC if the clock is interrupted in power-down. Synchronization is lost in power-down; therefore, resynchronize the ADC.

8.4.3 Reset

The ADC is reset by three methods: power-on reset (POR), the $\overline{\text{RESET}}$ pin, or the RESET command. Power-on reset occurs when the power-supply voltages cross the respective thresholds. See [Power-Up Switching Characteristics](#) for details. To reset the ADC by pin, drive $\overline{\text{RESET}}$ low for at least two f_{CLK} cycles and return high for reset. By command, reset takes effect on the next rising f_{CLK} edge after the eighth rising edge of SCLK of the reset command. At reset, the filter is restarted and the user registers reset to default. Reset timing is illustrated in [✎ 6-5](#).

8.4.4 Synchronization

The ADC is synchronized by the SYNC pin or by the SYNC command, resulting in restart of the digital filter cycle. Synchronization by the pin occurs on the next rising edge of CLK after SYNC is taken high on the falling edge of CLK. Synchronization by the SYNC command occurs on the rising edge of CLK following the eighth bit of the command.

The following results in loss of synchronization:

- Power-up cycle, ADC reset, or when hardware or software power down modes are entered
- The following mode changes:
 - DR[2:0] (data rate)
 - PHASE (filter phase)
 - MODE[1:0] (power mode)
 - SYNC (synchronization mode)
 - SRC[1:0] (sample rate converter enabled or disabled)

There are two synchronization control modes: pulse sync and continuous sync. The synchronization mode is programmed by the SYNC bit of the ID/SYNC register.

8.4.4.1 Pulse-Sync Mode

The pulse-sync mode unconditionally synchronizes the ADC on the rising edge of SYNC. When synchronized, the internal filter memory is reset, $\overline{\text{DRDY}}$ goes high, and the filter cycle restarts. The following 63 $\overline{\text{DRDY}}$ periods are disabled to allow for digital filter settling. $\overline{\text{DRDY}}$ asserts low when the conversion data are ready. See [Figure 6-4](#) for synchronization timing details.

8.4.4.2 Continuous-Sync Mode

The continuous-sync mode offers the option of accepting a continuous clock signal to the SYNC pin. The ADC compares the period of the SYNC clock signal to N periods of the $\overline{\text{DRDY}}$ signal to qualify resynchronization. Initially, the first SYNC positive edge synchronizes the ADC. Resynchronization occurs only when the time period between rising edges of SYNC over N multiple $\overline{\text{DRDY}}$ periods differ by at least \pm one f_{CLK} cycle, where $N = 1, 2, 3$ and so on. Otherwise, the SYNC clock period is in synchronization with the existing $\overline{\text{DRDY}}$ pulses, so no resynchronization occurs. Be aware the continuous sync mode cannot be used when the sample rate converter is enabled.

After synchronization, $\overline{\text{DRDY}}$ continues to pulse; however, data are held low for 63 data periods to allow for the digital filter to settle. See [Figure 6-4](#) for the $\overline{\text{DRDY}}$ behavior. Because of the initial delay of the digital filter, the SYNC input signal and the $\overline{\text{DRDY}}$ pulses exhibit an offset time. The offset time is a function of the data rate.

8.4.5 Sample Rate Converter

The sample rate converter (SRC) compensates clock frequency error by resampling the modulator data at a new rate set by the compensation factor written to the SRC registers. The frequency compensation range is ± 244 ppm with 7.45-ppb ($1 / 2^{27}$) resolution.

Clock frequency error is compensated by writing a value to the [SCR0](#) and [SRC1](#) registers. The register value is in 2's-complement format for positive and negative frequency error compensation. Positive register data values decrease the data rate frequency (increases the period). The new data rate frequency is observed by the frequency of the $\overline{\text{DRDY}}$ signal.

[Table 8-7](#) shows example values of frequency compensation. 8000h disables the sample rate converter. 0000h passes the data through with no compensation but adds an $8 / f_{\text{CLK}}$ delay to the time delay of SYNC input to the $\overline{\text{DRDY}}$ pulses.

表 8-7. Example SRC Values

SRC[15:0] VALUE	COMPENSATION FACTOR
7FFFh	$(1 - 32,767 / 2^{27}) \times f_{\text{DATA}}$
0001h	$(1 - 1 / 2^{27}) \times f_{\text{DATA}}$
0000h	$1 \times f_{\text{DATA}}$
7FFFh	$(1 + 1 / 2^{27}) \times f_{\text{DATA}}$
8001h	$(1 + 32,767 / 2^{27}) \times f_{\text{DATA}}$
8000h	$1 \times f_{\text{DATA}}$ (SRC disabled)

Resynchronize the ADC after the sample rate converter is enabled or disabled.

Because the SRC is a digital function, operation is deterministic without error. The SRC trim value can be written all at the same time, or written incrementally up to a target value to minimize the step change of frequency. Use the multibyte command operation to write to the SRC registers and complete the write operation 256 CLK cycles before the DRDY falling edge. This procedure loads the high and low bytes simultaneously before they are internally processed. See [Figure 6-7](#) for details.

8.4.6 Offset and Gain Calibration

The ADC integrates calibration registers to correct offset and gain errors. As shown in [Equation 6](#) and [Figure 8-20](#), the 24-bit offset value (OFFSET[23:0]) is subtracted from the filter data before multiplication by the 24-bit gain value (GAIN[23:0]), divided by 400000h. The data are clipped to 32 bits to yield the final output. The offset operation is bypassed when the high-pass filter is enabled.

$$\text{Output} = (\text{Input} - \text{OFFSET}[23:0]) \cdot \frac{\text{GAIN}[23:0]}{400000\text{h}} \tag{6}$$

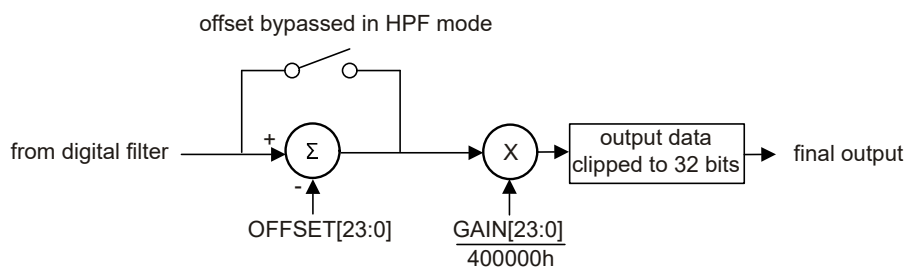

Figure 8-20. Calibration Block Diagram

8.4.6.1 OFFSET Register

Offset correction is by a 24-bit word consisting of three 8-bit registers (high address is the MSB). The offset value is left-justified to align to the 32-bit data. The offset value is 2's-complement coding with a maximum positive value of 7FFFFFFh and a maximum negative value of 800000h. OFFSET is subtracted from the conversion data; see [Table 8-8](#). Offset error is corrected by the offset calibration command with the input-short multiplexer option, or by collecting shorted-input ADC data and writing the value to the registers.

Although the offset correction range is from –FS to +FS, the sum of offset and gain correction must not exceed 106% of the uncalibrated range.

When the high-pass filter is enabled, offset correction is disabled. The offset value is used instead as a starting value to shorten the high-pass filter settling time. To reload the offset value to the HPF, disable and re-enable the high-pass filter. See the [HPF Stage](#) section for more details.

Table 8-8. Offset Calibration Values

OFFSET[31:0]	CALIBRATED OUTPUT CODE ⁽¹⁾
00007Fh	FFFF8100h
000000h	00000000h
FFFF7Fh	00008100h

(1) Ideal code value with no offset error.

8.4.6.2 GAIN Register

Gain correction is through a 24-bit word, consisting of three 8-bit registers (high address = MSB). The gain value is 24 bits, coded in straight binary and normalized to 1.0 for GAIN[23:0] equal to 400000h. With a calibration signal applied, gain error is calibrated by either the gain calibration command, or by collecting ADC data and writing a computed value to the gain registers. [Table 8-9](#) lists examples of the GAIN[23:0] register values. Although the range of gain values can be much greater or less than 1, the sum of offset and gain correction must not exceed 106% of the uncalibrated range.

表 8-9. Gain Calibration Values

GAIN[31:0]	GAIN CORRECTION FACTOR
433333h	1.05
400000h	1.00
3CCCCCh	0.95

8.4.6.3 Calibration Procedure

ADC calibration can be performed using the ADC calibration commands or by performing manual calibration. The calibration procedure is as follows:

- Select the PGA or buffer operation, input channel, and PGA gain condition for calibration.
- Preset the OFFSET register = 000000h and the GAIN register = 400000h.
- Disable the high-pass filter for offset calibration. Short the inputs to the system, or use the input MUX to provide the input short. A system-level input short can yield more accurate calibration. After the input settles, either send the OFSCAL command or perform a manual calibration.
 - OFSCAL command. After the command is sent, $\overline{\text{DRDY}}$ is driven low 81 conversion periods later to indicate calibration is complete. The OFFSET register is updated with the new calibration value. As shown in [Figure 8-21](#), the first data output uses the new OFFSET value.
 - Manual calibration. Wait at least 64 conversions for the digital filter to settle then average a number of data points to improve calibration accuracy. Write the value to the 24-bit OFFSET register.
- Apply a gain calibration voltage. After the input settles, either send the GANCAL command or perform a manual calibration.
 - GANCAL command. Apply a positive dc full-scale calibration voltage. After the command is sent, $\overline{\text{DRDY}}$ is driven low 81 conversion periods later to indicate calibration is complete. The ADC calculates GAIN such that the full-scale code is equal to the applied calibration signal. As shown in [Figure 8-21](#), the first data output uses the new GAIN value.
 - Manual calibration. Apply an ac signal coherent to the sample rate or dc calibration signal that are slightly below full-scale (for example, 2.4 V for gain = 1). Using a calibration signal less than full-scale range prevents clipped output codes that otherwise lead to incorrect calibration. Wait 64 conversions for the digital filter to settle then average a number of data points to improve calibration accuracy. For ac-signal calibration, use a number of coherent signal periods to compute the RMS value.

[Equation 7](#) computes the value of GAIN for manual calibration.

$$\text{GAIN}[23:0] = 400000\text{h} \cdot \frac{\text{Expected Output Code}}{\text{Actual Output Code}} \quad (7)$$



图 8-21. Calibration Command

8.5 Programming

8.5.1 Serial Interface

Conversion data are read and ADC configuration is made through the SPI-compatible serial interface. The interface consists of four signals: \overline{CS} , SCLK, DIN, and DOUT. \overline{DRDY} asserts low when conversion data are ready. The serial interface is passive (peripheral mode), where the serial clock (SCLK) is an input. The ADC operates in SPI mode 0, where CPOL = 0 and CPHA = 0. In mode 0, SCLK idles low and data are updated on the SCLK falling edges and are read on the SCLK rising edges.

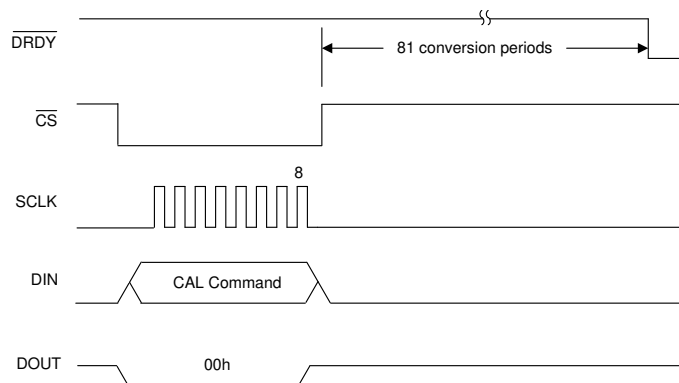
8.5.1.1 Chip Select (\overline{CS})

\overline{CS} is an active-low input that selects the serial interface for communication. A communication frame is started by taking \overline{CS} low and is ended by taking \overline{CS} high. Because only one command per frame is permitted, toggle \overline{CS} between commands. Taking \overline{CS} high before the command is completed resets the operation and blocks further SCLK inputs. \overline{CS} high forces DOUT to a high-impedance state. \overline{DRDY} remains active regardless of the state of \overline{CS} .

8.5.1.2 Serial Clock (SCLK)

SCLK is the serial clock input that shifts data into and out of the ADC. The ADC latches DIN data on the rising edge of SCLK. DOUT data are shifted out on the falling edge of SCLK. Keep SCLK low when not active. The SCLK pin is a Schmidt-trigger input that reduces sensitivity to SCLK noise. However, keep the SCLK signal as noise free as possible to prevent inadvertent shifting of the data.

8.5.1.3 Data Input (DIN)

DIN is used to input data to the ADC. DIN data are latched on the rising edge of SCLK.

8.5.1.4 Data Output (DOUT)

DOUT is the data output pin. Data are shifted out on the falling edge of SCLK and are latched by the host on the rising edge. Because the conversion data MSB is on DOUT when \overline{CS} is driven low (\overline{DRDY} low), the MSB of the data is read on the first rising edge of SCLK. Minimize trace length to reduce load capacitance on the pin. Place a series termination resistor close to the pin to terminate the PCB trace impedance. Taking \overline{CS} high forces DOUT to a high-impedance state.

8.5.1.5 Data Ready (\overline{DRDY})

\overline{DRDY} is an active-low output that indicates conversion data are ready. \overline{DRDY} is active regardless of the state of \overline{CS} . \overline{DRDY} is driven high on the first falling edge of SCLK, regardless if data is being read or a command is input. As shown in [Figure 8-22](#), if data are not retrieved, \overline{DRDY} pulses high for eight f_{CLK} periods.

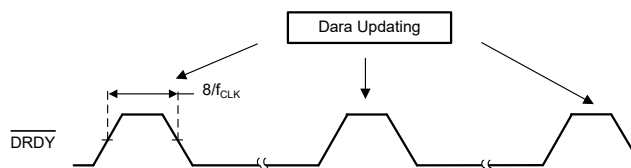

Figure 8-22. \overline{DRDY} With No Data Retrieval

8.5.2 Conversion Data Format

As listed in 表 8-10, the conversion data are coded in 32-bit, 2's-complement format to represent positive and negative numbers. If desired, the data read operation can be shortened to 24 bits by taking \overline{CS} high. Data scaling from the Sinc filter is dependent on the value of V_{REF} and whether PGA or buffer operation.

表 8-10. Output Data Format

V_{IN} (V)	CONVERSION CODES ⁽¹⁾			
	FIR FILTER	SINC FILTER ⁽²⁾		
	$V_{REF} = 2.5\text{ V}, 4.096\text{ V}$ or 5 V	$V_{REF} = 2.5\text{ V}$	$V_{REF} = 4.096\text{ V}$	$V_{REF} = 5\text{ V}$
$\geq 2.5\text{ V} \times (2^{31} - 1) / 2^{31} / \text{Gain}$	7FFFFFFFh	3FFFFFFFh	3A980000h	30000000h
$2.5\text{ V} / (\text{Gain} \times (2^{31} - 1))$	00000001h	<00000001h	<00000001h	<00000001h
0	00000000h	00000000h	00000000h	00000000h
$-2.5\text{ V} / (\text{Gain} \times 2^{31})$	FFFFFFFFh	>FFFFFFFFh	>FFFFFFFFh	>FFFFFFFFh
$\leq -2.5\text{ V} / \text{Gain}$	80000000h	C0000000h	C5680000h	D0000000h

- (1) Excluding the effects of reference voltage error, noise, linearity, offset, and gain errors.
(2) In buffer operation when $V_{REF} = 4.096\text{ V}$ or 5 V , the data from the sinc filter are scaled 66.6% compared to PGA mode. Because of the relatively low value of OSR, full 32-bit resolution is not available in sinc filter operation. When overdriven, the sinc filter continues to output code values beyond nominal \pm full-scale until the point of modulator saturation.

8.5.3 Commands

表 8-11 lists the commands for the ADC. Most commands are one byte in length. However, the number of bytes for the register read and write commands depend on the amount of register data specified in the command.

表 8-11. Command Descriptions

MNEMONIC	TYPE	DESCRIPTION	BYTE 1 ⁽¹⁾	BYTE 2
WAKEUP	Control	Wake from standby mode or NOP	0000 000x (00h or 01h)	—
STANDBY	Control	Enter standby (software power-down mode)	0000 001x (02h or 03h)	—
SYNC	Control	Synchronize	0000 010x (04h or 05h)	—
RESET	Control	Reset	0000 011x (06h or 07h)	—
RDATA	Data	Read conversion data	0001 0010 (12h)	—
RREG	Register	Read <i>nnnn</i> registers beginning at address <i>rrrr</i>	0010 <i>rrrr</i> (20h + <i>rrrr</i>) ⁽²⁾	0000 <i>nnnn</i> (00h + <i>nnnn</i>) ⁽³⁾
WREG	Register	Write <i>nnnn</i> registers beginning at address <i>rrrr</i>	0100 <i>rrrr</i> (40h + <i>rrrr</i>) ⁽²⁾	0000 <i>nnnn</i> (00h + <i>nnnn</i>) ⁽³⁾
OFSCAL	Calibration	Offset calibration	0110 0000 (60h)	—
GANCAL	Calibration	Gain calibration	0110 0001 (61h)	—

- (1) x = Don't care.
(2) *rrrr* = Starting address for register read and write commands.
(3) *nnnn* = Number of registers to be read or written – 1. For example, to read or write three registers, *nnnn* = 2.

8.5.3.1 Single Byte Command

图 8-23 shows the general format of a single byte command (for the response bytes of the RDATA command, see the RDATA command).



图 8-23. Single Byte Command Format

8.5.3.2 WAKEUP: Wake Command

The WAKEUP command exits standby mode to resume normal operation. If the ADC is already powered, the command is no operation (NOP). When exiting standby mode, the ADC requires resynchronization. See the [Power-Down Mode](#) section for details of power-down mode.

8.5.3.3 STANDBY: Software Power-Down Command

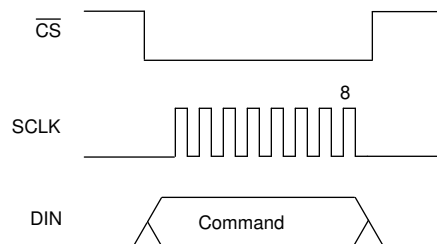
The STANDBY command enters the software power-down mode. The ADC exits software power-down mode by the WAKEUP command. See the [Power-Down Mode](#) section for details of power-down mode.

8.5.3.4 SYNC: Synchronize Command

The SYNC command synchronizes the ADC. Synchronization occurs at the eighth bit of the SYNC command byte. When synchronized, the current conversion is stopped and restarted. In order to synchronize multiple ADCs by software command, send the command simultaneously to all devices. The SYNC pin must be high when using the command. See the [Synchronization](#) section for details of synchronization.

8.5.3.5 RESET: Reset Command

The RESET command resets the ADC. See the [Reset](#) section for details of the reset operation.

8.5.3.6 Read Data Direct

There are two methods in which to read conversion data: read data direct and read data by command.

Read data direct does not require a command, instead after $\overline{\text{DRDY}}$ falls low, simply apply SCLK to read the data. [Figure 8-24](#) shows the read data direct operation. When $\overline{\text{DRDY}}$ falls low, take $\overline{\text{CS}}$ low to start the read operation. $\overline{\text{CS}}$ low causes DOUT to transition from tri-state mode to the output of the data MSB. Data are read on the rising edge of SCLK and updated on the falling edge of SCLK. $\overline{\text{DRDY}}$ returns high on the first falling edge of SCLK. DOUT is low after 32 data bits are read. To read the same data again before new data are available, use the RDATA command.

Keep DIN low when reading conversion data. If the RDATA (read conversion data) or RREG (read register data) command is sent, output data are interrupted in response to the command. If $\overline{\text{DRDY}}$ falls low during the read operation, the new data are lost unless a minimum of three bytes of the old data are read.

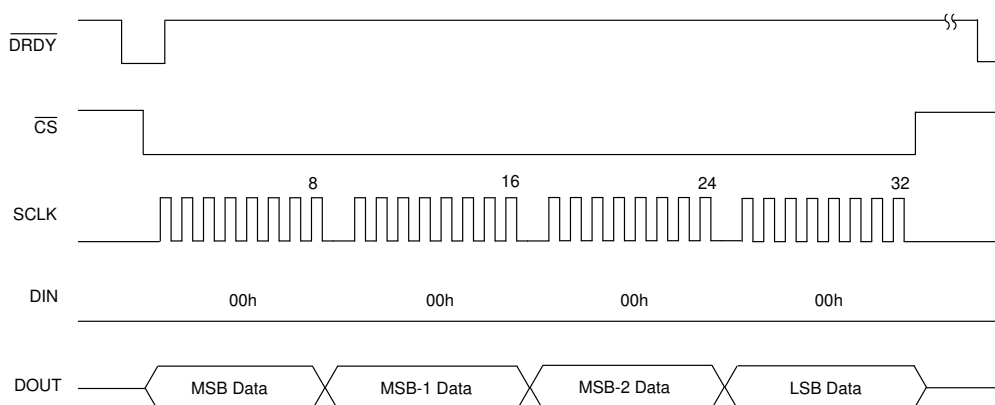
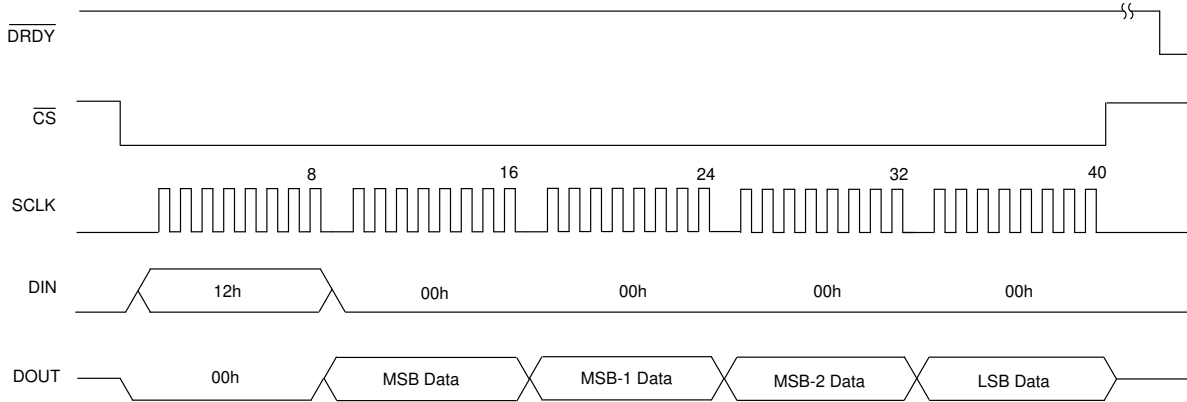

Figure 8-24. Read Data Direct

8.5.3.7 RDATA: Read Conversion Data Command

The RDATA command ([Figure 8-25](#)) is useful to re-read data within the same conversion period or to read data interrupted by a read register command. In both cases, $\overline{\text{DRDY}}$ is high because $\overline{\text{DRDY}}$ is driven high on the first SCLK of the previous operation. If $\overline{\text{DRDY}}$ is high, the first output byte is zero followed by data. If low, the first output byte is byte 1 of the conversion data, which is restarted for output byte 2.



8-25. Read Conversion Data by Command

8.5.3.8 RREG: Read Register Command

The RREG command reads register data. The command is comprised of two bytes followed by output of the designated number of register bytes. The ADC auto-increments the address up to the number of registers specified in byte 2 of the command. The incrementing address does not wrap. The first byte of the command is the opcode added to the register starting address, and the second byte is the number of registers to read minus one.

- First command byte: 0010 *rrrr*, where *rrrr* is the starting register address
- Second command byte: 0000 *nnnn*, where *nnnn* is the number of registers to read minus one

8-26 shows an example of a three-register read operation starting at register address 01h. The first register data appears on DOUT at the 16th falling edge of SCLK. The data are latched on the rising edge of SCLK.

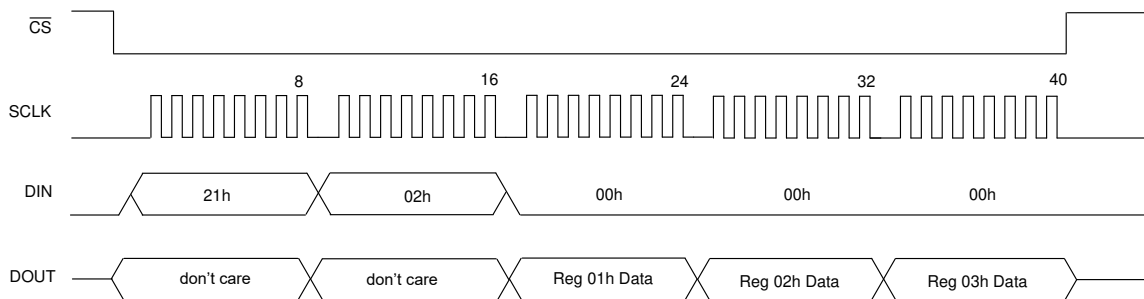

8-26. Read Register Data

8.5.3.9 WREG: Write Register Command

The WREG command is used to write register data. The command is two bytes followed by the designated number of register bytes to be written. The ADC auto-increments the address up to the number of registers specified in the command. The incrementing address does not wrap. The first byte of the command is the opcode added to the register starting address, and the second byte is the number of registers to write minus one.

First command byte: 0100 *rrrr*, where *rrrr* is the starting address of the first register.

Second command byte: 0000 *nnnn*, where *nnnn* is the number of registers to write minus one.

Data bytes: Depending on the number of registers specified.

✕ 8-27 shows an example of a three-register write operation starting at register address 01h.

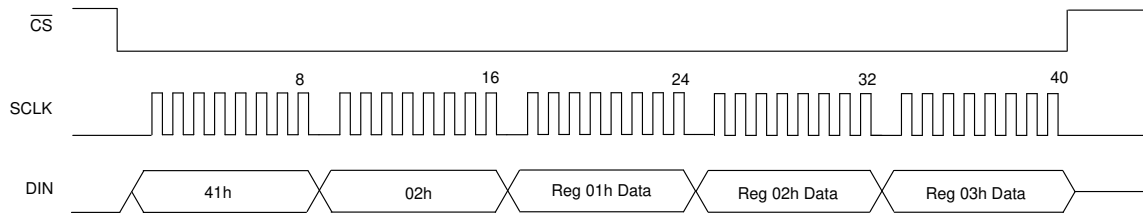

✕ 8-27. Write Register Data

8.5.3.10 OFSCAL: Offset Calibration Command

The OFSCAL command performs offset calibration. See the [Calibration Procedure](#) section for details of operation.

8.5.3.11 GANCAL: Gain Calibration Command

The GANCAL command performs a gain calibration. See the [Calibration Procedure](#) section for details of operation.

8.6 Register Map

Collectively, the registers contain all the information needed to configure the device (such as data rate, filter mode, specific reference voltage, and so on). The registers are accessed by the read and write commands (RREG and WREG). Registers can be accessed individually, or accessed in multiples given by the number of registers specified in the command field.

Changes made to certain register bits result in a filter reset, thus requiring resynchronization of the ADC. See the [Synchronization](#) section for details.

表 8-12. Register Map

ADDRESS	REG LINK	RESET	BIT 7	BIT 6	BIT 5	BIT 4	BIT 3	BIT 2	BIT 1	BIT 0	
00h	ID/SYNC	xxxx0000b	REVID[3:0]			DEVID[2:0]			SYNC		
01h	CONFIG0	00010010b	MODE[1:0]		DR[2:0]			PHASE	FILTR[1:0]		
02h	CONFIG1	00000000b	MUX[2:0]			REF[1:0]		GAIN[2:0]			
03h	HPF0	00110010h	HPF[7:0]								
04h	HPF1	00000011b	HPF[15:8]								
05h	OFFSET0	00000000b	OFFSET[7:0]								
06h	OFFSET1	00000000b	OFFSET[15:8]								
07h	OFFSET2	00000000b	OFFSET[23:16]								
08h	GAIN0	00000000b	GAIN[7:0]								
09h	GAIN1	00000000b	GAIN[15:8]								
0Ah	GAIN2	01000000b	GAIN[23:16]								
0Bh	GPIO	000xx000b	RESERVED			GPIO1_DAT	GPIO0_DAT	GPIO1_DIR	GPIO0_DIR	RESERVED	
0Ch	SRC0	00000000b	SRC[7:0]								
0Dh	SRC1	10000000b	SRC[15:8]								

8.6.1 Register Descriptions

表 8-13 shows the register access codes for the ADS1285 registers.

表 8-13. ADS1285 Access Codes

Access Type	Code	Description
R	R	Read
R-W	R/W	Read or write
W	W	Write
-n		Value after reset or the default value

8.6.1.1 ID/SYNC: Device ID, SYNC Register (Address = 00h) [Reset = xxxx0000b]

图 8-28. ID/SYNC Register

7	6	5	4	3	2	1	0
REVID[3:0]				DEVID[2:0]			SYNC
R-xxxxb				R-000b			R/W-0b

表 8-14. ID/SYNC Register Field Descriptions

Bit	Field	Type	Reset	Description
7:4	REVID[3:0]	R	xxxxb	Factory-programmed die revision. These bits identify the revision of the die. The die revision is subject to change without notification.
3:1	DEVID[2:0]	R	000b	Factory-programmed device identification. These bits identify the ADC. 000b = ADS1285
0	SYNC	R/W	0b	Synchronization mode selection. See the Synchronization section for details. 0b = Pulse-sync mode 1b = Continuous-sync mode

8.6.1.2 CONFIG0: Configuration Register 0 (Address = 01h) [Reset = 12h]

图 8-29. CONFIG0 Register

7	6	5	4	3	2	1	0
MODE[1:0]		DR[2:0]			PHASE	FILTR[1:0]	
R/W-00b		R/W-010b			R/W-0b	R/W-10b	

表 8-15. CONFIG0 Register Field Descriptions

Bit	Field	Type	Reset	Description
7:6	MODE[1:0]	R/W	00b	Power mode selection. See the Power Modes section for details. 00b = High 01b = Mid 10b = Low 11b = Reserved
5:3	DR[2:0]	R/W	010b	Data rate selection. See the Digital Filter section for details. 000b = 250 SPS (125 SPS in low-power mode) 001b = 500 SPS (250 SPS in low-power mode) 010b = 1000 SPS (500 SPS in low-power mode) 011b = 2000 SPS (1000 SPS in low-power mode) 100b = 4000 SPS (2000 SPS in low-power mode) 101b–111b = Reserved
2	PHASE	R/W	0b	FIR filter phase selection. See the Digital Filter section for details. 0b = Linear phase 1b = Minimum phase
1:0	FILTR[1:0]	R/W	10b	Digital filter configuration. See the Digital Filter section for details. 00b = Reserved 01b = Sinc filter output 10b = FIR filter output 11b = FIR + IIR filter output

8.6.1.3 CONFIG1: Configuration Register 1 (Address = 02h) [Reset = 00h]

图 8-30. CONFIG1 Register

7	6	5	4	3	2	1	0
MUX[2:0]			REF[1:0]		GAIN[2:0]		
R/W-000b			R/W-00b		R/W-000b		

表 8-16. CONFIG1 Register Field Descriptions

Bit	Field	Type	Reset	Description
7:5	MUX[2:0]	R/W	000b	Input MUX selection. See the Analog Input section for details. 000b = Input 1 001b = Input 2 010b = Internal short with a 400-Ω resistor 011b = Input 1 and input 2 100b = Reserved 101b = Internal short with a 0-Ω resistor 110b, 111b = Reserved
4:3	REF[1:0]	R/W	00b	Select reference voltage operation. See the Voltage Reference Input section for details. 00b = 5 V 01b = 4.096 V 10b = 2.5 V 11b = Reserved
2:0	GAIN[2:0]	R/W	000b	PGA gain selection. See the PGA and Buffer section for details. 000b = 1 001b = 2 010b = 4 011b = 8 100b = 16 101b = 32 110b = 64 111b = Buffer operation

8.6.1.4 HPF0, HPF1: High-Pass Filter Registers (Address = 03h, 04h) [Reset = 32h, 03h]

图 8-31. HPF0 Register

7	6	5	4	3	2	1	0
HPF[7:0]							
R/W-32h							

图 8-32. HPF1 Register

7	6	5	4	3	2	1	0
HPF[15:8]							
R/W-03h							

表 8-17. HPF0, HPF1 Registers Field Description

Bit	Field	Type	Reset	Description
15:0	HPF[15:0]	R/W	0332h	High-pass filter programming. These registers program the corner frequency of the high-pass filter. See the HPF Stage section for details.

8.6.1.5 OFFSET0, OFFSET1, OFFSET2: Offset Calibration Registers
(Address = 05h, 06h, 07h) [Reset = 00h, 00h, 00h]

☒ 8-33. OFFSET0 Register

7	6	5	4	3	2	1	0
OFFSET[7:0]							
R/W-00h							

☒ 8-34. OFFSET1 Register

7	6	5	4	3	2	1	0
OFFSET[15:8]							
R/W-00h							

☒ 8-35. OFFSET2 Register

7	6	5	4	3	2	1	0
OFFSET[23:16]							
R/W-00h							

表 8-18. OFFSET0, OFFSET1, OFFSET2 Registers Field Description

Bit	Field	Type	Reset	Description
23:0	OFFSET[23:0]	R/W	000000h	Offset calibration. These bits are the 24-bit offset calibration word. The format is 2's-complement coding. The ADC subtracts the value of offset from the conversion result prior to the gain calibration operation. See the Offset and Gain Calibration section for details.

8.6.1.6 GAIN0, GAIN1, GAIN2: Gain Calibration Registers
(Address = 08h, 09h, 0Ah) [Reset = 00h, 00h, 40h]

☒ 8-36. GAIN0 Register

7	6	5	4	3	2	1	0
GAIN[7:0]							
R/W-00h							

☒ 8-37. GAIN1 Register

7	6	5	4	3	2	1	0
GAIN[15:8]							
R/W-00h							

☒ 8-38. GAIN2 Register

7	6	5	4	3	2	1	0
GAIN[23:16]							
R/W-40h							

表 8-19. GAIN0, GAIN1, GAIN2 Registers Field Description

Bit	Field	Type	Reset	Description
23:0	GAIN[23:0]	R/W	400000h	Gain calibration. These bits are the 24-bit, gain calibration word. Gain calibration is straight binary coding. The register value is divided by 400000h (2 ²²) and multiplied with the conversion data. The gain operation occurs after the offset operation. See the Offset and Gain Calibration section for details.

8.6.1.7 GPIO: Digital Input/Output Register (Address = 0Bh) [Reset = 000xx000b]

图 8-39. GPIO Register

7	6	5	4	3	2	1	0
RESERVED		GPIO1_DAT		GPIO0_DAT	GPIO1_DIR	GPIO0_DIR	RESERVED
R/W-000b		R/W-xb		R/W-xb	R/W-0b	R/W-0b	R/W-0b

表 8-20. GPIO Register Field Descriptions

Bit	Field	Type	Reset	Description
7:5	RESERVED	R/W	000b	Always write 000b.
4	GPIO1_DAT	R/W	xb	GPIO1 data. See the GPIO section for details. 0b = GPIO1 is low 1b = GPIO1 is high
3	GPIO0_DAT	R/W	xb	GPIO0 data. 0b = GPIO0 is low 1b = GPIO0 is high
2	GPIO1_DIR	R/W	0b	GPIO1 direction. 0b = GPIO1 is an input 1b = GPIO1 is an output
1	GPIO0_DIR	R/W	0b	GPIO0 direction. 0b = GPIO0 is an input 1b = GPIO0 is an output
0	RESERVED	R/W	0b	Always write 0b.

8.6.1.8 SRC0, SRC1: Sample Rate Converter Registers (Address = 0Ch, 0Dh) [Reset = 00h, 80h]

图 8-40. SRC0 Register

7	6	5	4	3	2	1	0
SRC[7:0]							
R/W-00h							

图 8-41. SRC1 Register

7	6	5	4	3	2	1	0
SRC[15:8]							
R/W-80h							

表 8-21. SRC0, SRC1 Registers Field Description

Bit	Field	Type	Reset	Description
15:0	SRC[15:0]	R/W	8000h	Sample rate converter. These registers program the sample rate converter. See the Sample Rate Converter section for details of operation. 8000h = SRC function is disabled

9 Application and Implementation

注

以下のアプリケーション情報は、TI の製品仕様に含まれるものではなく、TI ではその正確性または完全性を保証いたしません。個々の目的に対する製品の適合性については、お客様の責任で判断していただくこととなります。お客様は自身の設計実装を検証しテストすることで、システムの機能を確認する必要があります。

9.1 Application Information

The ADS1285 is a high-resolution ADC designed for low-power seismic data acquisition equipment. Optimizing performance requires special attention to the support circuitry and printed-circuit board (PCB) layout. As much as possible, locate noisy circuit components (such as microcontrollers, oscillators, switching regulators, and so forth) away from the ADC input circuit components, reference voltage, and the ADC clock signal.

9.2 Typical Application

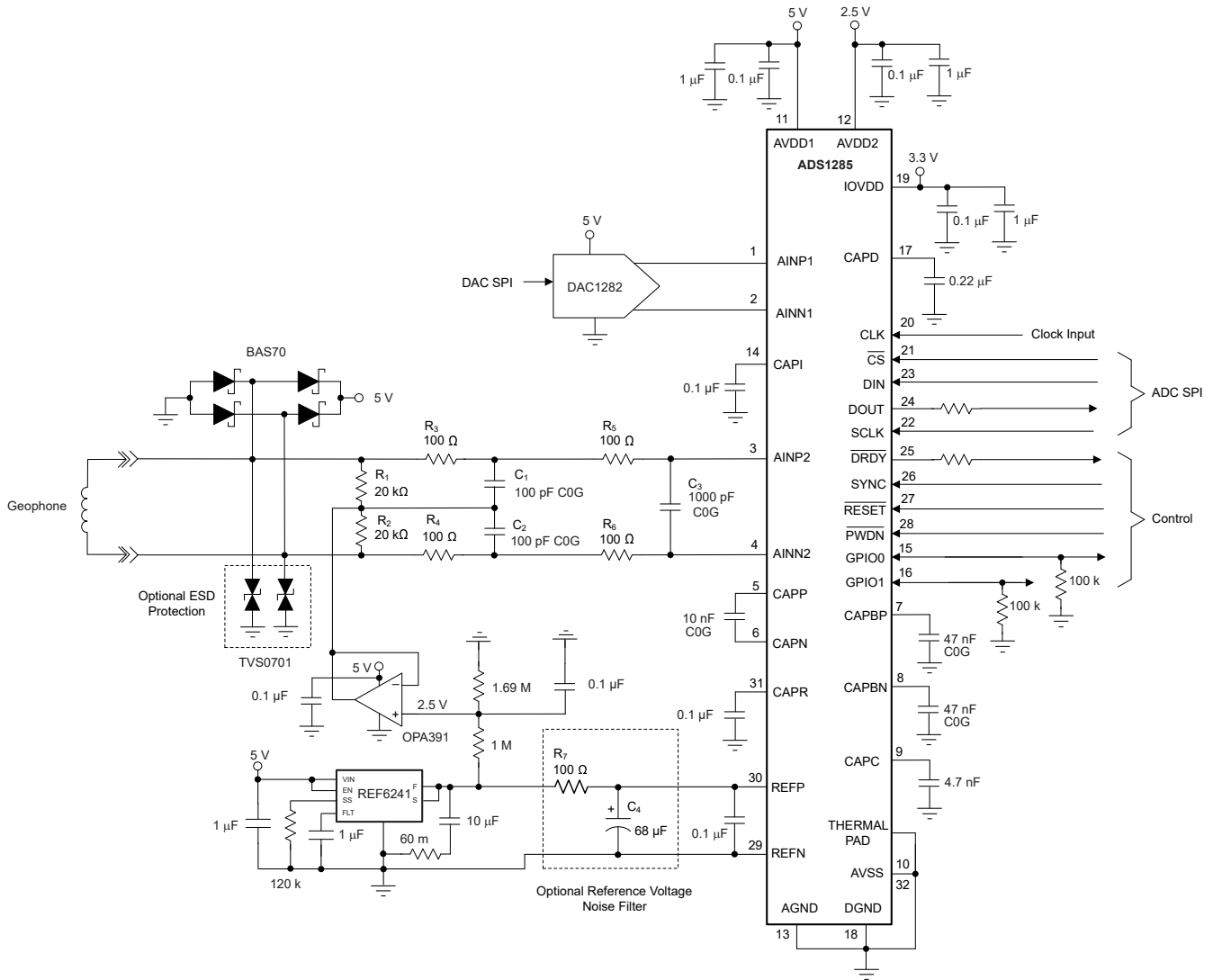

9-1. Geophone Input Application Example

9.2.1 Design Requirements

Figure 9-1 depicts a typical application of a geophone input circuit. The application shows the ADC operating with a 5-V power supply and a 2.5-V level-shift voltage applied to the ADC inputs. The goal of this evaluation is to analyze the effect of noise resulting from source resistance. The source resistance is the sum of the series input resistors and the geophone output resistance.

9.2.2 Detailed Design Procedure

Referring to Figure 9-1, Schottky diodes (BAS70 or equivalent) protect the ADC inputs from voltage overloads. The ADC inputs are protected from ESD events by the optional ESD protection diodes (TVS0701). The geophone signal is level-shifted to mid-supply by driving the input termination resistors (R_1 and R_2) common point to 2.5 V. The level-shift voltage is derived from the reference voltage and is buffered by the OPA391 op amp. The input termination resistors also provide the input bias current return path for the ADC inputs.

The input signal is filtered to reduce out-of-band noise. The filter is comprised of common-mode and differential sections. The common-mode section filters noise common to both inputs, consisting of R_3 , R_4 , C_1 , and C_2 . The differential section filters differential noise, consisting of R_3 through R_6 and C_3 . The resistor values are kept low to reduce thermal noise.

The REF6241 4.096-V voltage reference is used. The ADC must be programmed to match the value of the reference voltage. The optional noise filter consisting of R_7 and C_3 reduces reference noise. Resistor R_7 increases gain error resulting from the impedance of the reference input.

The AVDD1 power supply voltage = 5 V, with AVSS connected to AGND. The AVDD2 voltage is 2.5 V to minimize power consumption. If IOVDD = 1.8V, connect the CAPD pin to IOVDD.

Besides the power supply pins, place additional capacitors at certain pins. Capacitors are required between CAPP – CAPN, REFP – REFN, and at the CAPBP, CAPBN, CAPI, CAPR, CAPC, and CAPD pins with the capacitance values given in Figure 9-1. The CAPP – CAPN, CAPBP, and CAPBN capacitors are C0G type.

The DAC1282 provides a low-distortion signal to test THD performance, and through the DAC1282 dc test mode, test geophone impulse response. Increase the value of the DAC1282 capacitors CAPP and CAPN to 10 nF to optimize the ADS1285 THD test performance. See the [DAC1282 data sheet](#) for additional circuit details.

9.2.3 Application Curves

Table 9-1 lists the effect of source resistance (R_S) and device input current noise on dynamic range performance. Selected values of R_S and input current noise, obtained from the input current noise distribution of Figure 9-2 (1.5 pA/ $\sqrt{\text{Hz}}$ and 3 pA/ $\sqrt{\text{Hz}}$), are evaluated. Thermal noise voltage of the source resistance, input current noise \times source resistance, and ADC input-referred noise voltage are summed as RMS values to derive the total noise. Dynamic range is calculated from the total noise result.

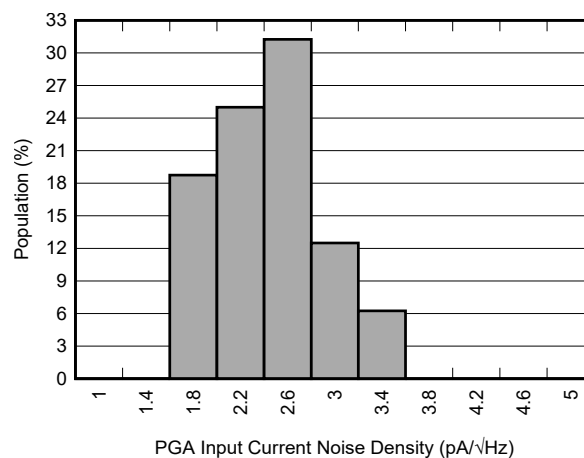

Figure 9-2. PGA Input Current Noise Distribution

表 9-1. Source Resistance Noise

R_S (Ω)	GAIN	i_n NOISE ($\text{pA}/\sqrt{\text{Hz}}$)	R_S NOISE (μV)	$i_n \times R_S$ NOISE (μV)	ADC SELF-NOISE (μV)	TOTAL NOISE (μV)	DR (dB)
0	1	1.5	0	0	0.44	0.44	132.1
		3		0		0.44	132.1
	16	1.5		0	0.11	0.11	120.1
		3		0		0.11	120.1
1000	1	1.5	0.06	0.024	0.44	0.445	132.0
		3		0.048		0.446	132.0
	16	1.5		0.024	0.11	0.127	118.8
		3		0.048		0.134	118.4
5000	1	1.5	0.13	0.11	0.44	0.472	131.5
		3		0.22		0.508	130.8
	16	1.5		0.11	0.11	0.202	114.8
		3		0.21		0.277	112.0

Data for the analysis is shown for low-power mode operation over a 206-Hz noise bandwidth ($f_{\text{DATA}} = 500$ SPS). For PGA gain = 1, 5000- Ω source resistance has a minor effect on dynamic range performance. However, at PGA gain = 16, dynamic range performance can degrade from -5 dB to -8 dB depending on the level of device input current noise. 1000- Ω source resistance has 1.6-dB degradation at gain = 16 for input current noise density = $3 \text{ pA}/\sqrt{\text{Hz}}$.

9.3 Power Supply Recommendations

The ADC has four power supplies: AVDD1, AVDD2, AVSS, and IOVDD. Among the power-supply options, the number of power supplies can be reduced to a single 3.3-V supply used for AVDD1, AVDD2, and IOVDD, with AVSS connected to ground. Be aware that 3.3-V operation limits the reference voltage to 2.5 V and requires using the buffer for gain = 1.

The power supplies can be sequenced in any order. The ADC is held in reset until the power supplies have crossed the retrospective power-on voltage thresholds and the clock signal is applied (see [Figure 6-8](#) for details of the voltage thresholds).

9.3.1 Analog Power Supplies

The ADC has three analog power supplies, AVDD1, AVDD2, and AVSS, all of which must be well regulated and free from switching power-supply noise (voltage ripple < 1 mV). The AVDD1 power-supply voltage is relative to AVSS and powers the PGA and buffer. AVSS is the negative power supply. The ADC can be configured for single-supply operation with AVDD1 = 5 V or 3.3 V with AVSS connected to ground. Because the minimum voltage of AVDD1 to AGND = 2.375 V, dual-supply operation is only possible when AVDD1 – AVSS = ± 2.5 V. Single-power supply operation requires a level-shift voltage at the geophone input through the input termination resistors. The level-shift voltage is typically equal to AVDD1 / 2. Bypass AVDD1 with 1- μF and 0.1- μF parallel capacitors to AVSS.

The AVDD2 power supply powers the modulator. To simplify system power management, AVDD2 can be connected AVDD1, regardless whether AVDD1 and AVSS are configured for single- or dual-supply operation (AVDD2 voltage range is 2.375 V to 5.25 V with respect to AGND). Bypass AVDD2 with 1- μF and 0.1- μF parallel capacitors to AGND.

9.3.2 Digital Power Supply

IOVDD is the digital power supply. IOVDD is the digital pin I/O voltage and also powers the digital core by an 1.8-V low-dropout regulator (LDO). The LDO output is the CAPD pin and is bypassed with a 0.22- μF capacitor to DGND. Do not externally load the CAPD voltage output. Bypass the IOVDD pin with 1- μF and 0.1- μF parallel capacitors to DGND.

If IOVDD is in the range of 1.65 V to 1.95 V, tie the IOVDD and CAPD pins together. This connection forces the internal LDO off, thereby the IOVDD voltage now directly powers the digital core. Pay close attention to the absolute maximum voltage rating of IOVDD driving the CAPD pin to avoid damaging the device.

9.3.3 Grounds

The ADC has two ground pins, AGND and DGND. Connect the AGND and DGND pins together at the ADC to a single ground plane using short direct connections.

9.3.4 Thermal Pad

The thermal pad does not carry device current but must be soldered and connected to the most negative power-supply voltage (AVSS). Because of the low power dissipation, PCB thermal vias can be omitted to provide space for bottom layer components under the device.

9.4 Layout

9.4.1 Layout Guidelines

Figure 9-3 shows the layout of the geophone input application example of Figure 9-1. In most cases, a single unbroken ground plane connecting the grounds of the analog and digital components is preferred. A four-layer PCB is used, with the inner layers dedicated for ground and power-supply planes. Low resistance power-supply planes are necessary to maintain THD performance.

Connect the REFN pin of the ADC directly to the ground terminal of the voltage reference to avoid ground noise coupling. Similarly, avoid ground noise between the tie-points of termination resistors R_1 and R_2 by connecting the resistors together first, then connect to ground (dual-supply operation).

Place the smaller of the parallel power-supply bypass capacitors closest to the device supply pins. The thermal pad of the package connects to the most negative power-supply voltage (AVSS). Figure 9-3 shows single-supply operation, with AVSS tied to AGND. In this case, the thermal pad connects to AGND. For dual-supply operation, connect the thermal pad to AVSS.

9.4.2 Layout Example

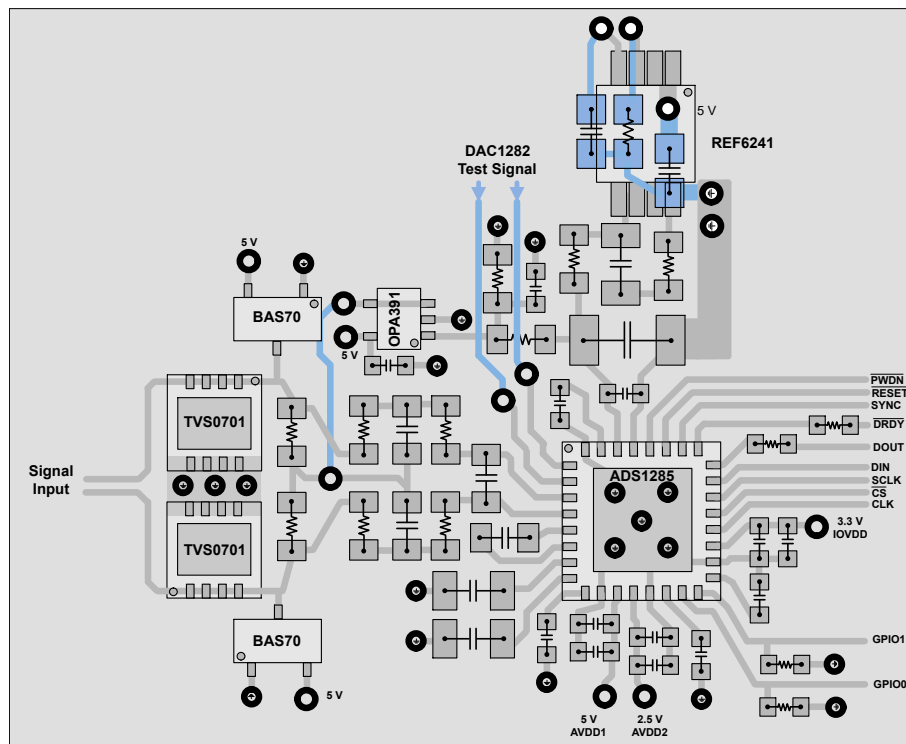

Figure 9-3. Example Layout

10 Device and Documentation Support

10.1 Receiving Notification of Documentation Updates

To receive notification of documentation updates, navigate to the device product folder on [ti.com](https://www.ti.com). Click on *Subscribe to updates* to register and receive a weekly digest of any product information that has changed. For change details, review the revision history included in any revised document.

10.2 サポート・リソース

[TI E2E™ サポート・フォーラム](#)は、エンジニアが検証済みの回答と設計に関するヒントをエキスパートから迅速かつ直接得ることができる場所です。既存の回答を検索したり、独自の質問をしたりすることで、設計に必要な支援を迅速に得ることができます。

リンクされているコンテンツは、該当する貢献者により、現状のまま提供されるものです。これらは TI の仕様を構成するものではなく、必ずしも TI の見解を反映したものではありません。TI の[使用条件](#)を参照してください。

10.3 Trademarks

TI E2E™ is a trademark of Texas Instruments.

すべての商標は、それぞれの所有者に帰属します。

10.4 Electrostatic Discharge Caution



This integrated circuit can be damaged by ESD. Texas Instruments recommends that all integrated circuits be handled with appropriate precautions. Failure to observe proper handling and installation procedures can cause damage.

ESD damage can range from subtle performance degradation to complete device failure. Precision integrated circuits may be more susceptible to damage because very small parametric changes could cause the device not to meet its published specifications.

10.5 Glossary

[TI Glossary](#) This glossary lists and explains terms, acronyms, and definitions.

11 Mechanical, Packaging, and Orderable Information

The following pages include mechanical, packaging, and orderable information. This information is the most current data available for the designated devices. This data is subject to change without notice and revision of this document. For browser-based versions of this data sheet, refer to the left-hand navigation.

TAPE AND REEL INFORMATION

QUADRANT ASSIGNMENTS FOR PIN 1 ORIENTATION IN TAPE

*All dimensions are nominal

Device	Package Type	Package Drawing	Pins	SPQ	Reel Diameter (mm)	Reel Width W1 (mm)	A0 (mm)	B0 (mm)	K0 (mm)	P1 (mm)	W (mm)	Pin1 Quadrant
ADS1285IRHBR	VQFN	RHB	32	3000	330.0	12.4	5.3	5.3	1.1	8.0	12.0	Q2
ADS1285IRHBT	VQFN	RHB	32	250	180.0	12.4	5.3	5.3	1.1	8.0	12.0	Q2

TAPE AND REEL BOX DIMENSIONS

*All dimensions are nominal

Device	Package Type	Package Drawing	Pins	SPQ	Length (mm)	Width (mm)	Height (mm)
ADS1285IRHBR	VQFN	RHB	32	3000	367.0	367.0	35.0
ADS1285IRHBT	VQFN	RHB	32	250	210.0	185.0	35.0

重要なお知らせと免責事項

TI は、技術データと信頼性データ (データシートを含みます)、設計リソース (リファレンス・デザインを含みます)、アプリケーションや設計に関する各種アドバイス、Web ツール、安全性情報、その他のリソースを、欠陥が存在する可能性のある「現状のまま」提供しており、商品性および特定目的に対する適合性の黙示保証、第三者の知的財産権の非侵害保証を含むいかなる保証も、明示的または黙示的にかかわらず拒否します。

これらのリソースは、TI 製品を使用する設計の経験を積んだ開発者への提供を意図したものです。(1) お客様のアプリケーションに適した TI 製品の選定、(2) お客様のアプリケーションの設計、検証、試験、(3) お客様のアプリケーションに該当する各種規格や、その他のあらゆる安全性、セキュリティ、規制、または他の要件への確実な適合に関する責任を、お客様のみが単独で負うものとし、

上記の各種リソースは、予告なく変更される可能性があります。これらのリソースは、リソースで説明されている TI 製品を使用するアプリケーションの開発の目的でのみ、TI はその使用をお客様に許諾します。これらのリソースに関して、他の目的で複製することや掲載することは禁止されています。TI や第三者の知的財産権のライセンスが付与されている訳ではありません。お客様は、これらのリソースを自身で使用した結果発生するあらゆる申し立て、損害、費用、損失、責任について、TI およびその代理人を完全に補償するものとし、TI は一切の責任を拒否します。

TI の製品は、[TI の販売条件](#)、または [ti.com](https://www.ti.com) やかかる TI 製品の関連資料などのいずれかを通じて提供する適用可能な条項の下で提供されています。TI がこれらのリソースを提供することは、適用される TI の保証または他の保証の放棄の拡大や変更を意味するものではありません。

お客様がいかなる追加条項または代替条項を提案した場合でも、TI はそれらに異議を唱え、拒否します。

郵送先住所 : Texas Instruments, Post Office Box 655303, Dallas, Texas 75265
Copyright © 2023, Texas Instruments Incorporated